

The Journal of Borderland Research

Vol. XLVII, No. 3

May-June 1991

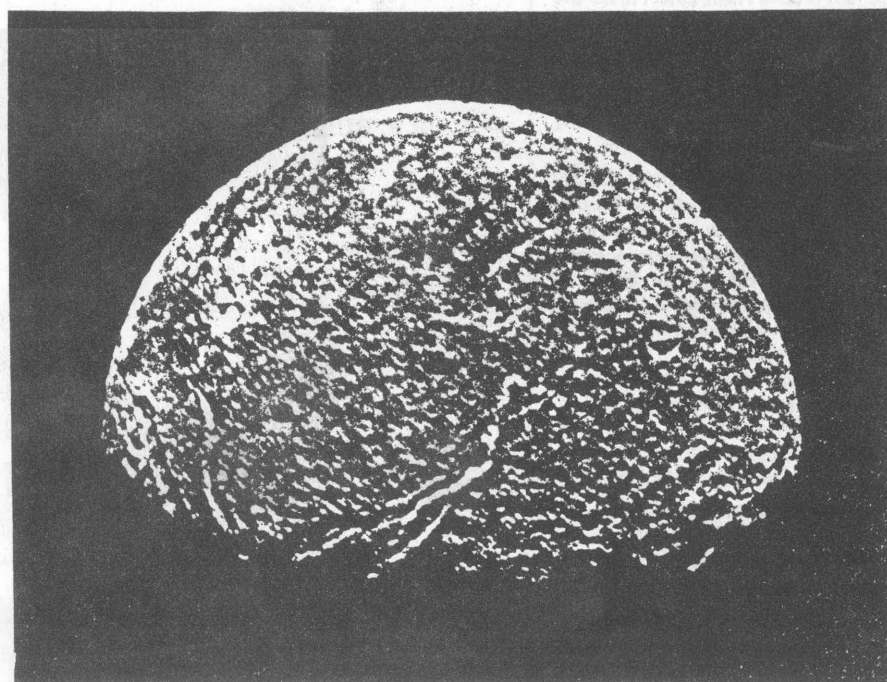

TITANIA, SATELLITE OF URANUS

THE JOURNAL OF BORDERLAND RESEARCH (ISSN 0897-0394) is a publication of Borderland Sciences Research Foundation, Inc., P.O. Box 429, Garberville, California 95440-0429 USA. Phone: (707) 986-7211, Fax: (707) 986-7272. Contents are ©1991 by BSRF, Inc. The Journal is published six issues a year (bi-monthly) with the assistance of the BSRF Associates. The Journal is issued to members of BSRF.

EDITOR-IN-CHIEF

Thomas Joseph Brown

MANAGING EDITOR

Michael Theroux

PRODUCTION ASSISTANT

Yerba Santa

CONTRIBUTING EDITORS

Alison Davidson

Peter Lindemann

Jorge Resines

THE JOURNAL OF BORDERLAND RESEARCH is a Free-Thought Scientific Forum using the imagination and intuition to probe beyond the borders of human perceptions. Donations of pertinent materials are accepted for publication in this Journal.

BORDERLAND SCIENCES RESEARCH FOUNDATION, Inc. is a non-profit organization of people who take an active interest in observation of their physical, mental and spiritual environment - personally, globally, and universally. Subjects of inquiry on this Borderland between the Visible and Invisible Manifestations of Reality include: Archetypal Forms and Forces of Nature and the Use of the Imagination and Intuition to Perceive Them, Ether Physics and Etherial Forces, Light and Color, Radionics and Radiesthesia, Dowsing, Orgone Energy, Nikola Tesla & The Electrical Sciences, Viktor Schauburger & Water Technology, Octaves of the Elements, Electricity & The Evolving Soul, Initiation Science & Advanced Human Perceptions, Hollow Earth Mysteries, Anomalies & Fortean Phenomena, Hypnosis, Photography of the Invisible, and Unidentified Flying Objects.

BORDERLAND SCIENCES RESEARCH FOUNDATION was founded by N. Meade Layne in February 1945 with the issuance of his first **ROUND ROBIN**, original title to **The Journal of Borderland Research**. **B.S.R.F.** is a non-profit foundation incorporated under California law, May 21, 1951. **The Board of Directors** is: Thomas Joseph Brown, President; Peter A. Lindemann, Vice-President; Michael Theroux, Secretary-Treasurer.

BSRF Membership fees are:

- \$25/year worldwide, Regular Membership
- \$15/year, Senior Citizen & Student Membership
- \$50/year, Supporting Membership
- \$100/year, Sustaining Membership
- \$1000, Lifetime Membership

Membership entitles you to *The Journal of Borderland Research* for the duration of your membership term. The *Journal* is sent bulk mail in the U.S. and ISAL overseas.

THE MAIN fundraising activity of BSRF is to act as an educational clearinghouse for information, and to actively seek donations to fund our activities. Active research is being carried out by BSRF Members and results are published in *The Journal of Borderland Research*. The funding for BSRF comes from the sales of research materials, membership fees and donations.

ALL PUBLISHED MATERIAL is presented for Informational and Research purposes only. These are the published records of researches within the vast "borderland" framework. Authors are solely responsible for the information and opinions they present. In no way are BSRF publications, books or equipment to be taken as medical advice or instrumentation. We fully support a person's natural right to research and investigate for themselves, but wish to add that all research must be undertaken with a clear, responsible approach. BSRF functions on the Universal Principle of the Free Flow of Information.

The Journal of Borderland Research

Volume XLVII, No. 3

May-June 1991

TABLE OF CONTENTS

- * **OPERATION CLINCHER**
A B.S.R.F. Special Report [1-10]
- * **SACRAMENTAL THINKING**
Joel A. Wendt [11]
- * **URANUS AND THE RADIOACTIVE METALS**
Alison Davidson [12-16]
- * **THE WORLD RUNS ON AC**
Larry Spring [17]
- * **THE SPIRAL COIL MULTI-WAVE OSCILLATOR Part II**
Louis A. Schad [18-20]
- * **B.S.R.F. BULLETIN BOARD** [21-29]

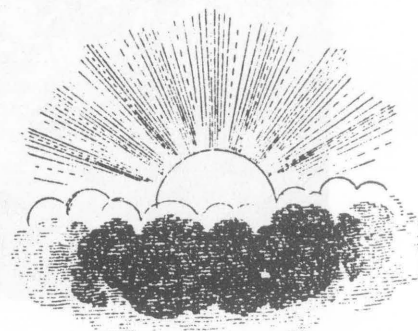

Seasonal Smog Reduction Southern California 1990

OPERATION CLINCHER

A B.S.R.F. Special Report compiled and edited by Tom Brown
with special thanks to Trevor James Constable, Irwin Trent
and TJC/Atmos Pte., Singapore.

OPERATION CLINCHER was the climactic operation in a series of four etheric weather engineering projects, carried out by Trevor Constable and his TJC/ATMOS group, aimed at air pollution reduction in southern California. As required by law, all the projects were filed in advance of commencement with the National Oceanic and Atmospheric Administration, Rockville, Maryland.

CLINCHER developed out of Trevor's original operational experience with vertical ether currents. Simple geometric apparatus was designed to generate etheric vortices which can subsequently influence the atmosphere. This phase of weather engineering began early in 1987, on the high seas aboard a large, fast-moving ocean-going vessel.

Promising mobile maritime experience justified a fixed-base operation in southern California in the summer of 1987, code-named VICTOR. This operation was a striking success against smog. Significant ozone reduction resulted, together with the cleanest air seen in the region since the start of the smog records. There were unforeseen consequences, for which there had been no malefic intent, but which provided forceful, objective evidence of VICTOR'S efficacy.

A \$10 million smog study project, mounted in the summer of 1987 by the California State Air Resources Board, was completely nullified by the simultaneous VICTOR operations. The scientists who had come to southern California for the study, from all over the U.S. and from other countries, were sent home because there wasn't enough smog for them to gather statistically valid samples. The most ambitious official smog study program ever launched was an ignominious failure. An effective anti-smog modality had come on the scene from "left field", and history was in the making. \$10 million in public funds to study smog, \$4,000 out of TJC's pocket to eliminate it!

The TJC/ATMOS group stood down from all southern California operations in 1988, during which time Project TANGO was un-

dertaken in Singapore (reported in Sept-Oct 1989 JBR). Smog levels were permitted to 'normalize' that year -- to develop without any countering influence from etheric weather engineering. The stand-down was a necessary and valuable counter to the official assessment of 1987's dramatically low smog as due to a meteorological fluke.

1988 returned the smog season to 1986 levels, with 77 Alert-Days -- up almost 17% from 1987.

In 1989, TJC/ATMOS returned to the southern California scene. BREAKTHROUGH was mounted in July, and CHECKER followed on in September and October. ATMOS totalled three months weather engineering operations during the six month smog season, which runs from 1 May to 31 October. Financing was now being provided by a successful young Singapore entrepreneur, Mr. George K.C. Wu, who is also a BSRF member. This took a lot of strain off the aging ATMOS warriors, who financed all previous operations out of pocket.

In 1989, operations provided a sparkling reprise of the VICTOR scenario. Smog was yet again reduced to all-time record low levels. Two all-time record low smog levels were recorded in two ATMOS involvements, 1987 and 1989.

This operational sequencing provided typical ON/OFF statistical evidence. Official seasonal smog status for comparison purposes is assessed via the number of Alert-Days in a season. An Alert-Day is one on

which there is a First Stage Smog Alert anywhere in the South Coast Air Quality Management District, hereinafter the AQMD. A 1st Stage Alert is called whenever ozone at any monitoring station reaches .20 parts per million. There are 37 official monitoring stations in the AQMD, which covers four counties.

In brief summary, the ON/OFF statistical evidence preceding CLINCHER is as follows:

1986, ATMOS OUT.

The only ATMOS operation in 1986 was OPERATION PINCER II in July 1986, exclusively for rain engineering and utilizing a different technology than is required for smog operations (see Jan-Feb 1987 JBR).

1986 was a normal smog season. 79 Alert-Days.

1987, ATMOS IN.

OPERATION VICTOR, Phase 1, July 1

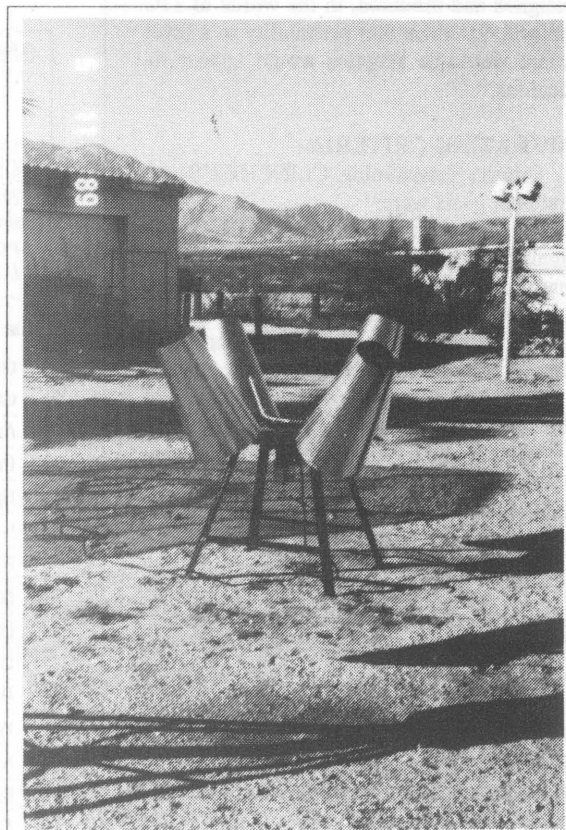

ETHERIC TECHNOLOGY

This is a November 1989 prototype "Spider" generator of etheric vortices, under test at Fort Zinderneuf in Desert Hot Springs, California. 14 similar units were employed in the 1990 smog season to dramatically reduce smog in the number and duration of smog Alerts to all-time lows. Goals and nature of CLINCHER were filed prior to smog season with National Oceanographic and Atmospheric Administration.

through August 9. Phase 2, 1-30 September. Produced the cleanest southern California air in 40 years. Lowest number of Alert-Days ever recorded (66). A 16% drop in Alert-Days from 1986. Termed a meteorological freak by smog officialdom. 66 Alert-Days.

1988, ATMOS OUT.

No operation. Return to 1986 levels of smog, and up 16% from 1987. 77 Alert-Days.

1989, ATMOS IN.

OPERATION BREAKTHROUGH in July. OPERATION CHECKER in September and October. Total engagement time, 3 months, or half the smog season. New all-time low number of Smog Alert-Days, 54, a 29% drop from 1988. 54 Alert-Days.

The correlation between ATMOS operations and smog levels by the end of the 1989 smog season thus already showed an extremely high degree of probability. CLINCHER was designed and mounted, in the words of TJC himself, "to raise that probability to a level where would-be skeptics would appear ridiculous."

OPERATING CRITERIA

Criteria determining CLINCHER'S operational goals were:

1. The margin under 1989 had to be significant, substantial and noteworthy. No marginal reduction that could be washed out by statistical manipulation would suffice. Unannounced changes in AQMD statistical bases are known to have occurred previously.

2. The combined Alert-Days reduction of the two successive ATMOS years, 1989 and 1990, had to be unprecedented in the history of the records, and to exceed by an inarguable margin, any other two successive non-ATMOS years in the records.

3. The reduction in Alert-Days from 1989 to 1990 should be larger than any previous year-to-year attrition in non-ATMOS years, when the AQMD was performing entirely on its own.

4. The CLINCHER reduction had to be feasible with available ATMOS resources. A 50% reduction was technologically feasible, but not financially possible with available funding and personnel.

5. The final result had to CLINCH the question of TJC/ATMOS influence over smog.

A 20% reduction in Alert-Days by CLINCHER was chosen as meeting these criteria.

NEW OPERATIONAL FACTORS

In the 1990 CLINCHER operation, success probability was enhanced by three factors not present previously:

1. At least SIX operating sites would be

used, 12-14 if available. A maximum of four had been used previously.

2. Operations would be conducted for the FULL SEASON for the first time, approximately doubling ATMOS leverage over smog.

3. Advances in effectiveness of equipment had been achieved since VICTOR in 1987, with a major technological advance after the 1989 season.

These factors were behind Trevor Constable publicly setting a 20% reduction as the project goal for CLINCHER. This projected reduction was posted in the Federal filing for CLINCHER, made with NOAA on 6 April 1990. Furthermore, RECORD SEASONAL REDUCTION OF REGIONAL SMOG was stated on the Federal Initial Report, as the purpose of the activity. No ifs, no waffling, no hedges. Smog was being challenged head-on.

This announcement of a further drastic smog reduction below the all-time record,

prior to project commencement, was an audacious commitment. Constable further made it public internationally by announcing it on Radio Free America, through whom it went all over the world on RFA's shortwave outlet (7.520 megacycles), and it was published in advance in this Journal (May-June 1990 JBR). He avoided all local and regional publicity at the same time, to minimize any possible "spoiler" activity.

No orthodox scientific body, no responsible bureaucracy or bureaucrat, has ever dared give the public this kind of commitment for effective air pollution reduction. The southern California smog bureaucracy had been plainly flabbergasted by the 29 percent Alert-Days reduction in 1989. The AQMD held no expectation that such a reduction would be REPEATED in 1990. Dr. James Lents, the executive director of AQMD, admitted at the 1990 mid-season AQMD press conference

SMOG SEASON

The 1990 smog season, which started May 1 and ended Wednesday, was the cleanest on record in the Los Angeles Basin, which includes Orange, Los Angeles, San Bernardino and Riverside counties. Air is measured daily in 37 cities. This chart reports the number of smog alert days in selected cities. Officials say recent rules forcing cutbacks in emissions from industry and autos get most of the credit for the 24% basinwide improvement compared with 1989.

■ **SMOG ALERT DAYS**

City	1990	1989	1988	1987	1986	1985	1984
Glendora	28	37	54	51	70	68	67
Azusa	13	30	33	26	45	48	55
Pasadena	7	17	18	15	33	41	49
Upland	11	19	25	23	38	39	41
San Bernardino	7	22	31	27	41	30	36
Redlands	10	17	25	26	22	31	26
Norco	0	3	7	9	12	20	19
La Habra	4	5	2	6	8	13	14
Downtown L.A.	2	1	2	2	8	9	8
Reseda	0	5	4	2	5	9	6
West L.A.	0	1	2	1	1	4	5
Anaheim	0	4	1	3	1	11	5
El Toro	0	2	2	0	1	7	3
Costa Mesa	0	0	0	0	0	1	1
Long Beach	0	0	0	0	0	1	1
Los Alamitos	0	0	1	0	0	0	0
Total in basin*:	41	54	77	66	79	83	97

*The basin total is the number of days when at least one monitoring station within the four counties reached the smog alert limit for ozone, which is .20 parts per million.
Source: South Coast Air Quality Management District

From the L.A. Times, November 1990

THREE INTERVENTIONS OF ETHERIC ENGINEERING IN SOUTHERN CALIFORNIA SMOG

- 1. 1987 -- PROJECT VICTOR 16.6% DROP
 - 2. 1989 -- PROJECTS BREAKTHRU & CHECKER 29.4% DROP
 - 3. 1990 -- CLINCHER 24% DROP
- AVERAGE DROP IN ALERT-DAYS, 3 SMOG SEASONS: 23.4%

TJ/ATMOS ENGINEERING PTE LTD, Singapore

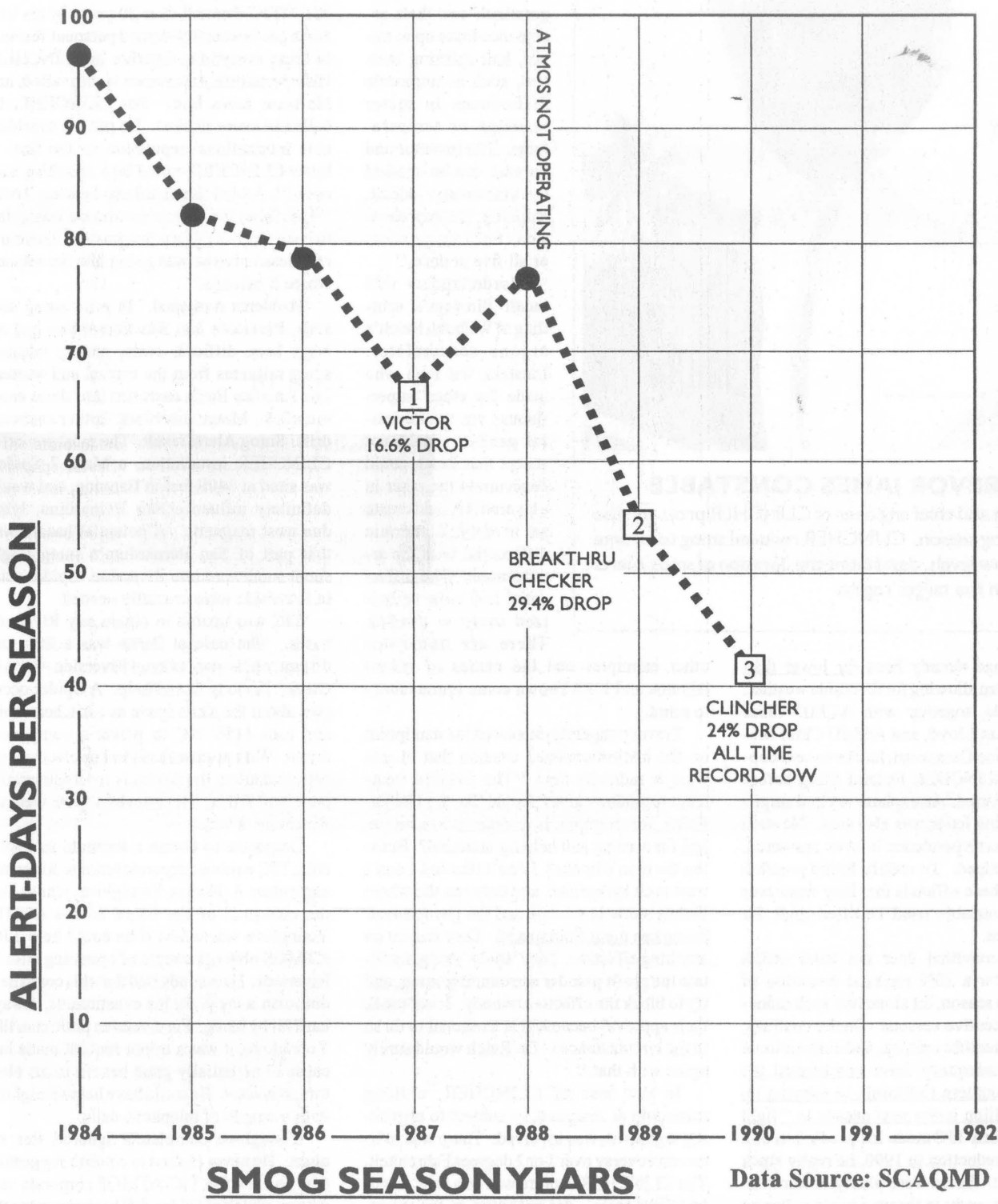



TREVOR JAMES CONSTABLE

Architect and chief engineer of CLINCHER project in the 1990 smog season. CLINCHER reduced smog to all time record low levels, devastating the duration of smog Alerts by 60% in the target region.

that smog had already been far lower than expected, even allowing for favorable weather.

Dr. Lents, together with AQMD Chief Scientist Alan Lloyd, and AQMD Chief Meteorologist Joe Cassmassi, had been sent copies of the CLINCHER Federal filing before the season started. An explanatory and amplifying covering letter was also sent. No such corporate correspondence is ever answered, or acknowledged. To nullify future possible denials by these officials that they were ever advised, Constable used certified mail for these advices.

The wherewithal does not exist within orthodoxy for a 20% regional reduction of smog in one season, let alone two such reductions in successive seasons. On the contrary, orthodox scientific opinion, and conventional technical inadequacy, have condemned the people of southern California to ponying up over \$20 billion in the next decade to "fight smog". When TJC made his prediction of a 20% smog reduction in 1990, he really stuck his neck out. There were plenty of know-it-alls who got ready to throw a horse collar on

other examples and the names of Albert Abrams and Ruth Drown come immediately to mind.

Trevor pungently expressed his standpoint on the institutionalized evasion that blocks what is radically new, "The nazified treatment orthodoxy gives people like the late Dr. Reich, for example, is a disgrace to science. Jail for serving and helping mankind? Burning the man's books? I don't like and I don't trust such barbarians, and they run the whole bloody show in science and the government. Smog has them flummoxed. They cannot do anything effective. They 'study' smog, facilitate the profit plunder surrounding smog, and try to block the effective remedy. I don't seek their approval because it is irrational to do so in the circumstances. Dr. Reich would surely agree with that."

In the case of CLINCHER, nothing miniscule or marginal, or subject to nitpicking argument, was involved. There was to be no controversy over 1 or 2 degrees Fahrenheit. The CLINCHER venture was on a vast, mind-boggling scale. Air pollution in the worst-

his neck.

Says Constable, "History confirms unerringly that orthodoxy's reaction to truly radical developments, is to bash them into the ground. This is usually achieved when such advances are germinal, and their acceptance turns upon minor, hair-splitting matters, such as minuscule differences in meter readings or temperatures. The inventor and the idea can be crushed by dishonesty, deceit, stupidity, incomprehension, neurotic evasion, or all five at once."

Borderlanders will recall Einstein's scuttling of Wilhelm Reich's orgone accumulator. Einstein, the man who made the ether 'superfluous' via mathematical gambits, could not accept that Reich could concentrate the ether in a layered box, and create an irrefutable thermic differential with the arrangement. The differential had to be verbalized away -- evaded.

There are numerous

afflicted region in America, four huge counties in extent, was to come down seasonally by one fifth. Could such a colossal reduction actually be achieved two years in a row? All this by "etheric engineering" when orthodoxy remains compulsively convinced that there is no ether? Could it be done?

The men in TJC's ATMOS group were in no doubt. According to veteran aide Irv Trent, 75: "TJC devoted over 20 years of his life, and a professionally-earned personal fortune, to bring everything together in CLINCHER. His operational experience is unrivalled, and his team loves him. For CLINCHER, he called in every marker. He put his considerable international reputation on the line. I knew CLINCHER would be a smashing success." Added the scholarly-looking Trent, "This time, the etheric revolution was going to bash orthodoxy into the ground. Einstein's etherless universe was going into the ashcan, where it belongs."

Problems remained. In prior smog seasons, Riverside and San Bernardino had always been difficult areas, mainly because smog migrates from the central and western Los Angeles Basin eastward into these communities. Mountains block further eastward drift. Smog Alerts result. The most powerful CLINCHER installation, a Mark 7 Spider, was sited at 3400 feet in Banning, and would definitely influence San Bernardino, lying due west magnetic. A potential hazard was that part of San Bernardino's smog might shunt southward into Riverside. Spider units in Riverside were crucially needed.

TJC was unable to obtain any Riverside bases. The base at Perris was a little too distant, on its own, to keep Riverside Alerts in check. Nobody would help. A Spider occupies about the same space as a kitchen chair, and uses 115V AC to power a component motor. With no chemicals and no electromagnetic radiation, the device is environmentally pure, and silent. Nevertheless there were no Riverside takers.

Desperate to obtain a foothold in Riverside, TJC wrote a corporate letter to Riverside supervisor A. Norton Younglove, who is also the chairman of the board of the AQMD. Younglove was asked if he could help TJC/ATMOS obtain a couple of operating sites in Riverside. He was advised that this could help diminish a curse on his constituents, always hard hit by smog. For a veteran politician like Younglove, it was a minor request made in a cause of potentially great benefit to his electors, at no cost. He could have helped mightily with a couple of telephone calls.

Younglove completely ignored this request. He never replied to a polite suggestion that he view the TJC/ATMOS corporate videotape, which provided full background to the



SETTING UP FOR CLINCHER

TJC adjusts a Mark 5 Spider etheric vortex generator in Reseda -- a 1989 smog trouble spot. Reseda had zero smog Alerts in the 1990 season under the CLINCHER program mounted by TJC with Singapore financing. "Appallingly simple," is how Constable describes the device, adding that it is also "an appalling embarrassment to orthodoxy that they did not uncover these principles decades ago, and must now seek to suppress them from public benefit." These units use no chemicals and emit no electromagnetic radiation.

LOS ANGELES TIMES

FRIDAY, DECEMBER 14, 1990 A61

1,310,822 PEOPLE HELPED WRITE THIS ARTICLE.

CORPORATE DAMAGE CONTROL?

This advertisement from the December 30, 1990 Los Angeles Times presents the far-fetched idea that fueling up on ARCO gasoline made the air in Los Angeles cleaner during the 1990 smog season. Was it 1,310,822 ARCO customers burning gasoline in autos, or a small group of dedicated individuals using advanced etheric technology, that helped clean the air? Confidential sources have intimated that ARCO's upper level management was aware of CLINCHER while in progress. ARCO will continue to sell gas in 1991. TJC/ATMOS will be non-operational in the LA basin during the 1991 smog season.

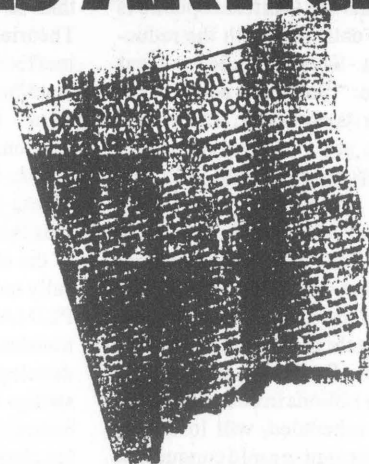

ARCO customers, driving with our Emission Control Gasolines, have helped to make 1990 the cleanest year for air quality in forty years. In fact, they've eliminated over 90 million pounds of air pollution in just over a year's time. But they're not alone. People are using public transportation. People are carpooling. Businesses are doing

their share. We're all doing something to reduce smog in the Los Angeles Basin. And it's paying off -- for everybody. The South Coast Air Quality Management District reported a dramatic drop this year in expected smog levels. It's a sure sign that we can all make an impact. Let's keep it up. Let's keep cleaning the air.

ARCO 
SEARCHING FOR CLEAN AIR SOLUTIONS
© Copyright 1990 Los Angeles Times. All rights reserved.

SINGAPORE "ANGEL"

George K. C. Wu is the Singapore self-made multimillionaire entrepreneur who financed CLINCHER. His gift to southern California was the cleanest air since the smog records started - something no U.S. financial source would touch. Busy now marketing the technology with Asian governments, Mr. Wu emphasizes that he already has all the money he will ever need. "Mankind has a much greater need," he says, "and it is for these new ways that CLINCHER demonstrated so clearly for southern California."

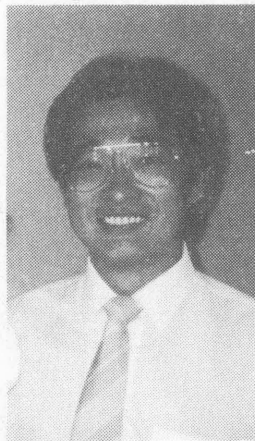

CLINCHER operation. Younglove was not alone. The California State Air Resources Board declined a request to give TJC a 10-minute hearing at one of their meetings, to explain personally to them the nature of the unorthodox TJC/ATMOS approach. This offer was made by the president of a private corporation that had invested more than half a million dollars in original weather modification research, now sharply germane to California's major pollution problem. That same man, Trevor James Constable, through his widely translated aviation histories and biographies, enjoys an international literary standing and respect for his integrity. TJC/ATMOS corporate videotapes sent to the ARB and to its scientific division evoked no response, not even acknowledgment of receipt.

These attitudes and reactions on the part of officialdom show that the California public is ill-served by those entrusted with the reduction of air pollution. Says TJC aide Irv Trent of this phenomenon: "Smog has actually become an industry in its own right. The truth is that nobody in the seats of power wants it sliced down in 25% chunks in the way that TJC demonstrably can do it, right now. He could cut it 50% more with new findings from CLINCHER, and 40-60 little vortex generators." Isn't this what California needs? The crusty veteran Trent sees it otherwise. "Smog vanishing on that scale is the derailment of a gigantic gravy train. Businessmen programing profits from the billions in coerced capital investment that is scheduled, will lose their shirts. Politicians recognize rapid conquest of smog as the end of smog graft. Bureaucrats see massive smog reduction as termination of their smog empire building. The public doesn't have a chance against this crooked combination, with its criminal selfishness and vested interest in smog."

The unfoldment of CLINCHER began with six "Spiders" -- basic generators of etheric vortices. The principle is direct, and is based

upon the existence and technical accessibility of the ether. That element of the ether with which Constable deals, he describes as "a physical natural force of extreme subtlety but tremendous power, that is geometrically accessible." Constable is aware that this is indigestible by the established order in physics. "The directly visible control of local weather on the high seas, that I have repeatedly demonstrated publicly on time lapse video tape -- at horizon distance -- is something not feasible by any other method," he says. "Victims of parrot education squawk that there is 'no ether, no ether, no ether!' I have proved via real-world results rather than talk and theory, that the ether is an objective reality that is technologically usable. Theories are cheap. Theories are ineffective against smog, and mankind suffocates. Only results count. I get results."

Constable's basic approach is that the ether underlies the atmosphere in all its workings. He sees the atmosphere as the slave of the ether. Vortices geometrically induced in the ether -- at the PRIMARY or etheric level -- will translate into the atmosphere, and develop into vortex chains or strings from the original disturbance. The largest of these vortex chains are sometimes seen on official surface analysis weather maps as low pressure systems in strings two, three and sometimes four in a row. Constable says that during May and June of 1990, such strange strings of lows extended in straight lines from southern California all the way to northern B.C. and southern

Alaska, "carried on and in the south-to-north summer flow of etheric force."

Thousands of lesser and miniature implosive vortices result locally as well, initiated by and migrating from each Spider unit in accordance with seasonal, lunar and diurnal etheric flow laws. "These vortices spread out in the vast rivers of etheric force that flow through the physical world unperceived and unsuspected by most humans." These vortices probably entrain subtle particulate matter, driving it to the ground, via the points of the vortices, Constable says. This engineered implosive activity in the ether is his key to countering smog, by dynamizing torpid atmosphere over hundreds of square miles.

Los Angeles Basin topography provides natural circumstances for smog build up, through physical confinement and inadequate atmospheric movement. Orthodoxy accepts that. The deceptively simple Spiders act against atmospheric stasis, and help re-establish etheric balance. The Spiders work exclusively on the etheric continuum, even though they are themselves physical assemblages. The implosive vortical activity initiated by the Spiders also strongly inhibits ozone. Spi-

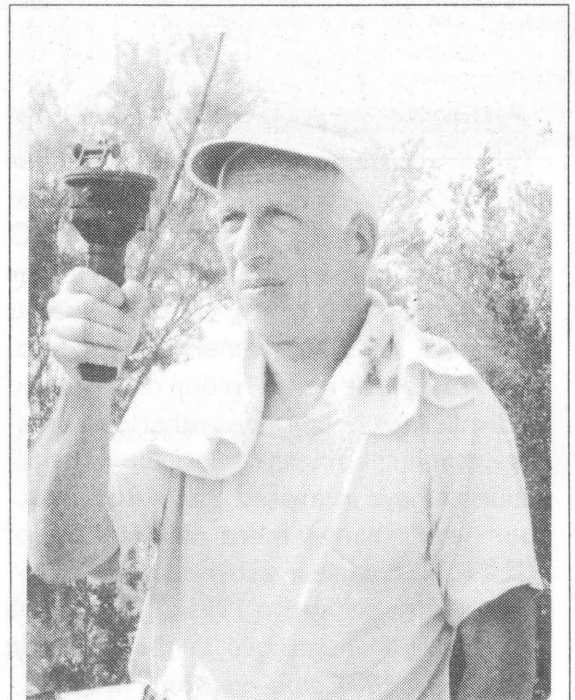

CRUSTY VETERAN AIDE

Irwin Trent, 75, is the oldest associate of TJC and has seen the entire unfoldment of weather engineering in southern California during the past 20 years. He calls smog "an industry in its own right, and a source of terrible political corruption."

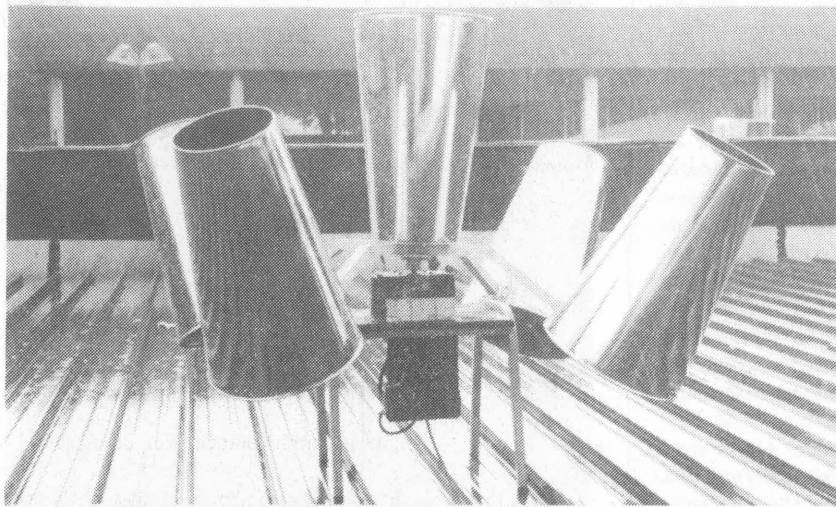

RAIN SPIDER

A "Rain Spider" brings rain down in Singapore during 1990 tests. Similar units produced the triumph of CLINCHER in the 1990 Smog Season.

ETHERIC VORTICES IN ACTION

The U.S. Navy Western Oceanography Center at Pearl Harbor, Hawaii, originated this radiofacsimile surface analysis weather map. The Valid Time is midnight, Greenwich time, 10 May 1990. After start-up of Operation Clincher in Los Angeles on 1 May 1990, TJC noted that a string of low pressure barometric systems formed (Margin designation A,B,C,D) from southern California (A) to Alaska (D). Similar atmospheric vortices continued to appear in strings for the next two months in this anomalous fashion. TJC interprets their appearance, and persistence, as due to vortical activity induced by CLINCHER apparatus operating 24 hours a day in Los Angeles. Such vortical activity in the main south-north flow of etheric force in spring and summer (northern hemisphere) behaves similarly to vortices in other media. Etheric vortices translate into the atmosphere eventually, as indicated here by this 2500 mile-long vortex string. Inducing such impressive vortices locally is the key to mastering smog, according to TJC. The real-world consequence of the persistently appearing vortex strings above, was the wettest northern California spring in 60 years, and obliteration of drought in the Pacific northwest. Also obliterated were doomsday, computer-born predictions of drought disaster in the Pacific northwest. The on-site rain gauge at BSRF headquarters in coastal northern California measured 19" in May and early June 1990, during predictions of drought and an early fire season.

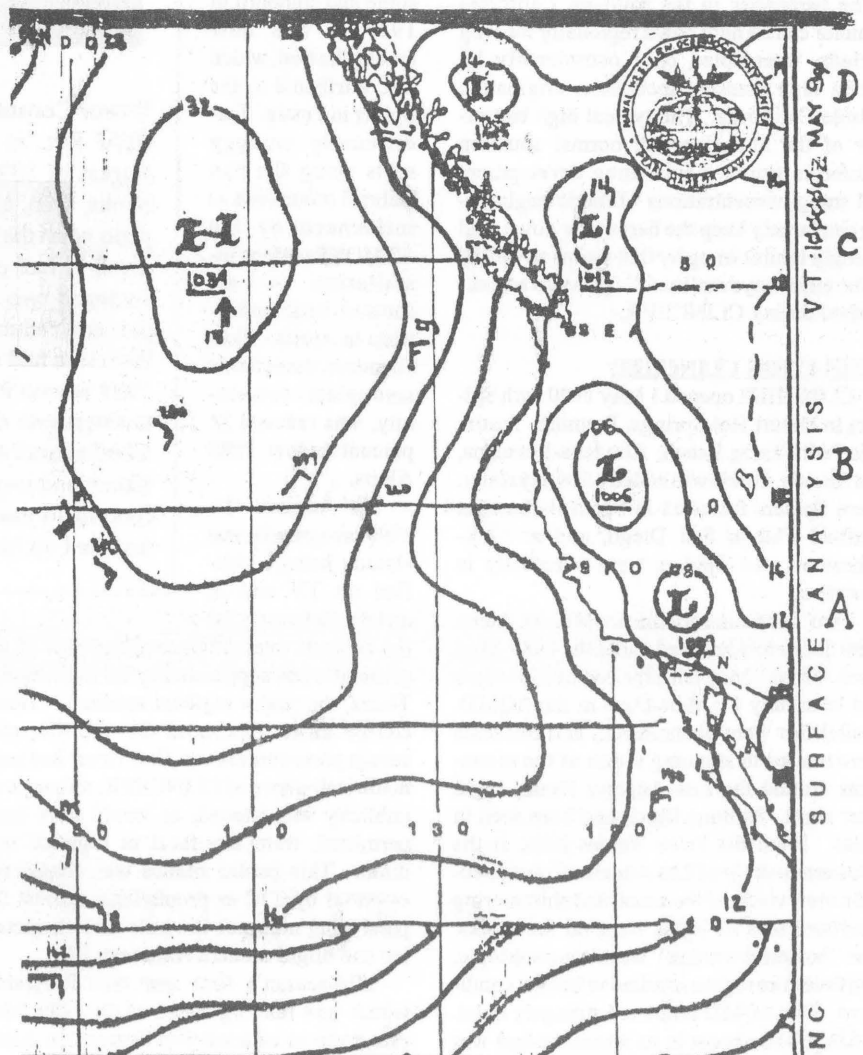

ders furthermore, help disperse the notorious inversion layer over the Los Angeles Basin, the "lid" that holds smog against the earth, confined by the surrounding mountains.

This unique topographic situation causes the smog build-up for which Los Angeles is justly infamous, with the sun adding photochemical reactions to the lethal brew. Windy, vibrant days are common in southern California when Spiders are in function. Someday soon, Constable says, it will be possible to eliminate the inversion layer over Los Angeles, through etheric engineering, and return the region to clean, primal conditions. Today's Spiders give the inversion layer a hard time, constantly tending to disperse all stasis.

"The extensive implosive activity initiated and sustained by a collection of Spiders, tends also to reduce barometric pressure by increasing the etheric potential near the surface of the earth," according to Constable. "The barometer in the southern California summer can be held down regionally for long periods, interrupted only occasionally by strong high pressure incursions originating outside California. The typical high barometer of the unengineered, normal southern California summer aids smog development and smog concentrations. Etheric engineering can largely keep the barometer down, and strongly inhibit smog by this means as well as in the other ways outlined." This was accomplished during CLINCHER.

OPERATION CLINCHER

CLINCHER opened 1 May 1990 with Spiders in Desert Hot Springs, Banning, Tustin, San Pedro-Long Beach, Altadena-Pasadena, and Reseda. Perris was added a few days later. More Spiders followed in Santa Barbara, at Hatfield Flat in San Diego, and at LAX-Crenshaw. 14 Spiders were eventually in operation.

Two fabulous months ensued, as Alerts were decisively reduced under the 1989 Alert level. From 1 May until the end of June there had been only 11 Alert-Days in the AQMD. Visibilities were phenomenal, and residents were treated to stunning views of the mountains around the Los Angeles Basin, night after night. Nothing like it had been seen in years. From the Palos Verdes hills, at the southernmost tip of Los Angeles County, 40-mile view vistas of the coast, and shimmering landward seas of lights went on for weeks. The "beautiful weather" was a common topic, and the entire region revelled in benign conditions. The AQMD remained strangely quiet. A \$20 million boost in its annual budget was imminent, as the region sailed on in the cleanest air on record. The AQMD annual budget is now \$100 million.

As the season reached the end of July, the effects of the TJC/ATMOS installations were significant in the mid-year statistics. The unit in Altadena-Pasadena exerted wide influence beyond Pasadena itself, which was reduced at least 50% in Alerts from 1989. The Reseda installation resulted in zero Alerts for the entire season -- a shutout. San Bernardino Alerts were dramatically reduced, and the Orange County area -- troublesome and stubborn in 1989 -- was now among the best, which TJC attributed to the Spider in Tustin. Traditionally smoggy spots along the San Gabriel mountains -- influenced by the ATMOS Pasadena installation -- all showed large reductions in Alerts. Even Glendora, the nation's smoggiest community, was reduced 24 percent below 1989 Alerts.

By August, the 1990 smog season was already being identified on TV and in many newspapers, as the cleanest ever. This startling fact of regional life was suppressed by the Los Angeles Times, the major regional medium. Times editors killed reports of the AQMD mid-season press conference. The Times had been made well aware of CLINCHER, although no publicity was wanted, or would have been permitted, from any local or regional medium. This public silence was considered essential by TJC as prophylaxis against the paralyzing nuisance lawsuits that characterize and blight modern American life.

Mid-season's *bete noir* was Riverside, which was running ahead of its 1989 Alert rate, even as adjacent San Bernardino Alerts had been reduced more than 60%. This was serious. Some of San Bernardino's smog was being shunted into Riverside, where no Spider



ALLIED FORCES

Trevor Constable (left) with the late General Curtis LeMay USAF Ret., at the general's Riverside, California home in August of 1990. A longtime fan of Constable's aviation books, Gen. LeMay provided a "Spider" site on his own patio when the Riverside smog alert rate rose alarmingly in the first half of the 1990 smog season. General LeMay arranged two additional Riverside sites as well, and a 50 percent reduction in the Alert rate in Riverside ensued. Riverside had smog Alerts reduced 11 percent under the 1989 season for an all-time low. Riverside politicians and businessmen declined to assist CLINCHER. The former Chief of Staff of the USAF and creator of the Strategic Air Command stepped into the breach. He enjoyed seeing the mountains east of his home every day after the Spider was installed on his patio, previously a rare happening.

sites had been obtainable, and where local Supervisor Younglove had declined assistance.

An internationally famous gentleman now made a decisive entry into the CLINCHER drama. TJC was taken to Riverside to finally meet General Curtis E. LeMay, USAF Retired, former Chief of Staff of the USAF, creator of the Strategic Air Command and a longtime fan of TJC's aviation histories. General LeMay had kindly provided, just a few months previously, a jacket blurb to TJC's latest biography, *FIGHTER GENERAL, The Life of Adolf Galland*, published in June 1990. In addition to General Galland, TJC and General LeMay have numerous mutual friends among aviation luminaries. In 1968, TJC had worked for the Wallace-LeMay presidential

campaign, a seemingly vain labor that was about to come full circle.

Immediate accords developed between TJC and General and Mrs. LeMay. A notorious tinkerer and "can do" guy, LeMay immediately wanted to view the ATMOS videotape. When he met TJC on 11 August, after viewing the videotape several times, he had his right forefinger raised admonishingly, his pipe in the other hand. "You never convinced me one bit with that videotape. Not one bit. BUT I WANT ONE OF THOSE DAMNED THINGS IN MY BACKYARD."

TJC had one of his Spider units in his car, in anticipation of getting the General's help. He pulled it out and the former Chief of Staff of the USAF helped him install it. Two additional Riverside bases were promptly provided by LeMay aides, downtown and at Norco, and a dramatic turnaround resulted in Riverside smog.

In the 1 May to 11 August period, Riverside experienced 1 Smog Alert for each 9 days. After the intervention of General LeMay, from 11 August through 31 October, Riverside experienced 1 Smog Alert for each 20 days. That brought Riverside in with 15 Alerts for the 1990 season, against 17 in 1989, an 11.7% reduction. Without General LeMay, Riverside would have been a nasty blot on CLINCHER'S statistical triumph, and the promised 20% reduction of Alert-Days would probably have become marginal.

The time nexus of General LeMay's involvement also demonstrated objectively what Spiders could do in a heavily smogged area, producing more than 50% reduction in Alerts after installation. Says TJC of General LeMay: "His last involvement on this earth was to directly benefit every one of his fellow citizens in Riverside, right down to babies. He performed a wonderful, life-giving deed. He was vital to our victory. General LeMay is the hero of CLINCHER, and a hero to me and my men. I took his passing deeply to heart."

General LeMay at 83, was full of ideas and plans to use Spiders for clearing fog at USAF bases afflicted with this problem. He had seen the smog-veiled mountains east of his home come into view after the Spider was installed in his patio, and stay visible. He was proceeding to get USAF interest when he died suddenly at the beginning of October 1990, a shattering loss to the USA and to the ATMOS group.

When taking what was to be his final leave of TJC, his words were typical LeMay, and also prophetic. "It doesn't matter if we don't know ALL about this ether thing right now. We'll find that out. You're doing what has to be done. Just go right at them and let 'em have it." This legendary commander served as an

inspiration to TJC's team. In seeking to serve mankind through the years, they had found almost every man's hand turned against them. General LeMay gave them a hand, a morale boost and vital assistance.

Says TJC: "Curtis LeMay is one of the few men I have known in my lifetime who knew how to listen. He contained his own reactions completely, which few men can do, while you were speaking. He was totally locked on to you. When you were through, he had a basic comprehension of what you had said, no matter how novel, or off-the-track. That's rare in this world."

By the end of the smog season, on 31 October 1990, CLINCHER was operating from fourteen bases and had made history. Southern California had experienced its all-time

"Victims of parrot education squawk that there is 'no ether, no ether, no ether!' I have proved via real-world results, rather than talk and theory, that the ether is an objective reality that is technologically usable. Theories are cheap. Theories are ineffective against smog, and mankind suffocates. Only results count. I get results."

Trevor James Constable

record low smog season, exactly as laid out in the Federal filing made by Constable back in April. The L.A. Times ran a story covering the smog season, with a statistical tabulation that is reproduced with this article. Participation by TJC/ATMOS with CLINCHER was unmentioned in the Times and ignored by the smog bureaucracy, which had been kept apprised of all CLINCHER developments since early April. The only mention in print came from the "alternative" press, this Journal and Antony Sutton's Future Technology Intelligence Report.

ONLY RESULTS COUNT

"ONLY RESULTS COUNT" is Constable's motto. Here are the major results of Operation CLINCHER:

1. REDUCTION in seasonal Alert-Days by 24% below 1989. This reduction was 4% more than the CLINCHER target announced by TJC in April 1990. The Alert-Day is essentially a statistical device for assessing seasonal smog levels, and is not an objective

quantification.

2. REDUCTION IN DURATION of 1st Stage Alerts by 60% under 1989. 1990 Alerts recorded lower levels of ozone and the Alerts lasted less than half as long as in 1989. This achievement was a public service of the highest order.

3. ACTUAL REDUCTION in the NUMBER of Alerts from 1989 was staggering. In the various individual smog monitoring areas of southern California, the drop in Alerts was far more spectacular than the reduction of abstract Alert-Days, used for assessing the entire region.

ACTUAL ALERT REDUCTIONS were, typically:

San Bernardino	DOWN 68%
Pasadena	DOWN 58%
Norco	DOWN 100% ZERO ALERTS
Reseda	DOWN 100% ZERO ALERTS
Anaheim	DOWN 100% ZERO ALERTS
El Toro	DOWN 100% ZERO ALERTS
West L.A.	DOWN 100% ZERO ALERTS
Glendora	DOWN 24%
Azusa	DOWN 56%
Upland	DOWN 42%
Redlands	DOWN 41%
Riverside	DOWN 11%

The only blot on CLINCHER'S record was 2 Alerts in downtown L.A. against 1 Alert in 1989 -- a 100% rise.

4. HEALTH BENEFITS. Dr. Robert Phalen, who directs the Air Pollution Health Effects Laboratory at the University of California Irvine, opined in the L.A. Times that 1990's air quality improvements were significant enough to BENEFIT THE HEALTH OF EVERYONE LIVING IN THE LOS ANGELES BASIN. This universal benefit to southern Californians is of inestimable public value.

OVERVIEW

The all-around vast reductions in 1990 smog are unprecedented in the smog records. That these reductions were effected from the record low smog levels previously established during ATMOS operations in 1989, are convincing in themselves, and are doubly so in view of being predicted by the project engineer long before the season started.

Smog reductions of the 1990 magnitude and scope clearly infer MORE POWER being used in 1990. The inarguable results jibe with improved equipment and use of more than a dozen bases, against a past maximum of four. The result of the increased anti-smog power appears objectively as greater smog reductions for longer periods, with steeply lessened Alert times and peaks. There were dramatically lower levels of smog overall.

The impression of smog being technically mastered, by means of an effective modality

intelligently turned against its existence, is inescapable. There is nothing random about what happened during CLINCHER.

The direct connection between General LeMay's intervention and the subsequent halving of the Riverside smog Alert rate, strongly reinforces this assessment. The huge percentage drops in Alerts, and total suppression of Alerts, in districts where TJC/ATMOS equipment was located, as in Norco, Pasadena, Anaheim and Reseda, establish a further direct connection to CLINCHER operations.

Those still wishing to argue the existence of the ether -- to evade both the essential and the inevitable -- should look straight at the facts that glare out at them from the operational record of CLINCHER and its predecessors. Etheric engineering is here -- now. That is the clear lesson of CLINCHER. We ignore it to our own discredit and detriment.

The AQMD immediately claimed that "tougher regulations" had produced the near-incredible reductions in 1990 smog. Constable had expected the bureaucracy to make this assertion, which he classifies as preposterous. "The AQMD has no compunction about stuffing such rubbish down the public gullet," he says. "What they do not realize is that CLINCHER will not really be completed until 31 October 1991."

There will be no participation by the ATMOS group in 1991 smog in southern California. As in 1988, regional smog will be allowed to normalize, and Constable's prediction is that it will return to 1988 levels or worse. "We are running this little test in 1991," he says. "Tougher regulations vs. etheric engineering against smog."

By the time the 1991 smog season opens in May, Constable opines, the AQMD will have many more tough regulations in force. "They will therefore have no excuse for not improving on 1990. But mark my words: without our Spiders and expertise, heavy oppressive smog will return." He says that ATMOS must withdraw for statistical reasons, and a line on a piece of paper -- "the graph of the seasonal Alert-Days rising steeply from the all-time low produced by CLINCHER."

CLINCHER has described new modes of action using etheric technology. The 1991 southern California smog season will definitively establish the efficacy of tougher, more extensive regulations.

POSTSCRIPT

Immediately after the end of CLINCHER, TJC transferred a car from Hawaii to California registry. He was charged a cash smog penalty of \$300 for the transfer. "It's your share of what it costs to fight smog," he was told by the Department of Motor Vehicles bureaucrat.

Gasp of hope for Mexico City air

By KATHERINE ELLISON
Knight-Ridder Newspapers

MEXICO CITY — Here's the latest notion to fight this city's smog, widely known as the world's worst: oxygen booths for quick hits of an increasingly elusive commodity.

"We need hundreds, even thousands of them," said the project's promoter, Alfonso Cipres Villar-

For about \$1.70
a hit, suffering
passers-by ...
can revive
themselves.

real, president of the Mexican Ecologist Movement.

On March 21, Cipres plans to install 10 such booths in the capital's noxious downtown. At that time, for about \$1.70 a hit, suffering passers-by supposedly can revive themselves, in approximately 90 seconds.

Winter always aggravates the capital's pollution, because cooler temperatures trap ozone, carbon monoxide, lead and other contaminants in the valley area, in so-called "thermal inversions." But this year, the smog season began much earlier than usual and seems much worse.

Hardly a day has gone by since November without at least one alarming newspaper report on the effects of what is known here as "la

SOLUTIONS?

In 1987 Operation VICTOR, engineered by TJC/ATMOS, reduced the LA smog to such low levels that a worldwide group of scientists who converged on LA couldn't find enough smog to study! For less than the cost of one oxygen machine the LA smog was reduced. Governments and industries now have the opportunity to use this beneficial technology.

contaminacion." Last month one said 75 percent of residents suffer neurosis and memory loss from pollution and other city stresses. Another reported that dead birds were falling from the sky — a familiar smog-season story, yet this time with the frightening headline "Humans Next."

"Smog makes us crazy — it's the culture of smog," said poet Homero Aridjis, head of the Group of 100, made up of environmentalist artists and intellectuals.

Part of that culture is a growing demand for relief, such as that promised in Cipres' oxygen-booth plan. After seeing the booths in hospitals in Paris and Los Angeles, he said, he organized the Mexico City trial run, with an investment from a Jewish community center in Los Angeles with which he has connections.

Each booth, made by the Denver company Mountain Medical Equipment Inc. for sufferers of respiratory ailments, costs \$5,900, Cipres said. But he believes they will pay for themselves.

Still, the plan has foes, among them poet Aridjis, who points out that normally oxygen supplements require a doctor's prescription. Critics also call the scheme merely another in a series that evades the real issue of fighting pollution at its source.

Source:

Santa Rosa Press Democrat,
February 19, 1991

SACRAMENTAL THINKING

further considerations on anti-gravity or ethereal forces and related matters

Joel A. Wendt

A few words might be in order concerning what was written in my previous article.

The 'work in progress' of which the Journal is becoming an organ of self awareness, and which investigates ethereal, orgonic, and radionic phenomena appears to be an embryonic manifestation of the latent faculty of the American Soul for experimental work leading to what Rudolf Steiner called "mechanical occultism," or the invention of devices which can be set in motion merely through a particular gesture.

There seems to be some relation between these forces, the act of thinking and our moral nature.

Given the tendencies and temptations (e.g. spiritual materialism and atavism) which the soul of modern man must face as proper rites of passage leading to new knowledge, how may a true understanding of these forces be gained?

In the way the human being is organized, as a physical and spiritual organism, his experience of the world is of such a nature that his consciousness divides up what in reality is a unity. Man experiences as separate his sense impressions and his thoughts about these impressions. To our consciousness the 'thing' and its 'idea' are two different experiences.

Rudolf Steiner has taught that this is not so, that the world is not itself 'split' in this way, and that the task for modern humanity is to overcome this 'onlooker separation' and reunite what first comes to us as divided. Further, he explains, that there is a purpose to this separation. Mankind having previously been in the 'bosom' of the Gods could only come to true freedom, real moral freedom, after having lost its connection to the fundamental spiritual reality. The direct experience of the unity of the world, previously a gift to man, had to be lost so that whatever relationship man was to have to the spiritual would be the result of man's own yearnings, desires and efforts.

Toward this end Steiner wrote The Philosophy of Freedom, which involves acquainting the individual with this split as it appears to his own consciousness, and leading those willing to that understanding which allows us freely to overcome our 'alienation' from the ground of the world. In this book Steiner

refers to the divided experience we have of the percept (the pure sense experience without any thought content added to it) and the concept (the 'ideal' entity which appears as a result of the activity of our thinking).

The understanding, which the study of Steiner's philosophic material can give of this problem and its resolution, cannot be covered here. Someone who wishes to appreciate this understanding in wholeness needs to take up an activity which might well involve years of effort (although this really depends somewhat on the moral forces that one brings to bear). Moreover, there are many students of Steiner whose work represents valuable aid. I recommend particularly Owen Barfield and Georg Kuhlwind. More especially I urge the study of projective geometry.

All these activities, study of Steiner, Barfield, Kuhlwind and projective geometry involve us in the activation of our own forces of thinking, the activation of our own ethereal forces. This 'practice' gives us a direct experience of something, and thus a knowledge of it which can be gained in no other way. Someone who, for example, is interested in the weather patterns of the Earth, and in particular wants to 'force' changes in these fundamentally musical, artistic and moral 'atmospheric' themes, might benefit from some direct knowledge in their own life of soul of the real consequences of mechanical, chemical and electrical assaults on this so subtle and beautiful countenance of Nature.

From a very practical viewpoint, the question can be put (in terms I hope will be useful to readers of the Journal): when I am experimenting, when I am in my laboratory (at my altar), how can I carry out my thinking activity so that it finds the true 'ideas' which go with the objects of my investigation? How may I unite the percept and the concept, which my given consciousness divides?

My own experience is that in this activity one is not acting alone. It makes a significant difference to the process of this thinking, that I engender a particular mood of soul, a mood acknowledging my limitations, and the need and desire I have for the appearance of Grace; that the will of the spiritual world would unite with my own will in the conduct of this activity. Rudolf Steiner, in his Knowledge of

Higher Worlds, describes the fundamental practical work as the practice of devotion. The anonymous author of the book Meditations on the Tarot: A Journey into Christian Hermeticism, refers to "learning to think on our knees."

Experience has also taught me that my ability to understand the riddles which I wish to investigate (in my case the riddles of human social and political life), involves a process of growth and development. In the beginning I am only capable of a certain limited understanding. There is no immediately going to the ultimate truth, rather one begins a journey in the course of which will be detours, set backs, high and low points, new insights, deeper understandings and so forth.

I support the pursuit of my goal by keeping in mind three factors. First, that what I know at present is a temporary approximation of the fundamental truth; and second, that at each time I begin to think anew on those matters of utmost interest I need to be willing to 'sacrifice' my previous understanding. The most grievous errors I can make are to believe I know the truth, and to hold on to what I know by becoming attached to it, by making my own identity and validity as a human being interdependent with these ideas. These errors then become a 'dam' to any further growth in the depth of understanding I may wish to acquire, because I already assume to know.

The third factor is the recognition that my moral intention will be determinative. The ability of 'Grace' to work with my thinking activity is dependent upon the moral 'atmosphere' of my soul life. For example, if I have become involved in some serious failure or responsibility in life, such that my own conscience is telling me that I should correct this rather than indulge my fascination with the 'riddle,' then this darkening of the soul life will interfere with my receptivity. Moreover, the selfishness or selflessness, which colors the pursuit of the 'riddle' also effects the degree of 'light' in my own soul, which then in turn serves as a barrier or a gateway to those 'Beings' who wish to cooperate with me.

Now one final hint. I have found as a practical matter that the Celebration of the Eucharist is the central archetype for the act of Sacramental Thinking. I leave it to the readers own resolute work, to his own free inner and outer deeds, to his discovery of the power of Imagination and Devotion when coupled with the soul faculty of Reason, to all the further adventures of one who wishes to find that 'thinking is the only way to travel,' that thinking 'can awake in its own primal element,' that thinking is of the light, is ethereal in nature and origin.

URANUS & THE RADIOACTIVE METALS

Alison Davidson

"Uranus represents the extension of perception into realms of superconscious mentality"

Stephen Arroyo

Within the vast span of the Milky Way galaxy our solar system exists as one point of stellar light among billions, one tiny cell in the greater galactic body. From Earth we watch the Sun and Moon rise and circle across the sky. We also see the inner planets navigate the dark oceans of night, the luminous points of Mercury, Venus, Mars and Jupiter sparkling with colour, inscribing spheres of energy unseen but powerful in their influence upon us. Fainter is the cold glow of Saturn and beyond this ancient guardian, in the far reaches of our system, lie the mysterious outer planets.

Referred to as the 'ambassadors of the galaxy' by the eminent astrologer Dane Rudhyar, Uranus, Neptune and Pluto symbolize forces which are not completely of the solar system but are within its sphere of influence "to link our small system (of which the Sun is the center and Saturn's orb the circumference) with the larger system, the galaxy."¹

Before the discovery of Uranus, Saturn marked the rigid barrier which the church had imposed on the universe for centuries. Only heretics dared to question the validity of this old system on pain of excommunication, or even death. So the advent of Uranus marked a revolutionary breakthrough in human consciousness, and the beginning of our liberation from the thralldom of an all powerful church.

Astrologically the outer planets symbolize cosmic, or galactic forces which penetrate the deepest levels of consciousness bringing about profound change and transformation. The energies of Uranus manifest in sudden, often disruptive changes producing the unconventional, often eccentric bohemian character who is impelled to break through old structures, inspiring the borderland scientist, the artist and musician, the occultist and inventor. In a more extreme way it also incites the anarchist and the violent revolutionary.

Like Prometheus who stole fire from the gods the Uranian native seeks to bring down the knowledge of higher worlds through radically new and original modes of self expression, hungry for excitement, freedom and experimentation, acting "as a channel through which powerful forces flow with electrical rapidity." This analogy is particularly appropriate because Uranus, which rules the zodiacal sign of Aquarius, has a strong kinship with electricity and the transference of information through sudden impulses and flashes of insight.

In the physical body Uranus is associated

with the electrical impulses of the nervous system. In the occult realm it represents the power of the universal mind, fuelling the "esoteric engineering" of the gnostic scientist, and is concerned with "the perfection of the electrical mindfield."²

The discovery of Uranus ushered in the age of global communications using electronic technology and synchronistically, with the unearthing of uranium, established the seeds of a far-reaching nuclear religion.

URANUS - THE COSMIC GIANT

It was an amateur astronomer and professional musician named William Herschel who, on March 13, 1781, discovered a new planet far beyond Saturn's orbit, a planet so distant from Earth it is almost invisible to the naked eye. He gave this faint sea-green tinted disc the unimaginative name Georgium Sidus after his patron King George III of England, but the name was soon changed by popular opinion to Uranus, father of Cronus (or Saturn) and the most ancient god of the heavens in Greek mythology.

For the ancient Greeks Uranus was both the son and father of Gaea, the Earth, who brought forth the first mythological race, the twelve Titans. He was the Sky, the Father Sky, and the father of the gods. But he feared his monstrous children and imprisoned them deep within the earth as soon as they were born. However, with the help of his mother Cronus attacked Uranus while he slept and with "the strongest metal", an unidentified substance called *adamant*, castrated him. After that he was of little interest to Gaea and soon faded from the mythological drama.

But back to the planet... It is possible that Herschel had only rediscovered a planet that had been mentioned in ancient Burmese writings, an invisible planet they called Rahu. After all, the Dogon tribe of Africa had described the four major moons of Jupiter, and the halo of Saturn's rings. Also, to the amazement of modern astronomers, they were not only aware of the recently detected white dwarf star which orbits the bright star Sirius, they also knew its orbit to be 50 years!³ So much ancient knowledge has been lost. So much remains for the Uranian explorer to rediscover.

Uranus is truly a giant, about four times the size of Earth and the third largest of the known planets. Its atmosphere is said by scientists to consist mainly of hydrogen and helium, its frigid body of methane and ammonia ices. But

it is a strange and eccentric giant, in true uranian style, and differs radically from the other outer planets in that its axis is tilted almost on the plane of its orbit. In other words, Uranus spins through space on its side leading scientists to speculate that it may have collided with another huge body in the far distant past, a catastrophic impact that thrust it into its present position.

If you could imagine standing at one of the poles of Uranus with its 84 year orbit, you would experience a 42 year-long day followed by 42 years of darkness. Another curious deviation from the other outer planets is that Uranus does not appear to emit more heat than it receives from the Sun.

The satellite system of Uranus also displays a turbulent history. Photographs returned from Voyager 2 revealed 10 new satellites as well as previously unseen details of the five satellites already known. They showed the evidence of a violent and complex evolution, from the bizarre topography of Miranda with its mosaic of intricate fractures, grooves and craters - looking as though it had been shattered to bits and then patched back together - to the long rift valleys and craters of Ariel, the pockmarked craters of dark Umbriel, and the lunar-like cratered surface of Titania. They are landscapes to thrill and awe the inhabitants of our seemingly placid planet Earth.

A system of rings has also been discovered around Uranus, a feature shared by Jupiter and Neptune as well as the famous rings of Saturn. There are at least eight of these narrow, widely spaced uranian rings, far thinner and more diffuse than those circling Saturn. The stones in these rings appear to consist of big coal-black boulders 'shepherded' by tiny orbiting satellites.

But even with the photographs and streams of electronic data gleaned from Uranus by scientists (and the crumbs of information they throw to the public), Uranus remains, as Bradford Smith, head of Voyager 2's imaging team puts it "... a planet of unfathomable mystery."⁴

THE 'URANIAN' METAL

While the seven planets of the ancients and their corresponding metals and spheres of activity have been well documented by occult tradition -- and more recently 'verified' by scientific experiments, especially through the research of Lilly Kolisko -- Uranus, Neptune and Pluto lie beyond this traditional body of knowledge. So here we take leave of tradition and branch out into a new exploration of the deep connections which undoubtedly exist between Uranus and the equally mysterious metal uranium; a substance that mirrors the transforming and radical nature of Uranus on earth, an incredibly powerful element which has altered the stream of human evolution with devastating effect.

Among ancient traditions the Native Ameri-

cans and the Aborigines of Australia were well aware of the existence and power of uranium, but there is no direct reference to this metal in alchemical literature although Czechoslovakia, which has large deposits of uranium ore, was a hotbed of alchemical experimentation in mediæval days.

The modern story of uranium begins in 1789, the year of the French Revolution, when a German chemist Martin H. Klaproth discovered a very heavy element and named it klaprothium. Shortly afterwards, he renamed it uranium in honor of the newly discovered planet.

Some 50 years later Eugene Peligot, a French chemist, isolated the first metallic uranium, but it remained practically ignored and was regarded as having few practical uses apart from the glass blowers of Bohemia and the porcelain makers of Saxony who used uranium oxide for the beautiful yellow and black colours it produced. The ancient Romans also used uranium oxide for colouring, discovered in a fresco near Naples with its striking colours still bright after 2000 years. Some uranium compounds are used in photography, but its real power of nuclear fission was only discovered a century later, a discovery intuited by Dmitry Mendeleev who working on his Periodic Table, was convinced that this new element with its great atomic weight (238.03) would be the source of major new discoveries.

It was a French physicist, Henry Becquerel who accidentally discovered the invisible emanations from uranium. During research into phosphorescence he left uranium salts on a photographic plate in a dark drawer waiting for a sunny day to continue his experiments. Later, when he decided to develop the plate he found to his amazement clear outlines of the uranium samples despite the lack of light. He concluded that uranium was "the first example of a metal revealing a property similar to invisible phosphorescence," or "stored-up light."

Dr Gustave Le Bon (a true Uranian character) took these experiments a step further and scandalized orthodox physicists by saying, and proving, that the radiations were not any form of light, but an absolutely new force. He also demonstrated that all matter emits radio-activity and the special properties of uranium were "only a particular case of a very general law."

When Becquerel announced the spontaneous fission of uranium, the scientific world pricked up its ears. Among those keen to explore this new element was the physicist Marie Curie who managed to obtain several tons of uranium waste and discovered other more highly radioactive elements including radium, giving great impetus to these researches.

Although in 1934 elementary uranium was considered to have no practical application, by 1939 there was a tremendous change in attitude when the explosive possibilities of nuclear reac-

tion came to the world's attention. In Italy, Enrico Fermi experimented with uranium by irradiating it with neutrons. Otto Hahn is generally credited with the discovery, in 1939, of the nuclear fission process, but according to other sources it was Marie Curie's daughter Irene Joliot-Curie, who, after repeating the experiments of Fermi, discovered that when a neutron hit a uranium nucleus it split it into two. She is also credited with establishing that in this splitting, several neutrons were released which, hitting neighbouring nuclei would cause further splitting so beginning a chain reaction.

A chain reaction only happens with human intervention, in naturally occurring uranium there are not enough U-235 atoms.

Soviet physicists, in one case experimenting deep underground in a Moscow Metro station where no cosmic rays could penetrate,

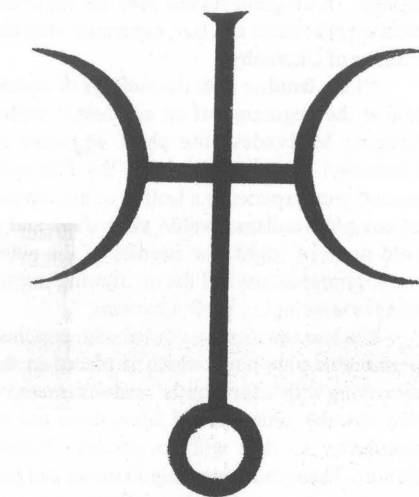

proved that uranium nuclei could disintegrate spontaneously.

When Fermi fled from Italy at the end of the 1930s Albert Einstein interceded with the U.S. Government to give financial backing to his uranium research -- an element he promoted as an important new source of energy, but more vitally from the government's point of view, could produce a powerful new weapon.

Millions of Chicago residents were unaware one day in 1942 that the most dangerous experiment in history took place in a city sports stadium -- under the bleachers at Stagg Field. This was the controlled chain reaction of splitting uranium nuclei. It is called 'controlled' when one neutron from each fission goes on to produce another fission. But when multiple fission happens, the reaction increases at catastrophic speed, within millionths of a second, creating an explosion.

Fortunately for Chicago, Fermi's calculations were correct: the chain reaction continued for 28 minutes and was then halted. If there had been even the slightest error the city would have

been devastated along with its inhabitants.

After his success, Fermi and other prominent scientists involved were taken to the uranium research centre in the desert at Los Alamos and their further experiments shrouded in secrecy. That is, until 1945 when the world witnessed the horror of a deadly new weapon unleashed upon Hiroshima and Nagasaki, claiming hundreds of thousands of lives.

Along with atomic weaponry came the 'peaceful' development of atomic power generation. By 1954 the first atomic power station began operating in the USSR. Then came the first atomic ice breaker called the Lenin, with a small lump of uranium replacing thousands of tons of oil or coal, and the Arktika, which after 3 years navigated its way through the ice sheet of the arctic ocean to reach the North Pole.

It is a curious fact that plutonium, a product of uranium, ultimately provided the electrical energy for the Voyager spacecraft to reach Uranus, its cosmic 'parent'.

THE METALLIC URANIUMS

Unlike the other metals described in these articles, I have never seen metallic uranium and probably never will. Its production and storage is surrounded by the highest security.

Described as a radioactive metallic element, uranium is silvery white in colour and moderately malleable and ductile. It is slightly paramagnetic but is a poor conductor of electricity. Almost as hard as steel and with a weight close to that of gold, uranium has the highest atomic number (92) of the elements found naturally on earth (which, according to nuclear physics, means there are 92 protons in the nucleus). Elements of a higher number such as neptunium (93), plutonium (94), americium (95) etc., are man-made. Scientists hypothesize that uranium is the product of the radioactive decay of other elements that once existed on earth, but are no longer found on this planet.

Uranium is never found naturally in its pure metallic state, but is extracted from the many types of uranium ores. Several hundred of these uranium containing minerals have been identified and the richest of these are uraninite UO_2 , the dark bluish-black mineral pitchblende U_3O_8 , which always contains helium, and carnotite. Ore deposits are never very concentrated, a typical ore contains less than 0.3% uraninite or pitchblende, so huge quantities of the ore have to be mined to produce very small, and very expensive, amounts of uranium.

Uranium has 16 isotopes and all but three are human-made. They decay to give off alpha particles to form isotopes of the element thorium. The decay of these isotopes finally ends in stable isotopes of lead. Isotopes are described as atoms of an element that have the same atomic number but different atomic weights.

The most common is called uranium-238

which makes up more than 99% of naturally occurring uranium. The next most common isotope is the rare U-235, which in the eyes of nuclear physicists is one of the most important substances in the world, for the simple reason that it is the only naturally occurring substance which fissions easily.

Another substance that fissions readily is plutonium-239, a substance produced by the neutron bombardment of U-238. This means that it splits into two smaller nuclei of approximately equal size, releasing large amounts of energy. [It is this unsymmetrical splitting of the uranium atom that researcher Carl Krafft uses as one point in evidence for the vortexian rather than the nuclear structure of the atom, although this subject is too complex to enter into here.]

Fission is brought about by bombarding the material to be fissioned with neutrons, so, for example, when the U-235 nucleus absorbs a bombarding neutron it may be split into a nucleus of Barium-141 and a nucleus of krypton-92, or iodine-137 and yttrium-97, or lanthanum-143 and bromine-90. Many other combinations are possible and these are called fission products. Fission is the reaction used in nuclear power stations to produce heat, to create steam to drive the turbines, and in atomic bombs to produce the explosion.

The third isotope U-234 occurs naturally only in trace amounts.

After grinding and other processes, the uranium ore is leached and through elaborate processes is converted to uranyl-nitrate from which uranium compounds or uranium metal may be obtained. Among the most common methods used to separate uranium isotopes for medical, industrial, military and industrial uses, are gaseous diffusion, centrifuges and laser techniques.

Uranium is very reactive, so easily oxidized that in powdered form it ignites spontaneously in air. It decomposes water, and combines directly with many gases. Although inert in alkaline solutions, it reacts with acids to form uranium compounds, which is why it is found more often in acidic rocks, such as granite, than basalt. It melts at 2070°F and boils at 6904°F, and chemically is related to chromium, molybdenum and tungsten.

Uranium is extremely toxic, both chemically and radiologically, which is why the disposal of uranium waste products is one of the gravest problems facing modern civilisation.

"Far out in the desert wasteland of eastern Washington, at the Atomic Energy Commission's gigantic Hanford plutonium works, radioactive elements surge in vast underground tanks - a pent-up sea of useless energy which is a constant worry to the scientists who unwillingly created it. This deadly broth of fission products is the garbage of the atomic age."

In 1979 there were 189 nuclear reactors in operation in the U.S. producing thousands of gallons of radioactive waste a day. And where does this waste go? The containers are dumped in the sea or buried underground, remaining to contaminate our planet for thousands of years. Some of the 'depleted' uranium is used for irradiating the food on our supermarket shelves. It's also been suggested by experts to send the containers into space, or even into the Sun!

A recent report stated that the bill for cleaning up defense related pollution at government sites in the U.S. alone could triple to \$12 billion a year by the year 2000.

NUCLEAR TEMPLES OF DEATH

Standing in gloomy isolation like the temples of some alien and sinister religion, the concrete domes and chimneys of nuclear reactors rise ominously from a once peaceful countryside. With good reason they are regarded with apprehension and fear, especially after the disaster of Chernobyl.

"I am familiar with the feelings of operators at the beginning of an accident," writes Gregori Medvedev, the chief engineer at Chernobyl in the 1970's. "In the first split second you experience a feeling of numbness, of complete collapse within your chest and a cold wave of fright...the needles of the automatic printer drums and the monitoring instruments are swinging in all directions."

Nuclear reactors are fuelled with enriched uranium or plutonium which is placed in the core along with 'control rods' made of a material that absorbs neutrons and takes them out of circulation so they will not produce further fission. These rods are manipulated so that just enough neutrons remain circulating to maintain a chain reaction with a multiplication factor of one. In case of emergency, the rods automatically move deeper into the core, absorbing more neutrons and (hopefully) instantly stopping the chain reaction. Power reactors in the U.S. use water as the moderator (it is the moderator which slows the neutrons down).

Apart from the power reactors are the much more dangerous 'breeder' reactors which convert U-238, which is not fissionable, into plutonium-239. In this ironically reproductive jargon, U-238 is called a 'fertile' material, in contrast to U-235 and Pu-239 which are 'fissile'. In a liquid metal fast breeder reactor it takes about 10 years for the reactor to have enough plutonium to refuel itself, plus fuel another reactor. The breeding must begin with U-235, and it must be a worry to the nuclear industry that if non-breeder reactors use up all the U-235 there will be none left to start the breeding cycle.

In certain breeders, no moderator is used because it is the fast neutrons that convert U-238 to plutonium. Water cannot be used to carry heat from the core as in a conventional reactor, be-

cause it would slow down the neutrons, so liquid sodium is used instead. Sodium is an efficient conductor of heat, but it burns on contact with air or water, becomes highly radioactive from the neutron bombardment, and being opaque, makes it impossible for technicians to see what they are doing when changing fuel or other core operations. Cooling becomes more difficult to control and accidents such as a meltdown become more likely than with conventional reactors. This ever-present danger is the price we pay for our power, every time we plug into the national electrical grid.

THE URANIUM LANDS

Although it is one of the most sought after substances on earth, uranium is not a rare mineral, in fact it is more abundant than such 'common' elements such as mercury or silver. But in most rocks the concentration of uranium is only a few parts in a million.

The leading ore reserves are found in the U.S., Canada, South Africa (where uranium is produced as a by-product of the gold industry), Czechoslovakia (the original source of the most of the world's uranium), Zaire (whose reserves are virtually exhausted), Australia and France. Details of the uranium reserves in other communist countries are more difficult to come by.

In the U.S. uranium is mined extensively in the south-western deserts of Utah, New Mexico, Arizona and Colorado, known as the Four Corners Area. This is land sacred to the Navajo and Hopi Indians who regard its centre at Black Mountain as one of the most sacred places in the world. Their tradition entails a limitless respect for the Great Spirit and for all living beings. Living in harmony with nature is of the deepest value and they direct their prayer ceremonies of song and dance for the balancing of nature in the world. However, these peaceful people have seen their ancestral land so devastated since uranium and coal mining began that they fear the destruction of their religion and even their own lives.

According to the Hopi Prophecy, inscribed on rock and passed down from generation to generation, the Great Spirit had warned that the resources lying dormant there were not to be taken from the ground until humans learned to use them for peaceful ends. Above all, they must never be used for war or destructive purposes.¹¹

Little did the Hopi and Navajo know that the uranium used in the atomic bombs dropped on Hiroshima and Nagasaki was mined on their land. But the Japanese were not the only victims. In the 1950's a total of 119 atmospheric nuclear tests were conducted in Nevada, blasts that lit the skies as far away as Los Angeles. Some 200-300,000 test subjects, U.S. soldiers, were experimentally dosed with radioactive fallout. We can only wonder how many of these 'atomic soldiers' are still alive today.

To carry out their claim for the coal and uranium on Indian land, the government declared it a 'national sacrifice' area and in 1974 the U.S. Congress passed a bill for the forced relocation, literally the cultural genocide, of the people who had lived there for thousands of years. The 'new lands' offered them in return are contaminated by the worst radiation accident in U.S. history, when in 1979, thousands of tons of radioactive water and sludge burst a levy and flooded into the Rio Puerco; this flows into the Colorado River, one of the major sources of water for southern California.

Many Navajos had no choice but to work for the multinational companies who did not inform them of the dangers involved in uranium mining. Those working in the mines suffered, and are still suffering, from cancer, severe radiation exposure and respiratory diseases. "I felt as if I had atomic bombs in my lungs," said one miner not long before he died.¹¹

The process of extracting uranium dioxide from the ore to produce 1 yellowcake generates large quantities of radioactive waste, as one ton of ore has to be processed to yield just 10 grams of uranium. An estimated 280 million tons of radioactive waste tailings have been left on Navajo land up to 1990. The driving desert winds scatter the powder over a vast area, contaminating the earth, the animals and the people. Many are becoming sick, stricken with cancer and other diseases, and even more ominously, a growing number of women are giving birth to deformed and mentally retarded babies.

But the mining continues. The government has declared this land to be 'eminent domain' and plans to have 1000 mines and 10 processing plants in operation by the year 2000.

THE GREEN ANTS DREAMING

The Aborigines of Australia have also been witnessing the destruction of their most sacred sites by uranium mining, and are speaking out about how the unique energy system that protects and energizes our planet is being destroyed.

They say that when their ancient ancestors came to Earth they created a circle of pyramids around the planet to protect it from a planetary disaster similar to that remembered in the ancient "Dream Time". They talk about cosmic rays which can only penetrate certain places on earth, cosmic energy which hits the uranium and vibrates out through the circle. If that is interrupted there will be no protection at all for earth.

The story of the Green Ants Dreaming tells of these green ants who live underground in the areas where the uranium belt is. They are considered cannibalistic and must never be disturbed. The Aborigines knew the poison, if allowed to seep up from the ground, would contaminate and kill the people.

But as Lorraine Mafi Williams, an Aboriginal spokeswoman, says, "now the mines have

started, they have left huge gaping holes in the ground where the fumes come up. The earth is dead around those mines, there's no life, nothing. When the cosmic beams come at certain times there is no uranium left to receive it."¹²

For people so finely attuned to nature, it is obvious why the uranium must remain in the ground. It performs a vital function in the organism of our planet, and when it is disturbed it becomes a deadly poison. As the Hopi say "...the land is like part of our own body. It is our mother. The energy resources here belong to the earth, they are mother earth's organs. It is necessary for the earth to keep its organs healthy."¹¹

This understanding is also expressed in another way by the scientist and philosopher Dr Walter Russell in his book *Atomic Suicide*: "These so-called deadly radioactive poisons are preparing the soil for oxygen dependent life to live by causing countless billions of microscopic explosions in the rock formations underground to release water and other necessities for human life and vegetation...It is only when we dig them out from under the ground and condense tons of harmless rock to ounces of deadly free metal, such as uranium piles, that we make the earth uninhabitable."⁸

THE INVISIBLE KILLER

"Education about the biological effects of nuclear radiation is an absolute prerequisite if the human race is to survive." Walter Russell

What is radioactivity, this silent and invisible killer? It is not the unique property of uranium as generally assumed. Late last century Le Bon demonstrated that "[t]he spontaneous radio-activity of certain substances, such as uranium and thorium...is in reality a universal phenomenon and a fundamental property of matter." All matter is radio-active, all matter emits invisible particles which travel at immense speed, such as alpha, beta and gamma rays, and all matter is in the process of dissociation, becoming transformed into other elements which finally lose their material qualities and return to the 'imponderable ether' as energy.⁶

As another noted researcher Dr T. Henry Moray put it, "through the evolution of matter and the evolution of forces, matter is continuously changing into energy and energy continually changing into matter."¹³ They are, as the ancient alchemists asserted, two forms of one and the same thing.

The particles emitted through radio-active decay describe various stages of the dissociation of matter which becomes more and more subtle as it returns to pure energy. The radio-active process produces an 'emanation' according to Le Bon which is "an intermediary between the material and the immaterial... between matter and the ether." This emanation gives birth to alpha rays, positive ions moving at amazing

speed which make the air a conductor of electricity; then beta rays described as negative electrons with a greater power of penetration enabling them to produce photographic impressions; and gamma rays with even a greater power of penetration, said to be similar to X rays, "and which seem to constitute one of the last phases of the dissociation of matter before its final return to the ether."⁶

Normally the destruction of matter happens so slowly that it is imperceptible to us, but in substances called radioactive, and artificially produced, such as uranium or plutonium, the dissociation is spontaneous and extremely rapid.

As Russell describes it: "Every thing in Nature dies normally by slowly radiating its heat." But, "[r]adioactivity is the explosively quick death principle... Atomic fission helps matter to explode instantly instead of decaying over long periods."⁸

This is consistent with the astrological view of Uranian energies, which are observed to always accelerate the rhythm of nature.

NIGHT OF THE LIVING DEAD

The highly radioactive metals are dead and decaying bodies that poison and contaminate everything they come into contact with, an unconscious perception perhaps, that inspired such gruesome cult horror movies as *The Night of the Living Dead*. Like corpses these substances belong under the ground, because when they are taken from their natural place and let loose into the world there is no end to the nightmare.

This has been made tragically clear to many people in the world including the people of Palau, whose islands in the Pacific reek of poisonous radioactivity due to early U.S. testing even though the entire topsoil was removed; especially the women who after nine months of anxious pregnancy have given birth to what they call 'moles' because these lumps of undifferentiated tissue resemble nothing remotely human, because the land, the water and vegetation are so contaminated. Or certain Aboriginal tribal people who, after the British had carried out their atomic testing in the outback deserts of Australia, gave them rubber boots to wear to protect them from their poisoned ancestral lands.

The cells of the reproductive organs are particularly vulnerable to radioactive elements, especially strontium 90 which causes genetic damage, birth deformities and mutations. Closer to home, a recent newspaper article described the alarmingly high number of male college students in the U.S. who tested as impotent. In a strange circuitous way this echoes the myth of Uranus, who was rendered impotent by Gaea, the Earth's revenge. From the blood of Uranus mixed with sea foam, the avenging Furies were said to spring, and also curiously was beautiful Aphrodite, the goddess of love.

Russell had said that: "Radioactivity is man's discovery of how the human race can die quickly, and not be able to propagate its kind for many long centuries." He also warned of greater dangers to come. "The greatest radioactive dangers are accumulating from 8 to 12 miles up. This seems to be ignored. The upper atmosphere is already charged with death dealing radioactivity for which it has not yet sent its bill. It is slowly coming, however, and we will have to pay for it for another century, even if atomic energy plans ceased today."

Here again we encounter the ancient Uranus, also known as the Overhanging Heavens,¹⁴ "the generative power of the sky, which fructifies the earth with the warmth of the sun and the moisture of the rain." But now the bright overhanging skies are charged with radioactive clouds falling silently "little by little... in the rain and snow and dew, onto the earth, the rivers and the sea."

Dr Wilhelm Reich also described how the clear desert atmosphere became grey and lifeless, charged with Deadly Orgone Energy immediately after atomic tests.¹⁵ And nowhere is safe. Samples of radioactive strontium have been detected from the snow of Antarctic to alfalfa in the fields of Wisconsin. The Hopi Prophecy also warned of the catastrophic results if uranium was taken from the sacred lands for the wrong reasons.

"So we begin to see more earthquakes, we see changes of seasons, severe winters, severe droughts, or maybe big winds killing people and destroying property, and great flooding by rain, and maybe mountains blowing their tops, and land sinking, and then towards the last lightning starts hitting people because we have not followed the law of the Great Spirit... We now stand at the final stage as predicted by the Great Spirit."¹¹

The facts speak for themselves. Earthquakes, floods, droughts and major storms... they are all on the increase as even a casual observer of news reports cannot fail to notice. At least 15 million people are expected to die of starvation and disease in Africa over the next year due to drought. Underground nuclear testing contaminates the vast underground aquifers beneath the desert, and although scientists say "there is no connection" swarms of earthquakes shake the planet within days, even hours, of these gigantic chthonic blasts. There were more earthquake deaths reported in 1990 than during the whole of the 1980s.

A fascinating book *H-Bombs Have Us Quaking* details the major earth movements following the atmospheric tests of the 1950s. With good reason the author calls nuclear power

"the scientific religion of death."¹⁶

ALCHEMY & THE SHADOW SCIENCE

The ancient alchemical tradition with its metallic and planetary correspondences is a profound science of transmutation, concerning both consciousness and substance, describing life and death and the renewal of life as a continuous metamorphosis. But while this noble science seeks the healing elixir of life, the debased shadow science of nuclear technology has brought misery and death to the planet, and casts a shadow upon our children and their descendants for thousands of years to come.

The end product resulting from the decay of uranium is lead, while alchemy begins with lead as the 'base' metal which is purified and ultimately transmuted into the gold symbolic of spiritual perfection. The discovery of uranium and its subsequent use in warfare and nuclear technology has irrevocably altered the course of human evolution. A gateway has opened into the abyss and humanity balances precariously on the edge.

In the occult Qabalistic tradition, the planet Uranus is attributed to the 11th sphere on the cosmic Tree of Life, the 'false' sephira called Daath, and the Gate of the Abyss. Here is the knowledge of death, a sudden and explosive knowledge as the blackness of the abyss is lit with the lightning flash of illumination.

Daath is the ghost, the shadow of reality, as occultist Kenneth Grant writes; it is the place of crossing-over or "reversal to the source of Non-being... Daath being the Gate of the Abyss is the point both of ingress into noumenon and of egress into phenomena; in other words it is the gateway of the manifestation of non-manifestation."¹⁷

Here lies the secret of duality sought by etheric scientists such as Le Bon, who showed "that matter is not eternal, that it constitutes an enormous reservoir of forces, and that it disappears by transforming itself into other forms of energy before returning to what is, for us, nothingness."

The sphere of Uranus corresponds in the human body to the subtle energy chakra called Visuddha in the region of the throat. It is the source of the Word, "the creative power of the mystic Sound that, according to the old tradition of India, pervades all spaces," a concept echoed in the words of Moray, who wrote: "There, at its very foundation, matter consists of an electric charge which governs the very motion of the planets and suns. I consider gamma rays or radio activity an electrical action only of a different rate of vibration. If one, therefore, sets up a sonic oscillation, a sonic oscillation existing in the

realms beyond the light rays, one will be in harmony with the oscillations of the universe, the energy which is coming to this earth continuously, oscillating back and forth in a definite sonic."¹³

The highest Uranian sciences show clearly that the infinitely small particles of matter obey the same universal laws from atomic space to planetary and stellar space. As human consciousness reaches further out into the distant regions of the solar system, we encounter new streams of cosmic energies, alien radiations from the deepest abstractions of space...and whether we are aware of it or not, we too are transmuted, and changed into a new form of life.

REFERENCES

1. Astrology Karma and Transformation - Stephen Arroyo, CRC Publications WA 98662, 1978.
 2. The Voudon Gnostic Workbook - Michael Bertiaux, Magickal Child, Inc. NY 1988.
 3. The Sirius Mystery - Robert K.G. Temple, Futura Publications Ltd., London, 1976.
 4. Uranus and Neptune, The Distant Giants - Eric Burgess, Columbia University Press, NY, 1988.
 5. Tales About Metals - S. Venetsky, Mir Publishers, Moscow 1981.
 6. The Evolution of Matter - Dr. Gustave Le Bon, BSRF, Garberville CA. First published 1945.
 7. CRC Handbook of Chemistry and Physics - 70th Edition, 1898-90. CRC Press, inc., Boca Raton, Florida.
 8. Atomic Suicide - Dr Walter and Lao Russell, University of Science and Philosophy, Waynesboro, Virginia, 1957.
 9. The Truth About Chernobyl - by Gregori Medvedev. Book review - The Economist Newspaper, 27 April 1991, London.
 10. McGraw-Hill Encyclopedia of Science and Technology - Vol 19. McGraw-Hill c.1987.
 11. Hopi Prophecy - Video - presented by Land and Life, Japan. Produced by Kiyoshi Miyata.
 12. Living Sphere Magazine, Vol I, BSRF, Garberville CA
 13. Radiant Energy - Dr. T. Henry Moray, BSRF, Garberville, CA. First published 1907.
 14. Dictionary of Classical Mythology - J.E. Zimmerman, Harper and Row, NY 1964.
 15. Contact with Space - Dr Wilhelm Reich, Core Pilot Press, NY 1957.
 16. H-Bombs Have Us Quaking - Thurman C. Dibble, BSRF, Garberville, CA.
 17. Nightside of Eden - Kenneth Grant, Frederick Muller Ltd., London, 1977.
- The Ether and Its Vortices - Carl Frederick Krafft, BSRF, Garberville, CA.
The Structure of the Atom - Carl Frederick Krafft, BSRF, Garberville, CA.



THE WORLD RUNS ON AC

by Larry Spring

225 Redwood Ave., Ft. Bragg CA 95437

LARRY SPRING'S ELECTROMAGNETIC SPHERES

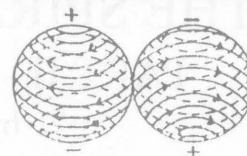

The sun radiates all our solar energy across 93 million miles of space. There is no other way for the energy to get here. There is no way for energy to conduct through 93 million miles of atomless space. Conduction anyway, according to my original experiments, is atom to atom radiation.

Radiation of magnetic energy, according to my antenna observations, takes place only when one circular magnetic field of reverse polarity forms inside of a circular magnetic field that forms around a current carrying conductor. AC radiation can therefore occur only when an electrical current reverses direction and comes back on the same electron and resulting electrical current path it went out on. This observation says steadily flowing direct current, although it can form an expanding magnetic field around its path, cannot radiate free space traveling units of energy. An interruption of the direct current flow would cause a collapse of the magnetic field. While expanding and while collapsing the magnetic field of 60 cycle per second alternating house current (AC) can induce an alternating current in a secondary conductor. This takes place in a transformer.

Every transmission of magnetic energy through space, from long wave radio transmission through television, satellite, visible light to gamma rays, takes place by one circular magnetic field forming inside a reverse polarity circular magnetic field around a rapidly alternating electric current conductor causing the magnetic field to continue to expand at terminal velocity of 186,000 miles per second, which is the speed of light. This very dense energy expands in a global form and eventually separates into spherical units each proceeding in its original direction thus thinning by the square of the distance. These spherical units originally were viewed by Newton, Einstein, Max Planck and others as simple packets of energy which gave rise to the quantum theory. By experimentally analyzing these energy units in the C band satellite, UHF television and VHF television range 150,000 to

9,600,000 times the diameter of light photons, I, Larry Spring, was able to determine the spherical shape, size, alternating polarity magnetic structure, compressibility and bounce characteristics of radiated magnetic energy, and further recognize how and why they radiate.

These alternating polarity magnetic fields are formed around an alternating electrical current carrying conductor as per Oersted's right hand rule. They have time to grow in one polarity during one half cycle and the reverse polarity magnetic field grows during the second half cycle of the electrical current on a resonant length conductor. These spheres of magnetic energy can be measured at 1/2 wavelength in diameter.

These TV antenna current and radiation observations by me appear to hold true for lower frequency radio transmission and higher frequency visible light and beyond; so I presume the same action is to be taking place at the atomic level. This presumption would call for a back and forth alternating movement of the electrons in an atom. Visible light at 600 trillion alternations per second would better be described as an electron vibration within the atom.

The actual distance of movement of electrons in an antenna is minute as compared to the relay effect, passed on to adjacent electrons, which is the electrical current. This current travels at close to the speed of light. I, Larry Spring, have measured this electrical current speed at TV frequencies in lead line. A tiny photon of visible light 1/2 wavelength in diameter is, according to my experiments, about 1/100,000 inch in diameter as calculated using accepted measurements of wavelengths of mid-range visible light. The representative atom's diameter at sea level and average temperature is about 1/1,000 the size of a photon of visible light, so a photon must develop around the progressive relay current caused by electron movement in a series of atoms pretty much like a series of capacitors used as an antenna element.

BOOKS BY LARRY SPRING

Now available from BSRF:

MY ELECTROMAGNETIC SPHERICAL THEORY AND MY EXPERIMENTS TO PROVE IT

40 years of Larry Spring's original analysis of radio, TV and satellite antennas, including his personal observations, experiments and theories of the electromagnetic spectrum from DC, through 60 cycle AC, to light. Also contains results of experiments on: Satellite TV receiving dishes, VHF and UHF TV antennas, and Rhombic TV antennas. Second Edition. 187pp \$20.00

ELECTROMAGNETIC HEAT Gravity and magnetism, Heat as the breath of life, Solar heat, Frequency and time, Reflection, Diffusion, Absorption and Heat conduction, Light, heat and electricity. 127pp \$10.00

ELECTROMAGNETIC SEA IN WHICH WE LIVE Electromagnetism neither wave or particle, Laws of physics with amendments by Larry Spring, Energy in space, Perpetual motion, Magnets and Monopoles, Atomic analysis, Larry Spring's atomic model, Tidal waves and electrical pulses, massless and weightless energy. 284pp \$25.00

NOW I SEE A continuation of Larry Spring's electromagnetic observations. Shape and size of energy, Larry Spring challenges explanations of electrical field and heat, Force fields, Photons, Transparency - Reflectivity, Sound, Neutron - Electrical dipole. 113pp... \$10.00

ELECTROMAGNETIC FORCITOS Logical physics, Seven ingredients, Relativity, Larry Spring's Gravititos, Electritos, and Magnetic Forcitos -- components of lines of force, Escaping gravity, Determining radiated energy size, Retina of eye is antenna field. 136pp \$12.00

SPHERICAL ELECTROMAGNETIC QUANTUM An excellent introduction to Larry Spring's theories which he bases on experimentation and observation of electromagnetic energy. 28pp \$3.00

Send orders to

BSRF, Box 429, Garberville CA 95440

Add \$2.50 p&h first book, \$1 additional.

Californians add 6% sales tax.

THE SPIRAL COIL M.W.O.

PART II - HOW TO BUILD

by Lou Schad

In Part One I explained how the spiral coil M.W.O. evolved and how I came to build it and notes on things I have learned about it and its use. I also explained with drawings how to build the main spiral coil. For those of you who wish to build this unit, I have added additional drawings and notes so you can build the rest of the coils, base, etc.

Before I begin I would like to address an issue that has bothered me for some time, it pertains to my M.W.O. and maybe other M.W.O.'s in general. It is a situation or function that has been ignored by many or all but a few. In my article in Part I, I said all coils on this unit must be right hand coils. What I am referring to is what I call RIGHT HAND SPIN. In my study of Lakhovsky's and others work, I have not been able to find any information pertaining to direction of spin, although he gave very precise directions -- how collars, belts, bracelets etc. were to be made. Did he know and was it his secret? Was he not telling? Lakhovsky stated that his M.W.O. stimulated the twisted filament or nucleus of the cell, and the cell oscillated according to its natural frequency. A weak oscillating cell would increase its oscillations back to normal. The question is, do certain oscillations cause the cell to spin right hand or left hand, or clockwise or counter-clockwise, if the frequencies spin right hand or left hand? Some might say -- what difference does it make. The people who use or practice the Five Tibetan Rites always spin right -- never left. Sir Lawrence Bragg (Nobel Prize winner) discovered that healthy people have "RIGHT HAND" spinning blood. And physicist Dr. E. Mersmann discovered that people exposed to electronic smog have "LEFT HAND" spinning blood, the same as people who have cancer -- they also have "LEFT HAND" spin blood. Maybe if the earth spun in the opposite direction, left hand spin blood would be normal. So, is left hand spin or right hand spin important? Yes, I think so. I have purposely made and used left hand coils and they made me feel sick and ill. There is an instrument that has been built that emits weak pulsed electromagnetic waves that causes the blood to spin right hand in people who have left hand spin blood, however if the unit is removed the blood will go back to abnormal left hand spin.

If you put your hand in a bucket of water

you can spin it to the right or to the left -- is this polarity? Does magnetic polarity have an effect on matter causing right or left spin? Yes, it seems to. But how about induced spin direction on a non-magnetic or non-electrical energy or wave? If I hold a magnetic compass near the spiral coil of my M.W.O., I get nothing -- no needle movement. If I hold a pocket radio under the coil with vibrator and tune it off station, I get static on A.M. from about 80 on down, none above 90 and up, but I don't think that static is coming from the vibrator. Warning: I damaged my radio by using it for testing. At first I thought it was the battery, but a new battery did not correct it. Sometimes when I turn it on now it doesn't want to come on, by flipping the switch on and off several times it then works. I had no problem with this radio before I used it for testing.

Whatever the answers are, I would suggest you use right hand coils. Look very carefully on pages 113 and 114, these are right hand coils in relation to the subject, (ref. The Secret of Life). If you build the spiral coil M.W.O. you will have the basic unit. You can experiment and try all types of coils and spirals, as I said in Part I, it is only limited by your imagination. I find it fun and interesting to try unusual and weird coils, it's not expensive and you only have to remove a couple of screws, no big deal.

I have been thinking of building a cheap copy of Lakhovsky's coil of tube and wire, also a foil coil of equal size, to test if the coils when vibrated emit equal energies etc., and what the differences would be. It may answer the question why some of the foil coils don't seem to produce the results as good as some would like. In Lakhovsky's book there are pictures of, and he speaks of, the oscillator coils of Hertz. There is a striking resemblance of Lakhovsky's coils on his oscillator antenna to Hertz's coil. Could he have been influenced by or borrowed the Hertz oscillator coil for his unit -- did he expand upon the base of Hertz's work for his antenna coil? (interesting thought)

Enough digression -- back to our spiral coil building project. If you look at drawing #3 you will see that it is self descriptive, giving diameters, lengths etc. We make most all of our unit out of schedule 40 PVC plastic

pipe. Take enough care to make your cuts square and clean, debur the ends of the tubes so they will slide into the glued slip fittings correctly. Now, here comes the stinky part. If you want your unit to look nice, you will have to clean the tube, (after cutting), taking off all the dirt, the ink lettering etc. I use a laundry tub, a small amount of water, laundry detergent, Comet, and some wet or dry #200 sandpaper and a lot of elbow grease.

Warning: PVC glue sets fast, in a matter of seconds. I put glue on the female fittings only -- none on the male side, slide it together firmly and whack it with a short piece of 2 x 4. Glue part #7 to part #8 and drill a 5/16 hole through fitting -- this is so you can tighten or remove the threaded fitting by inserting a phillips screw driver or rod in the hole. This makes your unit portable.

Glue pieces 1-1-5-4-4, also 3-3-5-4-4.

Now glue part 2 to part 6, also part 3 to part 6.

Thread assembly 7-8 (large vertical tube) into assemble 2-6-3.

We will slide assembly 11-5-44 onto tube #2, but we will not glue it. Place this on a flat table, and adjust tube 8 so it is vertical.

When you get it where you like it, glue assembly 33-5-44 to loose tube 3, let this dry for 20 minutes.

Now remove assembly 11-5-44, apply glue to fitting #5 and glue it to tube #2 on your flat table. You now have the base finished.

Glue the rest of the tubes and fittings together on your table. NOTE: Do not glue parts #19 and #20, we leave these loose and just set them in place, as we may add something additional here later.

NOTE: Before you glue tubes #11 and #15, cut some one inch diameter .050 aluminum tube full length of tubes and slide them inside of plastic tubes, this eliminates sag. Drill a 1/8 inch hole through plastic tube and aluminum tube, screw a #8 sheet metal screw through both tubes. Tube #11 has holes in it so we can adjust the height, drill these 2 inches apart, 5/16 inch holes. We insert a 1/4 inch wood dowel through fitting #10 and through tube #11.

We drill 2 holes in tube #21 and thread them 10-24, we fasten our spiral coils and antenna to these. The first hole is drilled 5/16 of an inch up from the bottom edge of the tube and the second hole is drilled 3/4 of an inch from the first hole.

When you buy your 1-1/2 PVC tube, get a piece with a flared end, as we set a reducer fitting in it to make a sleeve for the #11 one inch tube. To keep tube #11 guided at the bottom of tube #8, drill 3 holes at the bottom of tube #11 equally spaced around the diameter and insert 3 #8 sheet metal screws.

Parts #9 and #10 will have to be filed out or machined out so the one inch tube will slide through them.

Part #16, the vibrator base, is made of flat stock PVC. If you cannot buy it from a plastic supply house, cut a couple pieces of 1-1/2 PVC tube about 3-1/2 inches long, cut them again length wise, so you have half tube pieces. Place the half tube pieces between two - 1/8 inch aluminum plates and heat in a stove oven with a brick or weight on top. Let them cool and the plastic will come out flat. Layout and mark parts on flat sheet and cut out.

Glue all the pieces of vibrator base together and fit to tube #15 and glue it tight. A wood match works wood to lay glue in joints.

Make and fit your metal brace from aluminum or non-corrosive metal and fastened with two - #8 sheet metal screws. Cut out part #23, fit it to T - #22, drill two holes for banana receptacles and glue securely, also cord holder #14.

Make your small spiral coil from .0625 low carbon stainless steel heli-arc welding rod -- 36 inches long, do not twist wire, use as is. You can get this from any welding supply; get

4 or 5 pieces. Also make antenna from same wire. To make small spiral use the full length or rod. Start by forming an eye on one end for the 10-24 screw. Move down 3 1/4 inches and form spiral same as large spiral coil, also bending end tip in. Put an offset kink in the stem so it will pass through the main coil.

The tube coils are made from #19 shellac insulated coil wire, 12 to 14 turns. I tight bend a 90 degree bend, so I have a 1 inch long tail. I place this parallel on a pencil or wood dowel and tight wind the coil. Grip the wire tail and dowel with a pair of pliers. Remove the dowel and freeze for 30 minutes, warm to room temperature. Grip the ends of the coil with your thumb and middle finger nails and stretch the coil to the desired length, refreeze for 30 minutes. Bend long tail of coil 90 degrees and fit to banana plug. Trim short end to 3/4 inch, clean and solder pinch clip to coil. The pinch clip is made from light gauge hard stainless or brass. Blank size is 7/32 x 1-1/4.

After you have everything glued and finished put a coat of auto polish on PVC tubes, as this keeps them clean and they will not finger mark or get dirty. Also put a coat of

vaseline on the threaded fittings so they can be removed easily as they tend to stick.

If you are, or want to be, the serious experimenter type, buy a note book and keep records and notes. Keeping a log with dates, exposure times, etc. can be a very useful tool to compare results of different coils etc. I would welcome hearing from you on the use of the spiral coil M.W.O., i.e. your success and problems. NOTE: Don't expect results in 2 or 3 exposures, as this unit is more gentle and may require a longer time of weeks or several months to get permanent results. To this date I have not had a single report from anyone for over-exposure if used with common discretion. I have used belts, collars, wire loops etc. with the M.W.O., this seems to multiply the energy. I also have used a spin magnetic unit with a reticular energy filter before and after M.W.O. exposure. This seems to work well for joint problems.

Please Note: Lou Schad does not manufacture or sell this MWO. He is giving his knowledge and experience as a gift to the world. He may be written c/- BSRF.

LEGEND

USE P.V.C. (WHITE) SCHEDULE 40

KEY

L=LENGTH D=DIAMETER C=CUT
T=TUBE T.F.=THREADED FITTING

PART # DESCRIPTION (in inches)

1. T-D=1-1/2, CL=10
2. T-D=1-1/2, CL=15-1/2
3. T-D=1-1/2, CL=8-1/4
4. CAP-D=1-1/2 (4)
5. TEE-D=1-1/2 (2)
6. TEE-D=1-1/2 THD'D
7. NIPPLE-D=1-1/2 THD'D
8. T-D=1-1/2, CL=28-1/2
9. REDUCER - D=1-1/2 TO 1
10. REDUCER - D=1-1/2 TO 1 INV.
11. T-D=1, CL=28-1/2
12. T.F.-D=1 NIPPLE
13. ELBOW - D=1 - T.F.
14. CORD HOLDER (ELEC.)
15. T-D=1, CL=20-1/2
16. VIBRATOR BASE
17. METAL BRACE
18. TEE-D=1
19. T-D=1, CL=3-1/4
20. CAP - D=1
21. T-D=1, CL=5-1/2
22. ANTENNA
23. F.T.G. BANANA RECP.

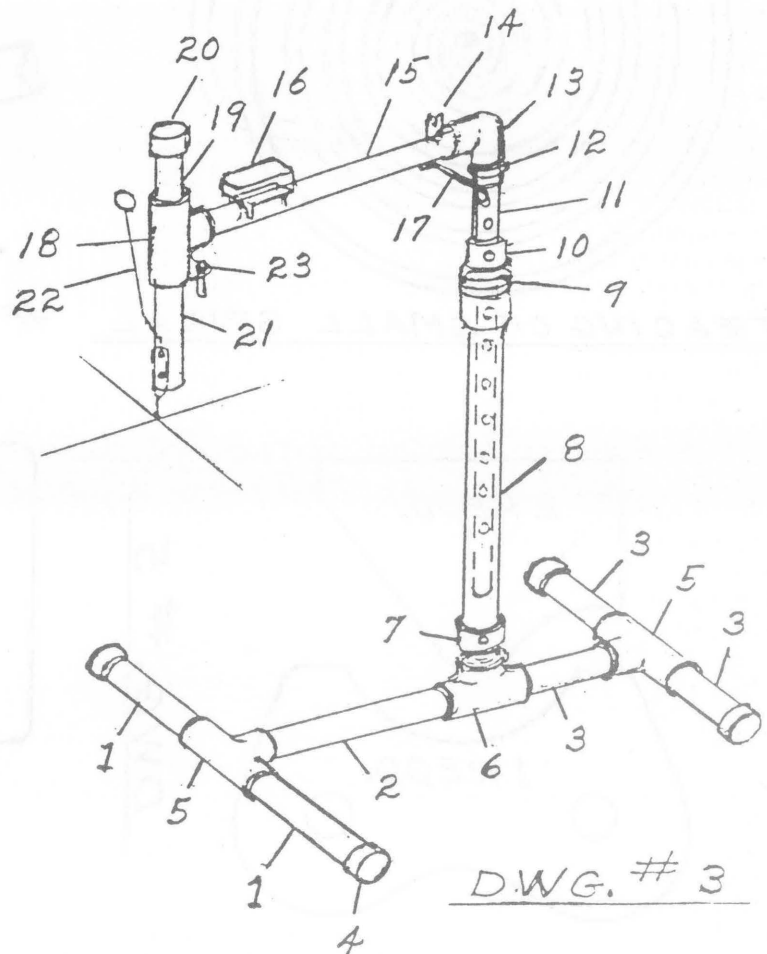

**COIL SHOCKER FOR
SCHAD SPIRAL COIL M.W.O.**

This unit provides a D.C. shock to the spiral coil. It should be built in a wood box, or grounded metal box for safety sake as we use 115V A.C. power source. All the parts can be purchased from an electrical supply, except auto bulb and socket. Get these from an auto parts supply house.

The Leviton dimmer is not necessary, but it gives more control. I use a ceramic base for 40 watt bulb. A smaller transformer can be used, but I find the 3A-12V best. It is nice to add a handle to the box. I dropped mine once. Put ventilation holes in the box, and rubber bumper feet on the bottom.

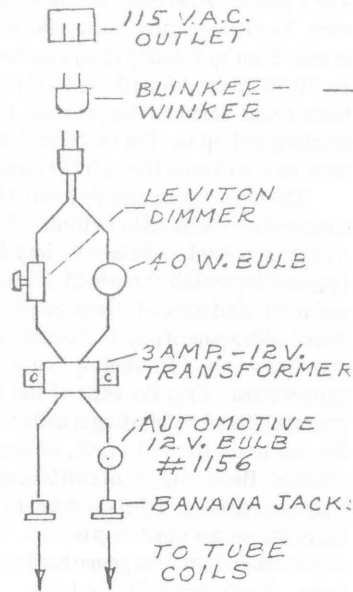

POOR MANS
COIL SHOCKER

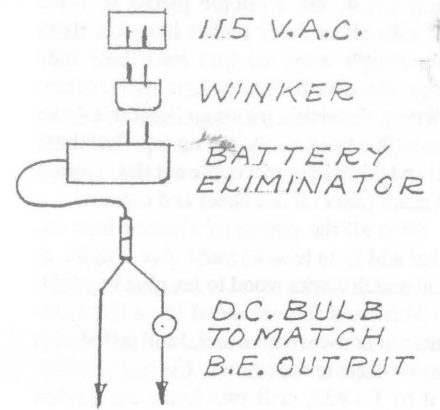

DWG. # 4

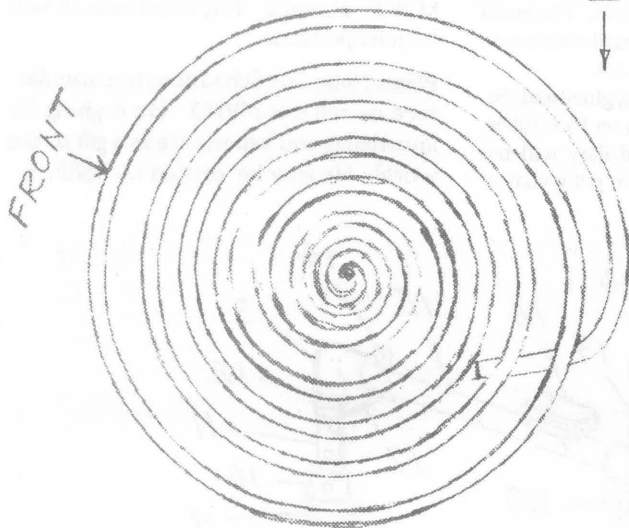

TRACING OF SMALL SPIRAL

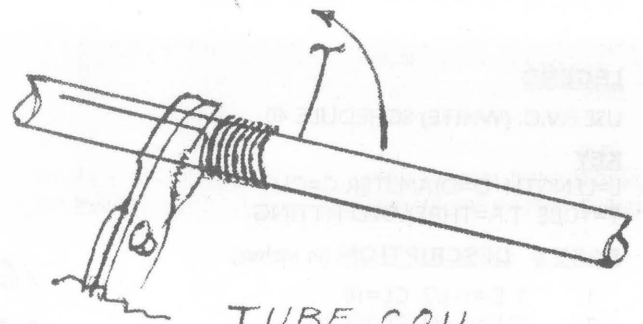

TUBE COIL
#19 COIL WIRE 2 REQ.

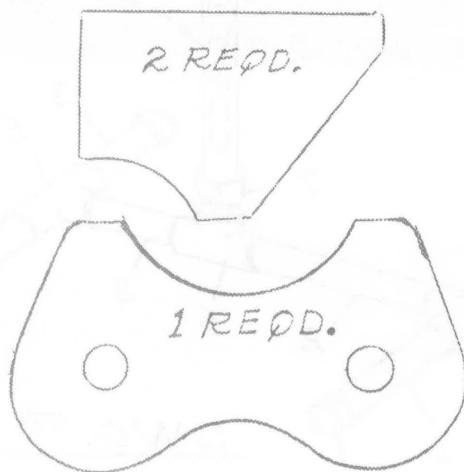

DWG. # 5

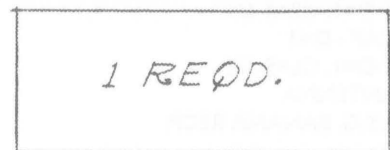
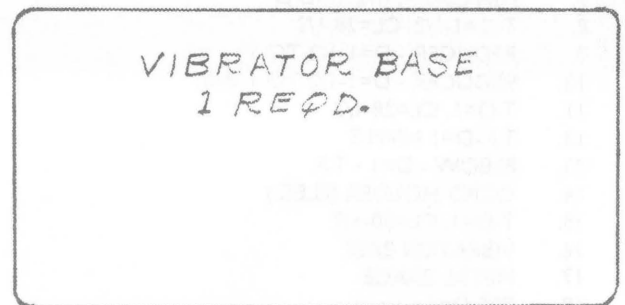

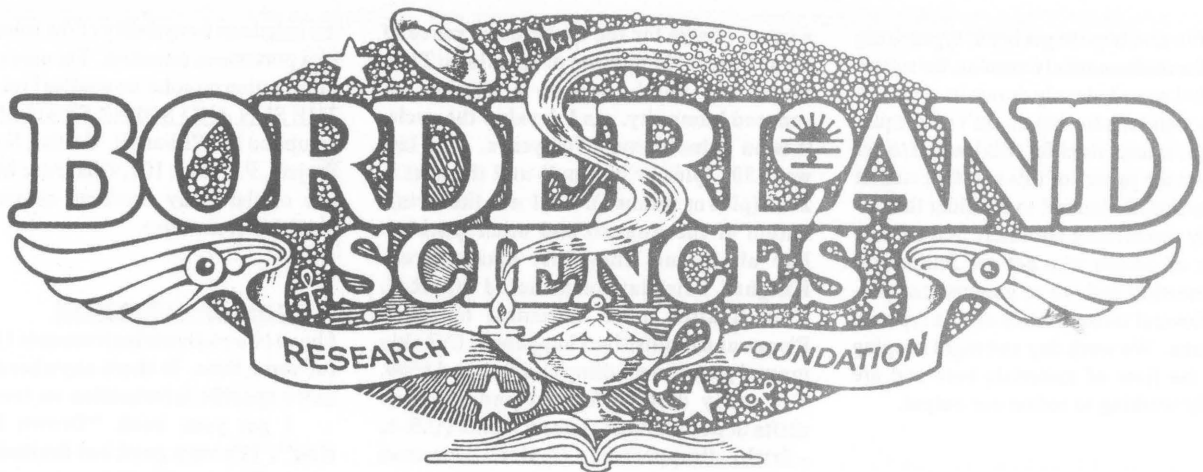

B.S.R.F. BULLETIN BOARD

DISTANT VISION CORRECTIONS

Thank you for your excellent book review in your journal [JBR, Mar/April 91]. We already received one order for my book!

If you don't mind I should like to correct you on a couple of things. The first transmission (two dimensional) was a triangle. I didn't understand your statement re the Multipactor — "...not counting the heat!" This was the first cold cathode tube — and there was no heat.

At the bottom of that column you say Phil's fusion work was in Indianapolis. This should be changed to Fort Wayne, Ind.

We really appreciate your including our name and address.

I find your Journal to have many very interesting articles. There are many people out there who are truly working to extend the Borders of the public consciousness. More power to them — and to you for giving them a sounding board where their research can be aired.

Sincere best wishes to you.

Pem Farnsworth
PEMBERLYKENT PUBLISHERS
2121 Garfield Ave.
Salt Lake City, UT. 84108-3013

Thank you for your corrections and kind comments. We regret all errors and appreciate all corrections. I do hope a lot more orders have come to you for DISTANT VISION, the biography of Philo Taylor Farnsworth II, as it should be required reading for energy researchers, as well as being recommended for all as a first rate book. My comments concerning the Multipactor did not come entirely

from my reading of the book, but were added in from my brief experience with the Multipactor that Pem loaned to Eric Dollard for research in 1988. The article The Farnsworth Multipactor Tube from RADIO, October 1934, which we reprinted in this journal (Sept-Oct 1988 JBR), states, "An undistorted output of 25 watts was obtained from an input of 25 watts." The interest in the Multipactor was because Eric said that it would operate at 100% efficiency "not counting the heat" put off by the tube during operation, which I assumed was from whatever lit up in the tube when it was electrified. The plan was to engineer this effect. I remember quite well the discussions on the Multipactor with Eric and others, including potential investors in our (now defunct) lab. This is when discussion surfaced concerning a similar effect in radar tubes. Being a layperson who some days has trouble remembering an anode from a cathode I just absorbed what I could. It is entirely possible Eric was working on a misunderstanding and I appreciate the correction. Obviously, Philo Farnsworth II went beyond whatever was happening in the Multipactors and produced working nuclear fusion in 1964 in Fort Wayne, Indiana, a feat still claimed to be impossible using modern approaches. Perhaps IIT was too busy toppling foreign governments with their buddies in the CIA to promote the beneficial advancements being developed in their labs.

ETHER CORRECTIONS

I am rather pleased with the form in which my article was printed in your journal.

Unfortunately though, there are a few important flaws. In the equation which appears as a caption below the top illustration, the 2's are too large and low so that they look like factors instead of exponents. This equation should read:

$$(ct)^2 = (ct')^2 + (vt)^2$$

At one point in the text, a prime is missing from a variable so that the statement does not make sense. This occurs near the end of the first page of the article (page 25 of the journal). The text should say that x' is the distance as measured by the traveller parallel to his direction of motion. x' happens to be longer than x whenever v is not zero, because the traveller's measuring stick is shortened in his direction of motion relative to the ether, because of the effect of ethereal motion on the insides of physical objects. He doesn't directly perceive this shortening of his measuring stick because he and everything else that is moving with him is shortened in the same manner. The only other important error I can find is the exponent that is missing from the c in the formula for df near the bottom of page 27 of the journal. The c in this formula should be squared, and should look like this:

$$df = \frac{-fv dv}{c^2 1-v^2/c^2}$$

Some of your readers will probably appreciate the accuracy of the information.
Richard W.W. Allen
San Luis Obispo, CA

Thanks for your corrections. We regret all errors and appreciate the accuracy of all infor-

mation. We also hope to get better typesetting software for mathematical formulas, the square root symbol was obviously drawn in. I realize that our general readership doesn't read equations, but it is important for this journal to act as an outlet for papers of this sort that cannot find any scientific journal to consider them -- for merely mentioning the ether! We do have a number of people who get our Journal for this information and we're glad we can provide it. Several more articles of this type are in the works. We work day and night keeping up with the flow of materials here and are constantly working to refine our output.

THANKS...

I would like to thank you for your inclusion of the two-part article on Jack Derby and "Psychic Surgery" by Harvey Martin III in the current issue. They are a welcome boon to such people as myself.

These articles are unique in the metaphysical area. The first shows that the West can and does make contributions to this field. As for the second, many articles and books have been written on psychic surgery, but until Harvey Martin came along not a single one dealt with the background of the healing movement in the Philippines as this one does.

For me this is a most welcome trend in the Journal's coverage. The early Journals, of which I have seen a goodly part, dealt with the parapsychical in what appeared to be a naive and almost superstitious manner. Thanks, I believe, largely to you, the present ones have a more substantive approach.

Best wishes for the future.

George A. Carasso
Sarasota, FL.

Happy to hear that you find the Journal worthwhile. The encouragement we get from you members is enough to keep us in high gear. We certainly get enough articles for a large monthly issue, but there are physical limits in this universe such as time and money. We are trying to push beyond them and appreciate all the input. The materials that go into this journal are donated by sincere individuals who wish to help by spreading information. We have much to learn from east and west.

SOLAR STORMS

Solar storm mentality pops up as a theme in almost everything that I am finding. As it appears to me at this writing, earlier man had a very profound knowledge of the Solar condition. His monuments seem to reflect

a sense of awe for the cyclic occurrence of Solar flares of king-sized proportions: They scorch the Earth, and do a number on exposed humanity. As I develop the cycle, it is an episode every 700 years. The last was 1301 (plus or minus 1) and the next is 2001 (plus or minus 1). 1301 was the termination of the Anasazi and other pueblos. For all intents they just disappeared. Knights Templar terminated by R.C. Church after much cathedral building. Plague and inquisitions happened. Cahokia mound people dwindling and finished 1500. Too many deserts formed and changes/shifts in populations. Irland Mikla (U.S.A. - Irish) disappeared. Central American cultures declining.

I have read and re-read Constable's Cosmic Pulse of Life and then sent to B.S.R.F. for several to give to others.

Peace and Balance

Charlie Boyle
Danbury, CT.

Thanks for your insights on cyclic solar activity of which we hope to hear much more. Several years back I got quite involved in solar research, put to the back burners keeping up with Borderland administration, but I found

the long term irregularity of the solar cycles to be a portentous situation. For some excellent information on solar anomalies I recommend: THE SUN AND SOLAR SYSTEM DEBRIS compiled by William R. Corliss, Sourcebook Project, P.O. Box 107, Glen Arm MD 21057, one of the many excellent resource books available from them.

RADIONICS QUESTIONS

I have two radionic instruments I have used for some time. Is there anywhere I can get more specific information on treatments?

I got your book "Drown Radio-Vision". It's very good but limited on treatment. On page 21, (9th paragraph), "You will find in the text book a complete explanation of what takes place in the body over the nervous system." Do you have or know where I can get this text book or any other books that deal with the treatments, more so than the instruments?

Thank you for your time.

Robert Jungers
Jacksonville, OR.

The book referred to in the quote from our publication THE DROWN HOMO-VIBRA

New Developments in Astrosonics!

--- Cyclic Temperaments of sacred geometry constants--subtle, powerful alignment to the constant moves one beyond local system archetypal constraints enabling such phenomena as clearer and even verifiable past life memories, unfamiliar brain areas are stimulated for new slants on issues, more reliable advanced-being contacts, awareness beyond and above the crown chakra, and gorgeous often non-spectral electric colors are often perceived by hearing tuned chords in these new temperaments using astrosonic pitch-shift derived fundamentals.

--- 10 New single planet chords based on the new temperaments bring out the general meaning of each planet in a chart -- \$25 for an hour tape of a planet, or \$100 a set of 5 tapes pairing the planets in astrological complements for use on auto reverse player to balance the archetypes.

All personal aspect realizations are \$15/Aspect. Phone for details

All 50 1 hour generic tapes are \$25/ea.

Call for gratis over-phone samples.

Postal Money orders only, please.

Michael C. Heleus
Astrosonics Services
160 Washington SE #167
Albuquerque, NM 87108-2732
(505) 865-3169

RAY AND RADIO VISION INSTRUMENTS (Rate Atlas) is THEORY AND TECHNIQUE OF THE DROWN HOMO-VIBRA RAY. Aside from the listings in our current catalog we have several books in progress on radionics, one on how to build variations on the Drown instrument theme, and the other is a compilation of articles on Albert Abrams' instruments. Both should be out by fall and will be listed in this Journal when ready.

COMPUTERIZED "RADIONICS"

In reference to the Computerized Radionics article I would like to hear from you on any material you may have concerning this area of Radionics. I have just acquired a SE-5 instrument and we are having a Radionics seminar the last weekend in January here in Atlanta. You mentioned article(s) by Jay Christopher in this area. Just what is meant by your statement "The computer generated rates flashing -- are generated in a synthetic subrealm.?" Since I have been a member only since 1989 I do not have the article(s) in house. Can you help me out with this or any other info you may have along this line?

Keep up the good work, as we always enjoy the Journal and the work you folks are doing.

Jeff Jacobs
Atlanta, GA.

The articles by J.C. were in the Mar-Apr and May-June 1988 JBRs. We may include them in one of our forthcoming radionic books mentioned above. I do not consider the SE-5 a radionics instrument, but a psychotronic one. Many people have the two concepts confused into one, and it is a "borderland" area with vague boundaries. I go on my own definitions developed out of 18 years of study and research on the subject. I've commented on such in past Journals and perhaps will work into a future article to clarify the point. Basically radionic equipment deals with the transient radiations of matter via interaction with physical form. The resistors or capacitors, when turned, vary the geometric relationships between instrument and witness (testing sample), making the instrument, in effect, a tunable antenna. Computer instruments only digitally synthesize the rate-number onto screen. There is no analog relationship. Much of this dawned on me when we had our Tesla lab several years ago in Santa Barbara. Eric Dollard had a singing Tesla transformer, one that would take any analog audio output (record, tape or microphone), and emit the sound directly into the air via the discharge of the coil. I suggested that he try one of these

new-fangled CDs that everyone was raving about. Eric replied that the coil would not work with digital sound -- it had to be a natural transient and not synthetic/digital. Hence, the computerized "radionic" instruments appear to me to be working on purely psychotronic principles (focusing of psychic energy via instrumentation) rather than radionic ones (geometric interaction of radiation). Results can appear to be the same from either, depending on operator and such, but they are obviously different functions. How are people ever going to understand this field if they can't perceive the finer points? Ruth Drown trained her operators to NOT impress their psychic energies into the instruments as she felt it interfered with the true radionic process. This journal is certainly open to other viewpoints on this matter and we would appreciate hearing them.

VITIC POWER

I thank you for sending to me the information on the Vitic Power Rods. I would like to ask you if you could tell me what the Vitic Power Rods MAXIMUM energy strength is? (2,000 Gauss, 3,000 Gauss, etc.) and could you tell what is the Gauss strength of the magnetized iron in your Moon Rod? Again, I thank you for your time and I look forward to your reply.

Could you please send to me some information on what others who have used the Vitic Power Rods have said about them? Craig Briscoe
Kansas City, MO.

The response to the Vitic Research Project was beyond our expectations. We had to rush to manufacture more to keep up with orders, and have now caught up and are shipping same day order is received. We certainly look forward to hearing of everyone's results and will publish as they come in.

The strength of the magnet in the Moon Rod is 2300 gauss which is weakened considerably by insertion in the magnetized iron. The purpose of the insertion is because the original units were of magnetized iron. To create a permanent magnetic field in the iron a permanent magnet must be inserted. This is the only magnetism in the circuit so it is also the overall strength. This is a weak magnetic field intentionally and I actually tried to make it weaker than it is. The Sun Rod (carbon) is the main component, the magnet is auxiliary. For some reason or another people relate magnetic strength with quality of action and this is quite incorrect in this frame of reference. The magnet is used to amplify the carbon effect which is what we are research-

ing in this particular project. We are going for effect, which is quite profound with the arrangement we have. It was our intention to reproduce the original effect of the ancients and we feel we have found the closest possible relationship using modern techniques and materials. I spent four years working this out before we made them available.

VITIC AND BIOENERGY BUGGERS

Thanks for the last order! The material and books were incredible! I built the VITIC DEVICE and was pleased to get some concrete phenomena and auric field interaction with it! I could only obtain locally 2 OZ. ALNICO MAGNETS with a 12 pound pull, but the device obviously works and I will build a SUPERCHARGER VERSION when I can lay hands on some 50 LB. pull horseshoe alnicos. What occurs to me is to insert one of these devices into a prayer circle of folks with linked hands and a common group visualization or prayer of unified intention. The extra pure vitality could conceivably boost the power of group prayer! I'll bet you already have tried this and you probably know if it works or not.

I have been buying up a storm of Borderland material of late. The VITIC book! A System of Caucasian Yoga! The Cosmic Pulse of Life! Wow! What INCREDIBLE books! The upshot is that I have been experimenting, building and trying devices based on your revelations of obscure and/or ancient technologies.

Among these experiments, I made power rods (of sorts) and determined that they do move bio-energy. But this was without the details of copper and zinc jackets for the rods...and so, though I have the rods, I want your version of them. (Jan/Feb 1991 Journal, page 29).

Further, I'll tell you what I plan to do with them! I have built and use the Eeman screen technology for years and I am impressed with it! What I propose to do is use the VITIC POWER RODS AS THE HANDLES FOR MY EEMAN SCREENS, but that is not the end of it. These screens will be dual screens of copper and raw silk to convey a broader spectrum of bio-energies.

As an added adjunct, the silk enclosures of the metallic screens will contain granules of potent Lithium minerals quilted into the silk screen covers! The Lady Haroldine put me onto the beneficial value of these minerals. I think screens made in this way may have some very remarkable therapeutic values! If this experiment turns out to have merit, I promise to inform

Borderland Research of the results. It is difficult to give the "good stuff" to the world, but through Borderland, we can at least give it to "He who hath an ear to hear," as the Bible puts it.

I would also like to describe how to SEE BIO-ENERGY:

Upon reading "The Journal" of Jan/Feb 1991 I was elated to find that you had answered my questions about bio-energ's connection with FORM! We know, of course, that gross forms like mountains and buildings will reflect, refract, conduct and absorb various energies in the energy spectrum (mechanical, radio and video transmissions, etc.). Mountains and canyons bounce sound as echoes, serving as wave guides, reflectors, and condensers just as mirrors reflect and guide light energy. In my letter to you I stated that I have watched the little quantas of bio-energy follow form, but I didn't explain how or where. It requires a slightly "altered state" to do it, and being a fire walker, I am into altered states.

One of the situations in which I often came into visual perception of these luminous little critters, or energy packets, was at my job. I am a commercial artist and in my work we sometimes use a product called zip-tone to add shading or texture to ink drawings. This product is orderly patterns of dots or lines to provide quick shading effects. You cut out pieces from the printed sheets and stick them onto areas of your drawings to accent or shade your work. In doing this you leave a white hole (space) in an otherwise perfectly ordered pattern. That is where perception of this energy particle phenomena shows up. IT IS NOT CAUSED BY MERE RETINA FATIGUE! I am familiar with retina fatigue and this is quite different! Upon removing a chunk of this orderly pattern, I have seen in the resulting open white field left by the missing piece of "pattern," a river of incredibly tiny and incredibly brilliant entities that look like tiny suns. They flow along the directional lines of the pattern that was there a moment before, yet they are nothing at all like an after-image of the pattern! Working under a strong, nearby fluorescent light source is a condition that helps make the phenomena perceptible. I don't see the little buggers every time I cut the shading material, so it seems that one's subjective state at the time is a factor in this perception. To describe the state I feel works best, I would say, focused attention (be present here and now with what is before you) and hold no preconceptions. It is this kind of attention to the creation

about us that allows the perception of truth. I consider this to be the proper mental state of the true scientist. It's a state conducive to discovery. Too many alleged "Scientists" are only looking to verify the existing biases of our culture. That mental set makes discovery impossible!

You said "Don't keep forever on the public road, going only where others have gone." A big AMEN! to that! My motto since age 17 has been, "Investigate the anomalies! Look into those phenomena that our culture ignores. This is the path to an expansion of human knowledge!"

It can be a rough path, but if the human race is going to evolve and eventually become wise, somebody has to do it!

God Bless Borderland Research!
Art Khalsa, The Firewalker
Cedar Rapids, IA.

There is nothing that thrills us more than to see some active experimentation and we certainly look forward to your results. Your experiments for seeing bio-energy are most appreciated and we hope much tested by our members. They go hand-in-hand with the visual ray experiments given by Trevor in Cosmic Pulse. Thanks for all the input.

IMPLOSION RESEARCH

Thanks much for the quick servicing of my order! I've learned much.

I'd like to find out more about the work of Viktor Schauburger and who, if anyone, is carrying on with similar work in the US or Canada. I've read Schauburger's Living Water and Implosion: The Secret of V.S. by Tom Brown (BSRF). Where might I find the address(es) and name(s) of any person(s)/group(s) who do work/research on implosive power or resource reclamation (air, water, land) or health applications based on Schauburger's work?

Gordon Schwontkowski
Cary, IL.

We would like to know as much as possible about what is being done in the U.S., and abroad, to further Schauburger's work. Specifically:

Are there people/organizations working on any of Schauburger's concepts — either in the U.S. or abroad?

If so, are they concentrating on his water purification ideas or on his insights into free energy?

Is there any current research being done on Schauburger's concepts?

The reason for writing is to gather information which may lead to an accelera-

tion of the development of this concept and solve our energy crisis.
N.J., Simsbury, CT.

I would like to ask you two questions with regard to some research that I am conducting at this time, between pages 22 and 23 (Implosion book) you have illustrations of what are supposed to be the craft that Victor Schauburger built. The caption states that the Kertl firm in Vienna built these craft, but that firm's name does not appear in the Patent Registry nor is it in (today's) Vienna Telephone Directory! Could you clear this matter up for me — would you know how I could contact this firm or tell me where in Vienna it was located.

The other bit of information that I would like to have is as follows: During World War Two there was an Engineering team under Hitler's Armament Minister — Albert Speer — who did work on the V-7 or Feuerball craft. There was a Gentleman by the name of Habermohl that was part of that team, what I would like to know is his first name. At the end of that war he was transported to Russia so that he could carry on his work.

Thank you very much.
Henry Schuren
Stanhope, NJ.

First off, there are several groups in the US doing research related to vortexian energy and water: Jennifer Green, Flow Research Laboratory, P.O. Box 930, Blue Hill, Maine, 04614; Karl Maret, Metanoia Group, 3089-C Clairemont Dr. #322, San Diego, CA 92117; and Walter & Rhetta Baumgartner, Energy Unlimited, P.O. Box 493, Magdalena, NM 87825. Should anyone know of others we will list them as discovered.

The Kertl firm probably went defunct around the end of WWII. We have no current info on them. Basically, and this relates to all our books (as we always get questions for more info once the book is read), we put all available info into the book, we don't hold back. If it's not there we probably don't know yet, but always update as new material comes in. If any of our members have any further info on this matter, or know any more of Mr. Habermohl, we will run the info as it appears.

HENDERSHOT RESEARCH

I bought your books: "Some Free Energy Devices" & "The Hendershot Motor Mystery." I spent considerable time and money constructing a Hendershot Generator. I need more information regarding it, to correctly re-build it, to get it functioning.

Do you have any non-published details regarding it, that I could buy from you? Do you have names of people who made working models -- whom I could contact for advice?

I could contribute free info of parts sources for new/outdated parts, and my two important design improvements!

Dennis Corbin
RR 1, Box 64A
Arlington, IA. 50606

The only person I know who claimed to have a working model was the late Jerry Gallimore, and he said that only sporadic results were achieved. He turned his notes over to BSRF in the hopes that future experimenters would come up with more precise research parameters. We are certainly open to publishing any materials that would update the available research information.

We just got a mailer from the German Research Project, 23942 Lyons Ave., Suite 103-395, Newhall, CA 91321. The GRP "gatherers, translates, and sells via catalog information concerning German Flying Discs of WWII vintage."

MORLEY MARTIN

Two recent calls for help in locating electronic parts might find assistance from Antique Electronic Supply, 6221 S. Maple St., Tempe, AZ 85283. The company's Celanese-covered copper wire is their answer to a replica for cloth-covered wire and may work for Mr. Wood's purpose (Sept/Oct 1990, p23). Also, Mr. Nair (Nov/Dec 1990, p24) can obtain high-voltage capacitors from the same source.

I want to praise you for keeping the Morley-Martin book in print. The curious fact that no first name is given for this gentleman prompted me to consult the newspaper articles referenced in the book. A photograph of the man at his microscope was published in Le Matin. The caption below the photo clearly identifies him as M[onsieur] W. Morley Martin. How his first initial came to be dropped and his middle and last names hyphenated I have not determined. Do you happen to know whether BSRF subsequently published any follow-up information of Mr. Martin, and whether his heirs sought publication of his notes?

Please briefly explain (or cite a reference) the principle of detection behind the computerized radionic devices. In other words, what manner of transducer replaces the subjective response of a stick plate?

Many thanks for your inspiring publi-

cations!
Ernst Knoll
Mesa, AZ.

Thanks for the update on Morley Martin's name. Meade Layne published what he had on the subject in the late 1940s. He spelled the name in that manner and it stuck. We have corrected this in our current catalog and will update all future info. He did amazing crystallization experiments showing that living forms could be extracted from azoic (pre-fossil) rock. To quote Trevor Constable in COSMIC PULSE: "Renown awaits the enterprising young biochemist who treads this same pathway today..."

The computerized "radionic" instruments use a rubbing plate as does most standard equipment of the sort (excluding those using pendulum readings off the plate/s). It is the interior of the instrument that makes the difference, as is noted several letters back.

COANDA INFO SOURCE

From Rex Research (PO Box 19250, Jean, NV 89019) you can get copies of patents/articles just to mention Dr. Henry Coanda C4-COA (\$8.00) 5 US Patents...Patrick Flanagan F2-FLN (\$9.00) Neurophone, Kelly, Tesla, Abrams.
No Name

Thanks for the info. Rex's \$2 catalog is an amazing source for a wealth of info.

MYSTERIOUS BIG CATS

I am interested in Big-cats on the loose in Britain and abroad and I am particularly fascinated by cryptozoology -- the scientific study of unknown species of animals. I have written a book called "Big-Cats Loose In Britain" which I am trying to publish. Could I appeal to you to please send any relevant information that you possess on this subject to the address given. Do you have any useful addresses of authorities, organisations, and individuals who might be able to help me?

Have any of you had any sightings, livestock kills, (e.g. sheep, cattle, horses, poultry) or seen any clawmarks, pugmarks, pawprints, or heard any strange and unusual noises that could be assigned to a felid? If you could send me any records, reports, tapes, pictures, photographs, and descriptions of these largely unknown and mysterious felids (Big-cats and Wild-cats) in any area, I would be most grateful. All information will be treated in strictest confidence and will only be published with permission in my book. I shall refund all

postage and photocopying costs, within reason!

These cats are shy, elusive and nocturnal and they do exist, of course. I am talking about such creatures as the "Exmoor Beasts" and the "Surrey Pumas". They include such types and breeds as Pumas, Black Panthers, (Melanistic Leopards), Lynxes, Leopard-cats, and Jungles-cats. I have seen a puma on Exmoor and a Bob-cat (lynx) on the Mendip Hills of Somerset and Avon. I believe there are connections between historic Black Dog / Ghost Hound accounts and sightings long ago of large Black Panther-type cats, so I am interested in any local Black-Dog or Black Big-cat stories from the past you can tell me about.

Since August, 1986, I have been researching, investigating, and collecting as much evidence as possible on these cats. I have thus amassed about 1,000 letters in 25 files describing hundreds of sightings by people who are familiar with native wildlife and/or who are skilled at making observations such as farmers, game-keepers, foresters, and policemen. Another researcher recently estimated that there could be as many as 50 pairs of breeding pumas in the Southern Counties. I have no doubt that the cats have been living in the fields, downs, woodlands, and moorlands of Great Britain for centuries, in some areas. I have done fieldwork in various parts of Britain and this includes tracking the cats, visiting the areas where there have actually been sightings, and talking to local people and local officials in various authorities to find out if they have any information on the Big-cats. If I can help you on this subject, do please contact me. I shall look forward to hearing from you. Thank you very much and Best Wishes.

Yours Sincerely,
Marcus John De Gaughy Matthews
Horseshoe Cottage, 42, Potter's Hill
Crockerton, Warminster
Wiltshire, UK, BA12 8AD

Perhaps some of our members could help this gentleman with his curious quest.

THERAPEUTIC GOODS ACT

I am most interested in Healing and the Rife machine, Multiple Wave Osc., and other Healing Frequency Machines. I see now there is a Beck M.W.O. of which I did not know existed, of which I'd like to know more. It may interest you to know that under a new Therapeutic Goods Act in Australia, that the Rife Frequency Ma-

chine has been banned for use by Naturopaths etc. History is repeating itself! I would very much like to order video tapes of Rife Machine and Tour of Borderland Museum & others, but find the U.S.A. video tapes are not suited to our system of VHS in Australia. To convert is very expensive. The Journal has so much to read and make one think. Keep up the good work.

All Health & Harmony
Colin Robbins, D.C.
Queensland, Australia

Many thanks for your info. History is not quite repeating itself, as Rife never used the type of equipment bearing his name. The Therapeutic Goods Act sounds pretty dim, and we're sorry to hear of it. The more the old guard realizes its impotence, the more it will suppress all free expressions of new knowledge -- futile attempts from a dying force. We are working on getting a PAL video distributor for New Zealand, Australia and Europe.

LAKHOVSKY, RIFE, MORAY, ET AL

I have recently come across Borderland Science magazine after almost fifteen years. I could not remember the name of the journal, until I saw a copy on a neighbour's table. It is still a most fascinating publication.

I have been researching the field of electro medicine, and have come across the work of Rife, Moray and Lakhovsky. I'm sure there must be others in this field, who are still using this technology for healing purposes.

If there are any practitioners who are using these devices, I would be most interested to hear from them, or any individual who has had success with these modalities. Very best wishes to you in Garberville!

Tony Jordan
626 Courtney St
Victoria, B.C. V8W 1C1
CANADA

We hear from many people who use devices of all sorts in their research. We also receive many requests for referrals to these people. We cannot and will not refer people in this sense, due to the sensitive and dangerous nature of working outside the parameters of accepted medical and scientific knowledge. We will publish research results that are submitted, either with name or anonymously if preferred. If anyone wishes to contact you personally Tony, they are free to do so. This Bulletin Board serves as a nexus for this type of contact.

KLARK KENT CHECKS IN!

Just a note to say thanks for the mention in the Journal about the availability of the Golden Ratio Antennas from Super Science. And also to say that the articles on the continuing developments of the MWO are most welcome. Especially interesting is the comparison of the Beck MWO to the Lakhovsky original!

I have never seen an original Lakhovsky MWO. Only from the patent information can we really get schematic information, circuit diagrams, antenna structures, etc. As you know from all of the free energy patents circulating around, a patent wrapper and drawing is not really enough to produce the claimed device. If it were, then we should have many free energy devices in production today!

Several months ago a contact in New York made a generous offer to procure an original Lakhovsky MWO. I passed this information along to you and to others. So far no one has come forth to my knowledge with information leading to the whereabouts of an original Lakhovsky MWO. What this means is that we must grope our own way in replicating the technology first developed by Lakhovsky.

So I guess I owe Bob Beck a word of thanks because he was the one who made it possible for researchers to actually build a MWO. The information left to the world by Lakhovsky is (in my opinion) wholly inadequate to build and construct the device. The patent information is, like most patents, just not adequate to enable someone to replicate the device. And this brings up the question: Just what constitutes the original Lakhovsky MWO? We don't have an original device (and a bounty of \$100,000 has so far failed to produce one). The information given in the patents doesn't really tell us enough.

Perhaps Borderland Science can help out by continuing to publish articles about the MWO which emphasize circuit diagrams and construction details. In this way, Borderland researchers can redevelop this important technology.

As a final word, I enclose a letter we received from a customer. Since the letter is of the testimonial variety, it is best not to reference it in the Journal. But the point is that even a Beck adaptation MWO can seem to produce positive experimental results!

Best Regards,
Klark Kent
Super Science
Box 392
Dayton, OH 45409

Many thanks for your input and comments. Glad to hear you are open to new research. As you will see reported several letters down the line we have found some incredible new Lakhovsky info. Lakhovsky left excellent information -- it just never made it into English translation. But I'm ahead of myself. Here is the letter submitted to Klark, from a person known to us here also (just by chance).

Dear Mr. Kent,

At long last I get around writing to you and share some of my experiences with the MWO I bought from you.

The unit arrived on May 17, 1990 in excellent condition. Your packaging is superb. I inspected the unit superficially but, because of some professional problems, was not able to make use of it until October.

Let me comment first on general appearance and workmanship. While obviously not industrially produced, this is a well-built high quality machine, using fine components. Having been an electronics engineer part of my life (before I became a philosopher), I feel well qualified to make that judgement.

The instructions are generally adequate but I was glad that I did order your audio cassette, done by you with a fine dramatic flair, worthy of Christopher Reeve, who does resemble you. My suggestion: include the cassette with the MWO as a matter of course.

I used the machine about thirty times, sometimes daily, sometimes skipping a day or two for 35 min. per session, mostly in the High Power Radiator mode.

I suffered over a period of about fifteen years from a mild chronic bronchitis, some coughing in the morning with some phlegm, rest of the day just fine. The medicine men told me that I "just have to live with it". Though I am 70, I judge myself being in great health.

Now, your machine has definitely improved my condition. I know, of course, that my testimonial is worthless to you, since you cannot make, and do not make, any health claims. But still I thought you might want to know.

I do have several radionics machines (De la Warr and Copen) but we all realize that this is sympathetic magic; great stuff, though!

With best wishes, faithfully yours,
NAME WITHHELD
FOR OBVIOUS REASONS

ELECTRONIC ENTITY REMOVAL
Judging by the letters you receive and print

in the BULLETIN BOARD people are still experimenting and building MWO's. It should be accepted that no two MWO's will be identical due to different components, circuits, etc. Also, Lakhovsky did not have some mystical secret that is exclusive to his particular instruments; he built one that generated his required multi-frequencies and there are no doubt many ways to effect this.

The large MWO I built in 1966 worked as well as I could expect and, although I never use it now, its circuit can be regarded as a basic Tesla coil, starting out with a 12KV neon transformer. Other circuits I have experimented with unfortunately appeared not to give the same results. Your Handbook on the MWO should be the starting point to would-be experimenters keeping in mind that most of the 'transistorized' models do not have enough energy to effect the desired results.

A major point that never seems to be mentioned is that the subject should be seated ON AN INSULATED PLATFORM with the antenna about six inches from the back. In this way all the cells of the body are raised to their full potential for, say, ten minutes during which each cell can absorb energy at its one resonant frequency. The subject should ground himself for an instant before stepping off the platform. Then switch off the instrument. I found this procedure mandatory to obtaining positive results and have found it odd that this point has never been mentioned in the literature.

I might also bring up the very real possibility (discussed with Riley Crabb in the past) that at least part of the positive results obtained with the MWO could be attributed to the removal of spirit entities by the high voltage involved. Regrettably, Borderland appears to skirt this issue.

As I have stated before, the Journal is an important platform for the meeting of the minds and I wish you well in your efforts.

Robert A McLellan
Reno, NV.

Appreciate your input and valuable ideas. I'm certainly open to the possibility that the results obtained from the MWO could be attributed to the removal of spirit entities. This should also bring up the question of whether or not what is perceived as spirit entities (negative in this sense) could be also related to their potential physical anchors, i.e. virus and bacteria. Maybe we see the same thing but interpret differently.

As far as using different configurations to achieve multiple wavelengths, different ar-

rangements will produce qualitatively different results. A French horn and a clarinet will show the same frequency for the same note played, but the difference in quality of sound should be obvious to all. The major difference between the hookup of Lakhovsky's and Beck's units makes them fall into quite separate categories. A silver bell rings finer than tin.

MWO REPORT FROM PARIS

I finally managed to get hold of my friend (see BSRF Bulletin Board, Jan-Feb 1991) this morning but he is very, very busy and only gave me some of the information I wanted.

Firstly, he declined to provide any basic layout of the MWO because he is too busy and also because no two units were the same. Apparently Lakhovsky experimented all the time and each machine was a "one-off" model, different from the others.

The origins of the MWO are in Tesla's work. A French professor, Mr. D'Arsonval took some of Tesla's equipment and modified it. Lakhovsky used D'Arsonval's work to build his machine. Tesla heard about D'Arsonval's experiments and, convinced that D'Arsonval was stealing his patents, came to France with the idea of starting legal proceedings against the professor. However, he found D'Arsonval so courteous and charming that he returned to America having dropped the idea of court action.

My friend tells me that the whole secret of the MWO is in the "diffuseur". He further indicated two sources of information, both in French. A series of books have been written and published by the Study Group "Arkall" called "L'Emergence de l'Enel" dealing with all aspects of the MWO. They can be obtained from Professor Revatin, 21, Rue Louis Scocard, 91401, Orsay, FRANCE, that is if they are still in print. The second source is George Lakhovsky's book "L'oscillation cellulaire" which has been re-edited in Belgium. Unfortunately, my friend did not know the editor, so I suggest you will have to contact the American Embassy in Belgium and they should be able to give you addresses of bookshops where it can be obtained. Apparently, this book gives all the references con-

cerning the people I have mentioned (Professor D'Arsonval etc).

I'm sorry I can't be more helpful but the whole question seems to be much more complicated than I at first thought. In short, I'm afraid you will have to wade through "L'oscillation cellulaire" and the "L'Emergence de Enel" to see how Lakhovsky himself worked out the idea of the first MWO's.

Now that the Gulf war is upon us, with the prospect of higher gasoline prices, it might be a good idea if the Journal would 1) review the existing proven equipment for gas savings, 2) ask whether readers have anything to offer. As an example, when Haroldine was doing her research on Lithium, she told me that a small bag of lepidolite, immersed in the petrol tank, gave higher mileage. A letter in the Journal some months ago led me to use a magnetic appliance on my car, with excellent results. Years ago in the Journal there was a question of some gadget which produced a much more efficient petrol/air mixture and which might still be available. In short, Tom, I think this should be a regular feature - all your readers use cars and all of them want to get better performance for their money. If you did this feature, say, once a year I'm sure all your readers would be very grateful.

Ron Crossley
Solesmes, FRANCE

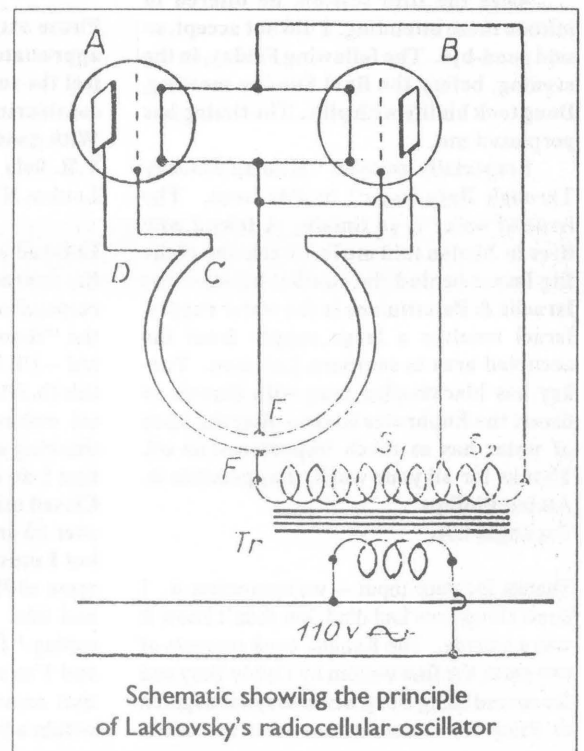

Schematic showing the principle of Lakhovsky's radiocellular-oscillator

Thank you Ron, your input has been most valuable and stimulating. Another European contact is following up your leads. The "diffuseur" (literally: loudspeaker or nozzle) would probably be the antenna, so the "secret" could very well be (as we have intimated over the years) in his mathematical arrangement -- a much more important consideration under Lakhovsky's antenna hook-ups than Beck's.

We are also happy to announce that we just have received the temporary loan of two of Lakhovsky's books in French: LA SCIENCE ET LE BONHEUR and LA TERRE ET NOUS. The first book has a number of MWO schematics, one of which is shown here without comment (see previous page). We are certainly looking into translating and publishing both books, a rather extensive and expensive project -- but a most worthwhile one. Anyone wishing to donate to this project (or any others we are undertaking) please feel free, it is much needed. These two titles will advance our knowledge of Lakhovsky's work far beyond what we know today. Many thanks to our friend Bill Van Doren for allowing the loan of such precious materials.

KAHUNA RELIGION OF HAWAII

I was surprised to know Doug Low had written this book about Daddy Bray. I was participating in a six week workshop Doug gave at his home. Some of the experiences were rituals -- wow.

After the fifth session, he offered to initiate those attending. I did not accept, so said good-bye. The following Friday, in the evening, before the final Sunday meeting, Doug took his life with pills. The timing has perplexed me.

I especially enjoyed "Human Ecology Through Raja-Yoga" in this issue. The issue of water is so timely. A friend who lives in Jordan told me last week one of the Big Issues behind the conflict between the Israelis & Palestinians is the water supply. Israel receives a large supply from the occupied area in southern Lebanon. Turkey has blackmailed Iraq with threats to divert the Euphrates River -- that the issue of water has as much importance as oil. Thanks for all your work. I appreciate it. Amina Phillips
Topanga, CA.

Thanks for your input -- we appreciate it. I knew Doug Low had died, but didn't know it was a suicide. The Kahuna book consists of two parts, the first written by Daddy Bray and the second being Doug's course syllabus given to Riley for dissemination after his death.

Curious connection as Huma teacher Max Freedom Long also committed suicide. We have heard other stories of deaths after putting out quality spiritual information. There is a book "Oracles and Demons of Tibet," written by a man whose long hyphenated East European name has long left my consciousness, who died mysteriously after releasing his book. "Oracles" is a technical manual of the mandalas of the gods and goddesses and their seed syllables, colors, etc. (I've searched long and hard to find another copy so please don't write asking where to get it.) A couple of similar cases come to mind but I don't have enough reference materials to list them.

Very interesting about the water situation in the mid-east, nothing of which has appeared on the "news." Makes much sense. One thing for sure, if this is the case it will never appear in the press -- they are too busy acting as propaganda agents of the U.S. military.

FAN MAIL

Keep up the terrific work!
Frederick J. Farran
Chicago, IL.

I think your publication (Journal) is superb and I don't want to miss any issues; please let me know when my current subscription expires so I can renew promptly.
Stefan O. Horvath
Columbus, OH.

Please extend my sub for 4 more years. I appreciate whatever you are doing and I feel the subscription to BSRF is a bargain considering what we get back from it.
With good wishes,
V.R. Sola
Louisa, KY.

Enjoyed your letter in the Jan-Feb issue of the Journal and empathize with difficulty responding to all correspondence. Reading the "Renewal Notes" made me feel like a kid -- I'll barely be 69 by the time you read this (b. 3/16/22). So many of my chronological contemporaries seem so *old* in their thinking and in their couch potato lifestyles that I do not enjoy associating with them. Closed minds are not a monopoly of those over 60 or 50 or 40 or whatever, or course, but I must say it is refreshing to read that some of JBR's subscribers are in their 70s and 80s. On my 60th birthday I began saying "I've got at least 40 more years", and I'm still saying it. Partly as token of that commitment, I am moving to Spain within a few months and plan to establish a

Healing Centre (name yet to be intuited). Also plan to make my house there as energy efficient as possible and my 1 1/2 acres as ecologically a blessing as possible. Why not start a whole new career in a whole new place with a whole new language? Keeps one *alive!*

Thanx for JBR and for the evidence that open, exploring minds and spirits still exist.

Robert L. Young
Baltimore, MD.

Really appreciate your efforts to keep the contents of the Journal at such a high level of relevance for so many issues.

Michael Heleus
Albuquerque, NM.

CONTACTS

I am interested in contacting people who are doing research on the connection between the I-Ching and hyper numbers.

David Kelly
1801 Mission St.
Santa Cruz, CA 95060
(408) 427-3487

LITHIUM LABS UPDATE

This is an open letter to thank the many participants for their interest and support of lithium research. Lithium Laboratories Limited catalog service has been discontinued for the supply of lithium crystals once in stock, has been sold out. It was totally marvelous to have witnessed how very much was accomplished through the free sharing exchange of experience, ideas, and information of the application of various lithium crystals. A portion of humanity can and did work together and each of us was able to benefit from that shared knowledge.

Surprises abound in research, I wonder how many people realize that birth control pills were discovered after much research to find a fertility aid. One sets out with a tentative idea in mind to note the possible beneficial results and any adverse side effects that might emerge along the way, before presenting these findings to a larger group of interested researchers who would add further value to the original research.

J. G. Gallimore, an author and advanced researcher now deceased, shared with me at the USPA conference in Portland, Oregon in July, 1983 after I gave the first Lithium paper, "that I'd find with the passage of time that *amblygonite*, a lithium crystal, would prove to be the most benefi-

cial of any and all lithium crystals so far discovered." I'd felt with the publication of the Lithium book, my share of work with the Lithium Research Project had been pretty much completed. Besides, I was most anxious to start working more with water research and develop a product line with Aqualithia.

Oh — not so, silently screamed the Universe late August '90 as *amblygonite* made its presence strongly known for a very specific application. Preliminary research and testings have been conducted these past months, showing very promising results. This research "tool" is now available for any researcher who may desire to utilize the *amblygonite* frequency and it is called the Trinity Pak.

At this writing I might share too, I am writing another book that will soon be published (again by BSRF) and titled "The Deadpecker Society and other related MYTHS." It was inspired by the research work and discoveries of Wilhelm Reich M.D., now deceased, a researcher probably equal to or much more advanced than Nikola Tesla in the realm of more complete knowledge. This book contains information about sex and energy to connect many of the missing links for the reader who often wondered but was never quite sure. The knowledge to be imparted is Universal and Ancient, the prose is modern, — "mine"!

To all who gave interest and support to the lithium research, again — many, many thanks. I extend my heartfelt appreciation to each of you. Should questions about lithium arise, please feel free to write (c/o BSRF, PO Box 429, Garberville, CA. 95440) and include a SASE. Shalom, Haroldine

THE TRINITY PAK

In the center of the brain there is an area called "The Cave of Brahma" (known also as "the heart of the brain") by Sanskrit texts, which refer to this area as the seat of resonance with the SOURCE ocean of cosmic vibrations. Close to this area is manufactured the cerebro-spinal fluid in which floats the whole brain and spinal nerves. The chemical pH of this fluid determines the resonance. The *Trinity Pak* has the ability to balance the pH of that fluid. This brings forth a feeling of greater well being and more centeredness.

The energy frequency of the *Trinity Pak* when worn, often allows more complete perception that usual — almost as if one sees into the heart of things, instantaneously. The *Trinity Pak* releases and erases the negative memory programming stored

in the cells of the body as incomplete emotional trauma. It aids in bringing that trauma painlessly into fruition, as completed perception floats into the Mind's eye dissolving all previous resistance. This opens avenues to greater awareness, through more potential release (do remember the only true difference between all human beings on this planet is the degree of conscious awareness.) When the *Trinity Pak* is worn during a session of body manipulation, adjustment, or massage, the work is aided for the "fix" remains more permanent and will not rapidly fade away. The *Trinity Pak* when worn next to the skin, serves as a protective barrier from external negative human energies.

Areas of application for position wearing may vary for each individual. When possible, dowsing, muscle test, check pendulum, or meditate with the Higher Self to find the most ideal placement area for the greatest benefit to/for the Self as a wonderful supportive energy tool. Partial list of placement suggestions: Placing the *Trinity Pak* directly on top of center of head during daylight hours (6AM-6PM) for 3-5 minutes 2X day can afford quick pickup and balanced energy support. From 6PM-6AM placing the *Trinity Pak* on the 7th cervical area directly below back center of neck for 5 minutes, 2X during evening hours. For Women: Wearing as a pendant touching the skin in the thymus area or tucked into a bra cup. For Men: Secured with safety pin inside, mid center, back of trousers or under shorts if possible, touching the skin in small of back area.

The *Trinity Pak* contains three lithium compounds (Amblygonite, Pala Pink Tourmaline & Lepidolite) and three sodium compounds blended together in a specific ratio. These materials are in a 1-3/4" square lavender color fabric with gold stitching which resembles a little pillow.

\$10 each, plus \$2 shipping.

California residents add 6% tax.

BSRF, Box 429, Garberville CA 95440

A NOTE FROM THE EDITOR/DIRECTOR
As usual there was much more material than room for this edition, and only so many hours in the day. We are looking at ways to expand the size without incurring larger printing bills. We have received a number of books and tapes for review and they will appear in the next issue. A lot of excellent articles are lined up also. Thanks to all for your input and support. See you next issue!

Tom Brown

News from the Borderlands...

Volatile Vacuums. The February 1991 OMNI magazine has an interesting article on the awesome force contained in the vacuum. As can be expected from OMNI only establishment oriented work is mentioned. This article portends a revolutionary new technology based on Zero Point Energy — IN THE WORKS — but fails to mention any true pioneers of the energies and mysteries of the vacuum. Among the unmentioned: Philo T. Farnsworth II (who developed working nuclear fusion based on geometric arrangements of electron guns in a vacuum), Moray B. King (author of *Cohering the Zero Point Energy*) and Trevor James Constable (whose etheric weather modification units contain vacuum components.) The vacuum is the gateway to the ether, it contains many of the qualities supposed for the ether theories, but in an inverse sense. Definitely the main area of research for energy pioneers.

ARE WE RECEIVING BIOLOGICAL SIGNALS FROM OUTER SPACE? Article in the April 1991 *Popular Electronics* by L. George Lawrence, whose work in this area will be recalled by readers of *The Secret Life of Plants* by Tompkins & Bird. The answer is yes, earth is receiving curious biological signals and suggestions are given on how to pursue this research. Interesting that the pictures produced by these signals look amazingly like infrared photos of exobiological, atmospheric fauna taken by Trevor Constable in the late 1950s. (CR: Jorge Resines)

MYSTERY CLOUD ROLLS INTO TOWN.

An anomolous 6 foot by 6 foot "soapy, bubbly white cloud" rolled through Rose Creek, Arkansas. "It scared [the] geese so bad, they may never return." Whatever it was it disappeared when the sun hit it. Date and source not included with clipping. (CR: Robert Perelman)

POWER DOWN UNDER.

"Researchers in Australia have discovered the world's longest natural electrical current running deep beneath the vast outback. The arc is 3,700 miles long and ranges in width from 31 to 62 miles. It stretches from Broome, in the northwest, to the South Australian Desert, where it splits with one line hitting the south coast near Adelaide and another continuing northward to the Gulf of Carpentaria. The current isn't strong enough to be tapped for commercial power, but does run through all of Australia's major onshore oil and gas fields." Rather than being awestruck at this organized telluric energy flow "scientists" hope to use it to find more oil. Source: EARTHWEEK: A Diary of the Planet, March 15, 1991. (CR: Haroldine)

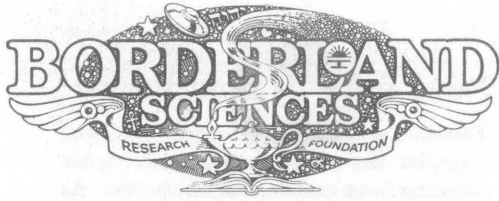

Bulk Rate
U.S. Postage
PAID
Redway CA
Permit 3

P.O. BOX 429 ★ GARBERVILLE, CA 95440-0429 ★ U.S.A.

**FORWARDING AND RETURN
POSTAGE GUARANTEED
ADDRESS CORRECTION REQUESTED**

BORDERLAND SCIENCES CONGRESS VIDEOS

Dr. Karl Maret: **SPIRITUAL SCIENTIFIC MEDICINE AND THE HEALING ARTS OF TOMORROW**

A major Renaissance of healing approaches. In this dynamic video, Dr. Maret merges his background in the creative and healing arts with an understanding of the anthroposophical principles of Rudolf Steiner to create a coherent illustration of the spiritual scientific principles that form the basis from which one may bring birth to a new humanity. With discussions of the subtle bodies, current advances in vortexian technology, and a full range of mind-expanding concepts. "By becoming attuned to the rhythm in all of life we will bring balance to each other". #V0019, 60 min, VHS **\$29.95**

Joan McKenna

THE AIDS AND SYPHILIS CONNECTION

Warning of the largest pandemic of Syphilis since the Middle Ages, this illuminating video offers startling and sobering documentation revealing the correlation between this age-old disease and the recent AIDS epidemic. And though the information presented is serious, Joan McKenna's natural charm and warmth make this tape thoroughly intriguing. Whether humorously exposing the misguided tenets of the Center for Disease Control or expounding on the seriousness of her findings, McKenna never fails to keep the viewer engaged. Through her work as Director of the Institute for Thermobaric Studies, McKenna and colleagues collected data from AIDS/ARC patients that showed Syphilis present in the historic profiles of too many patients to be ignored. #V0011, 60 min, VHS **\$29.95**

Donald Beans: **RADIONICS--MORPHIC RESONANCE AND SPECTRO-VIBRATORY PHYSICS**

In this vitally informative video Donald Beans introduces a new form of radionics in paradigm of light, color, and crystal energetics. Following Rupert Sheldrake's Morphic Resonance research, Beans, an acupuncturist and homeopath, has developed an innovative radionic tool in Spectro-Vibratory Imaging: the representation, on 35mm slide film, of the vibrational emanations of substances after they have been refracted into their spectral colors, and then using the slides as effective witnesses of the original substance. Donald demonstrates this exciting advance in radionic technique and proves that its application is limited only by the imagination of its human operator. #V0009, 60 min, VHS **\$29.95**

Larry Spring: **MY ELECTROMAGNETIC SPHERICAL THEORY**

Larry Spring's theory states that electromagnetic energy propagates in spherical energy units. In this video experiment he proves his theory and simply explains it for the layperson to understand. By placing chicken wire of varying sizes over a TV satellite dish, Larry is able to measure the size of different units of energy and determine their spherical shape. He also demonstrates that movement is important in the generation or use of electric fields and that the solidity of an object determines its reflectivity of signals. #V0023, 60 min, VHS **\$29.95**

Tom Brown: **ELEMENT AND ETHER**

Here is the grand view from the Borderlands brought to you by its adept director Tom Brown whose many years of research provides the basis of a compendious meditation that reconciles the question, "What is the Ether?". With illustrations of the elemental forms and Etheric forces ranging from ancient Tibet to modern scientific research, you too will be convinced of the Ether's existence after sharing this journey. #V0020, 60 min, VHS **\$29.95**

Alison Davidson:

WORKING OF THE STARS IN EARTHLY SUBSTANCE

It has been proven that the movements of the planets have a direct influence upon the earth and all living beings -- in particular the metals to which the planets were assigned in ancient times. Astrology and Alchemy are based on a real perceptible scientific basis, as this presentation will show. Researcher and writer Alison Davidson focuses on the phenomenal work of the German scientist Lilly Kolisko, whose 1000s of experiments using metallic salts display, without a doubt, the energies of the individual planets, as each leaves its characteristic pattern. #V0018, 60 min, VHS **\$29.95**

Buryl Payne: **DEMONSTRATION OF INSTRUMENT THAT DE- TECTS A NEW BIO-PHYSICAL FORCE**

Buryl Payne, psychologist, physicist, as well as designer and developer of the first commercial Bio-feedback instruments, recalls his discoveries during ten years of study into the bio-magnetic field. Finding a correlation between the earth's magnetic field and the body's magnetic field, Dr. Payne introduces some very interesting possibilities for the still little understood realm of magnetism. Demonstrating some of his experiments which require only usual household materials, Dr. Payne invites the viewer to try these experiments -- and to take them another step further. #V0008, 60 min, VHS **\$29.95**

POSTAGE & HANDLING: Add \$2.75/first, 75¢/additional. Californians add 6% sales tax
Write for a complete listing of 1990 Borderland Sciences Congress audio and video tapes.