

BORDERLANDS

A QUARTERLY JOURNAL OF BORDERLAND RESEARCH

SINCE 1945

Project HAARP

What is the Ionospheric
Research Instrument?

Breakthroughs in Home Healthcare

Tesla's Broadcast Power Pt. II

Astrology and Heredity

Detecting Biodynamic Signals



US \$6.95
CAN \$7.95
UK £4.50
NZ \$7.95
AUS \$7.95
JAPAN ¥695

Andrew Crosse's Agari

Page 32

The **Ray-X** Button™

Inexpensive relief from computer related fatigue

From VriiTek

Recent discoveries have provided a simple and cost effective means for eliminating the fatigue syndromes associated with exposure to computer monitors. These discoveries have led to the development of the **Ray-X** Button™. The **Ray-X** Button™ is constructed with a proprietary material which attracts, absorbs, and transforms monitor related emissions, rendering them innocuous to living systems. In simple experiments with plants, the **Ray-X** Button™ proved effective in the transformation of monitor emissions, leaving healthy plants, while test subjects without the **Ray-X** Button™ wilted and showed stunted growth (*Borderlands*, Vol. LII, No. 1, 1996). The **Ray-X** Button™ is THE cost effective way to eliminate monitor or television related fatigue, and produces results you can actually FEEL.

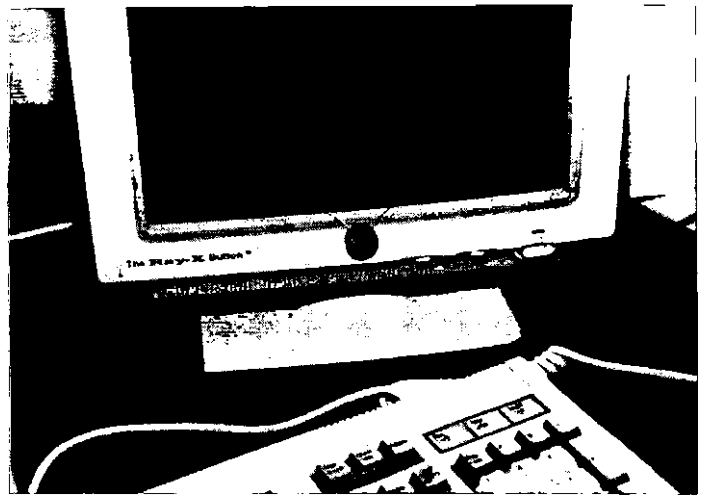

The **Ray-X** Button™ installs easily on almost all computer monitors and television sets.

Read what satisfied users say:

My husband bought a Ray-X Button for my computer 2 months ago. I was skeptical about the benefits but put it on my monitor anyway. Then, just in the past two weeks I realized that I have been working up to six hours a day at my computer. Before the "button", I could only manage a couple of hours before burning out. I'm convinced the noticeable effects are from the Ray-X Button.

— N. Simpson, Houston, Texas

Computers have always made me feel sick. Three hours use resulted in 3 days of "jet lag" and horrible eye strain, despite my glare screen. Since installing my Ray-X Button, I have no more fatigue and no more eye strain — in fact I have more energy!

— Judith Hill, Portland, Oregon

The **Ray-X** Button™ #E0025 ... **Only \$19.95**



The **Phon-X** Button™

The **Phon-X** Button™

Designed with the original Ray-X technology, and specially tuned to transform emissions from radio and cellular phones. Recent studies have shown the **Phon-X** Button™ to significantly reduce the fatigue associated with extended use of radio and cellular phones.

The **Phon-X** Button™ #E0027 ... **Only \$29.95**

The **Ray-X** Pendant™

Now the original Ray-X technology can be worn around the neck as a pendant. The pendant contains the original Ray-X formula, and is designed with a tuned open circuit ring, which was proven by Lakhovsky and others to beneficially transform a variety of noxious energies. This amazing technology actually dates back to the late 1920s, but is still as effective today!

The **Ray-X** Pendant™ #E0033 ... **Only \$29.95**



← Shown actual size

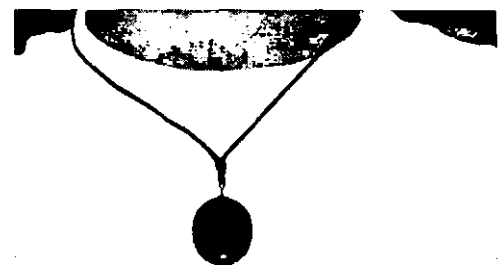

Send all orders to: Borderland Sciences Research Foundation

P.O. Box 220 ★ Bayside ★ California ★ 95524 Ph. 707-825-7733 Please include \$3 each for p&h.

BORDERLANDS

A QUARTERLY JOURNAL OF BORDERLAND RESEARCH

SINCE 1945

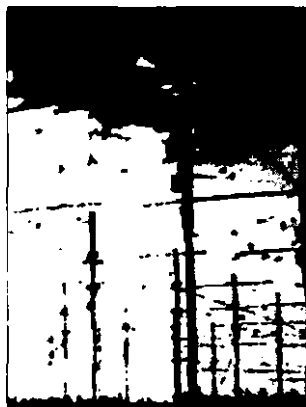

page 6

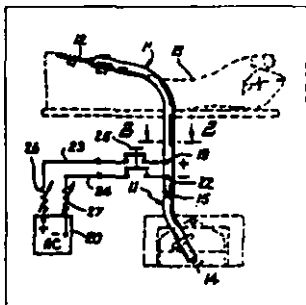

page 18

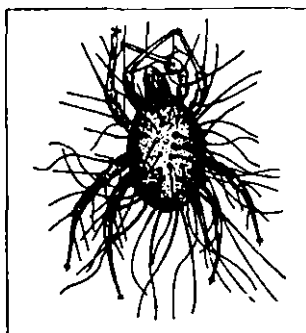

page 32

CONTENTS

FEATURES

HAARP WITH NO STRINGS:
WHAT IS THE IONOSPHERIC RESEARCH PROJECT?
Gerry Vassilatos 6

BREAKTHROUGHS IN HOME HEALTHCARE
Peter A. Lindemann 18

CROSSE'S ACARI
FROM THE BOOK: *ODDITIES – A BOOK OF UNEXPLAINED FACTS*
Lieut.-Commander Rupert T. Gould, R.N. (Ret.), 1928 32

ASTROLOGY AND HEREDITY – NEW EVIDENCE, NEW THOUGHTS
Judith A. Hill 35

DETECTING BIODYNAMIC SIGNALS, PART I
Michael Theroux 48

THE BROADCAST POWER OF NIKOLA TESLA, PART II
Gerry Vassilatos 53

COLUMNS

THE PUNDIT CURMUDGEON – PUNDIT CURMUDGEON VS. ARTHRITIS
E.D. O'Brian 58

THE BORDERLAND EXPERIMENTER: PLANTS AND RADIONIC CURRENTS
Charles Allon 26

DEPARTMENTS

EDITORIAL
Michael Theroux 2

CLIPS, QUOTES, & COMMENTS 3

Editor in Chief

Michael Theroux

Printing

TCI Press, Seekonk, MA

Production Assistants

Patrick Armstrong

Deva Lynn Morris

Brian Butler

Consulting Editors

Thomas Brown, Trevor James Constable,

Vincent Gaddis, Peter Lindemann,

Jorge Resines, Gerry Vassilatos

BORDERLANDS

A Quarterly Journal
of Borderland Research

BORDERLANDS is the quarterly research publication of Borderland Sciences Research Foundation. Contents © 1996 by BSRF, Inc. Individual articles are © 1996 by the authors. All Rights Reserved. No part of this book may be reproduced in any manner whatsoever without written permission from the publisher, except by writers who may quote brief passages to be reprinted for review or reference. Please write to the publisher concerning requests to make use of any of the materials published in this journal, or contact the authors directly.

Borderland Sciences Research Foundation, Inc. was founded by Meade Layne in 1945 for the purpose of investigating into realms normally beyond the range of basic human perception and physical measurement.

BORDERLANDS originated as Meade Layne's *Round Robin* in 1945 and was changed to *The Journal of Borderland Research* in 1959, finally becoming BORDERLANDS in 1992. BORDERLANDS is an information nexus for thinkers and doers on the frontiers of science and awareness.

BORDERLANDS is available by subscription for \$25 a year, worldwide. Single issue newstand price: \$6.95USD unless otherwise marked.

Subscription inquiries and address changes should be sent to our business office: BORDERLANDS, P.O. Box 220, Bayside, California 95524 USA. Phone: (707) 825-7733 or FAX: (707) 825-7779.

All article submissions and correspondence should be sent to: The Editor, BORDERLANDS, P. O. Box 220, Bayside, California 95524 USA.

For display or classified advertising write to the Advertising Manager at the above address for current rates.

BORDERLANDS can be reached on the Internet: <http://www.borderlands.com> - E-mail: info@borderlands.com

All published materials are presented for Informational and Research purposes only. Authors are solely responsible for the information and opinions they present. This material is not to be construed as expert opinion or medical advice, it is research into the Borderlands...

VIEW FROM THE BORDERLANDS

Editorial

WHILE considerable information relating to the project known as the High Frequency Active Auroral Research Program (HAARP) has been widely disseminated, we have refrained from featuring any articles on the subject until now. The reason for this is that we felt the need to research the subject more carefully before making any statements, and to present only the facts – without any of the extravagant speculations common to many other writers. Most of the wild claims concerning HAARP are to be found on the numerous web sites and discussion groups popping up on the Internet. It is our feeling that many of these groups and web sites have little of the facts, and are there mainly to propagate hysteria and unease regarding the HAARP project. We certainly do not condone or support HAARP, but our findings indicate that it is not what the conspiracy theorists have asserted. An essential requirement for a thorough understanding of what HAARP can and can't do is an exceptional knowledge of radio history – especially from the 1920s and 1930s. One cannot simply look at this relatively new project, and come to any grand conclusions without a prerequisite historical background in radio theory. Researcher and radio historian, Gerry Vassilatos, gives us his incredible insights into the reality behind the project known as HAARP – our first featured article on the subject. He has recently completed a thesis on the topic entitled, *Secrets of Cold War Technology - Project HAARP and Beyond* (see page 17) which contains many new and startling discoveries uncovered while researching the issue of HAARP. Mr. Vassilatos has concluded that there are unfortunately far more pernicious and sinister technologies already established which go beyond the restrictions of antiquated wave radio technology. There is no doubt that HAARP will continue to be a very controversial subject for some time.

Another very important subject covered in this issue is on the new breakthroughs in alternative home healthcare. Peter Lindemann treats us to his vast knowledge concerning this topic in one of the most informative articles ever to come into print. In very basic terms, Mr. Lindemann describes these new healthcare technologies from the researches of Hulda Clark, Robert (Bob) Beck, and Joel Wallach. Zappers, colloidal silver, "Pig Arthritis Formula", colloidal minerals, and other supplements are covered.

The works of Andrew Crosse are illustrated in a reprint of an article by Rupert Gould, author of the book series, *Oddities*. Here is an excellent source on the reproduction of Crosse's work with the galvanic generation of acari (microscopic mites).

Also featured are the exceptional articles "Astrological Heredity" by Judith Hill, Part 2 of the article, "Tesla's Broadcast Power", "Detecting Biodynamic Signals", and the usual columns, "The Borderland Experimenter" and "The Pundit Curmudgeon". We hope you enjoy.

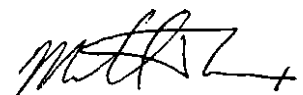

Michael Theroux
Editor

Clips, Quotes, & Comments

Earth Chi

I would like to see more detailed articles on dowsing such as Bill Cox's "Earth-Chi (Life Force) Energies in Motion" (*Borderlands*, 2nd Qtr. 1996). The qualitative aspects which he mentions within the yin-yang principle reminds me of the subtle energies detected by an acupuncturist when finding the proper needling point on the body.

There is a definite correlation between the Tai-Chi Symbols and the Orgonome presented by Wilhelm Reich. In Dr. Reich's experiments with dowsing he mentioned a qualitative interaction taking place between the energy source, the dowser, and the "divining rod". (He used a fresh wood "Y" stick). Reich inferred the idea of tuning into those subtle sensations simply as the "Pull" felt in the solar plexus when approaching an etheric energy source (like an OrAcc).

Dr. Samuel Sagan of Clairvision+School also advocates practice which leads to "sensing" earth lines and energy wells using only the body as a tool.

Even when using an extra tool like an aurameter one must ask where our sense organs end. Since the average radionic device relies heavily on "dowsing" with a stick plate to get precise measurements this may be a good example of unit and user becoming a union, therefore extending the human senses.

Bill Cox's thrust on disorganized Chi flow causing natural upheavals can be further extended: The basic structure of chi flow in the body is through the meridians and the chakras. Even if we sever a limb, this original energy matrix remains, but wildly tries to realign itself to the new physical form resulting in "ghost" pains.

The Earth is no different. The energy matrix of ley lines and dome centers must also wildly realign itself every time we mutilate her face.

Somehow the ancients knew how to correct this with Geomancy such as Feng Shui. In order to compensate the energy imbalance for whatever structures they would build, they would "needle" the earth with

dolmens, menhirs, pagodas, obelisks (like the Washington Monument), and sepulchres which are usually built over a spring when erecting a church.

These examples, and more, demonstrate how geomancy used to be a deep part of our lives. Perhaps, it could be again, considering the existence of some state acupuncture committees.

- R. F. Directo, Mountain View, CA

Coenzyme Q₁₀ Clarification

Dear Editor-in-Chief,

You are doing a mighty fine job since your taking upon the hard work task of *Borderlands* and wish to acknowledge.

Upon completing the excellent article "Homeopathy - the New Knowledge" (*Borderlands*, 2nd Qtr. 1996) by R.F. Directo, I felt it essential to write and add a list of clarification for readers. Coenzyme Q₁₀ (Co Q₁₀) is a natural substance found in every cell of a healthy human body. It was isolated and discovered in 1957. As research was continued, it was called the "miracle nutrient." Co Q₁₀ is available in health stores as a supplement. (An excellent book, *The Miracle Nutrient - Coenzyme Q₁₀* by E. G. Blizakov, M.D. and Gerald L. Hunt was published in 1987.)

The discovery of the 13th cell salt by Dr. Wm. L. Reimer, Ontario, Oregon, was in 1981, while working with the Golden C Crystal. Co Q₁₀ and the 13th cell salt appear to offer similar qualities for the body's well-being. Only when adequate bio-lithium is available within the body's cells, does transmutation occur that creates isotope Calcium₄₄ (Ca₄₄). This is a quality afforded by utilization of the 13th cell salt for the body's balance and well-being.

Further along in the article, Mr. Directo makes reference to Malcolm Rae and comments in the Lithium book. I have no recall to that reference and would appreciate enlightenment, if such reference was made.

Shalom,
Haroldine

Tesla's Broadcast Power

Very, very, very good Article on Tesla's "Broadcast Power" (*Borderlands*, 2nd Qtr. 1996) by Gerry Vassilatos! Tell him thanks for such a good review of Tesla's work on this. Very clear, and better than all the books on this - even by the Tesla Society. I have never read that his efforts were not using AC current - which appears most important - thanks to Gerry's explanation. I anxiously await Part II!

- James Miller, Coeur D'alene, ID

Infrasound Questions

I am writing to you for a couple of reasons. First of all, I want to commend you on an ever-improving publication. Not only is the content focused and professional, but the layout is equally as attractive. Believe it or not, the "look" of a magazine ignites the interest of new readers. Secondly, I have a comment/question regarding "Infrasound" (*Borderlands*, 2nd Qtr. 1996). I found the subject interesting because of the widespread involvement that infrasound has with a plethora of natural phenomena. I encountered a similar, if not the same, subject when studying statics in college physics - namely the resulting destructive power exerted on man-made structures due to natural resonance. The thing that comes to mind is the now-famous embarrassment to modern engineering that occurred with the Tacoma Narrows Bridge a few decades ago. The violent waving action of the bridge, believed to be an effect of the high winds pouring through the straits, had been going on for some time before the bridge literally shattered. The prolonged activity allowed for engineers and technicians to observe and even film the disastrous demise of the bridge. The violent finale resulted in the death of an innocent bystander, namely the pet dog of the observing engineer on duty at the time. Now, my comment/question regarding infrasound has some context. Could you possibly form some links between the destructive result of a man-made structure vibrating at its natural frequency and infrasound, if there are any. More specifically, is the destruction of the bridge a result of some infrasonic phenomenon, is there an infrasonic effect due to the resonant frequency of the bridge at that time, or is there merely a loose correlation between infrasound and the wind activity and/or the

CIRCULAR TIMES



WHAT IT IS!

AN INTERNATIONAL
NETWORKING EDUCATIONAL
FORUM ON PROGRESSIVE
INTELLECTUAL STUDIES

*Archaeology, Sacred Geometry,
Vibratory Physics, Mars, Egypt, UFOs,
Crop Circles, Sacred Sites, Astronomy,
Alternative Energy & MORE*

CONTRIBUTING EDITORS:

Robert Bauval, Dr. Mark Carlotto,
John Anthony West, Dr. Colette M.
Dowell, Erol O. Torun, Prof. Gerald S.
Hawkins, Prof. Stan McDaniel, Linda
M. Howe, and many other award
winning researchers of the anomalous.

CIRCULAR TIMES

A QUARTERLY PUBLICATION

Annual subscriptions:

\$24.00 US / \$32 Foreign

sample issue \$6.95 US / \$9 Foreign

Send checks payable to:

MOVING FORWARD

30 Sunny Grove Road

Nebo, North Carolina, 28761

704-659-9167

704-659-8640 FAX

email: cmdowell36@aol.com

A Moving Forward Publication



INTRADIMENSIONAL COMMUNICATIONS &
TIME travel tech. manuals. Incredible in-
quiry catalog (stamps) Box 2207 tt. Gar-
den Valley ID 83622

resonance of the structure? As I am not an expert in the field of engineering or physics, and since it has been several years, to say the least, since I was in college, I hope that my question is not confusing. One last comment that may be helpful to me and other readers is that I noticed that the article had no endnotes, footnotes, or references. Could you honor my last request for a pointing in the right direction, so that I may follow up on this subject myself? Perhaps I should have simply asked that and only that question to begin with. Anyway, I appreciate your response.

- Alan Welles, Louisville, KY

Thanks for your letter. We think the infrasound phenomenon is especially interesting in relationship to the strange subsonic "hums" that have been heard in several locations across the country. Probably the most famous is the Taos Hum (we hope to feature an article on this and related phenomena soon) which has its own discussion group on the Internet. I would suggest a search on the Internet for any answers to your questions as this is a subject that seems to possess little research material. As for the destructive nature of infrasounds on man-made structures, a forthcoming article in Borderlands on the infrasonic weapons research of Vladimir Gavreau should lend some answers.

Keep those letters, photos, and clippings coming! Please write to Borderlands CQC, P.O. Box 220, Bayside, California, 95524 USA. Letters may be edited for length and clarity.

ADVENTURES UNLIMITED

Exploring frontiers in:
•Travel •Science
•Archaeology •History



Inside our FREE catalog:
Ancient Wisdom, Conspiracy,
Lost Cities, Exotic Travel, Tesla Technology, UFOs,
Free Energy Science, Anti-Gravity, and more!

Call/Write/Fax
ADVENTURES UNLIMITED
303 Main Street • P.O. Box 74
Kempton, Illinois, USA 60946
Tel.: 815-253-6390 • Fax 815-253-6300

Scientific Alternatives in Health Exist Now!

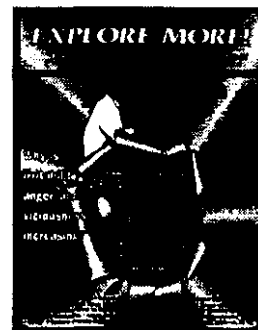

Learn about the latest
research from around the world
in the field of medicine.

- Effective treatments for cancer, AIDS, and other degenerative diseases
- The latest in Homeopathy, Energy Medicine and physics

You cannot find this range of
reliable knowledge anywhere else.

For subscription information
call or write today:

Explore! Publications

P.O. Box 1508, Mt. Vernon, WA 98273

Telephone: 360•424•6025

Fax: 360•424•6029

E-Mail: ExplorePub@aol.com

Major Credit Cards Accepted:
1•800•845•7866 (orders only)

Sample issues available:

U.S., \$3.00 per magazine (postage)
Int'l, \$5.25 per magazine (postage)



On the cutting edge
of the future.



SIR WILLIAM CROOKES'

Radiometer

Referred to by Dr. Nikola Tesla as "the most beautiful invention ever made", the RADIOMETER is an endless fascination. Sir William Crookes, inventor of high vacuum cathode ray globes, created this marvelous motor in order to prove that light pressure could move matter. Called "light mills" by our Victorian elders, the greatest surprise came when the double coated vanes moved in the opposite direction! The RADIOMETER spins on cold, dark cloudy days almost as well as it does in full sunlight! Make your own new discoveries with the "jewel of motors".

Radiometer, #E0028 ... **Only \$8.95**

The Original Cameron Aurameter

Dowsing Instrument

The Cameron Aurameter, is considered the "world's most sensitive dowsing instrument". It was developed over a 22 year period by the late dowsing Master, Verne L. Cameron. With it, you can outline the human aura, or locate underground water sources. Used with patience and without prejudice, this instrument will give you amazing results. With practice, it will help to open up wonderful and unknown natural laws and forces to you.

Chrome-plated Aurameter, #E0005 ... **\$79.00**

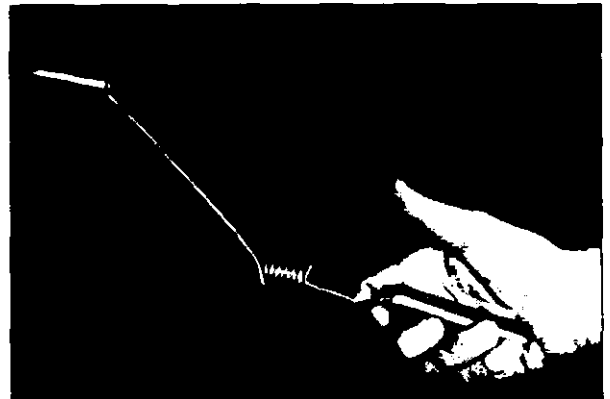

Penergizer

Commercially delivered water, through the process of chlorination, fluoridation, and pressurization, has lost most, if not all, of the natural living energies which the water originally contained. Johann Grander, an Austrian inventor and naturalist, has developed a method of re-vitalizing water to this original "living" condition. The method Grander has developed utilizes the concepts of magnetism, Hahneman's potentization, and Shaugberger's Implosion, to restore water to its original state of vitality and health. This technique, which Grander has termed "Wasserbelebung" or Water Revitalization, is the central active factor involved in the function of the Penergizer. The Penergizer is a pocket-sized instrument which allows anyone to quickly and easily re-vitalize water. Great for travelers.

Penergizer, #E0032 ... **\$119.95**

New!

Ba-gua Mirror

Feng shui — wind and water, *the art of adapting the residence of the living to harmonize with the cosmic breath* — this ancient Chinese art possessed various objects to remedy geomantic defects. The *Ba-gua*, or Feng shui mirror is one of these objects which can be used to deflect *sha qi*, or "breath of ill fortune". Placed over your front door, or inside the home at strategic locations, the Ba-gua will redirect negative energies away from living areas. The Ba-gua is constructed from wood with a small circular mirror in the center and is painted green and red with gold trigrams. **Ba-gua Mirror, #E0031 ... \$6.95**

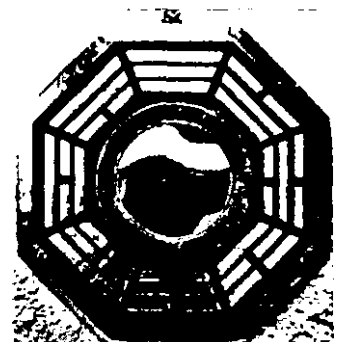

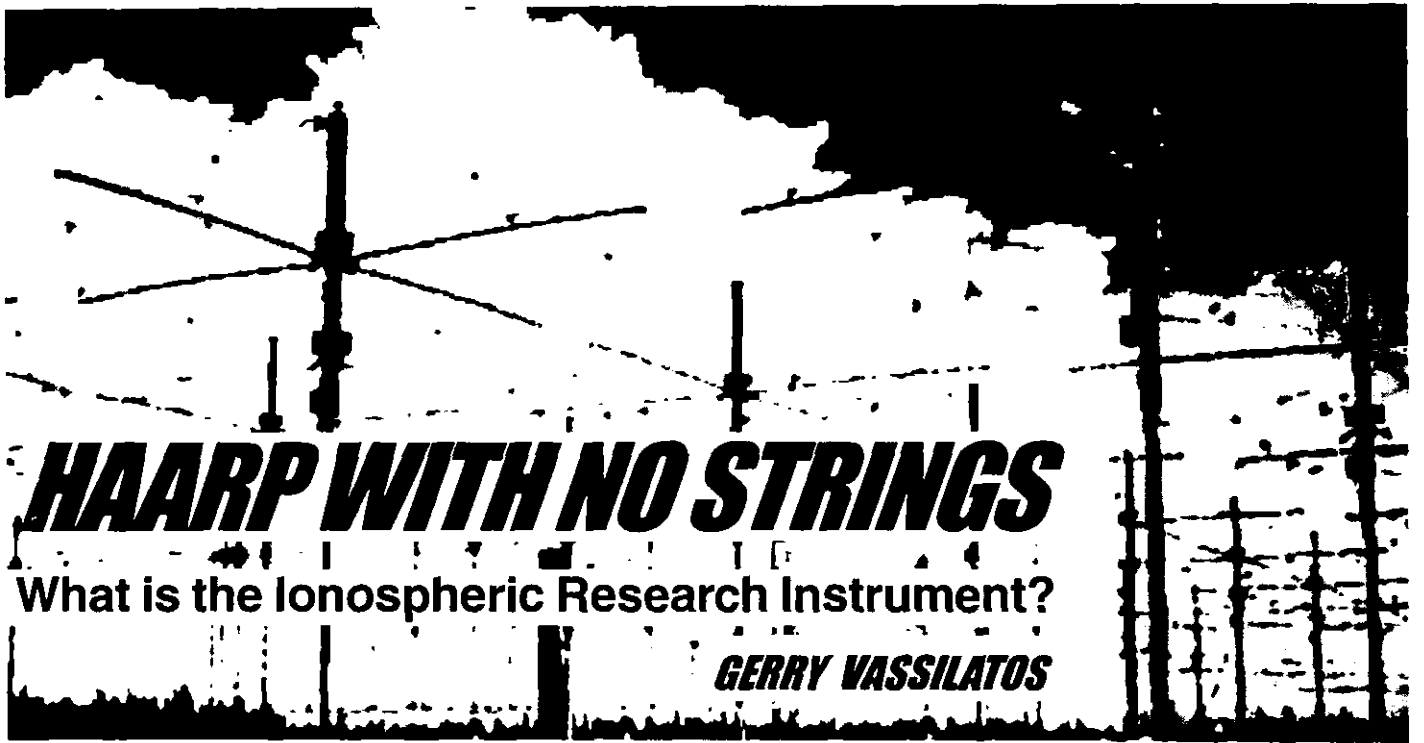

HAARP WITH NO STRINGS

What is the Ionospheric Research Instrument?

GERRY VASSILATOS

MUCH concern has recently been focussed upon the military project known as HAARP, a technological monstrosity which for some researchers seemingly resists all serious attempts at analyzing its true purpose. By its many morbid conspiratorial devotees, HAARP has been called the very apex of Twentieth Century military technology. Familiarity with technologies such as HAARP does not mean a simple survey of available conspiracy type publications. The recent release of military statements, largely disseminated to intellectual curiosity seekers through the INTERNET, is a thorough and full disclosure of the technology. Of course, one will read through these with a watchful eye. Nevertheless, the HAARP photographs reveal a startling and contradictory evidence to statements which habitually surround the topic. HAARP is a secret project, but it has nothing to do with those applications recently described in a popular bestseller. While discussing aspects of the scientific hardware, which have not to my knowledge been elucidated, my single most important theme focuses attention upon the deeply entrenched directives ruling the financial world.

Incomplete understanding has provoked such degrees of fear that many name HAARP as the very tool by which the world will be destroyed. Excessive sentiments of this kind evidence a growing hopelessness. Amid a world filled with the curious apathy which closely shadows affluence, there exist those whose only joy is found in morbid inspections of doom. Retrospective study reveals that previous episodes of the tumultuous Twentieth Century have released similar openly fearful expressions. Each new technological expression has had its attendant commentary of doom. The recent proliferation of fear and hysteria is perhaps the externalization of so many internal conflicts

seeking expression. It is peculiar that, in so many similar historic episodes, fear of doom attaches itself so readily and so deceptively on the works of technology rather than on their true source. Technology is the projection of deeper principles. As regards the negative aspects of human consciousness, it is always easier to point blame at something external.

A populace whose innermost awarenesses are just being aroused to seek personal meaning comprise a formidable host. A society whose government has so striven to remove the natural drive for personal expression is now confronted with an army of citizens who operate in the intellectual spheres. The civilian recognizes why government actions are so ruthless. Those who dictate government policies are not politicians at all, they are old dynastic personalities. The super-privileged rule the land, government obeys their dictations to the stroke. Military is employed to enforce the commands which the money holders demand. Civilians become victims of merciless military actions when the truth is out. It is important for us to understand the restructured nature of our republic. Having been suborned to operate as a bureaucracy for the dictates of a few, we have been prevented from realizing the natural development of discovery and wonder, the providential gifts. Those who enjoy super-privilege do so only at the expense of the entire populace. The dream of one or two becomes the servitude of one or two hundred million.

ANSWERS

How proficient are the writers of conspiracy themes? Hysteria is the chaos of ignorance. HAARP and its other brethren projects are not recent developments. They are the most recent representatives in a research effort whose history stretches out

before the last Century. Before we presume to dissect and interpret HAARP, we require historical familiarity with the documented hardware, phenomena, and original rationale for the deployment of these projects. Containing statements and opinions which are mutually contradictory, technical conspiracy books are never the scientific reports which they so profess. They are hastily written, poorly organized, insufficiently researched, thematically underdeveloped, and consistently overpriced.

As a novel means for supplying any and every possible answer for a price, conspiracy writers have directed a new publications initiative. The typical conspiracy writer supplies an insufficient emollient to a painful social wound. People who ask questions want real answers. The confusion of fragmented facts presented in such publications does satisfy those whose innermost need is contextual meaning. The unfortunate absence of such concise presentations becomes the lucrative potential of the new genre, as conspiracy writers keep their over-inflated texts moving through distributors.

One reads through several examples of these texts with a sense of growing amusement. Each new example verifies the often repeated observation that such books are made to be sold, not to convey facts. Filled as they are with turbid convolutions and nightmarish scenarios, this new publications assault has succeeded only in promoting a confused consciousness of concern. The factual fragments comprising conspiracy books, cassettes, or videos are designed to bait the reader into forming personal conclusions. These almost invariably satisfy the personal needs of readers who are actively seeking a conspiracy. The writers of these books carry no burden of proof. Theirs is the role of provocateur, irresponsible activators and promoters of social malaise without solution.

We are the unwitting witnesses of a rare manifestation which has not made its appearance since the period following World War II. Of the hysteria which has worked its way throughout our contemporary society, no undercurrents seem more energized than those which find nightmarish delight in uncovering the possible "monsters in the machines". The deeper implications of these abnormal sublimations stir thoughts of the destructive principle in human consciousness, that which delights in seeking horrors. But what would so invert the normal life-seeking drives in social consciousness? The answer to this penetrating question exposes the workings of human consciousness both in alienating and being alienated. The principle which has no regard for human life is familiar to working class people alone.

DIVORCE

Those who very clearly sense the divorce between military and citizenry know that military intentions do not include the best interest of the citizen. Alienation, separation, rejection, divorcement. These are the real foundations from which social fears emerge. The social fears remain latent, mere undercurrents and suspicions seeking a focal point. Distrust finds its vent when authority demonstrates its adamant rejection of extraordinary citizens. Technology often becomes the rip in the walls between

social Id and social conscience. The instability through which suspicion becomes conspiratorial hysteria can be the slightest imposture or gesture on the part of an authority figure. When once society has suspected its government, the hysteria rages in full.

Are there reasonable sources of social anger in this regard? The arrogant and often hostile separation existing between government, military, and civilian sectors is forever brushed aside as "the preservation of national security". Maintaining certain secrets from the populace is a token not well received by an intellectual population. In this continual removal of knowledge from a supposed liberated society, government is demonstrating broken trust. Here we find the origins of social suspicion. When a military organization necessarily requires secrecy, personal alienations magnify the latent social fears. Nevertheless, it is hilarious to discover what government agencies consider to be threatening secrets. One perusal of the patent collection will prove this to anyone.

SECRETS

Can we penetrate the secrecy? Can we indeed find answers to the HAARP "problem"? There are no secrets. Technological history is replete with instances of multiple simultaneous discoveries. The intelligence networks run over one another. Publications are instantaneous. But this statement does not refer to electronic mail. The history of science proves that ideas literally flow through space. Similar intense minds successfully communicate at unfathomable deep levels. What is learned in one laboratory soon appears spontaneously in many others. Study the literature and see this phenomenon repeated countless times. In this continual manifestation of intellectual fusion, only the sensitives have value. Those who demand and those who direct are helpless observers of processes which reveal the true heart of humanity. Those who exacerbate separations among societies are only forestalling their own obsolescence. In truth, there are no restrictions, no boundaries to the flow of such consciousness. Secrets cannot be kept. One can no more control the avalanche developments of technology than one can control the ocean. The absence of total secrecy is perhaps then the greatest secret.

Even the military projects which have so powerfully focussed the writers of conspiracy essays have recently begun to "make utterance". The recent release of "full disclosures" by the military is an equally curious modern manifestation. The great furor which HAARP has released has been successful enough to force military statements. One now finds that the military itself is declassifying patents and articles pertinent to the HAARP Project, an unprecedented willingness to quench the social spotlights which they have drawn. Why are they so willing in this opened disclosure policy? What are they trying to protect? And on whose behalf are they making these apologetic campaigns? Does the disclosure of hard data signal both the obsolescence of that data and the possession of superior technology?

GAMES

The superficial world game is a vain exercise of Control itself, of Regulation. The controllers wish to maintain their poise and power over the populace. This is nothing new. Rome saw endless such struggles, and is no more. There are those who comprehend evidence of deliberate design in the adamant and ludicrous behavior of military against citizenry. One asks the motive behind such a poise. What agent is capable of demanding and establishing such a rift? There are but two principalities which rule the workings of the world. Of the nation. Control and Money. Domination, rule. Extending the permeating alienation which has so thoroughly characterized our time, one will always find grasping hands of greed at work.

Excessive control, excessive regulation indicates a demise of social integrity which no military might, however fascistic and demanding, can alter or change. Ideas remain. Ideas and Ideals. They are visitors, messages from a deeper reality. American Military has traditionally overestimated its own worth and misperceived its role. In truth, military is the workhorse of the Multinationals and nothing more. It is certainly not the right hand of Liberty with which the poster propagandist campaigns puts forth. Military has been, and will remain nothing more than the strong arm of American Big Business. Secret military projects do not begin in the military at all. Secret military projects begin in the boardrooms of the business world. These are the origins of the covert. Here we find those who would control our destinies and those of our children for generations. Having developed systems for controlling the systems, multinationals rule by the scratch of a penstroke. Money threatens depression, and the Laws legally fulfill the intent.

Business rules science and industry. Business rules military. Business rules government. One protocol rules all the others. Civilians find themselves under the most direct authorities, above which there exists a gantry of superior commanders. Imperialistic designs desire the acquisition of foreign resources. Outright war is politically impossible unless reasonably overt excuses exist. In the absence of these, conditions must be created. Central Intelligence "stimulate" numerous controlled circumstances. These are contrived to divert attention away from certain activities. Study the patterns whereby hollow regimes appear in resource-bordering nations. The threat of war is suddenly reported. Some new dictator has "risen to power", the latest in a series of synthetic madmen. The president is concerned, and the Senate votes unanimously. Military forces swoop in, and presto! Nightly News reports a new victory for American troops. Props and setups all. The realistic result of these imperialistic ventures is that citizens pay for the expended weapons, while Big Business acquires a copper mine, an oil field, a uranium supply.

My advice to conspiracy writers is this: do your research better. Find out what resources every US occupied nation contains. And who did the dirty work? Military. But Military initiates nothing. Business initiates. Military is merely an effective and dictatorial agency for driving and directing otherwise

disoriented academic researchers toward the achievement of realistic goals. When Business wants a job done, Military researchers devise means for achieving those goals. Military force executes commands which begin in private liaisons among bankers. Military "advisement" simply insures that research goals are achieved within the prerequisite time period. Those who accuse the Military of engaging in covert operations know nothing of the fundamental facts concerning a subject of which they claim such superior insight. Military takes its orders from the cliched frail white business men in brown round toed shoes, whose dispassionate gazes smack of old American families.

MODUS OPERANDI

Historic examination of American policies reveals that the demands of a very few cartels consistently direct these superior commands. Manipulative control of military supremacy has continually achieved the questionable personal ends of the few. Keeping ahead of one's adversaries gives technology the notion that government loves science. The lie is total. Cartels want those uranium mines in Africa, so military gets the funding to develop all sorts of new death devices for "testing". But do not be deceived, throughout the process we observe that military is not in the position of initiation.

The military does not engage in such projects unless under superior command. The pure love of science or the pleasure of acquiring scientific data is not in their command-obedient agenda. For the military to desist from the study and development of new weaponry, a superior command of exceedingly high priority must be in effect. Military does nothing on its own, and cannot. After the governments themselves bow in homage to superior capital, military is the slave of cartels. Business directs. Business gives the orders. The Government issues commands. The military executes.

When the battle smoke clears, medals are clipped on old Generals and Big Business lights up cigars all around the boardroom table where it all began. To achieve the various objectives which business demands, ever newer "measures and countermeasures" have been steadily developed since the Cold War. Non-nuclear weapons packages and other cunning technologies have continually facilitated various deceptions, conditions, and terminations which ordinary citizens fail to recognize as deliberate military actions. In brief, the military is well stocked with a reserve of surprising weapons and communications systems which enable the rapid acquisition of foreign resources when commanded.

We must also look behind the imperialistic forays in order to comprehend the rationale for the numerous little military exercises which have so colorfully flooded our television screens for the past thirty years. The desire for foreign resources is no blind ambition. The desire for foreign resources is always predicated on the demands of new ventures. Wars are fought on many battlefronts. The most decisive wars are fought in study, where new ideas emerge. A single idea can alter the course of centuries. And none know when or where such an event may occur. While



All photos from The HAARP Web Site at:
<http://server5550.itd.nrl.navy.mil/projects/haarp/haarpIndex.html>

This is the Developmental Prototype of the HAARP Ionospheric Research Instrument. It consists of 48 antenna elements arranged as 8 rows by 6 columns. Construction of the antenna array was completed in November 1994. The array is being used to evaluate the engineering design for the HAARP IRI. Initial testing of the Developmental Prototype began in December 1994 and has occurred intermittently since that time.

the private military laboratories burst with unsuspected new technologies, monies for these "projects" arrive in unending rivers from demanding multinational bankers.

Cartels employ active research staffs to scope the science world for potentially destabilizing expressions and designs. While unable to stop the progressive emergence of such inspirations, they can and do manage the efficient eradication of perceived threats. Scholars and patent bibliographers well know that working technologies, now well beyond their third stage of development, have already rendered the much-discussed "covert" military technologies obsolescent. No single statement can be more important than this one. In rarely mentioned reports, military research successfully developed sophisticated raybeam systems which exceed the optical laser in coherent penetrability and lethal power.

NASA, as a military adjunct organization, has continually enabled and maintained deployment of a worldwide military satellite exchange. The heavy schedule of NASA Space Shuttle launches evidenced the deployment of highly secretive military packages in predetermined orbits throughout its decade long history. These systems have replaced radiowave technology in both communications and reconnaissance operations. Coupled with space technologies, these optical and paraoptical technologies now best represent the true and classified military state of the art. For this reason it is strongly believed that ELF projects such as SEAFARER will shortly be decommissioned. Radiowave technology has been rendered obsolescent by better and more dependable technologies, the nature of which has never been discussed in the open. I have retrieved the patents which prove

my assertions.

In this confusion is discovered the inestimable value of conspiracy writers to military security. Declassified military patents signal the deploying of complete highly advanced systems. Military declassification is a diversion for the intellectuals who are easily fascinated by technological baubles. Remember, the modus operandi are completely opposed. The military is not intrigued or concerned with the wonders of nature! But why was the military so absolutely empowered to develop superweapons at all? Both during and after World War II, certain multinationals sought security in trade. Capitalistic security. For this reason alone, Allied military was given the wherewithal to develop weaponry. When Japan threatened Pacific free trade, an invincible weapon was sought. Funds for the Manhattan Project did not come from the American taxpayer. The Government was already in debt to the Federal Bank lenders. Cash flow for this weaponry came from privateers. The Atomic Energy Commission managed the ancillary Industry on behalf of the original investors. This conglomerate is also reaching its logical conclusion, a startling outcome which we will shortly discuss. Nevertheless, the many levels in which multinational organizations seemingly coexist reveals

that they themselves are in devious competitions.

Many continually cite Communism as the trigger for the rapid proliferation of nuclear stockpiles. Communism only threatened capitalists who were themselves divorced from the innermost circles of multinational business. Communism was not an accidental revolution. Neither was it an economic "experiment", as some have suggested. Communism was a business weapon, aimed at those who were not invested. Communism was a privately owned system which used the totalitarian government as a permanent deterrent to all other potential investors. The central mystery figure in this high level domination was Armand Hamer, whose continual private inspections of both Soviet Government and Industry are unquestionably financial. Hamer reaped unmentionable capital profits from Soviet Industries, while consorting with Allied cartels.

World business is a game of simple causes and effects. The only variables are those which technology brings into the game. Besides these new variables, human nature and human reactions remain unaltered throughout history. "Outsider" cartels recognized the inherent weakness in the otherwise dominating stronghold which Hamer had devised and executed. Fixed in a political arena, it was possible to threaten that fortress with the new weaponry. The mere suggestion that outsiders could destroy the totalitarian "arrangement" would perhaps sufficiently serve to bring Hamer into dialogue. Hamer himself was the only individual permitted to enter Moscow airspace without question. Met by personal limousine, Hamer was secretly escorted to his Russian estate, a huge property maintained in his absence by a privately hired workforce. When he so desired, Soviet military

brass and the Premier himself would arrive at the estate. Clearly, from its inception Hamer was underwriting the Soviet regime.

Toward breaking this strategy of domination, the numerous outsider cartels directed the unprecedented deployment of atomic weaponry. When the initial threat was matched with a Soviet duplicate of atomic weaponry, the game was locked in "cheque". Seeing that this maneuver did not succeed in bringing Hamer to the consortium, the AEC was directed toward developing more powerful weaponry. Thermonuclear devices were the frightening result, an unexpected and horrifying outcome of the unleashed scientific consortium. There being no theoretical limit to the effective destructive extent of such weaponry, the development and deployment of novel weapons became a prime objective throughout the "Cold War". In the face of "Mutual Assured Destruction" scenarios, priority was eventually revised in the development of tactical weapons which permitted post-war occupation. Neutron bombs were tested to satisfaction during this time period, a small spinoff of patented devices whose descriptions have been recently unearthed.

RUMORS

The unfortunate mention of a few misunderstood military technologies has flooded society with conspiratorial issues, suspicions and rumors having no real foundation. In such a fear-ruled atmosphere there can be no true objectivity, no serious scientific discussion. In order to allay the fundamental fears which have been incited by all too numerous and over enthused writers, this article on HAARP has been composed. What we require is factual clarification.

Patent retrieval requires historical scope, otherwise an over-excited response will produce convoluted misinterpretations. This is precisely what has happened in discussing HAARP. Therefore, a brief summary of military achievements in the high-tech realm may be fitting. The largescale demonstrations of plutonium and hydrogen bombs brought the discovery of a new and unexpected phenomenon. Electromagnetic Pulse, or EMP phenomena, became the focal point of intense military interest. Remember who was directing the military progress in these endeavors. Though we have deep interests in the natural phenomena which attended such experimentation, please recall the patronage behind these tests.

The EMP phenomenon suggested a new weapons potential which could be used in a limited strike scenario. The technique would not require large yield nuclear weapons, and seemed a plausible route to pursue. Stimulating a powerful and decisively destructive EMP across any military opposition, EMP's reaching several thousand amperes were powerful and penetrating enough to burn out electronics packages and power grids in a single instant. EMP potentials were derived from ground induced ring currents beneath the rising plasma of any small nuclear blast. The essential feature was that EMP's could not be blocked. In this, military recognized a new weaponry.

Military researchers quickly developed controlled EMP devices and techniques throughout the years between 1960 and

1970, the details of which are given in my forthcoming book (*Secrets of Cold War Technology - Project Haarp and Beyond*.— see ad on page 17) Special techniques for enhancing EMP action were investigated. Military deployed new non-nuclear devices in identical research themes, dispersing ionizable chemicals through high aerial detonations. Experiments performed with these artificial plasma clouds were designed to test a variety of weapons objectives. These techniques were discarded with the development and deployment of satellites, ineffective "over the horizon" and other such "back-scatter" RADAR techniques being replaced by optical reconnaissance.

Discovering that aerial plasma clouds could destroy short-wave reception for hours and days if necessary, military experimenters experimented with ionospheric "heaters" for a time. These were found capable of delivering controlled shortwave blackouts for sustained periods. Military frowned upon the monstrous station required in supporting such techniques. As weapons, their excessive expense and size rendered them easy "first strike" targets. These too fell into obsolescent disuse with the deployment of several satellite deployed beam weapons. During the SDI period, military was given command to launch weapons-ready orbital platforms, and deployed surveillance and reconnaissance satellites in a continual volley of private missile launches.

Please recognize that the technical bibliographic reservoir gives us the only reasonable basis for assessing and evaluating projects such as HAARP. Technological developments of this magnitude are attended by a great host of research reports and ancillary experimental proceedings. Historically released publications represent those thousands who have had empirical knowledge of real equipment. The difficulty of tampering with such a densified bibliography is inestimable. Deliberate eradication of such bibliographies by intelligence agencies has never been completely successful, the indolence and relative apathy of the populace being a dependable enough deterrent to possible security leaks.

No single intelligence agency can exercise manipulations to the degree that every single report may be altered or eradicated. Freedom of expression rules in the older bibliographies, provided you are able to yet obtain them at all. It is through the bibliographic manifold of visionary tunnels that the astute analyst discerns the razor edge of truth. In addition, the examination of numerous military funded technical reports always places the private analyst on alert. Those agencies who prepare and publish their official reports are as dubious as those who compile conspiracy theories. And writers who doubt both groups are held opened to the very same accusations! Seeking the balance, one strikes a curious pose. Tethered on a jeweled pivot between military releases and conspiracy theories, one seeks a clear image of sunlight in a hall of mirrors. But one fact is clear and remains. All publications serve as markers ad points on which we may focus discussion. In this, we have a lever which can indeed move the world of secrecy.

Having anticipated the social turbulence which surrounds

projects such as HAARP, military journalists have been hard at work carefully selecting certain hard technical data for publication. Hundreds of declassified pages have been dispatched through the INTERNET. It is a simple and effective means for powerfully silencing potentially irascible intellectuals. Curiously, it is the military who are again in position to step in and act as the "voice of reason". Yes, amid the oceans of fear and suspicion which highly classified projects have stimulated, the military is itself emerging as the very epitome of honesty and beneficent authority. The military prose writers have succeeded in using the social paranoia which they themselves have triggered to their own best advantage.

But the real direction toward which military advisement has progressed is no hideous covert plot to mind-manipulate the nation. What lies at the root of HAARP is a mundane business arrangement which the all too elaborate paranoia has typically and completely misinterpreted. The great and monstrous fear which has been evoked among the intellectuals actually centers around a business foray which the military has been commanded to develop by executive command. It is therefore in this light that we will unravel the HAARP issue. What conspiratorialists so fear and suspect is delusional. Hysteria is not the atmosphere proper to the deliberation and extrication of facts. Hysteria blocks the pursuit of clear thinking. HAARP is about Power, Control, and Money. Nothing more. One must break through the fear which conspiratorialists are weaving. Get the facts.

EASTLUND

Why have discussions on HAARP become so redundant and convoluted that the entire discussion has been rendered incomprehensible? The writers of sensational conspiracy books have very ignorantly admixed a great number of completely unrelated patents together. The basic assumption that all of these separate and distinct patents have been combined to form HAARP began as the erroneous conception of a single researcher.

Pulsed RADAR, Beam Weapons, ELF, Subsurface Tomography, over the horizon RADAR, Gamma Ray detectors...only a complete incompetent would ever assume that these patents are vaguely related. Further idiocy is required to believe that any single system could deliver such a menagerie of potentials. Even P. T. Barnum would have blushed before presenting such an outlandish set of promises. The fact that certain writers of the conspiracy camp have so admixed these indicates the degree to which the absurdity has been expanded. HAARP has nothing to do with any of the conspiratorial topics whatsoever, as a precursory examination of the photographic evidence should teach. What is required of scholars entails a proper and thorough classification of each of the distinct patents relevant to HAARP. Unfortunately we do not have the entire series of patents which have been collected and collated in these regards, so we can never agree with those who claim to have done so. But I have found better than the patents which support the HAARP thesis which so many acclaim. I have found patents

which prove that HAARP cannot possibly be any kind of weapon, a diagnostic device, a surveillance system, or a superior communications technology.

Look at the photographs. Examine the evidence before your eyes. None of the cited patents on various radar systems apply here at all. Look at the array! See what is before your eyes. Radar heaters? HAARP does not include such features. There are no SHF structures anywhere in sight. Eliminate the hysteria, block out the conspiratorial noise which blinds your eyes. What do you see? Perhaps you do not see because the writers of the more hysterical accounts concerning HAARP, symbolists and storytellers of the subconscious, have no real information to share. One needs an historical, not an hysterical continuity to gain the single overwhelming evidence concerning the IRI. Competent technical libraries contain much of the data which precedes each of the separate radiotechnologies. The bibliography dealing with radio technology is replete with examples of projects like HAARP. Indeed, one finds a bibliography so well documented that to make such otherwise blundering commentary bewilders the imagination. This HAARP has no strings.

Most of the systems relevant toward gaining such understanding were developed prior to World War II. Projects exactly like HAARP have already been established and discarded before 1930! Texts on EMP, ELF, and RADAR flood the technical shelves. The information, opened and declassified, is waiting to be read. I have recently finalized an immense file on such topics as to completely revolutionize all serious subsequent discussion on HAARP and other secret technologies. This file will comprise a second, more technically oriented publication on topics which reach far beyond HAARP.

Critical comprehension of HAARP does not require examination of the Eastlund patents. That supposed base on which Project HAARP was framed has little to do with the actual device in Gakona, Alaska. The Eastlund patents present such a confusing assortment of components and proposals that serious scholars are immediately suspicious. The device demanded by Dr. Eastlund boasts several completely contradictory applications. One reads that the fully operational system will "modify weather patterns...derange incoming missiles...focus sunlight on distant areas...lift enormous sections of atmosphere to unprecedented heights...create strong updrafts...evacuate atmospheric regions...target specific locales to produce drought...stimulate ELF signals in the Schumann natural waveguide...a duplication of Tesla techniques".

By this description, HAARP seems to be the greatest and most prolific technological work of the Twentieth Century, the wonder and acme of modern covert science! Yes, the Eastlund patents must be the marvel of this age, since so many additional attributes have been daily appearing under the topic headline. In actually reading this patent description, one would imagine that Dr. Eastlund has found the very Lamp of Aladdin. The conspiratorialists have inferred that this patent group is made to produce regional mind-manipulation techniques, resonant disturbance of biorhythms, artificially driven circadian cycles,

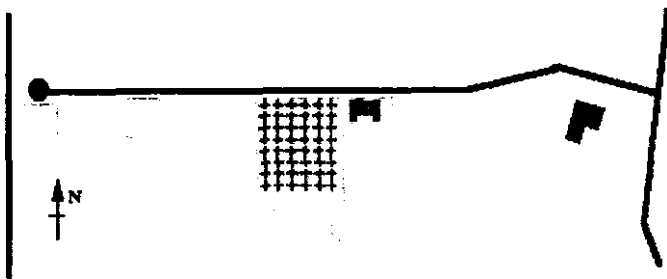

Map of the HAARP Site showing the current development and placement of antenna array, equipment buildings, and nearby roads. Map from the HAARP Web Site.

induced insomnia and neuroses, and paranoia and terror psychotronics. I will not disallow that such weapons exist. But I will not allow readers to imagine that the Eastlund claims have any ability to achieve these objectives. In fact, HAARP has nothing to do with these patents.

In point of fact, the Eastlund patents were a series of grant proposals written during the waning days of SDI. Designed to attract any potential Military or Energy Industry attention, this patent series aimed only at finding a patron. To be blunt, the Eastlund patents lack both utility and merit. The author did nothing more than quote the achievements of several past geophysical researchers, claiming that his design could do all that and more. The Eastlund patents are comprised of a textual slurry which a brief reading clearly reveals. The whole of his patent wrapper is a shameful multiplication of contradictions.

The outlandish and self-aggrandizing nature of claims made by Dr. Eastlund provoked an honest patent examiner to refuse the granting of license on first sight. The reason for rejecting the application was straightforward. "The invention as disclosed is inoperative and therefore lacks utility". Our consistent opinion remains in agreement with this assessment. HAARP can achieve none of the proposed claims which conspiracy texts so freely assert. Furthermore, if these hysterical writers would only learn their material better, they would realize that HAARP has nothing at all to do with Tesla Technology. HAARP employs technology which Tesla continually berated! HAARP is the very antithesis of systems developed by Tesla, and only uses the Tesla name as a very effective publicity buzzword.

If HAARP has indeed achieved any of its aims, it certainly has achieved the original goal for which it was drafted. Dr. Eastlund successfully attracted several communities with very different agendas. I do not for a moment believe that he expected to ever implement the plans which he so bombastically outlined in his texts. Indeed, one must congratulate the public relations work which preceded the acquisition of these patents. Based on engineering finesse and scientific soundness, no such good fortune should have followed. Patents such as these never merit more than a critical few paragraphs in the journals. Are any of these claims original and new? No, not one. Each of his claims has already been made by a great number of other geophysicists throughout the previous decades. Is there anything about his

system which is creatively different or somehow original? Again, each component of the Eastlund proposal represents a great number of patents already in existence. These are patents which are singularly uninteresting. When compared with the newly uncovered files, the IRI actually appears quite bland and ineffective!

In fact a precursory survey of many other patents is sufficient to reveal working systems and tested experimental hardware capable of totally outstripping the Eastlund proposal on several fronts. We emphasize the term "proposal" because nowhere does the Eastlund device exist in model form. A proposal parading as a patent! Never has such a precedent been set in American patent history. One therefore questions the means by which such a *fete accompli* has been so successfully managed. Dr. Eastlund made his mark, and won his grant!

One issue must be made crystal clear before my discussion continues. The assumption that the Eastlund patent group forms the very heart of HAARP is completely unfounded. Other patents support my assertion. Claiming this single group of patents to be the pivotal technology on which HAARP is based, especially after reading the textual descriptions and claims, is obscenely embarrassing. Worse than this initial mess of misinformation are those who lump the Eastlund patents together with a host of completely different applications. Compounding error upon error, it is then assumed that the Eastlund claims are the sole contributors to the HAARP Project, which is an outright lie and misrepresentation. But these misgivings are useful in the search concerning HAARP. They lead us to penetrating and more deeply hidden truths.

Casual examination of the advisory committees surrounding the HAARP Project does not give us adequate additional information. On the surface it appears that military, academic, and commercial interests have together merged their interests in the Project. Because of this tripartite structure, many have inferred the several usually mentioned possibilities in connection with HAARP. Why would such a huge and thoroughly connected conglomerate as Raytheon be suddenly moved to buy out the Eastlund patents at all? What real "merit" did Raytheon see in these ill-conceived and all too erudite sounding proposals? Furthermore, was this small representative package the only group which Raytheon acquired in its very obvious survey?

RAYTHEON

As with so many other designs, Raytheon acquired the rights to the Eastlund patents for a singular developmental purpose. The Eastlund patent collection certainly does not represent a system capable of achieving any of its proposed applications. Previous geophysics research teams achieved what Dr. Eastlund claimed as original. Surely Raytheon did not wish to simply reproduce the list of previous geophysical achievements! But perhaps Raytheon was interested in buying out all the relevant Eastlund-like patents that year simply because it had already decided to develop an original system for other purposes. Very

lucrative purposes. In such a case, we would then assume that Raytheon's act of purchasing the complete Eastlund patent series was an unintentional disclosure of intent! We would therefore never expect the Eastlund patent to appear at all in the Raytheon HAARP project. In fact, photographic evidence proves this assertion to be correct. Neither diagrammatically nor descriptively, the IRI has nothing at all in common with the Eastlund disclosures. Whose design then is the IRI? And why is it such an overtly poor example of engineering design?

The Eastlund patent group was certainly not the only such representative which Raytheon acquired when it "swept the patent floor". This is common practice in business when one wishes to eradicate potentially threatening technologies. The concomitant fact that Raytheon directed the actual building of HAARP has eliminated that scenario. Why then did Raytheon buy up all of these patents on ionospheric heaters? Because it wishes to deploy a weapon? How ridiculous. Weapons are deployed with no permissions or requests. Infringement suits do not occur when military directed projects are concerned. But why did Raytheon, megalithic defense contractor, acquire such patents at all? Furthermore, why did Raytheon form separate management groups for the development of its HAARP Project?

The intense military involvement surrounding HAARP is always equated with weapons research. Indeed, many inexperienced analysts conclude that HAARP is a weapons project on this basis alone. But it is no such thing. One must examine the scenario in question before jumping to such prejudicial conclusions. Why is the military overseeing a commercial venture? On whose behalf are such strict research directives being enforced? Those who read the military involvement in HAARP as proof of a secret weapons program have not logged in the adequate research time. Had they done so, they would never have arrived at these pedantic and embarrassing conclusions. After multinational business initiates high-tech projects, the military is employed to organize and complete the project. Business commands, military obeys. Military advisement necessarily forms the heart of every such project, whether it be toward the development of weapons or pipelines. The military keeps active files on all science professionals in the nation.

Paramilitary Intelligence studies the progressive development of specific individuals. Military leadership oversees every aspect of such technical projects until completion for good reasons, recruiting specific kinds of professional researchers from the academic world. Such recruits are not always the highest and most exemplary representatives of their profession. They are often "green" to the military-academic system, often young graduates with no prior experience in the trade. The pay is too good to refuse. Military convention has long learned how to successfully choose its professional liaisons, rejecting those highly intelligent individuals whom they perceive as unmanageable security risks. Professionals who eventually recognize what they are developing also realize that they themselves hold the high card in a multinational game plan. Such persons are never desired.

For this reason, a large number of technically adept persons, usually military trained, are massed together in any one facility. Low level academic representatives are carefully placed among this mass of military technicians. Professionals who work well in this quasi-military structure become familiar faces in multinational initiatives. No one such professional is ever permitted to know too much of what the others are doing. Academic involvement in largescale projects equates with endless expenditures in time and money. In addition, professionals who are absolutely needed place personal demands on groups who have temporarily forsaken all civilian pleasantries. The eccentricities of professorial employees have traditionally been quashed at the moment of their expression by military leadership. This has produced legendary separations between military and academia. Military leadership drives each such project to its conclusion, clipping the otherwise endless applications of useless fascinations so typical of professorial researchers.

Neither business nor military are in love with the wonders of nature, the marvels of science, or the beauty of technology. Theirs is not an appreciation of the sublime. They want domination. Rulership. Preeminence in the world. Because of this predilection, military is given monies with which to devise "tactical means". Cartels demand sureties for their investments. In order to maintain the imperial upperhand on behalf of its multinational employers, military requires new weaponry. International adversaries, political amalgamation, are funded by warring cartels. The hierarchy of business exchanges and strategies uses the populace as a slurry pit for the movement, extraction, and multiplication of profit. Nothing more. Being the commodity in this cruel use of our lives is the true source of our deepest sentiments of fear, distrust, and hopelessness.

Commercial involvements simply equate with lucrative contracts and government funded weapons ventures. And there are of course those who admix each of these involvements in varied proportions, obtaining conclusions which never reach resolution. And so the conspiracy theories continue spinning their intrigues, all the while missing the obvious. The fact that all of these inferences comprise an incoherent pattern, one designed to misdirect the imagination, is strangely never itself examined. While several writers have made much mention of the military in strict connection with HAARP, it is not the military which directs or pursues projects such as HAARP at all. For all its weaponry, its steely severity, its polished poise, its stripes and banners, the military is but a tool in the hands of its masters. The military is a task oriented hierarchy, made to obey the commands of a highly bureaucratic legislative branch, themselves receiving dictatorial command from the multinationals. There is no other way to interpret the otherwise irrational military conflicts of our time.

How many times has the gloved hand been wielded for the superlative goals of altruism? How much more has it not been wielded in the selfish brutality of imperialistic control? The military hand is now simply a tool to effect possession of foreign resources. To cover this function, elaborate intelligence opera-

tions set up the game board for public witness. One cannot occupy a nation which does not appear to be a threat, in order to seize and use its resources. Indeed, every war since World War II has had only financial objectives first in mind. Wealth, power, control, regulation, and technology. These are the ruling principalities in the bureaucratic hierarchate. Agencies bow in homage to these stone idols. If there is money and power to be gained in a potential market technology, then any outlandish project will be entertained, funded, and deployed. The United States Government has traditionally employed their military hierarchy when desperate to achieve a technological objective. Military in turn implements its stern might in both seeking potential projects, recruiting the very best researchers, and deploying the most expensive experimental apparatus.

IONOSPHERIC RESEARCH INSTRUMENT

HAARP is a project whose Staff and advisement council having been determined by Phillips Laboratories (Air Force) and the NRL directly. Built on the Alaskan North Slope near Gakona, the "Ionospheric Research Instrument" (IRI) is built on land which is owned by the Department of Defense. For this reason alone many inexperienced scholars have concluded that the IRI is a weapons project. Nothing can be further from the truth. When one is developing a revolutionary technology, having potential entanglements and infringements from commercial and private sectors, one sweeps the patent floor. Were Raytheon operating on behalf of a military weapons project, they would never have called attention to themselves in purchasing these rights. Therefore, Raytheon's involvement in HAARP is a mystifying commercial venture. The seemingly sizeable payments paid out when acquiring potential contestants is infinitesimal when compared with the projected profits of a revolutionary new commercial technology.

Open your eyes and see what the photographs tell. The first impression reminds the trained eye of a powergrid. Look at the intertangled array of HF structures. The IRI as presently established consists of a primary HF transmitter field, an assemblage of HF antennas, and a host of sophisticated diagnostic equipment. The IRI itself is owned by Raytheon, managed through E-Systems, and constructed by Power Technologies Incorporated (APTI). Examination of the photographic evidence is thoroughly disappointing. The HAARP site is not the monstrous multigabled structure which befits the hysterical claims. A pitiful assemblage of frail uprights and cross wires, the scene resembles those monstrous arrays of Marconi Wave Radio. Nothing appears novel or inspired. A total of 180 towers will comprise the IRI. Each tower stands 72 feet high. The lot on which this fastidious assembly stands covers a 33 acre field, having dimensions 1000 by 1200 feet. Each tower is founded on a 12 by 15 foot rectangular base. These are each spaced 80 feet apart. So much for the physical dimensions. Tesla achieved much more with less space.

In its current phase, the IRI is unfinished — the Developmental Prototype (DP) consists of 48 antenna elements, of which only

18 are currently active. Each of the towers support a double crossed dipole. One dipole set operates from 2.8 to 7 Megacycles, the other set operates from 7 to 10 Megacycles. Beneath the entire vertical array of the proposed IRI will be a 33 acre copper screen. Poised on insulators 15 feet above the ground, vehicle access to the various shelters is facilitated. Prime electric power for the IRI is provided by six diesel driven 2.5 Megawatt generators. Radioenergy for the huge assembly is derived from transmitters which are housed in 30 separate shelters spread across the acreage. Each shelter contains 6 pairs of 10 Kilowatt transmitters. Even in its completed phase the IRI will be bombastic and ineffectual.

Vertical radiations from this array are phased controlled to produce circular polarizations. The vertical beam can be skewed and therefore aimed toward various compass headings, a process which diminishes the effective energetic cross-section at the target site. The IRI can focus its radiant energy to a tight point in various selected ionospheric strata. Concentrated radio energy from the IRI is frequency directed into these specified strata. There the energy is absorbed in a layer a few hundred meters thick, a process which requires deeper examination. But more fundamental and immediate questions need be asked here. What is the IRI, and why was it built?

The time for extensive expenditures on new weapons projects commenced with SDI in 1983 and was discontinued by the end of the same decade. While the divergent applications of the IRI have been mentioned, it is rather obvious that this huge test facility is no weapon. Citing functions by which the IRI can effect controlled conjugate auroral storms along longitude lines (poised so close to magnetic north), the IRI can conceivably trigger such storms as far as the south pole! The mirror effect binds energized particles between fixed magnetic reflection points. As a potential means for effecting auroral storms, the IRI is an unlikely candidate for a functioning weapons system of any dependability. But considering the IRI to be a beam weapons system is part of the repertoire of paranoia, an anachronistic and foolhardy evaluation. Why would the military spend billions on so large and unwieldy a target as the IRI if it were a weapon? The IRI cannot achieve weapons objectives. Neither can it launch clustered particle beams along the geomagnetic field lines to specific targets. To be sure, the IRI is no weapons project.

In a more benign function, military releases have mentioned the IRI in conjunction with surveillance technology. But the IRI is no mere military listening post. The overwhelming number of military satellites can do far better in the surveillance arena. Those who claim that "deep earth tomography" is a possible application of the IRI have much to learn in basic physics. Recall that ELF wavelengths literally span continents. How are such waves to be employed in a technique which would seek out the detail of "subterranean tunnels"? Such tomography requires the projection of waves very much more minute than infrared. Those who cite ELF methods in this respect simply do not understand the nature of ELF and its inability to reveal such detail. Waves this large can define nothing smaller than their

UTILITY

Issues of the game become more complicated as efforts to achieve domination of world resources intensify. In this regime of weapons proliferation between warring cartels, both the United States and the Soviet Union were driven to the point of economic failure. Amid the proliferation of high-tech weapons systems and erudite scientific research, an everpresent and obsolescent commodity was elevated to the level of demigod. Oil became the world central focus, in a most curious manner fixing all eyes on the ancient heart of civilization. Oil drove every sophisticated personality back to a desert where descendants of shepherds became self-styled royalty. The charades were ludicrous. Roads in deserts built in circles so that sheiks could be chauffeured in air conditioned Austin-Martins. Cartels patiently endured the frivolities of this masque, while deliberating their own means for undoing the unexpected new game players.

Hamer had already outbalanced this new variable with his own oil fields in the North Atlantic. Having funded a new deep well offshore technology, Hamer himself had become the major opposition to OPEC. How curious that, with his death, both the Berlin wall and the Soviet Regime very swiftly came to an end. The world was suddenly not a one-sided game board where imperialistic ideologies could exist unchallenged. There are many others who came to play the game, and played it very well. In all of this, Technology emerged as the singular decisive means for achieving dominations in world markets. Business makes its demands. Military organizes. Technology produces.

Wars need not involve the rumble of military might at all. A new technology may emerge, threatening the stability of some cartel. In such scenarios it has been convenient to assassinate the potential new technological dictator and undo the technology. In other cases, the reverse may actually occur. On the surface, the condition is simply determined by those who hold the capital. If there are factions whose domination of a resource has wearied other cartels, then a new venture will be sought to undo those dominations.

Technological creation of new markets has not always been pursued by world major cartels. Stability and status quo has been the theme of all investors for nearly a century. Investments are made and secured. They are not tested in the fields of venture. But technology is the "wild card". Technology destabilizes the status quo. Irrepressible technological progress has not been permitted to fulfill its expression in the world. Those who demanded a halt to progress managed to silence the wonder for a time. Nevertheless, a situation has now presented itself where even the cartels have demanded a world revolution in technology.

Let us suppose there existed a cartel whose total domination of a resource had grown so uncontrollable that it threatened every other existing business. Now suppose that the other cartels have realized that the essential dominating resource itself supplies an obsolescent technology. Realizing that the dissolution of the obsolescent technology spells defeat for the dominating supplier, all the threatened cartels will band together to develop



The structures that resemble umbrellas are the antennas used to direct HAARP transmissions upward. The shelters at the ground level house the transmitters used to generate HAARP's signals. From the HAARP Web Site.

own dimensions. How then can they resolve small subterranean tunnels beneath an equally small geographic section? Only X-Ray or Gamma Ray technologies can achieve these objectives with highest efficiency.

Conclusions such as these are evidence of unfortunate misdirected and unschooled zeal among those who are easily dissuaded from observing the obvious. Deep earth tomography can be accomplished by orbital means with far greater definition and access. All surface, submerged, or entrenched installations require the penetrating gaze of more powerful emissions. But the well documented and patented techniques of X-Ray and Gamma Ray technology will have been discussed, and will be available along with my forthcoming patent collection. Besides opening a great many debates on the obsolescence of every residual radiowave technology, we are left with a clear path through which to understand HAARP, a design which is by no means the most ultimate representation of its class. It is in fact a very poorly designed example of largescale influence-type transmitters.

While the IRI is an expensive experimental station whose data can be used toward the development of several distinct systems in the future, it is clearly an attempt in a singular direction. The IRI has been recently hailed as a "diagnostic tool" having multiple experimental applications. But what is the chief application of the IRI? What do our evaluations finally conclude? The one military release which attracts my attention is the least mentioned throughout the literature of hysteria. It is the one description which accurately matches the existing structure in Gakona. I am surprised that so few of the more prolifically verbal researchers have focussed their more scholarly attentions thereto.

a new and superior substitute. Oil is the resource whose revenues have given an underdeveloped handful such total dominating power in the world. The powerful enemies of this dominating influence have recognized the essential weakness in this resource as a fuel. Perhaps the eradication of revolutionary technology is no longer profitable. Other world cartels have had enough of OPEC, its flowing white robes, its intolerance, its sneering voices, and world-ruling policies. The attendant terrorist activities do not endear these persons to European multinationals. The other world cartels have found a new venture which will dethrone oil and make untold wealth for themselves. HAARP is their Project. But exactly what is the Project, and what are its real capabilities?

Since the official termination of SDI, new energy projects have had far greater levels of classification and importance. In the past, patent examiners were directed by privateers to screen all energy devices. The motive during that purge was elimination. The continual rejection of energy devices forced the nation to accept an inferior technology and a subordinated science. The privately viewed wonders of those powerful early energy devices taught a far superior science to a few. From that period onward, internal struggles among warring bureaucratic factions has prompted a new search. For energy devices to have bureaucratic utility, the heart of control and regulation must be satisfied. Installations must be large, costly, and distant. The secrets of such a science need not be too erudite, just physically unfeasible and inaccessible.

As previously emphasized, in its present form the IRI has nothing in common with the Eastlund patents. Nothing whatsoever. Judging from the patents alone, the Eastlund thesis has not been achieved in Gakona. It is in fact quite obvious that others have taken this proposal and made it into a thing which no longer resembles the original. So where is the merit? What compels the government to cover itself with the military, while investing such heavy fortunes in the Eastlund proposal? What do certain agencies see in the Eastlund patents? What is it about this system which so enamors the several jointly engaged parties?

Fuel and energy themes have historically proven themselves to be the central focus of power and control during this latter half of the Twentieth Century. Abundant proof of this is found in the opened forum which the media have granted us. Displaying every fuel imperializing military maneuver, we have recently witnessed countless over-indulgent occupations of underdeveloped oil-rich nations. If this is not true, then why is such a propaganda campaign overemphasizing the danger of minuscule and insignificant sheikdoms which fill the Middle East? The love of Liberty? Fuel and Energy drive the relentless wheels and maintain the precious Control. Energy is the demand. Energy is the single most valuable commodity. And of all energy supply, the generation of electricity is the most profitable.

It is obvious that the IRI has been deployed in the northlands to achieve a very specific and tantalizing objective. If it were not so, then the present design which we see would never have been given funding. The Caribbean Arecibo facility could certainly

have been outfitted with more powerful radar transmitters, and could have focussed more heat on the ionosphere than the IRI can ever hope to produce. In this light, the very construction of the IRI was a needless expense. But Arecibo does not have the northern access for which the IRI has been specifically based. In the words of the military releases, the IRI "stimulates and controls plasma processes" in the northern auroral zone. This is the most clarified comment made by the military press releases — the very one least favored by the popular writers. It is the very item upon which they continually stumble, the one which they reject. Look at the sheer size of the IRI. Why the enormous surface area? What has Raytheon already proven, and what are they hoping to perfect? Examine the evidence. Why is the IRI so close to magnetic north? The answer to this question is the secret, the very heart of the HAARP Project. The High Frequency Active Auroral Research Program. Why build so vast a station beneath the auroral ring? And what does Raytheon want from the Aurora Borealis?

FACTS

Knowing the facts is neither concession nor willingness to accept HAARP technology. Of this, make no mistake. We do not endorse, approve, or applaud this infernal deployment. Knowing the facts is not affirming the right of military engineers to continue deploying such projects. But knowing the facts empowers our confidence in relinquishing concern over a technology which, it will be learned, cannot wreak the environmental destructions which certain production crews are using to best lucrative advantage. Do not allow yourself to be used by conspiracy writers. They rely on your hysterical response for their success. You need facts. And only historical facts will clear the issues. Our science teaches that HAARP is not the threat which natural forces themselves represent. The fury of vulcanism and the monstrous potentials innate to solar flares so dwarves HAARP and the IRI as to banish all concern in the hysterical claims made by uninformed others. A well supplied bibliography informs me that qualitative science has answers to questions germane to the discussion of HAARP and the environment.

Finally, concern is tempered by knowledge. It is an item which does not easily become common hysteria. The loss of discipline in research slips into hysteria. Statements made in ignorance cannot be accepted with the gravity and concern so vehemently projected by the hysterical conspiratorial writers. There is nothing covert in HAARP which cannot be clearly affirmed through careful and meticulous study of the recently acquired patents. The historical bibliography provides every clear developmental path which led to these present designs. A treasurehouse filled with innumerable gem-studded ravines, we find the repetitive patterns crossing and recrossing in continual affirmations. These kinds of illuminated studies alone reveal the empirically discerned truths regarding both superhigh power microwave projectors and high power ELF devices. ■



SECRETS OF COLD WAR TECHNOLOGY

Project HAARP and Beyond

Gerry Vassilatos

THE death knell has struck. Wave Radio is dead. How have 70 years of Military Research succeeded in producing a completely new and superior communications technology? Radio History gives a stranger walk than paranoid writers ever tell! While citizens were watching television, military research was directed to create an amazing radiation technology far in advance of any system known. Currently and routinely utilized, it has remained a well guarded "open secret" for decades. The proof patents and relevant research papers have just been retrieved.

★ Discover why is it obvious that neither military nor private developers have yet successfully duplicated Tesla technology.

★ Why is the name H. C. Vion, developer of auroral energy receivers, never mentioned in engineering circles? Who was Dr. Selim Lemstrom, and how did his early explorations in auroral energy research inspire Nikola Tesla toward his lofty achievements in Colorado?

★ Successfully tested by British Military during World War I, what became of the early beam weapons of Grindell-Matthews, Ulivi, Turpain, and others? Who was John Hettinger, and how were his early beam power systems modified through radar technology into ray beam weapons?

★ What was Project Argus? Project Teak? Project Orange? How was the ionosphere successfully disturbed by a steady series of atomic detona-

tions in 1962? Learn about the frightful characteristics of EMP phenomena, and how these were employed in a strange and deadly technology. What different kinds of EMP weaponry did military developers deploy throughout the 1960's? Why was a High Command request to employ EMP weaponry in the recent Gulf War denied?

★ Discover why the Air Force directed the construction of a huge ionospheric "backscatter" telemetry system across the Pacific just after World War II. Find out why the controlled production of ionospheric disturbance was once important to military teams before the development of space travel. Learn why each of these mammoth global communications systems is no longer state of the art. How did the unexpected emergence of space technology speed the demise of earth based radio systems?

★ Not a weapon, not a psychotronics system, not a weather modifier, why is HAARP NOT the program which so many have claimed? Why can the IRI never achieve the objectives cited by a few authors? Learn about the real motivations so powerfully at work in Conspiracy Writers, and why they are not equipped to crack the secret of HAARP. Why are the Eastlund Patents not relevant to HAARP, and why has Raytheon continued to collect every HAARP relevant patent for several years? What is the "merchandise" which HAARP promises to yield?

★ What was Project Sanguine originally designed to do? Find out why it is not an invincible system. Learn why the ELF heart of Naval Command is eventually to be dismantled.

★ How were X-Rays used to detect underground movements? How were Gamma Rays routinely used in communicating from submarines to command headquarters via military satellites?

Facts quell hysteria, but Truth is stranger than fiction. Want the answers? This complete technical history of military projects will show the development of every relevant project preceding and exceeding HAARP. Only the facts. No hysteria. Complete with communications and weapons patent citations, this book will forever change your view of world events and technology.

SECRETS OF COLD WAR TECHNOLOGY - *Project HAARP and Beyond* by Gerry Vassilatos

Available from Borderland Sciences, #B0359, 250pp, paperback, ... \$15.95

ORDER YOUR COPY TODAY! (Please include \$3 for postage and handling)

BREAKTHROUGHS IN HOME HEALTHCARE

By Peter A. Lindemann

DURING the last few years, the amount of information about new alternative health methods in the public sector has literally exploded. Any one of these developments, by themselves, would constitute a breakthrough. Taken together, they constitute the beginning of a new era in home healthcare. So much information is out there, that BSRF offices get a steady stream of calls asking what we think about this or that claim. The purpose of this article is to review some of these developments, specifically, the work of Hulda Clark, ND, Robert C. Beck, D.Sc., and Joel Wallach, ND, and to place each of them in the context of the whole.

Certainly one of the biggest events in this trend is the appearance last year of the book *The Cure For All Diseases* by Hulda Clark, PhD, ND. Over 300,000 copies of this book are now in print. If you have not seen this book yet, definitely buy a copy. The basic premise of the book is that most conditions that people suffer from today are caused by parasites, mercury amalgam fillings and powerful toxic chemicals, like benzene, in trace amounts in our environment and food. When these problems are addressed and removed, health returns. Hundreds of case histories are cited as proof of this thesis. The book gives a set of plans so the reader may build a "Zapper" to kill off parasites in the body. This has spawned a backlog of demand by people who want a Zapper, but do not want to build one themselves. Multiple manufacturers are now making Zappers available to the public, based on Hulda Clark's design.

Many health professionals that I talk to think that Hulda Clark's premises are basically correct, but that her diagnostic method is faulty and her remedies either go too far or don't go far enough. Clark has a tendency to draw sweeping, generalized conclusions from limited data. One example is her recommendations concerning dental care. She claims that ALL METAL must come out of the mouth, not just the mercury amalgam fillings. She also claims that if you have a root canal, you should have it extracted immediately. For people with extreme sensitivities, these recommendations may be appropriate. Certainly, they are not necessary for everyone. The general consensus among Alternative Health Professionals is that ALL MERCURY

amalgam fillings should be removed as soon as possible. Mercury is a known heavy metal toxin to all forms of life, including humans. We should not be breathing mercury vapor with every breath. Any porcelain or gold crowns that have mercury amalgam underneath them should also be removed and replaced. Besides mercury, another big problem is associated with having two or more different metals in the mouth at the same time. Even a basic chemistry class teaches you that two dissimilar metals immersed in an acid solution creates a BATTERY. The combination of mercury amalgam fillings, gold fillings, and saliva invariably generates electricity in your mouth. These so-called "buckle currents" can easily be measured on a simple multimeter purchased from Radio Shack. Having a battery in your head 24 hours a day is definitely unnatural and stressful to the body. Many people suffering from unresponsive, chronic health problems, especially digestive problems, do find relief when the mercury and buckle current problems are removed. Some people need to go farther than this, but many do not. Only accurate testing of each individual can determine the appropriate course of action. On the other hand, I have no doubt that if basically healthy people follow Hulda Clark's suggestions regarding these dental problems, they will be much healthier. Many people can and do recover their health without going to the extremes Clark recommends.

The biggest rage coming out of Hulda Clark's work relates to parasite eradication and the use of the so-called "Zappers." These are simple electronic devices that chop (turn on and off) the current of a battery and apply it to hand held electrodes. She claims that chopping the current at ANY FREQUENCY between 10HZ and 500,000HZ will KILL all viruses, bacteria, fungi and all other parasites including round worm, flat worm, liver fluke and more in as little as 7 minutes! She then goes on to recommend that you do this 3 times a day for 30 days or more. The simplicity of the technique and the claimed effectiveness has lead thousands and thousands of people to try this. Reports coming back give mixed reviews.

The GOOD NEWS is that zapping apparently can kill many types of parasites in the body, quickly. The BAD NEWS is that

this technique is VERY STRESSFUL to the body. Radionic practitioners I have spoken with claim that vitality readings of the brain, heart and lymph system can drop to ZERO after only ONE treatment. These vitality readings do return to their previous levels over time, but the clear indications are that treatment by the Zapper is hard on the system. People with any kind of heart problems should not use Hulda Clark's Zapper! Every sensitive I know will not use the device because it disrupts the subtle energy fields of the body quickly and deeply, causing energy to reverse direction in meridians and chakras to spin backwards.

To be fair, Hulda Clark does admit that the Zapper treatments do not penetrate all locations in the body. For instance, she specifically states that zapping does not penetrate the contents of the bowel (a prime location for parasites), unnatural calcified structures like gall stones, or hollow structures like the inside of the eye ball. One engineer I spoke with suggested that the higher the frequency of the device, the LESS effective it would be because high frequency currents have a tendency to travel on the surfaces of conductors (the so-called "skin effect"). Most commercially available Zappers operate at about 14KHZ. Obviously, for the device to be effective, the electrical signals must deeply penetrate all tissues of the body.

Another problem that Clark has not understood is the appearance of HARMONIC FREQUENCIES in a square wave. She claims that to be effective, the Zapper must emit frequencies in the range of the parasites (100 KHZ to 800 KHZ), which it does. But she says that the range of frequencies for the human body is between 1.5 MHZ and 900 MHZ and that to put these frequencies into the body would be harmful. Well, a square wave with a fundamental frequency of 14KHZ is RICH in harmonics in the 1.5 MHZ to 900 MHZ range!

Part of the problem with Hulda Clark's method and the source of her exaggerated and false claims is her diagnostic protocol. She uses a simple device that creates a biofeedback bridge to control the amount of current applied to a small audio speaker. When various substances are placed in the circuit, the electrical resistance of the subject being tested changes momentarily, changing the sound coming out of the speaker. The practitioner doing the testing listens for a specific "resonance" quality in the changing sound patterns to determine if the substance being tested is present in the subject being tested. (This device, which she calls a Syncrometer, works like an inexpensive version of the Dermatron or Vegatest machines.) This is essentially a RADIONIC testing method, and it has all of the same limitations of other radionic methods. Clark apparently has no concept of the problems radionic practitioners have faced over the years, such as ORANUR and other MASKED conditions which can create both "false negative" and "false positive" indications. For instance, Clark claims that after three 7 minute Zapper sessions, her diagnostic method indicates that ALL PARASITES IN THE BODY ARE DEAD! However, within a few days, diagnostic indications of the presence of parasites return. She apparently does not understand how the

Zapper stresses the body, creating its own masking effects that her diagnostic method cannot read through. From what I can see, her diagnostic equipment is adequate. However, her protocol and the interpretation of her testing results are sophomoric and lack the wisdom of a broader perspective. Hulda Clark may be a remarkable and forward thinking Naturapathic Physician, but when it comes to electronics and Radionics, she is a rank amateur. I personally know of one person suffering from prostate cancer who went to Dr. Clark's clinic in Mexico, did her entire parasite cleanse and all other recommended procedures under her supervision, and was NOT cured.

In spite of these drawbacks and cautions, the book has a wealth of information in it about parasites and environmental toxins and should be on everyone's bookshelf as a ready reference. The Clark Zapper does apparently kill a wide range of parasites slightly faster than it kills you. Because of this, thousands of people have used it effectively, unaware of the safety concerns raised here. If you decide to use the Clark Zapper, I recommend that you tune it to a primary frequency of about 50 HZ, add some filtering to remove all frequencies above 1MHZ, and use EXTREME CAUTION.

Killing off all viruses, bacteria, fungi and parasites in your body is well worth doing, and there appears to be a much safer way than Clark's Zapper. On November 16, 1990, Dr. Steven Kaali and his associates at Albert Einstein College of Medicine in New York City, filed a Patent on a new process to clear the blood of pathogens. On February 23, 1993, the United States Patent Office issued Patent Number 5,188,738 to Kaali et al. on an "Alternating current supplied electrically conductive method and system for treatment of blood and/or other body fluids and/or synthetic fluids with electric forces". The following is excerpt from the Patent Abstract: "A new alternating current process...for treatment of blood...with electric field forces...to provide electric current flow through the blood...at a magnitude that is biologically compatible but is sufficient to render the bacteria, virus, parasites and/or fungus ineffective to infect or affect normal healthy cells while maintaining the biological usefulness of the blood..." "For this purpose low voltage alternating current electric potentials are applied...which are of the order of from 0.2 to 12 volts and produce current flow densities in the blood...of from one microampere...to about two milliamperes..." This patent, and 14 others that have issued since then, all describe a process where a patient's blood is removed from the body, run passed a set of electrodes where the electricity is applied, and then returned to the body after treatment.

Quoting from the body of the Patent, "...treatment of virus in media at 100 microamperes for 3 minutes has been observed to substantially attenuate (render ineffective) the AIDS virus. Similar treatment at other field strength values and lengths of time will have similar attenuating effect on bacteria, virus, parasites and/or fungus which are present in blood or other body fluids being treated."

To put this all in layman's terms, it has been discovered that passing very small amounts of electricity directly through the

- (54) ALTERNATING CURRENT SUPPLIED ELECTRICALLY CONDUCTIVE METHOD AND SYSTEM FOR TREATMENT OF BLOOD AND/OR OTHER BODY FLUIDS AND/OR SYNTHETIC FLUIDS WITH ELECTRIC FORCES
- (76) Invention: Steven Kaali, 21 Ashford Ave., Dublin Ferry, N.Y. 10223; Peter M. Schwelby, 4101 Cathedral Ave., NW, Washington, D.C. 20016
- (*) Notice: The portion of this term of this patent subsequent to Aug. 18, 2009 has been disclaimed.
- (21) Appl. No.: 615,437
(22) Filed: Nov. 14, 1990
- Related U.S. Application Data
- (30) Continuation-in-part of Ser. No. 342,731, Aug. 6, 1990, abandoned.
- (31) Int. Cl. B01D 35/04, A61K 41/00
(32) U.S. Cl. 210/768, 128/419 R, 128/431, 128/782, 128/784, 204/111, 204/164, 204/184, 204/202, 210/243, 432/22, 432/44, 604/4
- (34) Field of Search 210/243, 748, 764, 128/419 R, 431, 783, 784, 604/4, 432/22, 44, 204/121, 164, 184, 242, 275, 302, 303
- (34) References Cited

U.S. PATENT DOCUMENTS

392,728	10/1977	Jones	204/242
471,231	4/1991	Lorenson	204/273
1,068,738	12/7749	Dutlinger	204/285
1,088,646	9/1977	Wiedoff et al.	204/129
1,713,886	6/1977	Myers	204/186
1,876,364	6/1977	Yee et al.	210/648
1,964,889	6/1976	Devoon	422/22
1,984,799	11/1976	Yee et al.	210/211-64
4,472,449	9/7904	Kishida et al.	204/701
4,644,698	10/1988	Kaali et al.	128/180
4,776,187	9/1988	Kaali et al.	128/788
4,922,421	6/1990	Kaali et al.	128/331
1,889,329	9/1991	Marrall	210/243
1,885,043	10/1991	Stevak	128/783
1,153,932	7/1992	Gunn et al.	210/743

FOREIGN PATENT DOCUMENTS
953446 7/1993 U.S.S.R. 210/743
OTHER PUBLICATIONS

Proceedings of the Society for Experimental Biology & Medicine, vol. 1, (1979), pp. 204-209, "Inactivation of Herpes Simplex Virus with Methylene Blue, Light and Electricity"—Michael E. Swartz et al.
Journal of the Clinical Investigation published by the American Society for Clinical Investigation, Inc., vol. 61, Feb. 1980, pp. 432-438—"Mechanisms of Photodynamic Inactivation of Herpes Simplex Viruses"—Lawell E. Schlimper et al.
Journal of Clinical Microbiology, vol. 17, No. 2, Feb. 1983, pp. 374-376, "Photodynamic Inactivation of Pseudomonas Virus with Methylene Blue Dye, Light and Electricity"—Janine A. Budyak et al.
Primary Examiner—Robert A. Devison
Assistant Examiner—Sam Ull Kim
Attorney, Agent, or Firm—Charles W. Holzer

ABSTRACT

(57) A new alternating current process and system for treatment of blood and/or other body fluids and/or synthetic fluids from a donor to a recipient or storage reservoir or in a recycling system using novel electrically conductive treatment vessels for treating blood and/or other body fluids and/or synthetic fluids with electric fields of appropriate electric field strength to provide electric current flow through the blood and/or other body fluids at a magnitude that is biologically compatible but is sufficient to render the bacteria, virus, parasites and/or fungus ineffective to infect or affect normally healthy cells while maintaining the biological usefulness of the blood or other fluids. For this purpose, an alternating current electric potential is applied to the treatment vessel which are of an order of from about 0.2 to 12 volts and produce current flow densities in the blood or other fluids of from one microampere per square millimeter of electrode area exposed to the fluid being treated to about two milliamperes per square millimeter.

31 Claims, 6 Drawing Sheets

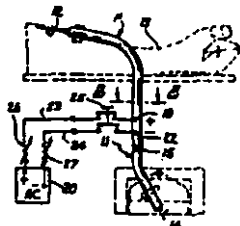

blood neutralizes the activity of viruses, bacteria, fungi and parasites in the blood. Since this effect occurs only in the electrically treated area, repeated applications are necessary to render ALL pathogens in the blood stream neutralized.

In essence, doctors at Albert Einstein College of Medicine discovered the cure for ALL INFECTIOUS DISEASES in 1990! Fifteen US Patents have issued to date on methods of applying this discovery to expensive hospital treatments, similar to kidney dialysis, where blood is removed, treated, and returned to the patient. The media has ignored the biggest medical breakthrough of this century and your doctor does not know about this treatment.

When the first news stories of Dr. Kaali's discovery were published in March of 1991, they came to the attention of veteran Borderlander Robert C. (Bob) Beck, D.Sc. After an initial

investigation, which proved the story true, Bob set out to develop a method to apply the discovery to home use. He designed two simple devices and published (gave away into the public domain) their schematics so ANYONE could build them and gain the benefit. In a speech he gave last year at the Global Sciences Conference, he says "this is God's gift to humanity.." and he doesn't want it to be exploited or controlled by monopoly interests. At this point, there are more than 40 different groups manufacturing variations on Bob's devices worldwide. Reports coming back describe complete cures of cancer, AIDS, Lupus, Epstein Barr (chronic fatigue syndrome), and a host of other deadly or debilitating diseases. With continued use, these devices have repeatedly produced a condition now called "immortal blood" where the bloodstream is free of all pathogens and blood samples do not breakdown even after being left on a microscope slide for a month!

Bob's protocol for the cure of essentially every infectious disease includes 3 steps: direct applications of electricity in the blood, induced applications of electricity (by magnetic pulse) in the joints, organs and lymph system, and the use of inexpensive, home made Colloidal Silver. He is 71 years old now, but feels he has finally done something that has genuine significance for the betterment of humanity. During the last 4 years, he has continued to give away into the public domain, multiple updates of the design of his devices and the protocol for their use. He has traveled and lectured continuously and funded his research from his own pocket.

In order to get the story straight, I spoke with Dr. Beck by telephone in late June and early July of this year. I asked him about the advent of the magnetic pulse device, since that is NOT inherent in the protocols of Dr. Kaali's Patent. He told me that

"... to provide electric current flow through the blood or other body fluids at a magnitude that is biologically compatible but is sufficient to render the bacteria, virus, parasites and/or fungus ineffective to infect or affect normally healthy cells while maintaining the biological usefulness of the blood or other fluids ..."

he developed the first battery operated xenon flash units used in photography back in the 1940's, during World War II, when he was a teenager. By 1946 he was already playing around with coils attached to these circuits to create strong magnetic pulses. He told me his favorite use, back then as a mischievous youth, was to put a penny in a parking meter and then

blast it with his magnetic pulser. This would pop the spring loaded timer mechanism in the meter and effectively provide "free parking" for months. From such humble beginnings, humanity trudges forward.

From the literature, Dr. Beck knew that AIDS and other viruses hide in the lymphatic system and other locations of limited blood flow. There had to be a way to induce the appropriate current flows in these areas as well to affect the complete application of Dr. Kaali's discovery. So, the "Meter

EXPERIMENTAL IN VIVO BLOOD CLEARING DEVICE FOR ELIMINATING VIRUSES, PATHOGENS, MICROBES, BACTERIA FUNGI, AND PARASITES.

Revision March 16, 1996 Copyright © 1991/1996 Robert C. Beck

Note: These data are intended for informational, instructional, and research purposes only and are not to be construed as medical advice. Consult your licensed medical practitioner.

CHANGES since previous editions: Pulse Repetition Rate from 0.67 to ~4 Hz. (Not critical). C 2 from 1 to 0.22 μ F. Voltage from 36 to 27V. Treatment time increased to 2 hours daily for 21 to 30 days. Improved electrode design and single wrist electrode placement. SW 2 added to extend battery life. There are NO "errors" in this schematic. Hundreds have been constructed successfully when duplicated exactly without user attempted "improvements".

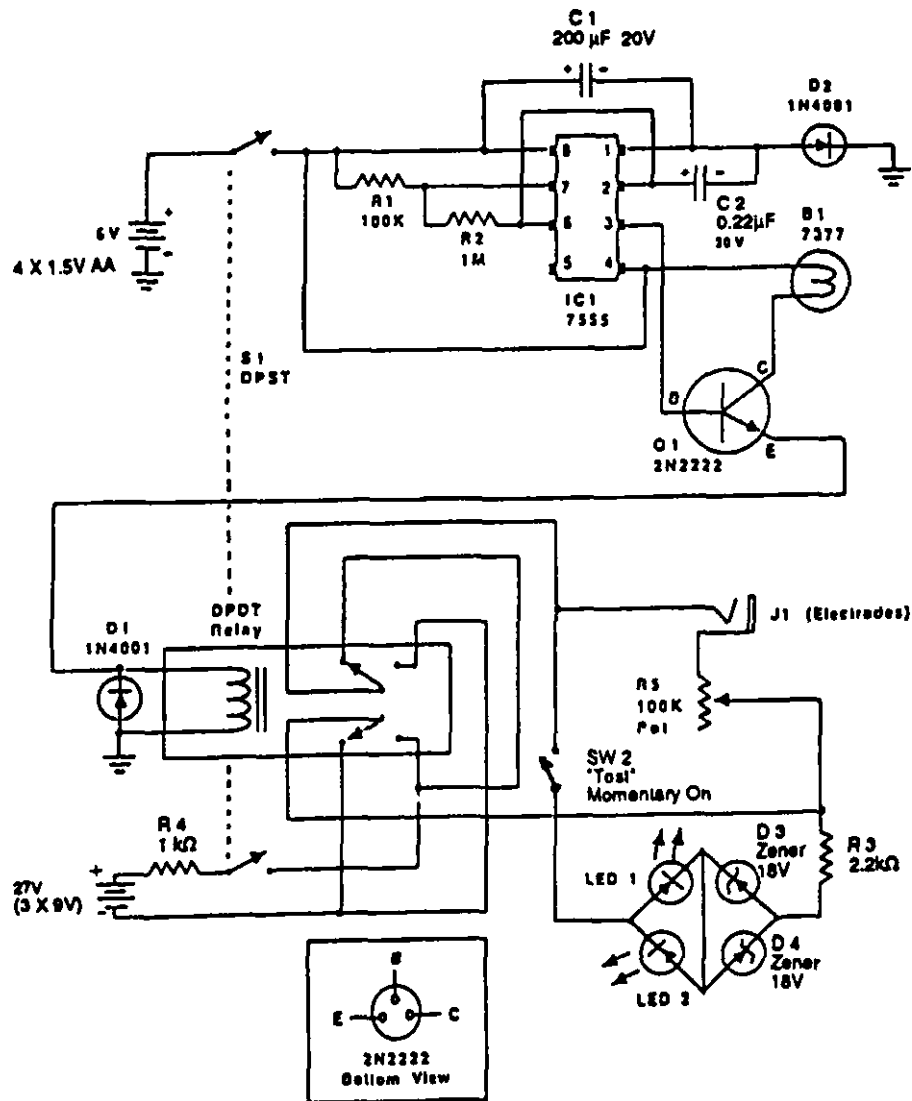

SPECIAL PARTS

- B1: Filament type Incandescent bulb, 6.3V .075A type 7377 (Ballast & current limiter.)
- Relay: 5V 50 Ω coil, PCB mount DPDT; Selecta Switch SR15P207D1.
- D3 & D4: Zener Diodes, 18V 1/2 watt NTE 5027A.
- R5: 100k Ω 1/2 watt linear potentiometer; Caltronics P-68 or equiv.
- LED 1 & 2, combined as Bicolor red & green in same housing, Radio Shack # 276-012
- SW2: "Test" SPST momentary on subminiature push-button, Radio Shack # 275-1571

PROPOSED THEORETICAL IN-VIVO BLOOD HIV, PATHOGEN, PARASITE AND FUNGI NEUTRALIZING DEVICE

COMPONENT DESCRIPTIONS, SOURCES, AND CURRENT PRICES (March 1995)

Revision March 13, 1996. Copyright © 1991/95 Robert C. Beck

Note: These data are for theoretical, informational and instructional purposes only and are not to be construed as medical advice. Consult with your licensed medical practitioner. Note; Some builders have ego problems with following instructions (*Not Invented Here*) and like to find "mistakes" or possible "improvements". Hundreds have been built successfully & duplicated exactly as shown.

Do not expect this device to function optimally if ANY electrical changes or ego improvements are attempted.

7555 CMOS timer chip (generic)	IC1	\$ 1.80	
100 k ohm 1/4 watt 5% resistor	R 1	.07	
1 meg Ω	R 2	.07	
2.2k Ω	R 3	.07	
1 k Ω	R 4	.07	
100k Ω linear taper pot, 1/2 watt Caltronics P-68	R 5	2.58	
200 μ F 20 V (or higher) electrolytic capacitor	C 1	.45	
0.22 μ F Tantalum	C 2	.25	
1N4001 diode 2 required @ .15	D 1 & D 2	.30	
18Volt Zener diodes, 1/2 Watt, 2 @ .79	D 3 & D 4	1.58	(NTE5027A)
NPN Transistor, generic 2N2222	Q 1	.30	
Bulb, 6.3V .075 A type 7377	B 1	1.34	
Relay, 5 V 50 Ω coil PCB Mount DPDT Selecta Switch	SR15P207D1	5.45	
Misc. wire, solder, etc.		.50	
Note: Action now supplies a custom printed circuit board #PS-PCB for:		15.00	

**All 15 components listed above available at ACTION ELECTRONICS
1300 E. Edinger, Santa Ana, CA 92705 (714) 547-5189**

Bicolor LED red/green Radio Shack #276-012	LED 1	\$ 1.19	
Jack for electrode leads 274-251 3/\$1.59	J 1	.53	
DPDT switch, 275-826 or equiv. (Used as DPST)	SW 1	2.55	
SPST Submini momentary push button switch	SW 2	.59	ER-SW101 "Test"
Battery holder, 4-AA cells, Radio Shack	270-383	1.29	
4 Alkaline AA cell batteries, #23-552	4 for	2.89	
3 Alkaline 9V batteries, type 1604 etc.	3 for	3.75	
3-9V battery snaps (clip-on connectors)	270-325 pkg 5/\$1.29	1.29	
Box, if used			\$ 2.29

Above items generally available at local Radio Shack stores

Lead wire with 3.5 mm plug, 6 ft., Mouser or Calrad Electronics		.35	
Electrodes, stretch elastic, Velcro, cotton flannel, alligator clips, etc.		± 5.00	(See notes)

Total Cost for all components for do-it-yourself project \$ 49.24

This design is basically a 7555 IC timer chip set for 50% duty cycle and ~3.9 Hz. driving a sub-miniature relay. Electrode polarity continually reverses ~1/4 second positive / 1/4 second negative. Frequency is not critical.

Patents applied for.

Footnote

CODE OF FEDERAL REGULATIONS 21 § 807.65 Subpart D - Exemptions, Paragraphs (d) & (f)
Excludes and exempts from regulation:

"(d) Licensed practitioners, including physicians, dentists, and optometrists, who manufacture or otherwise alter devices solely for use in their practice."

"(f) Persons who manufacture, prepare, propagate, compound, or process devices solely for use in research, teaching, or analysis, and do not introduce such devices into commercial distribution."

Use of this device therefore appears legal and exempt from FDA regulations when you construct it yourself for research and / or use in your own practice 1 But double-check your local, county and state regulations for possible exceptions.

SUGGESTIONS FOR ACQUIRING AND USING AN INDUCTIVELY COUPLED MAGNETIC PULSE GENERATOR FOR THEORETICAL LYMPH AND TISSUE HIV NEUTRALIZATION

Revision 13 May, 1996 Copyright © 1991/1996 Robert C. Beck, D.Sc.

Note: These data are for informational and instructional purposes only and are not to be construed as medical advice. Consult with your licensed health practitioner.

In keeping with do-it-yourself inexpensive hypothetical approaches to self-help, the simplest and most rapid means for obtaining a capacitor-discharge magnetic pulse lymph and tissue pathogen neutralizer would be to find and modify a used functioning portable battery and ac powered electronic flash (strobe light) for cameras. These are acquired at swap meets, yard sales, pawn shops, or in junk boxes at used camera stores. Or purchase a new Vivitar (brand) model 1900 (\$22) carried at some professional camera stores. This compact, light weight, inexpensive, rapid recharging flash is only 17.5 watt-seconds power but is readily available and easily modified. It works well enough for casual use but runs on batteries only so has greater operating expense than an AC/DC unit.

California swap meet prices for used strobes range from \$4.00 to about \$18.00. One Sunday the writer found a dozen ac/dc strobes, all in good working condition. Carry four AA batteries with you so you can test flash units before purchasing. I chose to modify a long-discontinued Vivitar (brand) model 110 because it was larger than the rest and seemingly more powerful, however almost any brand or model of comparable output power (35 watt-seconds) should work. Preferably select one with 115V ac as well as battery operating (dc) capability.

First wind the applicator coil. Junk VHS videocassette reels are cheap, plentiful and adequate for this application. Remove 5 screws from shell, remove reels and discard tape. Be SURE alternative spools (if used) are non-conductive or system will not work. Avoid shorter length VHS tape reels which may have center hubs larger than 1" dia. and won't hold sufficient wire. Drill 1/4" holes through hub and through center of flange(s). Make two 4" discs from 1/4" thick plastic or stiff fiberboard, drill 1/4" center holes and another 1/4" hole off-center so coil's inside lead wire can be pulled through. These "stiffeners" will sandwich reel's flanges so they won't warp or split as wire pressure builds up while winding progresses. A 2" (or longer) 1/4-20 machine nut and bolt with washers through centers will clamp flange stiffeners and reel and also provide a shaft to hold in a variable speed drill motor or similar winding device if used. Then remove bolt and stiffeners.

Specifications: -130 turns #14 plain enamel insulated copper magnet wire wound onto -1" ID hub and -3-1/2" OD VHS spool with a gap width for wire of -5/8". Scrape enamel insulation 1/2" from end. Pull inside end of magnet wire through hub and stiffener and to outside. -130 turns (about three 1/2 LB rolls spliced together) should fill spool. Remove bolt, stiffeners, and finished coil. Now solder ends of 4 ft of heavy two-wire extension cord to each side of coil. Finished coil weighs -1 LB 3 oz, has -0.935 millihenry inductance, 0.34 Ω resistance, and takes -20 minutes to hand wind or -3 min. with drill motor. An excellent alternative is an AMS brand air-core crossover inductor for home audio, MCM Electronics, Centerville, OH 45459, (800) 543-4330 catalog # 50-940, #16 gauge, 0.58 Ω , 2.5mH, 2-7/8" dia., \$10.65

Strobe modification consists simply of wiring the finished applicator coil with 4' ft. leads in series between the flash tube and its storage capacitor. Be extremely cautious when working with case open because a strobe's capacitor can hold a residual high-voltage charge for a long time even when "off". Before modifying and to avoid shock, short out the capacitor by placing clip leads directly across the flash tube. Remember to remove this shunt later. To install coil, unsolder either wire from flash tube and connect one lead wire from coil to that side of tube. Connect the other lead from coil to the wire you just removed from tube. Insulate connections with tape. This places your coil in series with the flash tube and enables the tube to act as an ionized gas relay or "thyatron" that dumps most of capacitor's stored energy through coil when fired. Lamp will still flash but less brightly. Cover flash window with black paper. Replace case. You're done!

Is it working properly? A good way to test for strength of pulsed magnetic energy is to lay a thin steel washer (one strongly attracted to magnet) flat on top of coil, 1/2" off center. A 1" dia. "fender" washer with 1/8" center hole works well. Let the flash unit charge for about ten seconds plus or until the strobe's "ready light" comes on then push flash button and see how high the washer is "kicked" by Eddy current repulsion. A 35 watt-second strobe repels a washer about 14 inches vertically. Think of your pulsed coil as the "primary" of a transformer and anything conductive nearby (living tissue included) as the "secondary" into which current is induced when cut by coil's time-varying magnetic lines of flux. Your do-it-yourself magnetic pulse generator delivers a measurable output intensity several thousand times more powerful during each cycle than \$7,000.00 German "Magnetrons"®, Elecsystem "Biotrons"®, or Canada's "Centurion"® devices widely exhibited at holistic medical expos, none of which is nearly powerful enough for HIV, herpes, hepatitis or Epstein-Barr neutralization or adequate electroporation. It is also functionally similar to the "Diapulse"® miracle-working healing modality when coil is applied over liver and other organs. Regular permanent magnets no matter how powerful in Gauss absolutely will not work for this application regardless of claims since only a time varying field can induce a voltage in tissue. Magnetic fields and therefore induced currents penetrate all body cells, bones and tissues in proximity to coil (effective approx. 4 inches deep) and can theoretically neutralize electro-sensitive pathogens and viruses such as herpes B, HIV, hepatitis, Epstein-Barr and possibly many others as yet undiscovered that can hide within nerve sheaths and are therefore unloachable via immune system, white cells, or injectables. This may account for the impossibility of curing many known chronic infections via pharmaceuticals, antibiotics, or any presently known conventional treatments other than electrotherapy. Use pulser on body sites daily concurrently with blood clearing. This pulser is considered safe to use anywhere on the head, chest, and body except with cardiac pacemaker users. See pg 8 for lymph gland locations.

To use, press fully insulated coil flat against body over lymph glands and other selected locations such as shown on pg 8. Let strobe build up to full charge (about 4 to 10 seconds between pulses) and fire coil while pressing over each selected site. Subjects will feel no physical sensations except for light "thumps" during this phase of treatment. Exposure levels are considered safe because intensity of this magnetic pulser is much lower than Magnetic Nuclear Resonance Imaging in routine use on tens of thousands of patients. But should subject feel "headachy", nauseous, sluggish, or display flu-like symptoms after exposures with either of these devices, reduce number of pulses or duration of blood clearing process and drink more water. If immune system is very badly damaged, you may need to repeat all routines after several months to insure permanent and complete neutralization. When using, keep coil several feet away from credit cards, watches, magnetic tape, computers, floppy disks, homeopathic remedies, etc., since its powerful magnetic field can de-gauss and erase magnetic data as well as subtle energy potentiated medicines. As an unanticipated serendipity, pulsers are reported to erase deeply rooted lymph and tissue pathology and possibly even classical "miasmas" as well as many other microbes, fungi, bacteria, parasites, and viruses. Flash should preferably be used with ac power to save battery costs since you'll only get about 40 full pulses per new set of alkaline batteries. For sanitary purposes, enclose coil in plastic zip-lock sandwich bag discarded after each user. When treating numerous subjects if there's no ac adapter it is economical to purchase and utilize a small rechargeable 6V lead-acid "motorcycle" storage battery, or use rechargeable NiCads which easily pay for themselves but give fewer flashes per charge than Alkalines.

How much should this cost? Used electronic flash lamps cost - \$ 4.00 to - \$ 18.00. Three 1/2 LB spools of #14 magnet wire retail for \$9.66 ea. at Action Electronics. (You'll need -1-1/2 LB) 4-AA alkaline batteries, \$ 2.89. A 12 ft #14 X 2-wire 15 amp. ac extension cord costs about \$2. and makes 3 sets of leads, or use heavy-duty speaker wire. VHS spools -50¢. Wholesale wire from \$2.50 to \$4.35/ LB in 10 LB rolls at Pacific Wire & Cable, 1228 S Village Way, Santa Ana, CA 92704. (714) 558-1864 -1 week delivery. **-\$15. minimum / \$60.50 maximum.**

Masher" was revitalized and put to an infinitely higher use. He found that magnetic pulses in the range of 10,000 gauss not only "attenuated" the viruses, but it caused the sluggish lymph system to drain. This added benefit only made the body more able to remove the neutralized pathogens quickly. Protocols include 3 to 5 pulses at each location, each day.

The so called "Beck Zapper" has two electrodes that are applied to the body at locations where the arterial blood flow is close to the surface of the skin, like at the wrists or ankles. Bi-phasic (not square wave) electric currents up to 2 milliamperes are conducted across the skin, into the blood, and back out through the skin at the other electrode. Protocols vary from 20 minutes to 2 hours a day, depending on the severity of the condition.

Bob has given me permission to re-print his plans and parts lists for these devices to continue their ubiquitous spread into the public domain. Meanwhile, various manufacturers are making devices, that perform these functions, available to the public, ready to use. The magnetic pulse devices range from a coil attached to a rebuilt photo-flash unit that produces about 1 pulse every 10 seconds to very sophisticated, professional units that pulse over 30 times a second. Prices range from \$200 to \$500. "Beck Zappers" come with a wide range of features and electrode styles. Look for features like easy battery access, self-adhesive electrodes, carrying case, etc. Prices range from \$200 to \$350. All of these units work, including the very simple units made from the plans in this article. For people who want this technology on a budget, the low cost units work fine. The higher priced units are still inexpensive when compared to other types of equipment, (like "Rife Frequency Generators" sic..) and are worth the extra cost because of their ease of use, refined presentation, and augmented gentleness. Even people with extreme subtle energy sensitivities can use the more expensive units with little or no side-effects. Partially assembled kits are also available by calling Concept 2000 at (303) 413-0345.

Dr. Beck's third contribution was the publishing of plans, starting in 1994, for the inexpensive manufacture of colloidal silver at home. Colloidal silver is the most effective, broad-spectrum germicide known in medicine. It can kill more than 650 different kinds of micro-organisms. It kills ALL viruses (including HIV), MOST bacteria (including salmonella), ALL fungi (including candida albicans) and ALL single-celled parasites (like giardia). When made correctly, it is totally non-toxic to higher life forms. In the health food stores, colloidal silver costs between \$8 and \$13 an ounce. With a simple, low voltage electrolysis of water using pure silver electrodes, colloidal silver may be made at home for a few pennies an ounce. There are a number of manufacturers of kits and devices for this purpose on the market now. All of them learned how to do it from Dr. Beck's published papers.

When made correctly, colloidal silver will be either totally clear or a transparent yellow color. This appearance is the simplest way to correctly determine that the size of the silver particles is below 0.015 microns in diameter. Any colloidal silver

that is cloudy white, gray or silver in appearance indicates a particle size of about 0.1 microns in diameter. When shopping for one of these devices, make sure it can make the "transparent yellow stuff". Plans cost about \$5. Kits range in cost from \$25 to \$40. Finished units range in cost from \$75 to \$100. Replacement pure silver electrodes range from \$10 to \$20 a set.

If you have not checked out colloidal silver yet, definitely do it. Colloidal silver has thousands of home uses and should be in everyone's First-Aid kit. It soothes burns, speeds wound healing and disinfects all types of surfaces. It is non-toxic and safe for use on even sensitive tissues like nasal passages or in the eyes. Thousands of case histories show it has even been effective against cancer (remember, R.R.Rife said cancer was a virus). At a penny a teaspoon, you can afford to use it every day.

I have often told associates that the only way we will ever get out from under the control of the monopoly interests in Medicine and energy production, is for the inventors of the world to GIVE AWAY a few TRILLION dollars worth of discoveries into the public domain. Dr. Robert C. Beck has lead the way and I challenge hundreds of others to follow his example. This is a crusade that must not stop until ALL OF HUMANITY IS FREE OF DISEASE!

Another outrageous development is the appearance on audio and video of the lecture, *Dead Doctors Don't Lie* by Joel Wallach, DVM, ND. Thousands and thousands of copies of this tape are in circulation. I, personally, have received 3 unsolicited copies in the mail. In the lecture, Dr. Wallach makes some startling revelations. The most profound of these is "every animal or human that dies of 'natural causes' dies of a nutritional deficiency." The lecture goes on for over an hour and a half, detailing which degenerative conditions are related to which nutritional deficiencies, and how to reverse or prevent them.

Two of the examples he gives are diabetes and arthritis, conditions that affect millions of people worldwide. Diabetes, type II, can be prevented or reversed by taking the two trace elements chromium and vanadium. The medical community has already announced that Chromium can be helpful to diabetics. But the Medical studies show that to take people off insulin and reverse the condition completely, the underlying Vanadium deficiency must also be addressed. This regime also works for other blood sugar imbalances like hypoglycemia. I was particularly interested in this information because diabetes, type II, runs in my family, and last year I fell asleep while driving my car in the middle of the afternoon. It was a short nap! I "totaled" the car, but escaped unhurt. I found an excellent product called "Diatrol" that has chelated chromium and chelated vanadium in it. After two weeks on this product, my tendency to "crash" in the afternoon was dramatically reduced. My father is currently controlling his diabetic symptoms with a dietary regime that includes chromium, vanadium, and his doctor's supervision.

According to Dr. Wallach, Arthritis, in all of its forms, is a Calcium deficiency. He sites published studies done at Harvard Medical School where even joint crippling Arthritis was re-

versed and healed with "one heaping teaspoon of ground-up chicken cartilage each morning with their orange juice" taken for a period of 90 days. He gives a recipe for what he calls his "Pig Arthritis Formula" which includes: 8 ounces of calcium fortified orange juice, stir in 2 ounces of colloidal minerals (more on this in a minute) and two ¼ ounce packets of Knox Gelatin, twice a day for 3 months. Does it work? Well, for the last 10 years I have had periodic pain in my hip joints, as well as chronically stiff and sore muscles in my back. For a long time I did not want to admit it, but these are among the classic symptoms of rheumatoid arthritis. I started on Dr. Wallach's "Pig Arthritis Formula" and within a very short time these symptoms disappeared.

The lecture was originally produced as a marketing piece for Eagle Investments, a network marketing company. The product they are promoting on the tape is a suspension of 77 different colloidal minerals in spring water. This product is made by grinding up pre-historic plant material (humic shale) from a deposit in Emory, Utah, and soaking it in spring water for about 3 weeks. The plant material is then strained off and the suspended colloidal minerals remain in the water. Since 1926 it has been marketed under many names that include "Body Toddy", "Mineral Toddy", "Body Booster Minerals", "Colloidal Minerals" and many other names. This product is awesome, and it changes peoples lives. Remarkably, no one ever figured out how to successfully market this stuff until Dr. Joel Wallach entered the picture. There are currently a growing number of network marketing and direct sales companies selling this product. Prices range from \$12 to \$30 per quart. This single product is capable of making up ALL of your trace mineral deficiencies. We will all need to supplement our diets with a product like this until "Rock Dust" farming practices sufficiently re-mineralize the farm soils of the world.

Most vitamin and mineral supplement products on the market offer their nutrients in a form that is NOT available for our bodies to metabolize. The very best supplements are called "food based" or "FoodForm[®]" vitamins and minerals. For instance, most of us have a calcium deficiency, to one degree or another. The best calcium supplement product I have found is FoodForm[®] Bone Nourisher. It not only provides calcium in a 100% bio-available form, it provides all of the co-factors our bodies need to metabolize and retain calcium, including magnesium, boron, copper, and others, delivered in a complex food matrix. FoodForm[®] products are harder and harder to find because they do not have the UPC Barcode on the bottle. So, hunt around, its worth it!

To summarize, all of the information, products, and technology exist TODAY to eliminate ALL DISEASES related to infectious germs and nutritional deficiencies. Get fully informed about these revolutionary discoveries and take advantage of them in YOUR LIFE. I have purposefully NOT mentioned brand names or sources, so none of these products will be found in violation of the Federal Disapproval Agency. So, its up to you. Take some responsibility, go out and find these products, books, and devices so next year, you can really be healthier than you have ever been before. ■

Resonant Frequency Therapy

Building the Rife Beam Ray Device

By James E. Bare, DC

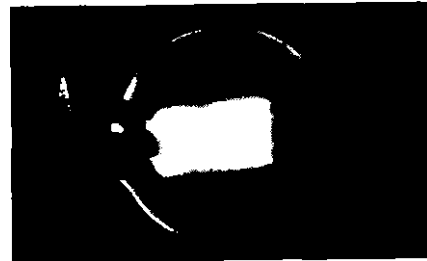

This groundbreaking book includes a complete set of instructions on the construction of a modern version of the Rife Beam Ray Device. Also included is a list of components with directions on how to obtain, modify, and assemble them to create a fully functioning Beam Ray Device.

"If you are interested in Rife's work...drop what you are doing and buy this book!" – Peter Lindemann

Now available from:
 Borderland Sciences Research Foundation
 P.O. Box 220, Bayside, CA 95524
 (707) 825-7733
 #B0344 Resonant Frequency Therapy...\$25.00

Bio-Power

Energy Accumulator

A miniaturized energy accumulator based on the energy experiments of Dr. Wilhelm Reich.

This small orgone shooter is made of wood turned on a lathe encompassing several layers of cork and steel wool.

PRICE: \$139.50

Available from:

AAAPSCO
 3592 Main St.,
 Lemon Grove, CA 91945
 (619) 460-1020

*A \$20.00 refund is offered by AAAPSCO upon the receipt of any completed test results (e.g. experiments on plant growth).

For research purposes only.

THE BORDERLAND EXPERIMENTER

EXPERIMENT: PLANTS AND RADIONIC CURRENTS

by Charles Allon

INTRODUCTION

Plants are in a state of absolute fusion with their environment. When connected to audio monitors, plants behave as extremely sensitive thermal, barometric, hydrologic, chemical, and electromagnetic sensors. Responding to every nuance of natural expression, plants are sensory beings whose capacity exceeds the expectations of orthodox science.

Plants respond to energetic applications not normally detected in conventional measuring devices. Because plants are living things, they are privy to biodynamic vectors which do not resolve into combinations of simple inert forces. In well controlled settings, plants evidence responses which are remarkably complex. In these responses, plants reveal themselves as far more developed beings than orthodox botany leads us to believe.

While the experiential content of plant life cannot be affirmed through any objective means, we do find evidence of their strong response to biodynamic stimuli which human beings do not normally sense. Observing that the application of ground currents to houseplants evoked mysterious audio fluctuations, we began to perform an interesting group of experiments last spring. In these, I believe you will find proof of the objective foundation supporting Radionic Science.

Botanists observe the absorptive-assimilative process in plants and erroneously equate these with the life of plants. They are sure that the nutritive requirements of plants are limited to mineral waters, carbon dioxide, and sunlight. Believing that plant life is the sum of these nutrients, orthodox botanists reject any experimental evidence of life organizing energies. The existence of such a "vitalizing energy" would displace these "nutritive requirements" from their modern place as "first cause", the latter being relegated to mere effects.

Modern Biology over quotes the phrase "life comes from life", meaning by this that cellular reproduction is the generative agency in all life forms. It is for this reason that botanists believe that cellular absorptions and assimilations represent interactive processes which, in the absence of additional material, should operate continuously. The concept which cites cellular activity and cellular momentum as the life generative principle fails in several instances. Most obviously, such cellular momentum fails to explain the death process. Dr. Jagadis Bose showed that when plants are separated from their familiar grounds, they go into a state of "shock", some eventually dying.

To continue with a little history, let us look at some of the most intriguing experiments which have shown the intimate relationship plants have with the vital energy of ground currents. Dr. George Starr White was one of the first to experiment with ground rods and

plants. Running copper wires from a grounded copper rod into a series of potted plants, Dr. White found that this simple arrangement greatly stimulated the life processes of his test plants. Wired plants grew taller and flourished. It was remarked that these plants produced better foliage, more beautiful flowers, and more succulent fruit.

In addition, Dr. White dug irrigation ditches along tree rows, driving in 6 foot iron posts into the ditch every 15 feet. Thick copper wire was run between each of these ground rods and buried at a depth of 2 feet. This wire was pinched up underneath the root system of each tree and connected to the next ground rod of the sequence. In this way, all of the trees in a row were grounded through the copper wire. Plants in their natural setting receive a fixed ground current supply directly through their root systems. Dr. White, in his early investigations, established that metal grounds enhanced the life force in plants. His early experiments with natural earth currents revealed that plants need specific ground currents by which their life force is greatly magnified.

These remarkable results became the foundation of a new horticultural science. Dr. White adopted the method of wiring all kinds of plants to deep ground rods, discovering enormous improvements over traditional chemical manipulations. To improve the quality and strength of trees, for example, Dr. White placed single coils of 1 inch iron mesh completely around the trunks. Secured at a depth of four inches within the soil, these grounded coils stimulated the production of stronger and more fruitful trees. Dr. White tied plates of tin to the upper branches of his fruit trees, discovering that this procedure greatly increased the ground drawn effects. He eventually found that the storage of seeds in grounded iron boxes stimulated germination with an unprecedented vigor. His work in therapeutic applications of these discoveries had already been demonstrated.

Georges Lahovsky later made contributions in this new and exciting field of study, focussing all of his attentions on the effect of resonant loop therapies. Placing opened metallic loops a few inches off the ground around plants, he found that plants which suffered from various ailments were suddenly and completely cured. Eliminating the need for most of the insecticides and other chemical poisons normally applied in such instances, Lahovsky pioneered a natural method of medical therapy in human subjects. Long before he conceived of the multiple wave oscillator, a device which irritates its subjects with an electrostatic barrage, he worked with the naturopathic energies of these "open circuit" loops.

Plants absorb gases and mineral waters only because they are biodynamically activated by an external energy. These studies and others show that plants function because they first absorb radionic

currents from the ground and from space. Vegetative life functions all but cease in the absence of radionic currents. In this vantage, we study the processes which precede plant metabolism. Indeed, we will learn that the radionic earth currents comprise the fundamental nutritive need of plants. We will therefore focus attention on the energetic precursors to plant life, the radionic currents which raise vegetative forms up from mineral matter. In this series of experiments, we will use plants as objective detectors of subjective energies. Plants themselves will prove the objective reality of radionic ground currents.

DETERMINING THE RADIONIC SELECTIVITY OF PLANTS

MATERIALS:

- 1 or more Micronta Biosensors (Radio Shack)*
- 2 Extension wires with soldered copper electrodes
- Several plants
- Large plastic drinking cups
- Ringstand with rubberized clamp
- 1 - 2" C-clamp
- Copper ground rod
- Several stage variable capacitor (medium to large volume)
- Long extension wires
- Wire stripper

PREPARATIONS

Although my last article contained some of this preliminary information, many have requested further elucidation on the preparatory methods necessary for these experiments.

You will need to obtain several Biosensor devices for comparative studies among plants (see editor's note). The Biosensor changes galvanic skin response to audio fluctuations. Once you make the necessary modifications on your Biosensors for plant experiments, they will not be very useful for personal biofeedback readings.

For plant experiments, the electrodes must be well exposed and unencumbered. There are several ways to contact the leaf tissue, but by far the best means uses the stainless steel electrodes in the finger pads. To expose them completely for plant experiments, carefully clip the Velcro bands around the electrodes. **DO NOT CUT** the lead wires at any point! Carefully trim away the material around the electrodes.

The ringstand you have chosen **MUST** be equipped with rubberized clamps if you are going to use the clamps to attach directly to the electrodes. These will hold the electrodes to the plant leaves without shorting out the Biosensor. The best way to attach the electrodes to the plant is with a small two inch C-clamp. This clamp will fit snugly in the clamp of the ringstand and will provide for

* *Editor's note: Unfortunately, Radio Shack has discontinued production of the Micronta Biosensor unit. A very good \$150 unit developed by Beryl Payne may be obtained from PsychoPhysics Labs, 4264 Topsail Ct., Soquel, CA 95073 - Ph. (408) 462-1588. For those who would like to build it themselves, a more sophisticated instrument designed specifically for use with plants is detailed in the article, "Detecting Biodynamic Signals" on page 49.*

greater ease of applying the sensitive amounts of pressure required by the electrodes. You will need to insulate the contact points of the C-clamp from the electrodes, and this can be done with any type of cloth tape.

Another means by which we may contact plant tissue requires two small copper alligator clips (obtained from Radio Shack) and two extension wires. Simply clip off the electrodes and solder the wires to the Biosensor leads. Then solder the clips to the ends of these extension leads. Cover the solder points with electrical tape. These clips must be closely placed side by side on the leaf. This method contacts plant sensitivities along the veins of the plant, and always requires a higher gain setting before the audio signals register. While this is not the most preferred contact format, it does permit certain other freedoms. When contacting leaf tissue with alligator clips, one must make absolutely sure that the leads cannot and do not move! The leads must be supported against gravity. Any movement will invalidate your findings.

You may wish to use several plants for the experiment. Select different varieties. These may be purchased or, better yet, taken from the ground nearby. Wildflowers have proven to be excellent specimens for these experiments. I have found that large plastic cups serve well as insulated containers. Place your plants in these if you have decided to use wildflowers. Water the leaves and roots well, and allow at least a week for the plant to acclimate to its new home.

As we are going to implement energies from a ground source, make sure you set up your experimental arrangement near the source of your choice. If you have chosen to use a ground rod, make sure that there is a window which can access the long lead wire. Set the arrangement on a sturdy table with adequate access to the lead wire from ground. Several of our readers may not have the necessary proximity to ground which they would like. In some cases, an ordinary water faucet ground has been found to be equally effective. Cold water pipes are good sources of ground currents.

Loop the stripped end of a long wire to either your ground rod or the cold tap of your kitchen sink. Make sure there is enough stripped metal surface in contact with your ground source. If you use a ground rod, try using a copper conduit pipe. These can be obtained for a few dollars in any hardware store. Get a 2 foot section. Wet the ground you have chosen for your site. Wearing gloves, carefully drive the pipe into the ground until about 9 inches remain above the surface. Strip the free end of your lead wire and wrap this wire around the pipe. Use electrical tape to hold the wire firmly in place.

If you are using a kitchen sink, simply strip the free end of a wire and wrap it around the base of the cold water tap. Wrap with rubber tape and draw the wire up to your experimental arrangement. You are now ready to begin the experiments.

EXPERIMENT 1

Before we begin to use our plants, or attach the tuning capacitor, there are several key items with which you should become experientially familiar. The ground line is electrically neutral. Electrical measuring instruments require two comparative connection points. We cannot measure or define an electrical potential from this monopolar wire, since this procedure requires another ground reference. Using two copper ground rods or two cold water pipes results in electrical zero readings. One might as well connect a

galvanometer to itself!

The energy is not electrical. Neither is it electrostatic. Tests with electroscopes do not show any deflection. In addition, those who declare these currents are produced by either powerlines or radio signals will be disappointed! It has been found that these energies flow through components which rectify all such electrical currents. Electrically neutral wires, prepared to exclude all interferences, stimulate surprisingly powerful responses in biomonitored plants. Therefore, the grounded wire is electrically neutral but is not energetically neutral.

Ground currents have certain characteristics which differ completely from those of electrical currents. Electricity will flow between any two points of different potential. Ground currents will not always flow between two points of differing electrical potential. Ground currents are biodynamic currents, one of whose attributes consists of patterns. Ground currents will flow only when a capacity to absorb certain patterns is present. In the absence of these patterns, no current will flow. Hence, no current may initially be detected or sensed. It is the "pattern demand" which stimulates the flow of ground currents — an attribute not shared by electrical currents.

Each person has specific "pattern demands" for radionic currents. This is evidence of differences in human condition, not evidence that radionic currents do not objectively exist! There are those who do not comprehend how an energized line can produce no effect in certain people. Radionic ground currents are potentials which must find capacities for their patterns in order to flow. If the proper pattern demanding capacities are present in us, then we will feel the energy. If these pattern demanding capacities are not present within us, no radionic energy will flow and we will feel nothing. The line will appear to be "dead". But this does not mean that we are insensitive, or that radionic energy does not exist!

Whether you have or do not have a pattern demand which the ground line can supply has nothing to do with your own sensitivity or the existence of radionic energy. These are unique to individuals and represent nutritive differences. Many of our food preferences actually come from a deeper nutritive need. It is the same with radionic currents in the ground. The selection process represents a deep truth which has rarely been examined.

Hold the wire in either hand. Relax and notice what you are sensing. Can you feel the energy? Some sensitive persons can. This energy is not disagreeable. It is in fact vitalizing. Hence the name "Vital Energy". Some feel this influence as a tingling in the fingers and arm. Some feel it as a heat. There are other effects, those which involve our higher states of awareness, but these visceral sensations will now suffice in discussion. With certain persons, these sensations will penetrate the thorax or abdomen quite strongly. If you are feeling or sensing the energetic flow, you are observing the action of a personal "selection process". Your body is selectively absorbing a certain radionic current from the supply. This is why YOU feel its presence.

But the sensations differ among experimenters. You may not feel a thing, and this is certainly not your "fault" or "inability". It is simply indicative of the fact that YOUR body is not selecting any of the radionic currents from the ground supply at that moment. It is because your body has not selected a radionic current from the supply that you feel nothing. These demands are autonomic, having nothing to do with will power, concentration, talent, or self worth.

They simply indicate the differences in our personal organization. Do not hastily conclude that the energy does not exist, or that the line is incapable of delivering energies for our experiments with plants. Worse, you should not conclude that the energy requires your mind, or that it is a self-produced effect. These are some of the fatal flaws which orthodox science have historically made.

Wide differences always exist among wide varieties of people who test for radionic currents. The reason for these wide variations has to do with personal selectivity. The specific currents which our bodies demand and receive do not always coincide with those experienced by others. Hence the differences in "tingling", "heat", etc. sensations. Each effect is actually caused by a different vitalizing current, the direct result of autonomic personal pattern demands.

The fact that there are such selective differences among people represents yet another phenomenon which should provoke our curiosity. Why do some people not select specific sensible currents from the ground supply? Why do others select sensible currents? What do these manifestations teach us about our different body needs? All of this has to do with our individual differences. This fact leads us to add phenomena, not eliminate them, when compiling data in Qualitative Science.

EXPERIMENT 2

In the first experiment, you have already learned a fact which has troubled orthodox science for over two centuries. The fact that only certain persons were able to detect the vital currents caused the academicians to invalidate the existence of vital energy. The addition of a variable capacitor to the ground wire brings an aspect of tuning into our experiment not present in the first experiment. The variable capacitor stimulates the appearance of currents which may not have moved through direct body contact alone. We may think of the variable capacitor as a pattern demand which exceeds those within our own bodies. The variable capacitor thus reaches into the ground supply and stimulates the upwelling of currents which respond to its pattern demands. These new currents were not present when you simply held the wire in your hand.

The parts list does not require any specific variable capacitor, simply because any medium to large volume multivane rotor will suffice. These are inexpensive, and can be readily obtained through several companies (Antique Electronics 1-602-820-5411 or Fair Radio 1-419-223-2196). Buy several different sizes if you can. These will each produce their specific pattern drawing results, a phenomenon which itself requires deep study. With the use of the variable capacitor we are effectively increasing the supply of special pattern currents. This increases the possibility that you may now feel them, had you not previously.

Locate the terminal which connects with the STATOR plates of your variable capacitor. This is always an insulated terminal on the side of the frame. Connect the ground wire to this insulated terminal. Ground energy enters the stator and floods the capacitor gaps. We want to introduce new pattern capacity to this incoming flow. Turning the rotor achieves this condition. The resulting currents must be withdrawn from the capacitor. Connect a thin wire lead 6 feet in length directly to the frame of the capacitor. It is important to use a thin wire here, since we will disconnect this wire during certain experiments, and we do not wish to move the plants at all. Thick wire leads prove too unmanageable for delicate movements.

The variable capacitor and its long thin lead wire is the tunable energy source for your experiments. Flowing across and through the vane spaces in their own distributed patterns, each current will manifest its maximum flow at a specific rotor position. When you turn the rotor, you are now selecting specific radionic currents, some of which you may feel with a special vitalizing force. Open the rotor completely. Hold the wire in your right hand. Now slowly turn the rotor until you feel the current. Note those positions on the rotor where you have sensed the energizing current. You may wish to use a protractor in order to write the degree of turn at which you felt the effect. This process is like the application of Radionic Energy in therapy, a topic of greatest interest and need today.

The conventional attitude, including those who hold to the "psychotronics" theory, is that the reception of these energizing currents is a completely subjective phenomena. Through the use of your plant sensors, you are about to discover that Radionic Currents are objective and real. In their autonomic demand for radionic currents, plants are no different than ourselves. The demand for these currents is the demand for life-giving energy, a vitalizing flow which revivifies the entire physiology through contact. Note the very form and symmetry of the autonomic nervous system. Does it not resemble the complex weave of vines or roots? In our autonomic demands we are very vegetative in process.

More fundamentally, this demonstration upsets several conventional theoretical foundations. Having connected the plants through a variable capacitor, we have greatly complicated the "electrical" view of vital energies for obvious reasons. How does this energy flow through the space gaps between the vanes? Those who reduce these influences to electrostatic fields or high frequency currents are soon baffled by the experimental conditions imposed on this simple system. Placing resistors and blocking diodes in line with ground demonstrably breaks any radio energy which may find itself into the line. Nevertheless, the radionic energies continue flowing.

EXPERIMENT 3

Leave the rotor completely opened now. You are now ready for the second phase of our experiments. We will now connect your plants with the ground source. Draw the thin six foot lead wire from your tuning capacitor, keeping the capacitor far from the plants which you will examine. It is IMPERATIVE that the plants be kept at a good distance from the tuning capacitor. Certain effects we will want to elicit require that this separation distance be maintained. Place one of your plants on one side of the ringstand. Select a leaf. Place the electrodes on opposite sides of the leaf and slip this arrangement into the C-clamp jaws. Carefully close the clamp around the electrodes. Gently adjust the pressure while tightening the clamp. Be careful NOT TO PIERCE THE LEAF TISSUE!

Turn on the Biosensor and adjust the sensitivity knob. Slowly turn the dial until a steady tone is obtained. You will note that the responses are erratic, either pitching down or up. You want to balance this tone until it remains constant. Do you hear the "plant songs"? Unattended, this plant is crying out to the environment. In natural settings, these sounds cannot be heard, as they are vitalistic signals.

Remember, these audio signals are not electrical in their primary state. It is the interaction of the Biosensor current with this vital plant energy which produces the undulations. Listen and observe the

wandering of the plant song until you have grown accustomed to the sound.

Now take the wire lead from your variable capacitor, the very same lead which you grasped in our second experiment. Drive the free end of your lead wire directly INTO THE ROOT SYSTEM of your plant. You have before you a most remarkable "triode", the plant acting as an exchange medium between vitalistic energies and the audio signalling device. In this, we have actually devised an objective instrument for the detection of otherwise subjective energies. Begin with the capacitor in the "opened" position. Reestablish your audio baseline by adjusting the sensitivity on your Biosensor. Let the plant become accustomed to the new condition. If you have two plants connected at the same time to different Biosensors, you can compare the audio differences produced by an unattached plant and this new attached state.

The plant may actually begin its wild fluctuations with the first placement of the wire. This means that the opened capacitor position has successfully drawn in a pattern which the plant has demanded. We can begin our search now. Very gradually close the vanes. Gradual movement is the key in this experiment, since plants are not "on-off switches". Being living systems, they require time to respond. Plant responses always reveal a latency period just before and after their audio response. In turning the dial slowly you will hear several pitch "stutters". Each represents a radionic current which the capacitor has entuned. Listen for these obvious audio changes. Whenever you hear an audio "stutter", you have "located" a current. These experiments objectively prove the reality of radionic instrumentation and points at which specific radionic currents seem clustered.

In their highly developed and behavioral responses to radionic currents, plants evidence a complexity which requires developed neurological structures, yet we cannot detect a real structure of such complexity. Dr. Bose believed he had indeed found these structures in various plants. The plant will demonstrate a demand capacity at one, two, or even three points. Of these few settings, one will always exceed the others in reactivity. This will then be the major radionic current required and demanded by the plant. This one setting brings to the plant its primary nutritive need. Flanking this major setting, or "fundamental", there will be a spectrum of weak reactions, or "harmonics". There are always several minor reactive points. Note each of these, writing them down for reference. Test each plant and mark the radionic positions which each requires.

The plant may not absorb every one of these currents from the capacitor, merely stuttering for a fraction of a second when the current strikes into the plant tissue. Nevertheless, wait and listen for a few seconds at each "stutter point". These may gradually develop into a prolonged audio fluctuation. All of the stutter points which produce these prolonged fluctuations should be marked on a reference sheet. Try lots of different plants over the next few weeks. See if you can collate the varieties and their radionic clusters. Do these current points drift? Do they change radically? How do these alterations correspond with plant vitality? Do the appearance of flowers modify the radionic settings?

EXPERIMENT 4

The simple tuning system which we have been using permits the manifestation of other fascinating characteristics. Radionic ground

currents will flow in either of two directions in a ground rod. Certain tuned currents come out of the capacitor, as demanded by the plant. These produce rising audio pitches. Certain other currents however are drawn from the room into the capacitor and down into the ground. In these strange instances, it is the ground which has demanded a specific pattern current! These downwelling currents produce decreasing audio pitches. Through these phenomena we glimpse the mysterious subterranean world and its constant trafficking of messages, an unsuspected world of communications and languages unknown to humankind.

Therefore, we find points from which currents emerge and points into which patterns will flow. Because of this difference in current direction, there will be different kinds of audio fluctuations with which you will soon become familiar. Audio responses differ from point to point on the variable capacitor, marking emergent currents which the plant rejects or demands.

When you now locate points on the dial which produce decreasing audio pitches, you know that the plant is sending its pattern currents back into the ground. These "relaxation points", where the radionic currents are moving from plant to ground, reveal that currents are actually being drawn from space through the plant INTO the ground! Plants provide pathways for those wondrous currents which flow down from space and enter the ground. Other currents flow out of the ground. In this we also glimpse an unsuspected energetic topography, that which formed the very core of Geomancy. The radionics pioneer, T. G. Hieronymus, appreciated this fact, having designed special "cosmic pipes" for the powerful entunement of radionic currents from space. These were found to greatly increase the fertility of fields, furthering that new horticultural science earlier produced by Dr. White.

Having slowly swept through the dial, you now should have several current points and their characteristics. Marking the major and minor currents, as well as noting the current directions, will give you the radionic profile of the plant which you have just examined. List all of these and preserve the data with dates and times. These will prove to be of inestimable importance in later experimental determinations.

EXPERIMENT 5

Tuned currents which the plant absolutely demands will result in an audio "thrill response". These are noted by both steady "warbling songs" and sudden audio pitch INCREASES. In certain cases, this pitch increase will quickly reach inaudible levels. When this occurs, you have found a major current demanded by the plant. Experimental familiarity will now allow you to expand your knowledge of these things. Obtain a great number of plants, with the goal of individually listing and collating their various radionic settings.

It was for this reason that I suggested that you obtain ordinary wildflowers. They are plentiful and free! Wildflowers are very hearty and stand up under the shock induced by Biosensors. Some experimenters prefer to purchase plants for their demonstrations. The essential thing is that you obtain a sizable collection of plants. Number each one with a felt-tip marker and keep track of their progress. Keep good notes. Your notebook represents an important document in the re-emerging Qualitative Science.

EXPERIMENT 6

That plants will actively demand certain radionic currents may be shown by locating a major current point, and then carefully disconnecting the wire which leads from the capacitor to the plant. Disconnect it FROM THE CAPACITOR FRAME without moving the plant at all. The plant will at once produce a continual "wailing" song, which is really a distress signal. In this, you are observing an appetite demand which will not cease until you have reconnected the plant to its source. Reattaching the capacitor to the plant restores its warbling response once again.

Test other current points in this manner. If your tuner is positioned to draw in a major current, then the plant will respond violently when the wire is withdrawn. Make sure you do not move the plant while disconnecting. Movements will shake the wired leaf and will provoke unwarranted audio fluctuations. The removed connection will provoke either an upward "shriek" or a downward "sigh". In one case, a plant shrieked in such a loud and dramatic manner that I was compelled to reconnect it! When this was done, the plant calmed down and began to "sing".

EXPERIMENT 7

It is important to recognize that radionic currents are conducted only at certain rotor positions. This FIXED REFERENCE is enormous in its implications. Having slowly moved the vanes in a continuous sweep, you have found fixed points. That these few fixed points hold their place for each test plant has devastating impact on those who claim the "subjective" or "mental" view of Radionic Science. If these tuning systems were truly "psychotronic" in nature, then the rotor settings would not retain their fixed position regardless of time.

It is also quite impossible to recall these settings when testing a great number of plants, so that the reappearance of fixed settings becomes an obvious indication of their objective reality. The objective existence of both radionic currents and the validity of material tuning systems is thus proven. Test these rotor positions several hours or days later. It matters not. You will find that they "hold" in time irregardless of your subjective participation. These fixed points at which radionic currents are passed by the variable capacitor to the plant, prove their OBJECTIVE EXISTENCE.

EXPERIMENT 8

If you have performed the outlined experiments, you have already found that the same currents are not shared by all plants. Two plants will respond to two very different capacitor settings. This central fact allows that both currents and plants may be categorized. But now we can compare the radionic demands of 2 or more plants simultaneously, a most fascinating study.

First open the rotor on your variable capacitor completely. Always begin your examinations from this position. The use of multiple Biosensors permits simultaneous examination of plant songs. Start with 2 plants. Cut a second 6 foot length of thin wire, stripping and attaching its free end to the capacitor frame. Two wire leads should now be attached together at their source. Strip the free end of this second lead wire and drive it into the root system of your second plant. Separate each plant now. They should be perhaps a foot or more apart. Bring this second plant to the opposite side of the ringstand and carefully repeat the leaf clamp procedure.

Each plant should have a selected leaf wired to its own Biosensor. The simultaneous comparison of radionic differences between each of these plants can now be heard. Turn the Biosensors on and carefully adjust the gain until audio baselines have been established for each plant. Neither rising nor descending, audio baseline pitch may gently drift or simply level off. In a short time, the plant song makes itself heard. Once done, stand back and listen! The entire spectacle is a mystifying wonder, as supposed inanimate plants begin singing and filling the air in a strange otherworldly duet. Each plant is now connected by the roots to the tuning capacitor and will reveal energies which conventional science does not acknowledge.

Stimulated by the vitalizing energies, our own previous personal experience of these energies gives us a fair understanding of what the plants are experiencing. Unable themselves to elucidate on what they are experiencing, we remain limited to the observation of audio pitch changes made as a by-product of their experiential process. A variety of test plants provides the very best demonstration that a spectrum of radionic currents coexist in the ground. It is remarkable that these currents, mutually coexisting, do not interfere with one another. Nevertheless, these currents enter into the vanes of the variable capacitor and discharge across their gaps when appropriate pattern capacities exist at the receiving end. First become familiar with the general audio pattern which both plants are combining to produce. Once familiar with this background sound, you will immediately notice any slight deviations — the hallmark of an outside influence.

Each plant will now demand its own radionic currents from the same variable capacitor. Here is where the significant differences will be heard. Placed a foot apart on either side of this ringstand arrangement, each plant is separately connected with the tuning capacitor. Plant 1 will begin singing its characteristic "song" only at specified points. The same will be found of Plant 2. This experiment is perhaps the best indication that variable capacitors draw up different radionic currents from the ground, and that each plant demands its own currents.

Now very slowly turn the dial from its opened position. Find a point where one of the plant songs suddenly becomes noticeably modified. You will hear this against the familiar background as a sudden and obvious pitch rise, descent, or erratic fluctuation. As you turn the dial ever so slowly, you will notice that one plant will "turn on" while the other plant "turns off". Notice the selectivity with which each plant differentiates itself! If you had already collated the free radionic settings of each plant, you can compare and hear whether these settings have been modified by the simple placement of the two on a single tunable supply.

SUMMARY

The rich suite of responses with which plants make their utterances is the very basis of many new efforts in Qualitative Science. Validating the controversial aspects of Qualitative Science has now become a priority interest — that priority focussing on Radionics. There may be many whose long and strident belief concerning Radionics has been brought to an abrupt end. Those who are confident that Radionic Currents do not exist, or more specifically, that these currents are products of the mind alone, are shown to be in error.

The "psychotronics" camp has too long attempted the elimina-

tion of external energetic controllers — the biodynamic currents. That which the psychotronics view believes are unnecessary props and artifacts, now become the precious components of a New Technology.

In connecting plants directly to the ground by means of wires, we discover the objective reality of radionic currents. We have proven that these currents are non-electrical, differ among plants, serve as a nutritive need of plants, remain fixed in time, and enhance new responses which cannot be resolved by conventional analysis.

Plants are not autonomous entities. Certainly, botanists do not accept the fact that plants have developed nervous systems. Perhaps they should include the phrase "detectable nervous system". Perhaps certain living things do not require physiological nervous systems when their sensing body is incorporeal. ■

Plant Research Books From BORDERLANDS

THE SECRET LIFE OF PLANTS

by Peter Tompkins and Christopher Bird.

#B0332, 402pp, paperback, ... \$15.00

PLANETARY INFLUENCES UPON PLANTS

by Ernst Michael Kranich. #B0329, 184pp, paperback, ... \$12.95

PERSONALITY OF PLANTS

by Royal Dixon and Franklyn Fitch. #B0328, 221pp, ... \$15.95

PLANT RESPONSE

by Jagadis Chunder Bose (1906).

#B0341, 779pp, Illustrated, ... \$49.95

THE LIFE AND WORK OF SIR JAGADIS C. BOSE

by Patrick Geddes, 1920. #B0119, 259 pp, illustrated ... \$20.95

PLANT AUTOGRAPHS AND THEIR REVELATIONS

Sir Jagadis Chunder Bose, 1927.

#B0120, 120 illustrations, 240pp, staples ... \$19.95

MAN, MOON AND PLANT

H.E. Staddon, 1943. #B0117, 75pp, illus, staples ... \$7.95

Borderland Sciences Research Foundation

P.O. Box 220, Bayside, CA 95524

Please include \$2 each for S&H

Cutting-Edge Mind-Machine Technology!

Get Assured Success Faster and Easier than ever before with the New Welz Chi

Generator™ (Orgone

Generator™, EPG) at the turn of a dial! Third Millennium

Technology for... Self-Help — to improve intuition, creativ-

ity, mental powers, energy, relaxation, balance, and inner

peace. Neuro-Cosmic Programming™ — For FREE catalogue

write HSC, PO Box 666 033, Marietta, GA 30066 — (770)

425 0391 // (770) 409 0400

It's fun, it's easy, and you certainly can be laid back and relax while waiting for success

Internet Home Page and FREE Course in

Autogenic Training at: <http://www.hscti.com/>



CROSSE'S ACARI

From *Oddities - A Book of Unexplained Facts*

by Lieut.-Commander Rupert T. Gould, R.N. (Ret.), 1928

UNTIL 1836 the English public had never heard of Andrew Crosse. A small circle of friends knew that he lived at a rather dilapidated country-seat in the Quantock Hills, where he spent his time, and what money an encumbered estate allowed him, in electrical experiments. His rustic neighbours spoke of him as "the thunder and lightning man," and shunned his house like the plague, especially after nightfall, it being the subject of a legend that devils, surrounded by lightning, were then to be seen dancing upon wires encircling its grounds.

By the end of 1837 he was being reviled from one end of England to the other. He was an atheist, a blasphemer, "a reviler of our holy religion," "a disturber of the peace of families," a modern Prometheus, a would-be Frankenstein, a man who had presumptuously attempted to rival the God that made him—and many other of those flowers of speech which generally spread themselves about like leaves in Vallombrosa during the progress of religious or quasi-religious controversies.

Who was this dreadful person, and what had he done?

He was a simple, honest, and God-fearing man, belonging to a class very common in the last century but increasingly rare in this. In other words, he was a scientific amateur, having the time and money for prolonged experimental work, but gravely handicapped by a lack of scientific training and by an almost complete ignorance of the work of other men in the same field.

His offence—which, incidentally, he had not committed—was of an unusual kind. He was accused of having attempted to create living creatures, by an electrical process, from dead matter. Indeed, it was further laid to his account that he had succeeded in doing so—that he had evolved, in poisonous solutions fatal to all normal animal life, numbers of insects of the species *Acarus* (mites), which insects lived, moved, and bred.

Actually, he had done this. But he had not done it designedly, and whether what he had done was, in effect, an artificial production of life, remained and remains an open question, which he did not attempt to answer.

Here are his own words on the subject:¹

"As to the appearance of the acari under long continued electrical action, I have never in thought, word, or deed, given any one a right to suppose that I considered them as a creation, or even as a formation, from inorganic matter. To create is to form a something out of nothing. To annihilate, is to reduce that something

to a nothing. Both of these, of course, can only be the attributes of the Almighty.

"In fact, I assure you most sacredly that I have never dreamed of any theory sufficient to account for their appearance. I confess that I was not a little surprised, and am so still, and quite as much as I was when the acari first made their appearance. Again, I have never claimed any merit as attaching to these experiments. It was a matter of chance. I was looking for silicious formations, and acari appeared instead..."

The obloquy so freely showered upon Crosse left him unmoved: knowing it to be undeserved, he could afford to despise it.² It affected neither his life nor his temper. But it had one definitely evil effect—the natural result of all such persecutions. It prevented Crosse from publishing, or even communicating, his further work on the same subject. Extensive though that work was, very little record of it, or of the original experiments, has survived—and in consequence it is not easy to put together a clear account of what Crosse did and what he observed.

However, two short papers written by Crosse in 1837 are extant: one in the *Transactions of the London Electrical Society* (for 1838) and the other in the *Annals of Electricity* (Oct. 1836—Oct. 1837). In addition, his wife's *Memorials of Andrew Crosse* (1857) reproduced the substance of

the former paper, together with a letter written by Crosse to Harriet Martineau for publication in her *History of the Thirty Years' Peace* (1849). The account in the *Memorials* is largely in Crosse's own words, while that in Miss Martineau's history is based on first-hand information communicated to her by Crosse, and contains several important details which the other lacks.

The following account is compiled from these sources.

In the year 1837 Crosse was making certain experiments upon the artificial formation of crystals by means of weak and long-continued electric currents. The acari first appeared in the course of an attempt to make crystals of silica by allowing a suitable fluid medium to seep through a piece of porous stone (oxide of iron, from Vesuvius) kept electrified by means of a battery. The fluid used was a mixture of hydrochloric acid and a solution of silicate of potash.

"On the fourteenth day from the commencement of this experiment I observed through a lens a few small whitish excrescences or nipples, projecting from about the middle of the electrified stone. On the eighteenth day these projections enlarged, and struck out seven or eight filaments, each of them longer than the hemisphere

"On the twenty-eighth day these little creatures moved their legs. I must now say that I was not a little astonished. After a few days they detached themselves from the stone, and moved about at pleasure."

on which they grew.

"On the twenty-sixth day these appearances assumed the form of a *perfect insect*, standing erect on a few bristles which formed its tail. Till this period I had no notion that these appearances were other than an incipient mineral formation. On the twenty-eighth day these little creatures moved their legs. I must now say that I was not a little astonished. After a few days they detached themselves from the stone, and moved about at pleasure.

"In the course of a few weeks about a hundred of them made their appearance on the stone. I examined them with a microscope, and observed that the smaller ones appeared to have only six legs, the larger ones eight. These insects are pronounced to be of the genus *acarus*, but there appears to be a difference of opinion as to whether they are a known species; some assert that they are not (See Fig. 1).

"I have never ventured an opinion on the cause of their birth, and for a very good reason—I was unable to form one. The simplest solution of the problem which occurred to me was that they arose from ova deposited by insects floating in the atmosphere and hatched by electric action. Still I could not imagine that an ovum could shoot out filaments, or that these filaments could become bristles, and moreover I could not detect, on the closest examination, the remains of a shell...

"I next imagined, as others have done, that they might originate from the water, and consequently made a close examination of numbers of vessels filled with the same fluid: in none of these could I perceive a trace of an insect, nor could I see any in any other part of the room."

In subsequent experiments Crosse discarded the porous electrified stone, and for the most part produced the acari in glass cylinders filled with concentrated solutions of such substances as copper nitrate, copper sulphate, and zinc sulphate. The acari generally made their appearance at the edge of the fluid surface, but he remarks:

"In some cases these insects appear two inches *under* the electrified fluid, but after emerging from it they were destroyed if thrown back."

In one case the acari appeared on the lower part of a small piece of quartz, immersed to the depth of two inches in fluoric acid holding silica in solution.

"A current of electricity was passed through this fluid for a twelve-month or more; and at the end of some months three of these acari were visible on the piece of quartz, which was kept negatively electrified. I have closely examined the progress of these insects.

"Their first appearance consists in a very minute whitish hemisphere, formed upon the surface of the electrified body, sometimes at the positive end, and sometimes at the negative, and occasionally between the two, or in the middle of the electrified current; and

sometimes upon all. In a few days this speck enlarges and elongates vertically, and shoots out filaments of a whitish wavy appearance, and easily seen through a lens of very low power.

"Then commences the first appearance of animal life. If a fine point be made to approach these filaments, they immediately shrink up and collapse like zoophytes upon moss, but expand again some time after the removal of the point. Some days afterwards these filaments become legs and bristles, and a perfect acarus is the result, which finally detaches itself from its birthplace, and if under a fluid, climbs up the electrified wire and escapes from the vessel...

"If one of them be afterwards thrown into the fluid in which he was produced, he is immediately drowned. . . . I have never before heard of acari having been produced under a fluid, or of their ova throwing out filaments; nor have I ever observed any ova previous to or during electrization, except that the speck which throws out

filaments be an ovum; but when a number of these insects, in a perfect state, congregate, ova are produced."

The acari thus produced lived, generally, until the first frost, which was invariably fatal to them.

In a later experiment, Crosse succeeded in producing an acarus in a closed and airtight glass retort filled with an electrified solution, one wire being led in through the wall of the retort and the other through a cup of mercury at its beak. The solution was a silicate one, prepared as for the first experiment, and was put in hot. On connecting up the battery:

"An electric action commenced; oxygen and hydrogen gases were liberated; the volume of atmospheric air was soon expelled. Every care had been taken to avoid atmospheric contact and admittance of extraneous matter, and the retort itself had previously been washed with hot alcohol. This apparatus was placed in a dark cellar.

"I discovered no sign of incipient animal formation until on the 140th day, when I plainly distinguished one acarus actively crawling about *within* the bulb of the retort.

"I found that I had made a great error in this experiment; and I believe it was in consequence of this error that I not only lost sight of the single insect, but never saw any others in this apparatus. I had omitted to insert within the bulb of the retort a *resting-place* for these acari (they are always destroyed if they fall back into the fluid from which they have emerged). It is strange that, in a solution *eminently caustic* and under an atmosphere of *oxyhydrogen gas*, one single acarus should have made its appearance."

Crosse also succeeded in producing acari in "an atmosphere strongly impregnated with chlorine"; but while these assumed the form of perfect insects, and remained undecomposed until the

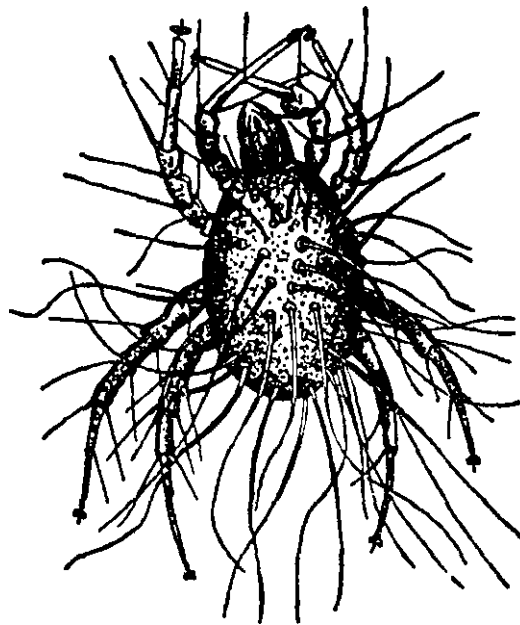

FIG. 1.—The *Acarus electricus*. From a drawing in H. M. Noad's *Lectures on Electricity* (London, 1849). NOTE.—The exact scale of the drawing, here reproduced in facsimile, is not stated. It probably represents a magnification of 100-150.

apparatus was taken apart over two years later, they never moved or showed any signs of life.

His experiments were repeated and extended by another enthusiastic amateur, Weeks of Sandwich, who took a number of precautions to ensure, as far as possible, that no animal life was already present at the start of the experiments. For example, he baked his apparatus in an oven, used distilled water, filled his receivers (inverted over mercury troughs) with manufactured oxygen instead of air, and super-heated his silicate solutions. After about a year and a half of electrification, acari invariably made their appearance. Control experiments, made in exactly the same manner and with the same apparatus, but omitting the electric current, gave uniformly negative results—no acari appeared. He also made quantitative experiments, and found that the number of acari electrically produced varied, roughly, with the percentage of carbon in his solutions.

Weeks's experiments, although most intelligently conducted, seem to have attracted little attention. He communicated a summary of his results to the Electrical Society, but does not appear to have published a complete account of them. In view of the precautions which he took, it is interesting to note that at the height of the Crosse furore (1837) no less an authority than Faraday stated, in a paper read at the Royal Institution, that similar appearances had presented themselves in the course of his own electrical experiments, but that he was doubtful whether they should be regarded as a case of production or revivification.

Should anyone in Tennessee or elsewhere be brave enough, in the face of Crosse's experience, to repeat his experiments, it may be useful to record here a caution noted by Crosse himself.

"... I must remark, that in the course of these and other experiments, there is considerable similitude between the first stages of the birth of acari and of certain mineral crystallizations electrically produced. In many of them, more especially in the formation of sulphate of lime, or sulphate of strontia, its commencement is denoted by a whitish speck: so it is in the birth of the acarus. This mineral speck enlarges and elongates vertically: so it does with the acarus. Then the mineral throws out whitish filaments: so does the acarus speck.

"So far it is difficult to detect the difference between the incipient mineral and the animal; but as these filaments become more definite in each, in the mineral they become rigid, shining, transparent six-sided prisms; in the animal they are soft and waving filaments, and

finally endowed with motion and life."

If the foregoing passage were all that we knew of Crosse's work, it might be permissible to suppose that he had simply been misled by appearances. It is quite possible to "grow" artificial forms, from dead matter, which simulate living bodies in a positively uncanny way. Artificial "plants," for example, can be grown (in certain solutions) which, although formed by a purely mechanical process—osmosis—have every appearance of life, and can even imitate the properties and movements of organic cells. The "osmotic growths" produced by Dr. Stephane Leduc of Nantes not only present the cellular structure of living matter, but reproduce such functions as the absorption of food, metabolism, and the excretion of waste products.

In spite of the precautions taken by Crosse and Weeks, it is, of course, impossible to disprove the assertion that their acari were hatched in the course of their experiments, having found their way into the apparatus as ova—the same cry of "faulty technique" that has been raised (in my submission with more force) against such experimenters as Bastian. Like Crosse, I offer no opinion.

Andrew Crosse died in the room in which he was born on July 6, 1855. He was seventy-one. For many years he had lived the life of a recluse in his Quantock eyrie, shut off from society, but happy in his marriage and his work. He died as he had lived, an honest man who would make no concession of any kind to popular clamour, but sought truth wherever he might find it. Such men are the true salt of the earth.

Postscript

An authority upon acari, Dr. A.C. Oudmans of

Arnhem, informed me in 1934 that, in his opinion, Crosse's were quite certainly the common *Glycophagus domesticus*, which is very tenacious of life and capable of getting into tins which appear to be hermetically sealed.

I hardly felt competent to argue the matter, at the time; but I have since come to the conclusion that this hypothesis, while very plausible, does not go quite far enough to cover all the reported facts. ■

Footnotes

1. In a letter, dated 12.8.1849, to Harriet Martineau.
2. I have only found him complaining once. In a letter to Dr. Noad (whose *Lectures on Electricity*, published in 1849, contain a short account of Crosse's work), he says: "... (I) met with so much virulence and abuse ... in consequence of the experiments, that it seemed as if it were a crime to have made them."

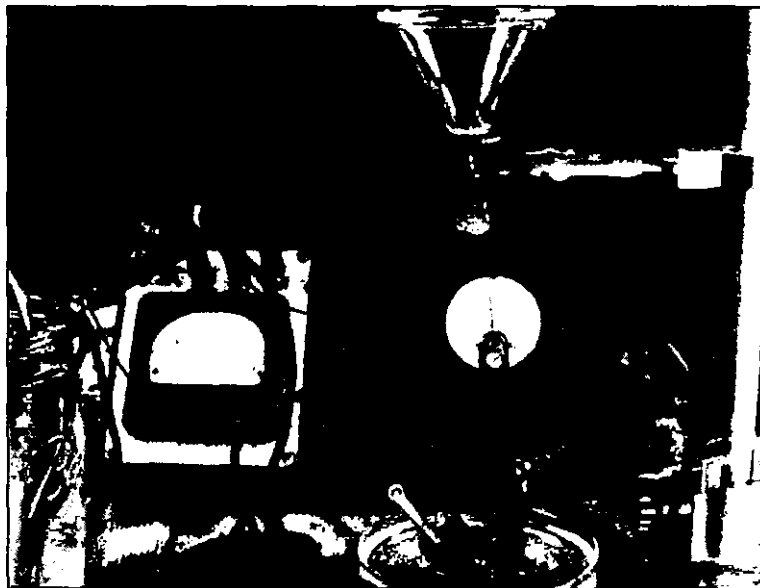

Recreation of the Crosse experiment at BSRF in August 1996. Photo taken after only two weeks exposure to current. Note open-air experimental setup. The actual production of acari will warrant further experiments in hermetically sealed containers.

Astrological Heredity: New Evidence, New Thoughts

by Judith A. Hill

ASTROLOGERS frequently observe the curious phenomenon of parent-child birth chart replication. Intergenerational planetary patterns at birth sometimes display multiple similarities so remarkable as to rule out any argument of "chance". Unfortunately, few astrologers have an understanding of how to communicate their observations to the scientific community. However, a great deal of excellent statistical work with astrological heredity has been accomplished by European researchers, most notably, French scientist Michel Gauquelin, esteemed author of *L'Heredite Planetaire* (1966) as well as several other trailblazing works on the subject of astrological heredity.¹ These works elucidate Gauquelin's findings that the births of parents, and later, their children, will occur, at odds greater than chance would allow, when the same planet was transiting one of Gauquelin's four "plus zones". (See Figure 1,2 and Notes1).

Simply stated, if you are born with Jupiter in any one Gauquelin's four "plus zones", at least one of your parents probably was, as will most likely be your children.

The Gauquelin hypothesis explaining why we "inherit" simple planetary patterns will be discussed later. My main point here is that Gauquelin devoted his heredity experiments to only one of the many astrogenetic effects — that of the spatial phenomena of a repeating planetary position in relation to the Ascendant, between the birth charts of parents and children. These replicated statistical experiments provide some of the first scientific evidence supportive of astrological inheritance.

ASTROGENETICS: A PUZZLE OF MANY PARTS

However, we do have a problem, in that Gauquelin was not himself an astrologer, and as far as I know did not engage in the practice of reading the astrological charts of clients. Because he lacked real experience in the intuitive synthesis of planetary patterns, i.e. "reading charts", Gauquelin's view of his research subject was necessarily limited. And as an astrologer, it is easy to see that he overlooked the great bulk of astrogenetic phenomena. This by no means undervalues what he did find.

Indeed, Astrology is one of few fields where much of the scientific research is carried on by those who are not fully conversant with the subject, and more often than not, hostile to it. Botanists research botany, chemists analyze chemical interactions, and so forth. Astrology often finds itself in a position similar to the brazier design industry, for years the exclusive domain of male designers. Finally, two women came along and designed the first comfortable sports bra. Ah, we diverge... but hopefully the reader has grasped the point. Equally peculiar to astrology as a field, is the fact that it is practiced by those who metaphorically speaking, are driving a car

without knowing how it works.

Gauquelin's pioneering experiments with astrological heredity (and those of his predecessors Paul Choissard², and Karl E. Krafft³, or contemporary astrologer John Dey⁴), do constitute the first significant contributions to the nascent research field of astrogenetics. Personally, I offer no criticism of either his methods or his findings. However, I will begin where Gauquelin left off, in an attempt to reveal "new" evidence of inherited planetary patterns of a complexity that defies our current understanding of cosmobiology.

To repeat, Gauquelin preoccupied himself with only one, rather common type of repeating planetary pattern between parents and children. However, the briefest observation of family planetary birth charts reveals (to the seasoned astrologer) how several types of similitudes occur between the generations. Below, is a list of the more outstanding types of repeating planetary patterns commonly found to occur between parents and children. I have developed this list from my own research, remaining aware, that this too, is incomplete. *Note: The slow moving outer planets Uranus, Neptune and Pluto will not be included here. References are made only to the "Ptolemaic" lights and planets: Sun, Moon, Mercury, Venus, Mars, Jupiter, and Saturn. I am not yet sure as to whether or not to include the North and South lunar nodes, as they do seem highly important in several studies.*

The planetary similarities can be categorized into four sections. A: Sign related similarities. B: Similarities of planetary order. C: Gauquelin's plus zones. D: Hill and Thompson's "Strong Zone", for distinct planetary physical type or study of a precise genetic trait, (discussed later).

A CLASSIFICATION OF INTERGENERATIONAL PLANETARY PATTERNS

Astrogenetic Criteria A: Sign related similarities

A1) Same sign: The same planet tenants the same sign in both planetary birth charts (see figure 3).

A2) Same degree: Any planet within one planetary birth chart is located on a degree of ecliptic longitude that is conjunct, (within 1 degree of orb), any other planet in the compared birth chart.

A3) Same degree, opposite: Any planet within one planetary birth chart is located on a degree of ecliptic longitude that is opposing, (within 1 degree of orb), any other planet in the compared birth chart.

Astrogenetic Criteria B: Planetary Order

B1) Same Spatial Placement: A single planet occupies a similar spatial area of both birth charts, in relation to the horizon axis (Asc-Desc). Variance between compared charts must not exceed 45

neously, by sign placement. *Note: A Magnitude 3 "R.P.P." is an extremely rare occurrence between any two random (non-related) planetary birth charts.*

Additional Research Suggestions

C: Gauquelin "plus zones". Figures 1, 2

D: Hill and Thompson's "Strong Zone" for planetary type, and/or visible genetic trait. Figure 4 (discussed later).

E: Astrologer John Addey's "Harmonics"²⁰ (not a topic of this article).

INTRODUCTION TO THE EXAMPLES

As we can see, Gauquelin found the proverbial tip of an iceberg in his discovery of the intergenerationally repeating spatial relation of single planets to the Ascendant at birth (Criteria B1). He hypothesized, proved, and later, replicated this one, clear astrogenetic phenomenon. Undoubtedly, this clarity facilitated an easy use of the scientific method. Also, simplicity is always best when presenting astrological research in a climate of ignorance about; and hostility towards astrology. The trouble is, that astrogenetic effects are not simple.

Gauquelin's method differs from mine, because first, he uses only one planet at a time, and secondly, he allows it to be anywhere within one of his four pre-established "plus zones". He was utterly unconcerned with the sign relationships of planets, and ignored repeating planetary patterns by order of rise, and also by spatial position outside the boundaries of his favored plus zones, as well as multiple positional repeats of planets between two charts, (as outlined above under "Astrogenetic Criteria B: Planetary Order"). And as we shall see, these criteria provide additional keys to the mystery of astrological heredity.

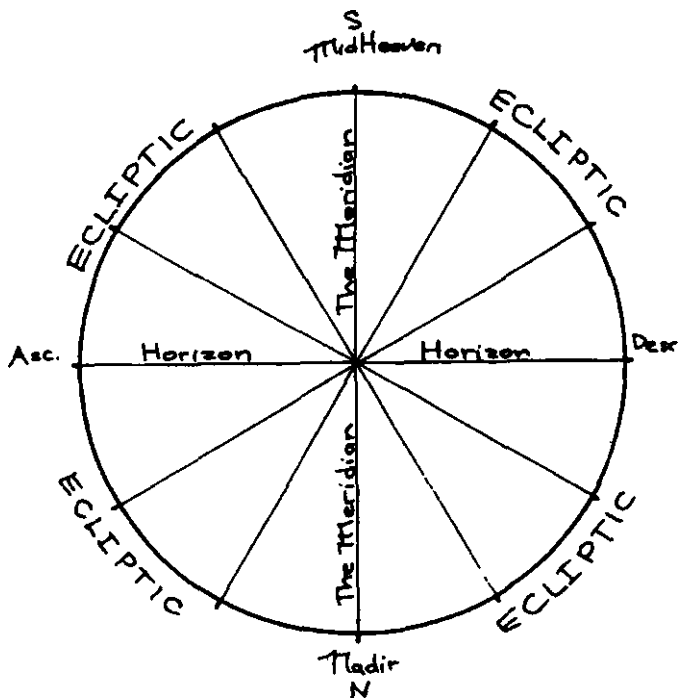

Fig. 1
Astrological Chart Constructs

degrees.

B2) Same Spatial Placement, Opposite: A planet in one chart stands opposite to other by angle to the horizon axis (Asc-Desc) in the birth chart. Variance between compared charts must not exceed 15 degrees.

B3) Same Planets, Same Phase Angle: Two planets remain in the identical phase, or aspect in both charts. Orb is debatable. For now, a suggestion that the variance of orb between compared charts should not exceed 15 degrees.

Rare Planetary Pattern Replications

B4) "Magnitude 1 Repeat Planetary Pattern": Same Order of Rise, Two or More Planets: The order of the rising of two or more planets repeats between the two compared planetary birth charts. Example: "Jupiter rises at the Ascendant before Mars, which then rises before the Moon".

B5) "Magnitude 2 Repeat Planetary Pattern": Same Order of Rise and Same Spatial Placement, for Two or More Planets: The same order rise of two or more planets, as described in "1", is also simultaneously occurring spatially, with the planets located within the same generalized relationship to the Ascendant of the birth chart. Variation of spatial placement (arc to the Ascendant) must not exceed 45 degrees between the compared charts. *Note: This type of "Mag. 2" repeating planetary pattern is rare between random (non-related) astrological charts.*

B6) "Magnitude 3 Repeat Planetary Pattern": Same Order of Rise, Same Spatial Placement, and Same Zodiac Signs for Two or More Planets: Position of planets repeat by order, and by relationship to Ascendant (not exceeding 45 degrees of spatial variance by arc to the Ascendant between the compared charts,) and simulta-

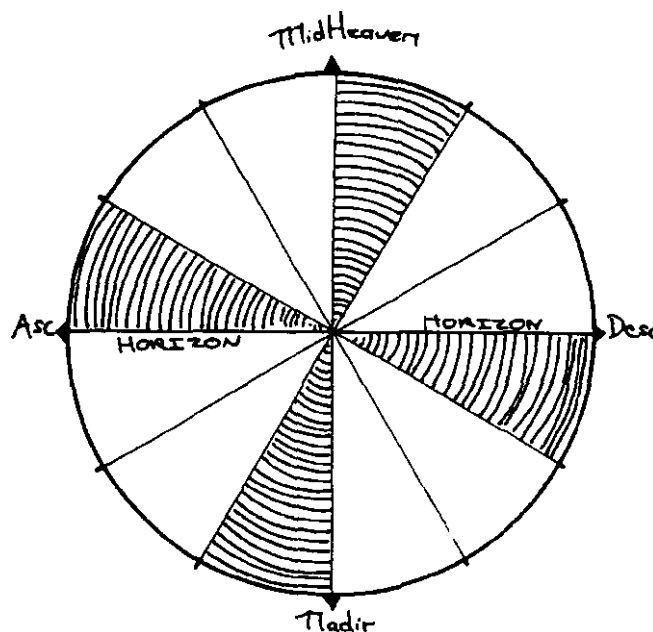

Fig. 2
The Gauquelin "Plus Zones."

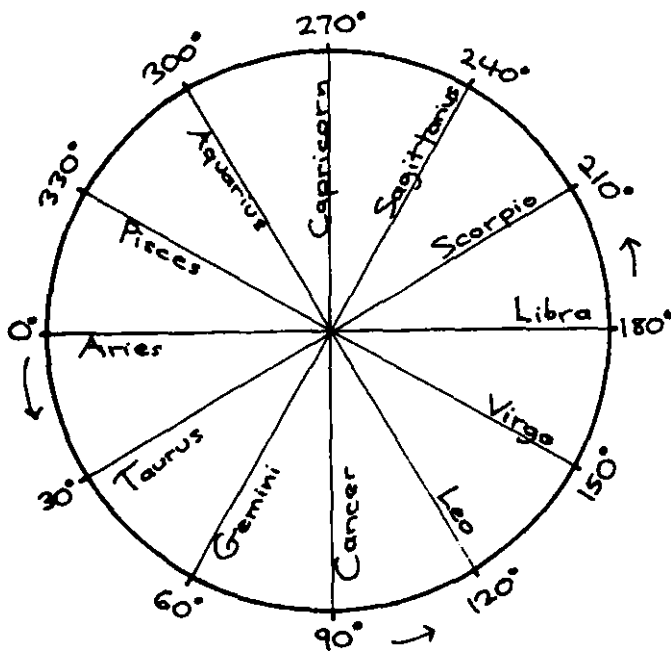

Fig. 3

Zodiac Sign Sectors by Ecliptic Longitude

Dramatic Evidence of Intergenerational Repeats of Planetary Pattern at Birth:

Figs 5A-5B, 6A-6B, 7A-7B

In the example figures, the Ptolemaic planets are drawn in their general position to the Ascendant/Descendant horizon axis of the birth charts of parent and child, as shown in Figure 1. Zodiac Signs are not included here in Figures 5 and 6, although may be commented upon. My commentary and focus will be nearly exclusively directed to type "B" astro-heredity criteria.

Generational Pair: Fig 5A-B:

Illustrated here are the rough planetary birth chart^s of a mother and her eldest son... a rather typical sample selected from my files. Here we find that six of the seven Ptolemaic planets retain an identical order. This means that both mother and son were born when Sun rose before Mercury, which rose before Mars, which rose before Venus, which rose before the Moon, which rose before Saturn. The only outlier is Jupiter, here drawn outside the borders of the chart. This constitutes an outstanding example of a "Magnitude 1 Repeat Planetary Pattern", (Criteria B4). Curiously, the Jupiter positions of mother and son, are opposite one another, placing them along the same spatial "polarity".

Now look again. Five of seven planets are also in relatively the same spatial positions to the horizon axis! This represents a fine example of a "Magnitude 2 Repeat Planetary Pattern", (B5). The Moon, the one "outlier" in this case remains in the general vicinity for both charts, scooting down under the horizon in the son's chart, and therefore outside of my allowance of 45 degrees of variance for this criterion.

Is this remarkable example of astrological heredity a coinci-

dence? Perhaps. I have performed no statistical tests to establish the rarity of such a repeating pattern, were it random. However, as a seasoned astrologer also possessed of wide statistical experience with comparative chart similarity⁴, I know that randomly compared charts do not behave this way. One could collect random charts all day, (barring family members, close friends or those born within the months of the two examples), and never find two compared non-related charts producing a five or six planet "Magnitude 2" similitude. What is more impressive, is that such occurrences are not uncommon between the charts of parents and their offspring. Let us take another example.

Generational Pair: Figure 6A-B:

Here we have the planetary patterns, from the Ascendant at birth for a father and his first born, a son. Once again, six of seven Ptolemaic planets stand in identical order of rise for both horoscopes. What is most astonishing, is the fact that five of these six planets also tenant the same vicinities, in relation to the Horizon axis, with a variation by no more than 45 degrees of arc. Again, an outstanding example of a rare "Magnitude 2" (B5) horoscopic similitude. The one outlier, Mars, yet demonstrates a powerful criterion A1 similarity, being twice located in Sagittarius, closely conjoined at 253 and 255 degrees of ecliptic longitude for both father and son.

Let us now progress to a more complex case study, inclusive of several examples of normally illusive "Magnitude 3 Repeat Planetary Patterns", (Criteria B6).

Generational Pair: Figures 7A-7B:

These two charts illustrate the planetary birth patterns of a mother and daughter. On the outside of the wheel you will find

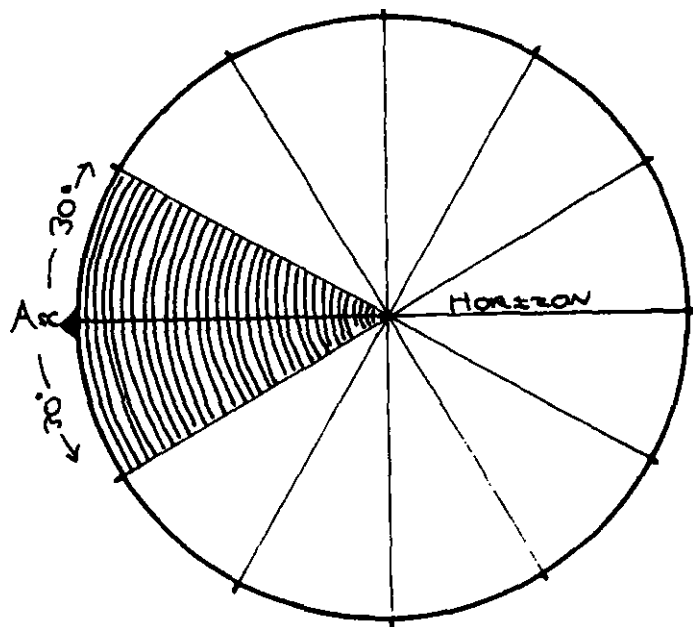

Fig. 4

The Hill and Thompson "Strong Zone" for Mars in Redhead Populations

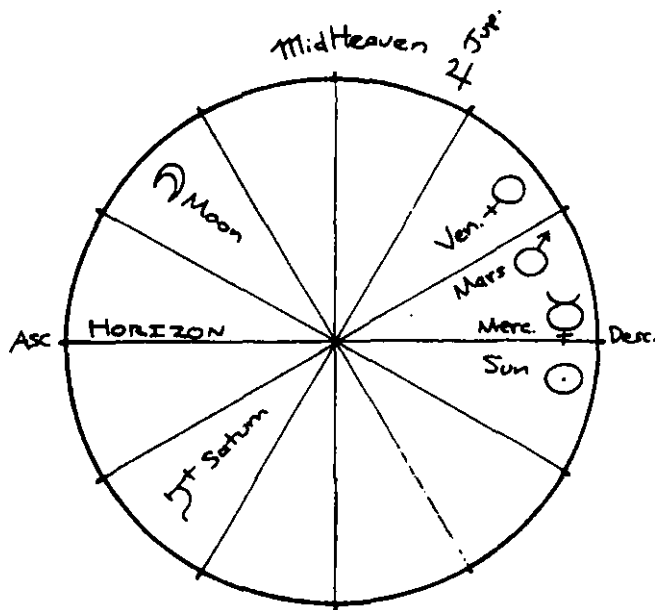

Fig. 5A
Mother

included the degrees, in ecliptic longitude of the twelve zodiac signs, necessary to the demonstration of "Mag. 3 Repeat Planetary Patterns" (B6). Ascendants are mutually in the sign of Virgo, so I have started the wheel at that point, or 150 degrees=Virgo.

First note the remarkable fact that Sun, Moon, Mars and Saturn all share the same zodiac signs, and simultaneously, the same relative locations by angle to the horizon axis (Asc-Desc). This means that the mother gave birth to daughter in the month of her own birth, on the precise moon phase of her own birth, at the nearly identical time of day as was her own birth, and in a year when Saturn, Mars and the lunar nodes returned to the signs they tenanted at her own birth. To top this off, we discover that the lunar nodes are in exactly the same degrees of ecliptic longitude!

Not including the lunar nodes, we count an astonishing eight separate replications by phase angle, (criterion B3) between these two charts. These are: Sun-Moon, Sun-Saturn, Saturn-Moon, Saturn-Mars, Moon-Mars, Moon-Mercury, Mars-Mercury, and Mercury-Saturn. And, again, these are repeating phase angles are simultaneously occurring within identical zodiac signs. This last factor alone occurs at a chance of (roughly) one-in-twelve for each planet singly. Roughly, because critics will point out how some planets spend more time in some signs, and certain sectors of diurnal motion, than do others¹⁹, but this fact hardly impacts the unusualness of what we here behold.

Random, Non related Birth Charts

Randomly selected, unrelated birth charts do produce similarities of planetary pattern by sheer chance and coincidence. However, they do not display the astonishing number of similitudes found in some (not all) parent-offspring pairs. In order to loosely prove my point, I have pulled the first four random, non related

charts out of my alphabetized file. The possessors of these birth charts do not know each other, and are not genetically related. We will compare these two randomly formed pairs for repeat planetary patterns using my same astrogenetic research criteria as outlined for comparing the birth charts of parents and children. See Figures 8A-8B and 9A-B.

Random Figures 8A-8B:

This random, unrelated pair of birth charts displays one fine example of a fairly rare "Magnitude 2" R.P. P., because Mars and Saturn do rise in the same order, and are simultaneously in the same relation to the horizon axis, with a variation by orb not exceeding 45 degrees. Certainly, this repeating planetary pattern is also typical of parent-child birth charts. However, compare this example, cited from a random chart duo, to the excess of five such observances for each of the previous three examples of "typical" heredity pairs. Also, there are no further similarities for the random pair, according to my established criteria.

Random Figures 9A and 9B:

There are no examples of Magnitude 1, 2 or 3 Repeat Planetary Patterns for this pair of random, unrelated birth charts. There is one occurrence of a single planet (Mars) occupying a similar region of the chart in relation to the horizon line (criterion B1).

PROBLEMS INHERENT TO ASTROGENETIC RESEARCH

Barring the skeptical possibility that I have invented these example heredity pairs, you have just witnessed for yourselves a direct visual "proof" of astrological heredity at work. However, there are several difficult problems from the scientific standpoint. First, the similarities between any two charts are theirs alone, and do not repeat reliably for the newly observed generational pairs. The

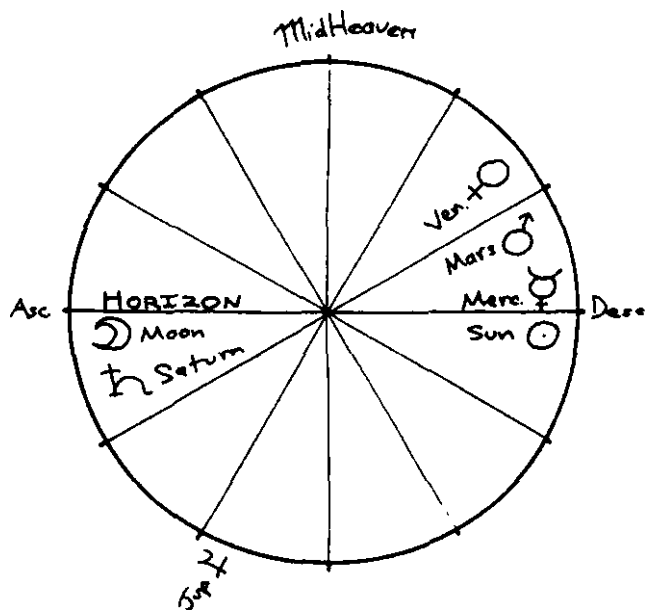

Fig. 5B
Son (Eldest)

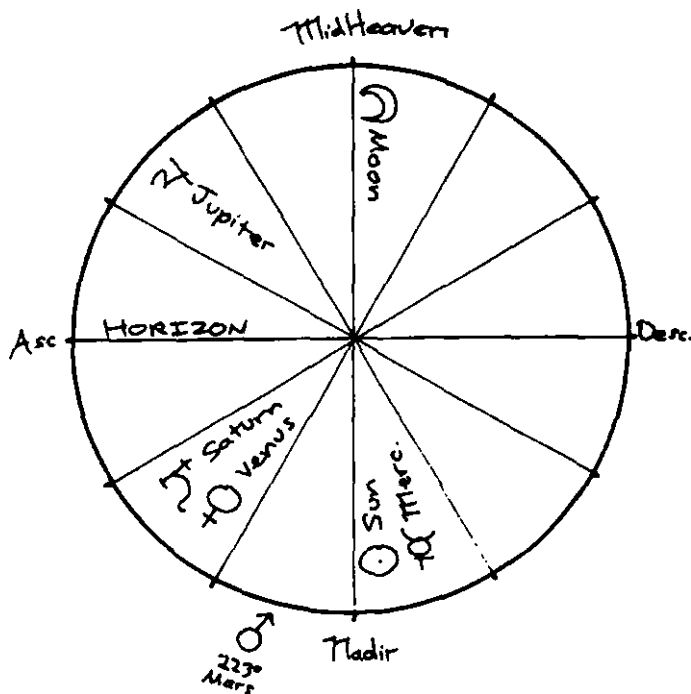

Fig. 6A
Father

scientific method demands precise replication of single observations. This demand has been very difficult on astrologers, because the solar system does not reproduce absolutely identical planetary patterns. Your planetary birth pattern is a one time thing.

Astrologers, trained to find similarities between unidentical, planetary patterns, are accused of being "unscientific". The scientific method, and its demand for exact replication of identical patterns, is perhaps equally guilty of being "unastrological". This is why I have developed the astrogenetic research criteria, especially criteria A and B. These criteria are loose enough to include several possible planetary combinations of the Ptolemaic planets, and can therefore be analyzed according to the demands of the scientific method. The total tallies for my criteria A and B, for generational pairs, can be compared to the same counts of control groups. Future researchers can include any and all planetary similarities occurring between generational pairs, count them, and compare these counts with non-related pairs of control charts.

Another problem of astro-heredity is its undependability. Your chart may replicate your father's birth pattern in many ways, while showing little in common with your mother's. Or, you may resemble your mother, and yet show no strong astrological inheritance from her family line. However, it is equally likely that your planetary birth chart will indeed resemble the birth chart of a near relative, and this resemblance will be to a degree not seen between random pairs. The reasons for such undependability are difficult to fathom because we do not understand the mechanism behind "inherited" astrological pattern. And to ponder the mysterious mechanism behind astro-heredity, we must first pose the questions inquiry demands.

- Question 1: Do planetary patterns at birth reflect the genetic code?
- Question 2: Does planetary heredity operate within its own sphere, unrelated to genetics?
- Question 3: Can planetary patterns, and other cosmobiological influences operative at one's first breath, influence in any way the genetic code already present within the DNA at the time of birth?

It is accurate to state that none of these three pivotal questions can be adequately answered at our present state of near ignorance regarding cosmobiological mechanisms and their role in genetics. The following discussion is designed as a stimulus for debate and the broadening of thought upon the how and why of astrological inheritance.

Question 1 (Restated): Do planetary patterns at birth reflect the genetic code?

Gauquelin held that astrology does not cause genetic phenomena, but instead, reflects something about the genetic inheritance. He hypothesized that humans, as do oysters, possess some kind of internal time clock sensitive to planetary motion¹. Not all people were attuned to the diurnal motions of the same planets, as this varied between families. Some individuals were attuned to Mars, while others inherited a sensitivity to Jupiter, Saturn or the Moon. According to Gauquelin, almost nobody was attuned to Mercury or Venus, although I am quite sure that astrologers would beg to differ. You are more likely than chance would allow to share an inherited attunement to the same planets as do your parents. Your birth will therefore be triggered when your "family planet" transits certain Gauquelin established power zones in the sky, in relation to the prevailing ascendant. These areas are the Gauquelin "plus zones" (Figure 2).

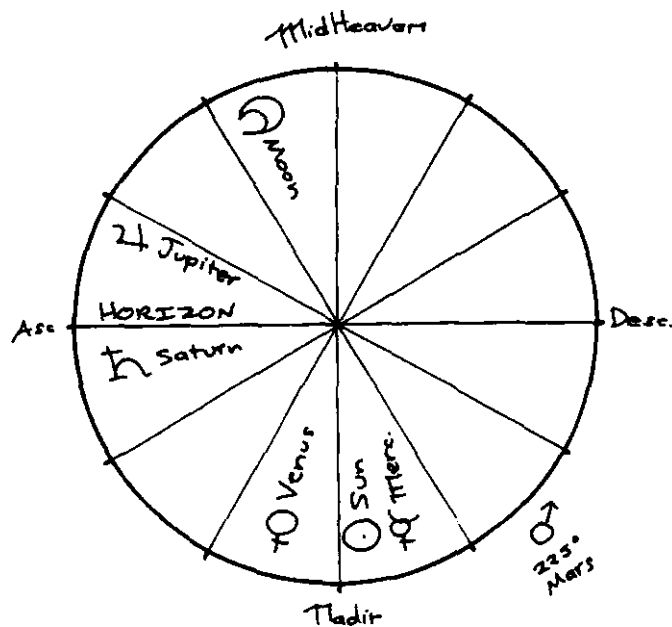

Fig. 6B
Son (Eldest)

Gauquelin believed that planetary heredity is nothing more than a reflection of your inherited sensitivity to the motion of a certain planet. You inherit this sensitivity from one or both parents, and you display your planetary proclivity by being born when "your" family planet transits the appropriate area of the sky where it seems to trigger parturition.

Gauquelin's theory, as one of the only published "scientific" theories to date, should not be too readily dismissed. However, could his mechanistic explanation be incomplete? Obviously, his theory does not account for the complexity of multiple pattern astrological heredity as shown by my few examples here. Neither does his hypothesis address or give answer to my questions 2 and 3. Additionally, the actual mechanism of internal time clocks remains unclear, although scientific research now exists proving that certain species, (oysters, flatworms, etc.^{1A}) do indeed possess them.

Typically of modern scientists, Gauquelin did not believe we were "influenced" in character, appearance or life timing, by the planetary light and radiation patterns impregnating, as it were, our first breath. The modern scientific paradigm to which he adhered, flies in the face of over 2000 years of empirical and anecdotal astrological evidence. However, he was an open minded man, as demonstrated by his statement, "I think it would be absolutely surprising if only the Gauquelin stuff would stand. There's a lot more to be found — I hope!... If some new fact is there, it's very important that we welcome this fact. Even the discussion of a possible fact is raising the ability to discover."⁹

WHY SCIENCE REJECTS ASTROLOGY (THE REAL REASONS)

We will diverge off our main question for but a moment in order to better understand why "science", on policy, remains hostile to astrology. And although this rejection reaches almost religious proportions, few of science's anti-astrological proponents have ever genuinely studied astrology! (If you don't believe me, just ask the

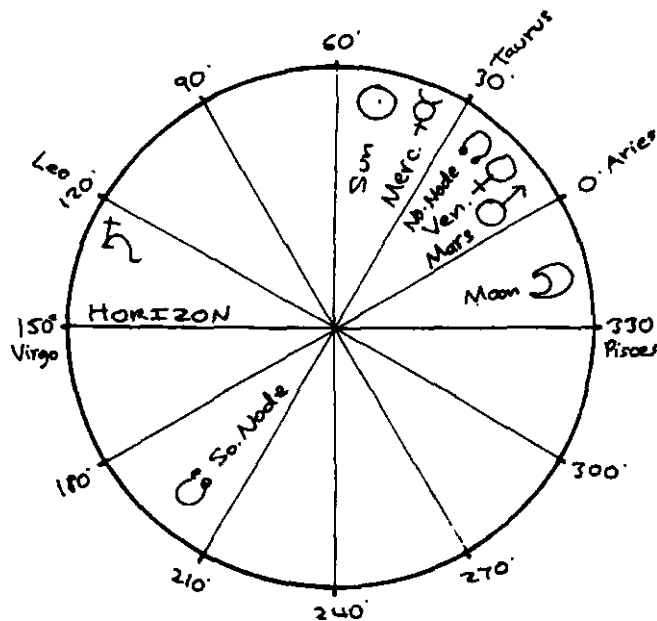

Fig. 7B
Daughter

next virulent skeptic you meet exactly how many years they have studied astrology, and can they construct, and then, interpret your chart for you). Fortunately, there exist scientists and physicists who are interested in astrological ideas, or who are themselves consummate astrologers. The late, great Arthur Young²¹ comes to mind.

Of course, there are many reasons, dating back to the early Renaissance, as to why "science" is antagonistic to "astrology". However, perhaps the two most outstanding reasons go overlooked. This is very simple: *Science recognizes quantities of time, but not qualities of time.* Astrologers recognize both. "Quantity" here refers to minutes, seconds, months, light years, etc. "Quality" refers to feeling, mood, and character. The manifestation of quality is partly witnessed on the human level as personality and individuality. Again, science fails to recognize quality as an inherent attribute of moments of time. Astrologers recognize the moods of time. *Astrology is the science of the classification and description of the qualities of time, by means of the categorization of the quality and quantity of cosmic radiations.*

This brings us to our second reason for the scientific disclaiming of astrology. Scientists classify radiation by wavelength, and identify its physical properties. *There is little scientific concern with emotional and spiritual effects of wavelength.* Astrologers classify distinct types of cosmic radiation first, by relative strength, and secondly, by its qualitative effects on human beings and world events. Some of these effects involve character description. Science does not acknowledge a qualitative expression of vibratory wavelengths for solar, lunar or planetary radiation, or light, as influencing the character of human beings, or the mood of a moment.

Contemplating this essential, and huge distinction between scientific and astrological paradigms, it is easy to see why "science" rejects astrology. It doesn't understand it!

When a scientist hears someone say something like "I am a writer

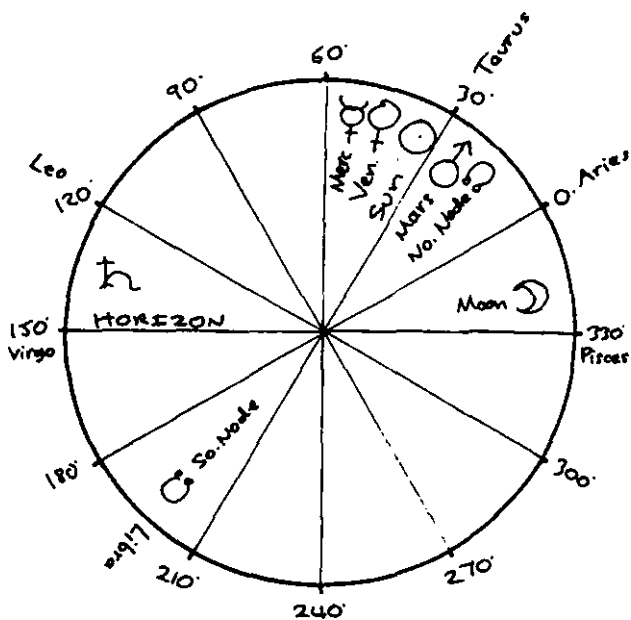

Fig. 7A
Mother

because my Mercury is on the Mid Heaven, in Gemini", he dismisses him as a nut. But what is "the nut" actually saying? The chances are they don't even know themselves, but this does not mean they are inaccurate. What our astrological buff is really saying is that he was born precisely when the unique radiation of Mercury was quantitatively strong, because it was located near the Zenith, a place from where cosmic radiation is most readily received by earth. Secondly, the Mercurial radiation was moving through a 30 degree sector of the ecliptic plane, classified by astrologers as "Gemini". This Gemini sector possess a unique flavor, or quality of vibratory energy, which has been further observed by astrologers to enhance the radiations of Mercury, due to a strong harmonic similarity between the two. Furthermore, Mercurial light and radiations (recognizably of an unknown order) are of the quality that expresses itself among human beings so imprinted at birth (see Question 3) as a physical and personality type that enjoys writing.

And why not should vibration have emotional quality, and impart that quality to us? Every form possesses a unique vibrational frequency. Color, sound, form, are largely the result of different vibrational frequencies.

Before progressing to our second question, it is important to briefly discuss the first known attempt of a large scale scientific/statistical study of a single astrogenetic phenomenon.

The Redhead Projects

In order to study astrogenetic phenomenon, I founded Redheads Research in 1986, in the hopes of obtaining a large number of birth charts from one recognizable genetic population. With the assistance of research partner Jacalyn Thompson, we initially succeeded in collecting a first group comprised of the birth data of 500 natural redheads. Following hints from astrological tradition that planets found "near" the Ascendant at birth should describe physical

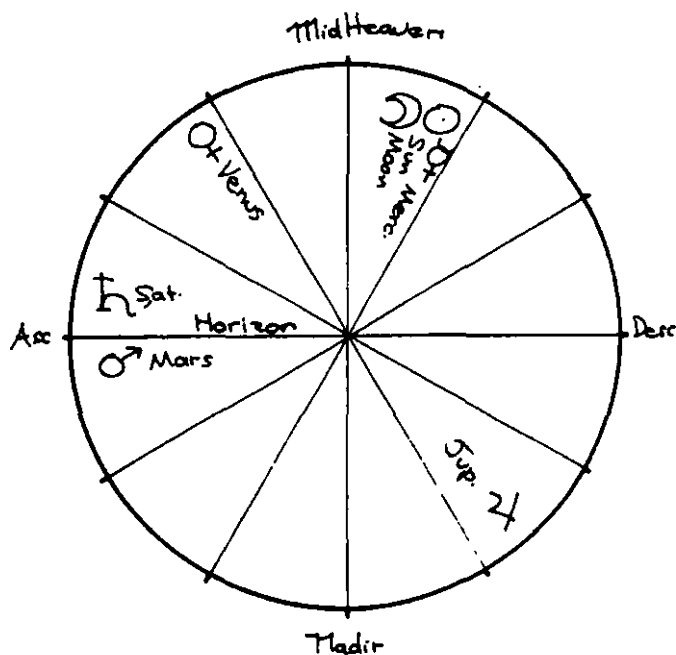

Fig. 8A
Random, Nonrelated Chart Comparison

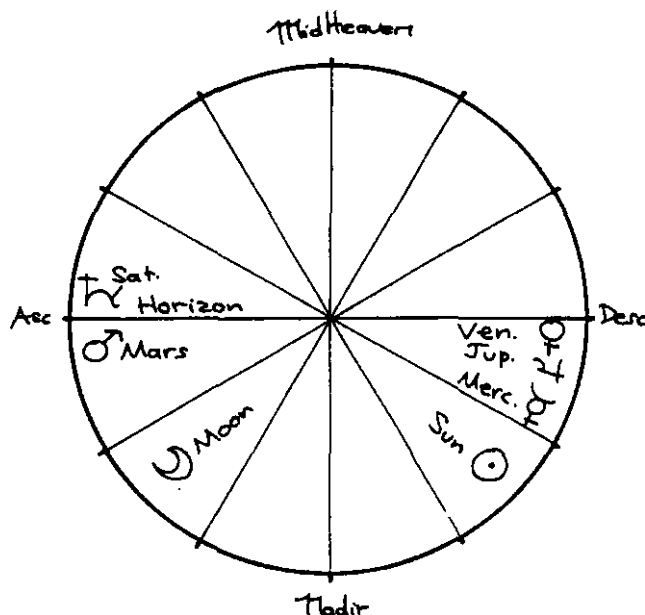

Fig. 8B
Random, Nonrelated Chart Comparison

appearance (Notes 2A-H), we hypothesized that the planet Mars should significantly tenant our hypothesized "Strong Zone" (Figure 1C). Our first results were overwhelmingly in favor of the astrological hypothesis when between 28-33% of redheads collected apparently preferred to be born when their patron planet, Mars was within 30 degrees of the Ascendant, our suggested "Strong Zone" for Mars in the birth charts of redheads.^{6A-D}

Consequential replication studies proved quite interesting. Surprisingly, earlier British redhead data, collected twenty years prior to our work^{6B} came to light, and produced similar distribution curve for Mars. The American-Canadian replication study (1993-5) produced mildly significant results for Mars distribution at birth within Hill and Thompson's "Strong Zone". Additionally, an extremely similar "signature" wave of Mars through the 12 astrological house sectors was once again reproduced by the redheads, and did not replicate in the control (non-redhead) populations. The current British redhead replication, conducted by Beverly Steffert Ph.D., and Mike O'Neill B.Sc., did not produce significant results. However, on closer examination, the Mars distributions for this group was seen to slightly outperform all control groups within Hill and Thompson's Strong Zone, while also producing a strongly angular 12 house distribution curve quite anomalous to the "flat" looking control curves and yet similar to previous redhead groups. (Figs.10,11,12).

The full details on the redhead research findings are available elsewhere.^{6A-H} As far as we know, these studies comprise a historic first international scale statistical research effort into an astrogenetic phenomena.

How is it that redheads prefer, as a group, to be born when Mars tenants certain sectors of the diurnal wheel, while avoiding others? Individual redheads are not related by family, and yet they clearly produce a signature curve wave for Mars distribution at birth

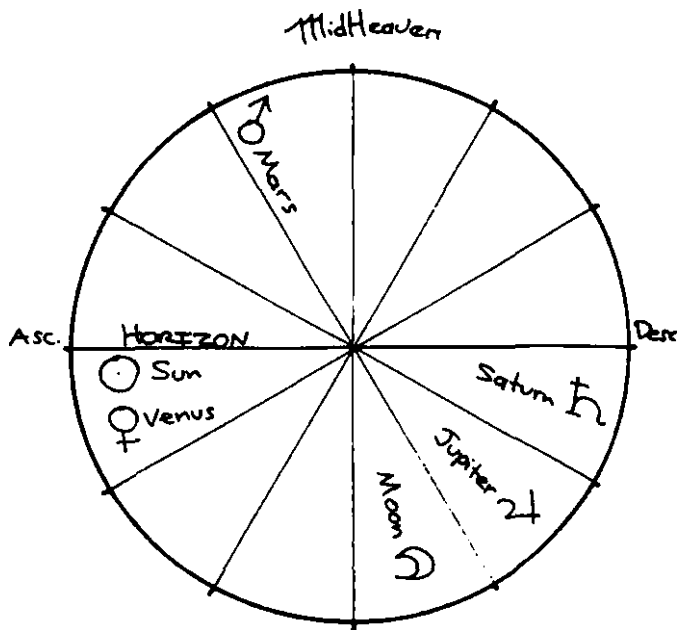

Fig. 9A
Random Nonrelated Chart Comparison

through the 12 astrological houses. Is the redhead gene therefore reflected, en masse in this signature curve wave? Or is it that redheads, as a group, possess an internal time clock sensitive to the motions of Mars in certain sectors? Or is it something else, unforeseen by Gauquelin?

Perhaps a missing key to the physical side of astroheredity lies with the remarkable work of chemist Frau Lily⁷. Because of limited space, I will describe her research briefly. Frau Kolisko, and several replicators, were able to establish the fact that metals, when placed in solution, and applied to dipped filter paper, can be readily observed to respond to astrological phenomena. And each metal responds only to its "own" corresponding metal assigned by early astrological tradition. (Sun=gold, Moon=Silver, Mercury=Mercury, Venus=Copper, Mars=Iron, Jupiter=tin, Saturn=lead). For instance, Mars "rules", i.e. bears a vibrational affinity, with the metal iron. Ferrous sulfate (iron) will be seen to react unusually immediately following the moon's conjunction with Mars.

"Aha!", says the astrogenetic researcher. Are not our bodies partially composed of various radiation conducting metals? Certainly too, these metals vary in their abundance between individuals. For instance, men have 20% more iron in their bodies than women, and likewise women have 20% more copper than men. And is not red hair red because of the presence of trichosideran, a chemical compound made partly of iron and found only in red hair? Perhaps we have stumbled on to one of Gauquelin's "internal" time clocks...metals! And are Gauquelin's planetary genetic types, as well as the planetary types of astrological tradition¹⁹ really "metal" types?

Question 2: Does planetary inheritance operate within its own sphere, unrelated to genetics?

This question is interesting indeed, when viewing a quote from Rudolf Steiner: "Choice of incarnation is usually made at concep-

tion, when the channel for expression is opened by the parents. A pattern is made by mingling the soul patterns' of the parents... a soul whose karma approximates these conditions will be attracted by the opportunity presented. Since the pattern will not be exactly his own, he must consider taking on some of the karma of his parents... (other) soul it wishes to be with... The body is formed in the womb according to the pattern made by the mingling of the life forces of the parents, each with its respective pattern... on rebirth the individual has to bring with him forces ("planetary" and karmic) which, once he has connected himself with the stream of heredity, enable him to fashion plastically his corporeal form... What is provided by our ancestors in the physical heredity stream only corresponds to the individuality inasmuch as we are attracted by the mixture in the heredity stream.. (formed by) the nature of our forefathers."⁸

This statement provokes an entirely new line of thought regarding the mechanism for observed astrological inheritance. Let us view the planetary birth patterns not as reflecting genetics, but instead, as a complexity of cosmic tides and energies under which a particular soul may be attracted to incarnate for a wide variety of purposes. He/she may share unique soul lessons, or similar karma with his parent, who was likewise attracted to be born, years earlier, under comparable planetary conditions. The birth charts of parent and child are unusually alike, not because of genetics, but because the two souls were attracted to their physical births under strongly equivalent astrological "weather" conditions.

This would explain the problem of why we may share strong planetary similarities with one parent, and not with the other! The mechanism of attraction could involve Gauquelin's genetically inherited internal time clocks. However, it may not be this all the time, nor in every case. Rather, the soul, and not the body, may have it's own type of "time clock", or more likely a computer that involuntarily prods us to rebirth under the most appropriate astrological influences. What we observe as planetary heredity, may in

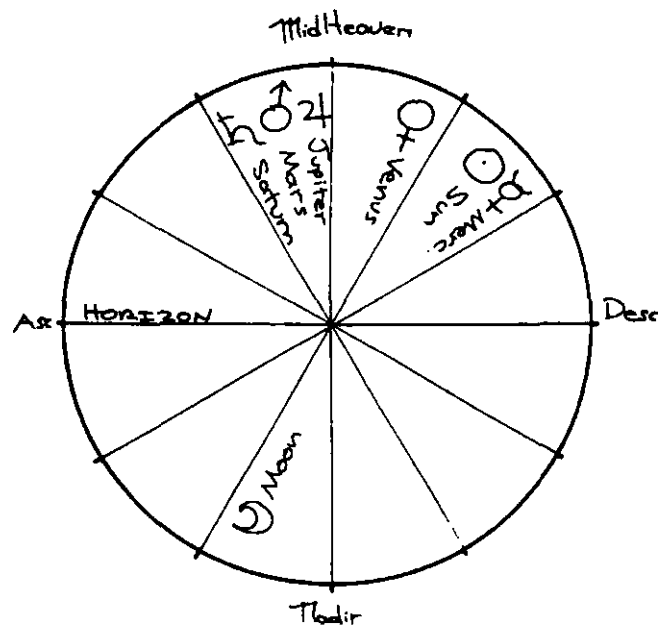

Fig. 9B
Random Nonrelated Chart Comparison

fact not be an entirely physical phenomenon, nor are limited to the chemical-molecular plane. Planetary patterns may also represent karmic patterns, and various types of other conditions attractive to the souls that share them. If this is true, then close friends may share strongly similar horoscopes as would adoptive offspring with certain family members.

Question 3: Can planetary patterns, and other cosmic energies operative at one's first breath, influence our genetic code already present within the DNA at the time of conception?

Despite the known fact that DNA can be damaged through poisonous radiation, there prevails the assumption that once your DNA pattern is established at conception, then you are now an unalterable physical entity. In light of this idea, it is interesting to read how Luther Burbank literally talked the thorns off of a cactus.¹⁷ Margaret Hone⁹ demonstrated how sound waves cause sand and dust particle to form shapes on the vibrated membranes of her "Eidophone". Her simple experiment suggests how readily matter responds to externally applied vibration. And who yet knows what unknown radionic, magnetic, or astral vibratory wave lengths interact with earth's biological life forms? Except for their potential damage of DNA by noxious substance, we know nothing about the alteration of genetic patterns by means of applied cosmic radiation.

Does the planetary birth pattern merely reflect our genetic inheritance, as Gauquelin suggests, or do cosmic influences actually influence our character, and appearance in some yet unknown way? Skeptics mock astrologers with their favorite axiom about a how a passing bus exerts more gravitational pull upon you than does the distant moon... and therefore astrology is silly. However we live in a veritable sea of cosmic radiations, of which science is only beginning to comprehend.

New ideas about the magnetic field of earth and its mechanism of interaction with the magnetic fields of each planetary set forth in South African scientist Percy Seymour's important book *Astrology, the Evidence of Science*.¹⁰ Seymour describes how the magnetic fields of the solar system interact with, and are magnified by their contact with the plasma of earth's outer magnetosphere. He says, "Trapped in this extended magnetic field are a number of charged particles⁵ that form what is known as plasma. The magnetic field forms a series of bays, estuaries and canals that can amplify the tidal forces of the planets on the plasma. This situation is further improved by the fact that the magnetic field itself can be pictured as a series of elastic bands, stretching into space, that have their own natural frequencies, and some of these are in tune with the tidal pull of some of the planets."

He goes on to describe, in detail, exactly how earth's magnetosphere can vibrationally resonate with, and amplify the magnetic forces of planetary origin, continuing on to correlate his ideas with the Gauquelin's astrological heredity hypothesis. A must read.

Physicist Buryl Payne suggests¹¹ that the Sun, "changes its radiation in some fashion that is associated with the planets, perhaps it sends a different radiation to each planet. When earth moves into alignment with a planet, then, Earth is bathed in an extra amount of the radiation associated with that planet. These changes may be dramatic or subtle."

Payne also observes how tiny radio waves are produced in the protons at the center of the hydrogen atoms constituting the water

molecules of the body. He says, "This is the same effect which MRI or Magnetic Resonance Imaging makes use of."¹¹

There are more hydrogen atoms within our bodies than any other type. Payne outlines three additional hypotheses regarding the mechanism for earth's interaction with the radiations of the solar system, although in respect of my space limitations, I must stop here.

Earlier, scientist Georges Lakhovsky described each bodily cell as a miniature oscillating unit, or tiny radio! His *The Secret of Life*¹² describes the ways and means whereby our miniature cell radios receive, store and transmit frequencies of terrestrial and cosmic origins. Motivated by his interest in curing disease, Lakhovsky pursued a considerable amount of experiment along these lines, which was later replicated by several others in his footsteps.

There is not the space here to elaborate further on the pioneering geocosmic experiments and ideas of Lakhovsky, Seymour, Payne, and scores of other men and women, or upon the astrological traditions that bear upon these points. One wonders how long the scientific hierarchy will continue to ignore this weight of evidence and ideas supportive of cosmobiology. However, before we put it all together, let us first briefly consider an important idea from traditional astrology.

THE TRADITION OF THE "PLANETARY LIGHT"

At this juncture, it would be interesting to note that Vedic astrologers possess an ancient, sophisticated system of enhancing, and deflecting (as desired) the varying and dissimilar types of planetary "light", through means of a precise gemology. This system is known as "Upaye", which literally means "antidote".^{13,15} Planetary radiation, and "light", are serious matters to Vedic astrologers, and it is taken for granted that they can influence our character, lives and health. To avoid a predicted illness, Guru Paramahansa Yogananda¹⁶ wore a unique bangle, composed of an exact mixture of metals, said to act in the manner of a lightning rod to negative planetary radiation.

Physicist Payne suggests that "Possible changes in the light form the Sun produces effects on the DNA/RNA", and "The light from the Sun affects the structure of the water which we breathe and drink. This in turn can affect our moods. This was observed in a series of experimental observations carried out for many years. The device used to do this was simple and can be verified by anyone. (Payne, 92)."

Payne's light theories lend a unique angle to the traditional ideas maintained by Vedic astrologers regarding cosmic light. There may indeed be a quality, and a color of light pertaining to each planet, affecting us directly, and/or through our subtle bodies. Before scoffing off the importance of cosmic light, the reader should first ask him/herself: what would happen if the Sun didn't rise?

Possibly, the more obvious Sun and Moon light is imbued with qualitative vibrational influences, due to some interaction with the planets, best explained by Seymour's theories. Vedic astrologers hold that each planet projects its own color of astral light. The excesses and deficiencies of these astral colors within our being may create serious difficulty. Is it really so strange to imagine that we might be permanently imprinted with the unique light pattern of the solar system under which we drew our first breath?

Astrological tradition suggests that the first receiving centers for this astral light may be located in our 'astral body', a supposed body

of subtle matter permeating and surrounding our dense bodies. Russian researcher Semyon Davidovich Kirlian photographed at least one of these subtle bodies (tradition holds that there are several, but this is too great a matter for this article). Curiously, he found that whereas sunlight takes eight minutes to reach the dense physical body, it immediately reached the astral body.¹⁷

TOWARDS A COLLABORATIVE HYPOTHESES

The why and how of astrological inheritance has many answers. Each researcher has been examining only his/her part of their proverbial elephant. However, the combined thoughts of Gauquelin, Kolisko, Hill, Steiner, Lakhovsky, and Payne improve our understanding of astrogenetic mechanisms and better answer the three questions put forth in this article. Following is an explanation of astrogenetic phenomena. These new collaborative hypotheses are synthesized from the ideas the researchers listed above, plus those of Steiner, Cayce, and traditional astrology.

The Internal Response

Planetary radiations of a largely unknown order reach us through the solar wind, (Payne, others) and also through the immediate interaction with the charged particles, (or "plasma") of earth's magnetosphere, there amplified through vibrational resonance (Seymour), and other mechanisms as described by Seymour.

Select metals in solution readily respond to select planetary motion (Kolisko). Humans vary as to the amount and distribution of their bodily metals⁷. Each bodily metal acts as a receiving device for the specialized type of (as yet unknown) radiation from its traditionally associated planet. This reception of radiation is most probably accomplished through vibrational resonance. The subtle distribution of your bodily metals may predispose your planetary reactivity toward one planet over another (Hill).

All cells of the body also receive, store and transmit cosmic and terrestrial radiation of many types (Lakhovsky).

Planetary radiation is received varying, depending on the angle of the planet to the earth locus at a given moment. (traditional astrology, and science). There are sectors of diurnal motion whereby the radiation of a particular planet are more powerfully "received" by cellular, magnetic and metal receivers within biological organisms (Michel and Françoise Gauquelin^(Notes 4)) in part, science, and traditional astrology. (Note: The areas of greatest strength for each planet differ between Gauquelin and astrology).

Our responsiveness to a planet is both quantitative (strong or weak), and qualitative, i.e. emotionally toned. Quality is also inherent in the vibratory signals we pick up from the planets, and resonate with physically, emotionally, and mentally. On the human level, this "quality of resonance" translates into personality effects and proclivities (Hill).

We inherit a responsiveness to the motions of a particular planet (over another) from one, or both parents, (Gauquelin).

Parturition is triggered when the planet to which we are genetically attuned moves into an area of its diurnal motion where its "signals" are most readily received at the birth locality (Gauquelin — my interpretation). This is not the end of the story, but rather a new beginning.

Birth Influences, External Influences

At the first breath of life, the cellular "radios", the protons within the hydrogen molecules, the bodily metals, and possibly our subtler astral bodies, resonate, vibrationally, with the entire gamut of prevailing planetary radiations, inclusive of planetary light. The planetary light may be transmitted indirectly via Sun and Moon light, or may occur at a vibrational wavelength as yet undetected, and received by our subtle astral bodies. At birth, our cellular, atomic, metallic and astral receiving sets become *phase-locked*, or in some as yet unknown manner, imprinted, or "in step" with, the exact planetary resonances under which we were born. This *resonance imprint* can best be described as though a tuning fork was struck within us at birth that continues to resonate throughout our lives. We are imprinted at birth (through one or all of the suggested mechanisms) with something akin to a photograph, of cosmic vibrational resonance. Astrological sources inform us that this planetary resonance imprint is permanent, i.e. the birth chart can be referred to for information through out the life of its possessor.

Through the mechanism of a sustained or memorized resonance imprint, we maintain within us the full complexity of the vibrational music of our birth planets. This "internal resonance record" is both qualitative and quantitative. The relative strength and weakness of the planetary birth resonances is quantitative. Quantitatively, a newborn can receive more or less of any particular planet's vibratory quality in his resonance imprint. The relative proportions of his/her planetary resonances will describe his/her character, and proclivities. The vibrational character of our planetary (and seasonal) imprint provides the quality, or flavor of our response perhaps best seen as "personality" (Hill, tradition).

Again, our permanent planetary vibratory resonance imprint effects, through the quality, or "tone" of vibratory frequency, our character, appearance, interests, health, etc. The qualitative effect of cosmic resonance is what the astrologer interprets when she "reads" your birth chart. (Collaborative ideas from all sources, plus traditional astrology). The birth chart can be said to be a diagram of your permanent planetary resonance imprint.

Furthermore, the DNA, as it existed at birth, can possibly undergo alteration, due to changes in the Sun's light (Payne), or through planetary radiations, vibrationally received by the physical and subtle bodies, through vibrational resonance (Hill).

Our planetary birth charts reflect our genetic heritage, and they also display the relative strength of planetary radiations, magnetism, and light patterns available at the moment of birth (tradition).

The planetary birth chart could best be described as a solar, lunar, planetary, and seasonal resonance imprint. It is plausible that this "imprinting" may go on for several minutes, a theory anecdotally "proven", by case studies of individual birth charts (Hill).

Additionally, our response to planetary radiation, magnetic and light patterning is not entirely an entirely dense physical affair. The disembodied soul^(Notes 5) is attracted at birth to distinct planetary patterns for the karmic and spiritual opportunities they represent. Like souls (parent and child) are attracted to like planetary patterns. And we must not overlook the idea that the soul's opportunities as represented by the astrological birth chart, are inclusive of one's unique genetic inheritance (Steiner, Cayce, tradition). We have come full circle.

SUMMARY

Future astrologers may not speak poetically of "Piscean" or "Martian" energy, but instead, of various classifications of cosmic, planetary and seasonal radiation, as well as of subtle magnetic wavelengths. Neither will they speak of astrological "houses", but instead, of precise sectors of diurnal motion.

The old astrological jargon will be replaced with language reminiscent of electronic engineers. However, perhaps we shall then lose the mystery and wonder of ancient astrology.

The field of astrogenetics remains an uncharted sea. Hopefully, my suggested research criteria, case studies, and summarization of mechanistic hypotheses will inspire new research of provocative subject. ■

References

- 1A) Michael Gauquelin, *The Cosmic Clocks*, Avon NYC, 1969.
- 1B) Michael Gauquelin, *L'Heredité Planetaire*, Denoel, Paris, 1966, pp 92-93.
- 1C) Michael Gauquelin, *Birthtimes*, Hill and Wang, NY 1983.
- 2) Paul Coisnard, *La Hol d'Heredité Astrale*. Chornac. Paris. 1919.
- 3) Karl E. Krafft, *Traité d'Astrobiologies*, Legrand, Paris, 1939.
- 4A) Judith Hill and Mark Pout, "Correlation of Earthquakes with Planetary Positions", *NCGR Journal*, Winter 86/87, Stamford, CT.
- 4B) Judith Hill, "The Regional Factor in Planetary Seismic Correlation", *American Astrology*, reprinted by Borderland Research Sciences Foundation, 1996.
- 5) *Above&Below*, Issue 12, Winter/Spring 88/89, Toronto, Ontario, CN.
- 6A) Judith A. Hill and Jacalyn Thompson, "The Mars-Redhead Link" *NCGR Journal*, Winter 88-89.
- 6B) Judith A. Hill, "Commentary on the John Addey Redhead Data", *NCGR Journal*. Winter 88-89.
- 6C) Judith A. Hill, "The Mars Redhead Link II: Mars Distribution Patterns in Redhead Populations", *Borderlands - A Quarterly Journal of Borderland Research*, Vol LI, No 1 (part one) and Vol LI, No 2 (part two).
- 6D) Mike O'Neill B.Sc., "Time-Switching Control Applied to Hill and Thompson's Redhead Data", *Correlation*, June 1991.
- 6E) Beverly Steffert, Ph.D., "The Mars-Redhead Link under Attack", *AAJ*, England*.
- 6F) Mary Downing, "The Redhead Log", *NCGR Journal*, Winter 88-89.
- 6G) Judith A. Hill, "Redheads and Mars: A Scientific Testimony" *The Mountain Astrologer*, May, 1996.
- 6H) Judith A. Hill, "Medical Anomalies and the Mars-Redhead Link", *NCGR Journal*, Winter 88-89.
- 7) Nick Kollerstrom, *The Metal Planet Relationship*, Borderland Sciences Research Foundation, 1993.
- 8) Penny Thornton, *The Forces of Destiny*, Weidenfield and Nicklolson Limited, London, 1990.
- 9) Michael Theroux, *The Rhythmic Formative Forces of Music*, Borderlands Research Sciences Foundation, 1995.
- 10) Percy Seymour, *Astrology the Evidence of Science*.
- 11) Buryl Payne, Ph.D., *Jupiter-Uranus: The Social Power Planets*, Newsletter, Summer 96.
- 12) Georges Lakhovsky, *The Secret of Life: Cosmic Rays and Radiations of Living Beings*, 1939, reprinted by Borderland Sciences Research Foundation, Bayside, California.
- 13) Dr. Gouri Shanker Kapoor, *Gems and Astrology*, Ranjan Publications, 1985, New Delhi.
- 14) Harish Johari, *The Healing Power of Gemstones in Tantra, Ayurveda, Astrology*, Destiny Books, 1988, Rochester, VT.

15) James Braha, *Ancient Hindu Astrology for the Modern Western Astrologer*, Hermetician Press, 1986, Miami, FL.

16) Paramahansa Yogananda, *The Autobiography of a Yogi*.

17) Peter Tompkins and Christopher Bird, *The Secret Life of Plants*, Harper and Row, New York, 1973.

18) Francoise Gauquelin, "The Nycthemeral Expectancy", *Astro-Psychological Problems*, 1985.

19) Judith A. Hill, *The Astrological Body Types: Face, Form & Expression*, Borderland Research Sciences Foundation, 1996.

20) John Addey, *Harmonics*, Cambridge Circle Limited, Green Bay, WI, 1977.

21A) Arthur Young, *The Geometry of Meaning*, Robert Briggs & Associates, 1976.

21B) Arthur Young, *The Reflexive Universe*, Robert Briggs & Associates.

Notes

1) Michel Gauquelin "plus zones" are 30 degree sectors of a planet's diurnal motion occurring:

A) Immediately following, in clockwise direction, the "Ascendant" of the birth chart: (the point where the ecliptic intersects the horizon at the birth moment); and,

B) it's opposite sector 180 degrees away (See Figures 1A and B).

C) Immediately following (clockwise) the "Mid heaven" of the birth chart: (the point of intersection between the Meridian and the ecliptic, due South); and,

D) its opposite sector 180 degrees away, preceding the Nadir.

2) A) Claudius Ptolemy, *Tetrobiblos*, 140 A.D. Book the Third, Chapter 16, The Form and Temperament of the Body: "Mars ascending gives a fair ruddiness to the person... and the hair of the head light or red..."

B) William Lilly, *The Introduction to Astrology*, 1647, Chapter 7, Of the Planet Mars and His Several Significations: "...their hair red or sandy and may be crisp or curling..."

C) Brihat Parasara Hora Sastra, Chapter 3, *Planetary Character and Description*, pg. 322, Description of Mars: "Mars has blood red eyes..."

D) William Benham, *The Laws of Scientific Hand Reading*, 1946, (Hawthorn Books, NY), Chapter 23, page 284: "The Martian... the hair is short, stiff, sometimes curly and of an auburn or red color."

E) Sepharial, *The Manual of Astrology*, Wholesale Book Corp, NYC, 1972, Book 2, Chapter 1, The Bodily Form, Defects and Accidents: "...Mars exactly rising produces red hair."

F) Alan Leo, *The Art of Synthesis, The Astrologer's Library*, NY, 1978 (first pub.1913), Chapter 8, Mars the Energizer: "...Mars represents a person who is active, strong, energetic, muscular,... hair sometimes red, but not invariably so, occasionally black and often curly or wiry."

G) *History and Astrology*, Edited by Annabella Kitson, Unwin Hyman Limited, London 1989, Chapter 2, pg 20, Questions About Theft: "If his indicator is Mars, then he will be red in color with reddish, lanky hair..."

H) *Cornell's Encyclopedia of Medical Astrology*, Llewellyn Publications and Samuel Weiser, NY 1972, pg 280, Freckles: "...and Mars rising, or a Mars influence or sign in the Asc.; Mars rising tends to give a full face of freckles, and fiery red hair..."

3) Francoise Gauquelin equally participated in Michel Gauquelin's later research discoveries. Ret 1C,18

4) "Disembody" refers only to the dense physical Tradition suggests that the human soul possesses a spherical light body of unknown origin and composition. Sensitives observe this body. The light body is probably identical with "the aura", but different from Kirlian's photographed "etheric", or "astral" body, a seeming duplicate, in fine matter, of the dense body witnessed in moat of earth's biological life forms.

NEW BOOKS



ON THE TRACK OF WATER'S SECRETS

From Viktor Schauberger to Johann Grander

Hans Kronberger and Siegbert Lattacher

Television journalist Hans Kronberger investigates the research and observations of some of the most important scientist/naturalists who have dealt with the secrets of water; especially the work of Viktor Schauberger and Johann Grander. He delves into such aspects as the "memory" of water, the revitalization of water, reviving "dead" water, and liquid manure revitalization. Kronberger and his writing partner, Siegbert Lattacher, have put together a wonderful account of their findings and offer an entertaining synopsis on this important subject. Includes color pictures, a bibliography, and a list of resources. Highly recommended.

#B0360, 173pp, hardbound, ... \$30.00

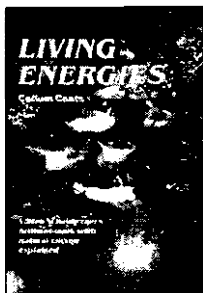

LIVING ENERGIES

Callum Coats

Former architect, Callum Coats, has succeeded in locating and re-assembling the scattered work of Viktor Schauberger and translating it into English. In *Living Energies* he has made these complex and inter-related ideas entirely comprehensible and forms the basis for a new eco-technology which no longer fights nature but has learned to work in harmony with her. This excellent text follows the highly acclaimed book on Schauberger's work, *Living Water* by Olof Alexandersson.

#B0352, 311pp, paperback, ... \$19.95

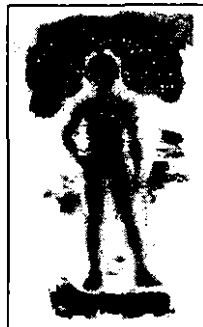

DIMENSIONS OF RADIONICS

David V. Tansley, in collaboration with Malcolm Rae and Aubrey T. Westlake

Written by some of the foremost scholars in the field, this volume has become a definitive manual on the subject. It details the subtle energies and constitution of the human body. Emphasis is placed upon diagnosis of the spiritual, mental, and physical qualities of the individual via the ether fields (distance from the subject has no bearing); and the broadcasting of subtle energies (homeopathic, flower essence, color, and gemstone) back to the subject, thus returning a balanced and tuned system. Instructions cover the use of Malcolm Rae's homeopathic potency stimulators, including those which have an extended range. Illustrated with many charts and diagrams.

#B0357, 206pp, ... \$17.95



THE DIVINING HAND

The 550-Year-Old Mystery of Dowsing

Christopher Bird

"To dowse," says the author of this definitive study of the divining art, "is to search with the aid of a hand-held instrument such as a forked stick or a pendular bob on the end of a string - for anything: subterranean water flowing in a narrow underground fissure, a pool of oil or a vein of mineral ore, a buried sewer pipe or electrical cable, an airplane downed in a mountain wilderness, a disabled ship helplessly adrift in a gale, a lost wallet or dog, a missing person, or perhaps a buried treasure. Co-author of *The Secret Life of Plants*, Christopher Bird has filled this book with exciting, documented stories, most of them illustrated with photographs and diagrams. It provides a complete history of the art of dowsing around the world and discusses in detail the various existing theories attempting to explain this extraordinary phenomenon.

#B0347, 372pp, large paperback, ... \$29.95

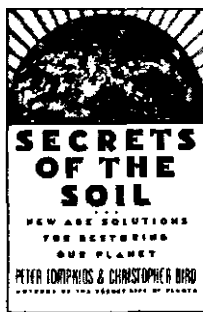

SECRETS OF THE SOIL

New Age Solutions for Restoring our Planet

Peter Tompkins and Christopher Bird.

Secrets of the Soil tells the fascinating story of the innovative, nontraditional, often surprising things that certain scientists, farmers and mystics are doing to save our planet from self-destruction - such as using the techniques of Rudolf Steiner's biodynamic agriculture with its reliance on ethereal forces from the planets, Dan Carlson's growth-stimulating Sonic Bloom, and rock dust as fertilizer to revitalize depleted soils; or gardening with the help of devas and nature spirits, and applying psychic skills to reverse serious agricultural problems.

#B0346, 444pp, paperback, ... \$16.00

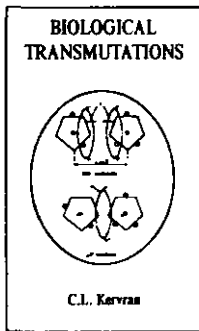

BIOLOGICAL TRANSMUTATIONS

C.L. Kervran

From 1935 to 1955, in an investigation into effects on man of the conditions in which he lives and works, C. L. Kervran was able to study some clear cases of intoxication caused by carbon monoxide when no one was able to detect CO in the air the men were breathing. It was not until 1955 that he determined the cause. For four years he undertook systematic research which ended by confirming that nature is capable of transmuting elements. The problems of ecology, medicine and nutrition, and the alarming rise of radioactivity are too acute to be dealt with solely through academic channels. The understanding of the biological transmutations requires nothing more than the casting aside of all rigid thought while studying them. Transmutations are now recognized in medicine. They have opened the door to new treatments and therapeutics for reputedly "incurable" diseases. Agronomists are already practicing Kervran's findings on a large scale. Mr. Kervran, with his discovery of biological transmutation, has given this chaotic and scientific world the Alladin's Lamp by which we can save ourselves and our diseased earth. #B0345, 134pp, hardbound, ... \$14.95

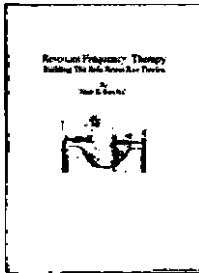

RESONANT FREQUENCY THERAPY

Building the Rife Beam Ray Device

James E. Bare, DC

This groundbreaking book includes a complete set of instructions on the construction of a modern version of the Rife Beam Ray Device. Also included is a list of components with directions on how to obtain, modify, and assemble them to create a fully functioning Beam Ray Device. "If you are interested in Rife's work...drop what you are doing and buy this book!" — Peter Lindemann.

#B0344, 80pp, spiralbound, ... \$25.00



AQUAVIDEO

Locating Underground Water

Verne L. Cameron, Edited and prepared by Bill Cox.

Here, Verne Cameron, considered one of the great dowsing masters of modern times, reveals his inner-most secrets. He lifts the veil of superstition, while exploding Dowsing fallacies. Learn to locate hidden sources of water, oil, treasure, metals, precious stones, and objects (including lost persons, animals, and moving targets). Learn to read signs leading to underground ojas, interconnecting circles, ovals, and rectangular fissures, geysers, cold springs, ascending waters, mineral, and hot springs. Learn to detect sub-surface obstructions, dikes, angular rifts, and water-bearing earthquake faults. Learn how to use the wand or rod, forked-switch, pendulum, water compass, Cameron Aurameter, the "witness," and a wide-variety of water-locating doodlebugs. Cameron explains the relationship between Dowsing and Radiesthesia; the nature of strange "devil rings," noxious earth rays and more. #B0351, 128pp, paperback, ... \$11.95

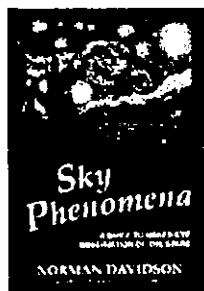

SKY PHENOMENA

A Guide to Naked-Eye Observation of the Stars

Norman Davidson.

Sky Phenomena is an unusual and practical guide to the sky as we see it—with the naked eye. The author leads the student/reader from the appearance of the stars as seen from Earth, through observation of the Sun, Moon, and planets, to a deeper understanding of the Copernican revolution, comets and meteors. The text includes mythological and historical aspects, a unique collection of poetry, and appendices dealing with future astronomical events, technical data, materials and publications, and a comprehensive glossary of astronomical terms. #B0353, 208pp, paperback, ... \$19.95



PRODIGAL GENIUS

The Life of Nikola Tesla

John J. O'Neill

Pulitzer Prize winner John J. O'Neill presents a penetrating study of the life and mind of a scientific superman, Nikola Tesla. A brilliant eccentric, Tesla's life has the quality of the strangest romance. He made his first million before he was forty, yet gave up the royalties on his most profitable invention as a gesture of friendship, and died almost in poverty. Handsome, magnetic, and elegant, he was the "catch" of New York society, yet no woman could win him from his dedication to science. He refused to accept the Nobel Prize; and when others claimed credit for the revolutionary ideas his extraordinary mind threw forth, he did not contest them. O'Neill has written the definitive biography on Nikola Tesla. This is a must-have for anyone even mildly interested in Tesla's legacy. #B0254, 329pp, paperback, ... \$9.00

energies DO exist outside the conventional electromagnetic spectrum of which our finest examples may be found in the sciences of radionics, homeopathy, dowsing, radiesthesia, and etheric engineering to name a few. We will use the all encompassing term "vital force" where it is necessary to reference these energies which have been given many names over the course of historical experiment. That this vital force is biodynamic in character cannot be disputed, and will be designated as such whenever describing these "signals". While conventional modes of discovering these signals has in the past relied on the human subject as an integral component of detection, i.e. the use of the stick plate, pendulum, l-rod, etc., we are concerned here with what has been referred to as the "automatic detecting instrument" - sans human subject.

There is already a great wealth of information on such instruments, much of which has been compiled in the book, *Automated Detecting Devices*, by Jorge Resines. Those wishing for a more extensive bibliography should consult Mr. Resines' publication. For our current purposes it is necessary to confine ourselves only to those instruments which we ourselves have experimentally verified, and these will be the methods detailed here. Our investigations into the detection of biodynamic signals begins with the outstanding work of L. George Lawrence.

L. George Lawrence, a Silesian-born electronics specialist, began his studies into plant biodynamics in 1962 while employed as a instrumentation engineer for a Los Angeles space-science corporation. He was actually engaged in a project to develop jam-proof missile components, and believed that using plant tissue as a type of transducer would produce the desired results. He summarized that living plant tissues or leaves were capable of simultaneously sensing temperature change, gravitational variation, electromagnetic fields, and a host of other environmental effects — an ability no known mechanical sensor possessed. These initial investigations led him to the works of Alexander Gurwitsch, a Russian histologist, whose experiments in the 1920s proved that all living cells produce invisible radiations of a biodynamic character. While observing the cells of onion roots, Gurwitsch noticed that they began dividing with a distinct rhythm causing him to trust that some type of vital force from nearby cells was the cause. To verify this hypothesis Gurwitsch devised a type of ray gun which entailed mounting an onion root tip inside of a thin glass cylinder which was then aimed at a matching arrangement with a small area of onion root exposed to act as a target. Gurwitsch allowed the onion "ray gun" to bombard the sample for three hours, at which time he examined the target specimen under his microscope. The number of cell divisions in the irradiated area had increased by 25 percent! Gurwitsch tried to block the emanations with a thin slice of quartz crystal, but this proved ineffective. Only glass or a gelatin substance guaranteed blocking the transmissions. Owing to the fact that these rays from the onion "ray gun" demonstrated increased cell division or mitosis in the target, Gurwitsch called them "mitogenetic rays." Many other laboratories would confirm his findings. Researchers in Paris, Moscow, Berlin, and Frankfurt all corroborated Gurwitsch's results. Only the U.S. Academy of Sciences reported that Gurwitsch's discovery was not replicable, and suggested it was merely his fertile imagination.

This system of being able to manage and direct the vital force in living plant tissue sparked Lawrence into action. Equipped with the

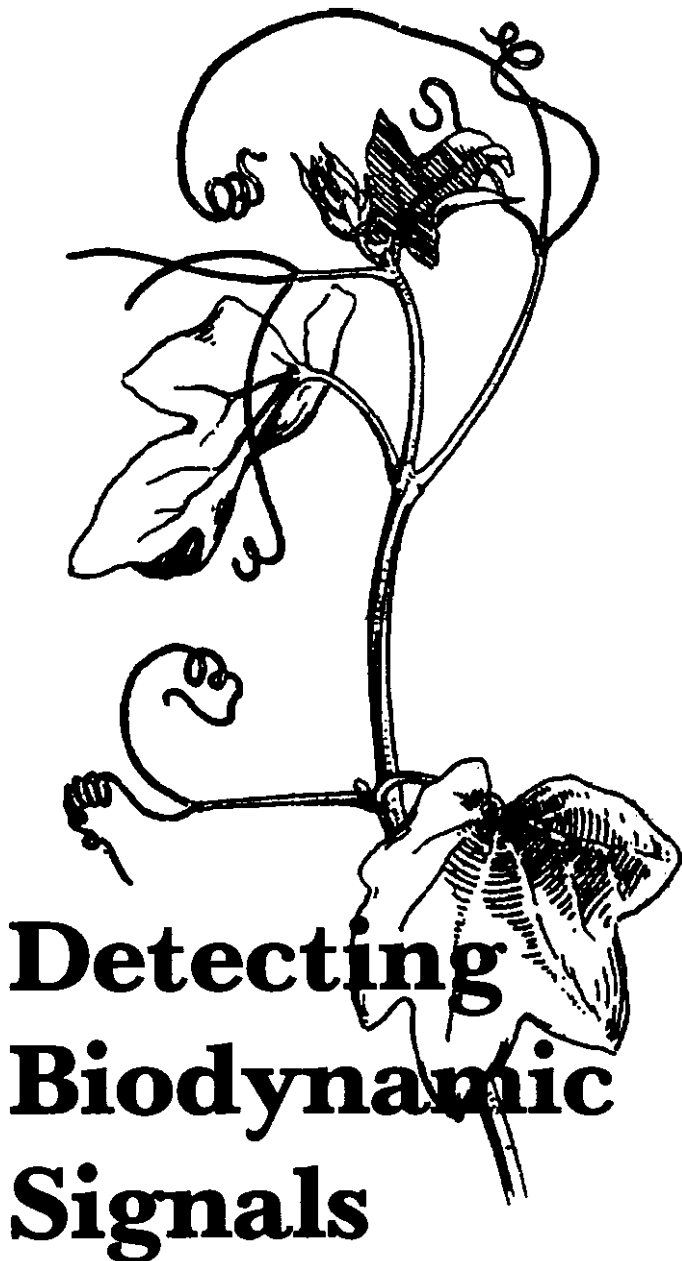

Detecting Biodynamic Signals

Part I

by Michael Theroux

THE means to detect communications and energies which exist outside of the electromagnetic spectrum has been an enduring quest of qualitative researchers for many years. The catalogue of these pursuits is indeed a long one and can by no means be completed here, but we will attempt to cover historically those researches which warrant our attentions, based on the value of the attained results. We will also include research currently being done by BSRF and others.

Much evidence indicates that specific communications and

knowledge of Cleve Backster's recent experiments with plants and a polygraph instrument, Lawrence began building several psychogalvanic analyzers to detect responses in plants. He quickly corroborated the results that Backster had obtained from his plant experiments—these results indicating that plants displayed a unique cellular consciousness. Over the course of his experiments, Lawrence would begin to modify the basic recording apparatus from the simple galvanic skin response indicators, to ultra-high-gain piezoelectrometers. He also did away with the pen recorder, opting for a built-in audio oscillator which produces a steady tone, changing to distinct pulsations when the plant sensor is activated by external stimulation. Aural monitoring has many advantages over the pen recorder, chief of which is the relative ease with which one can oversee (hear) the plant's response. Another feature Lawrence would bring to the field was the replacement of the test plant with biologically active sensors, or "biodynamic transducers". These could range from simple tubes containing vegetal material in a temperature controlled bath, to thin AT-cut quartz crystal wafers bonded with specific organic materials housed in a Faraday chamber. In the latter device, the highly reactive organic material induces changes in the crystal, which when used in an oscillator circuit, will alter the oscillator's frequency.

Lawrence preferred to perform his experiments in what he called "electromagnetic 'deep fringe' areas", where there were no man-made interferences. The remote locations of the high desert in southern California were his favored haunts for these investigations. In October of 1971, Lawrence was working on an experiment near Temecula, California. He had developed an instrument which would receive a directional biodynamic signal from a distance of up to one mile away. This instrument consisted of a lensless tube which housed a cylindrical Faraday chamber. The base of this tube contained a biodynamic transducer which was connected to the recording instrumentation. The complete "biosensor" tube was mounted on top of a low power telescope for directional sighting. To induce a stimulus into the directional biosensor, Lawrence would train the sights of his instrument on a plant or tree some distance away that had been previously wired with electrodes. These electrodes were connected to a switch which when closed would introduce a pre-measured current into the tree or plant. Back at the test site, Lawrence would then gently electrocute the tree or plant by radio control, causing his biosensor apparatus to respond wildly. This was an exciting new breakthrough in the field of detecting biodynamic signals for the instruments were now directional and worked at a considerable distance. But, this is certainly not the end of the story. On the day of these experiments, Lawrence and his assistant decided to take a late afternoon break. The biosensing instrument had been left on and was pointing in a random direction at the sky. As they began to eat their lunch, the steady sounds from the equipment abruptly changed to the familiar series of pulsations instantly signaling that it was picking up some sort of disturbance. After checking the apparatus and finding no malfunctions, Lawrence determined that the signals had to be coming from outer space! Certainly, these seemingly intelligent gestures from another world would most probably be transmissions of a biological nature, and not from the electromagnetic spectrum which had so consumed the academicians of the CETI project and other outrageously funded government projects! This discovery would remain the primary

focus of all of Lawrence's later experiments with biosensing instruments.

Lawrence had initially determined, based on the direction the instrument was pointing, that these signals originated from the constellation Ursa Major, commonly known as the Big Dipper. Later, after repeating the experiment several times with more elaborate equipment, he speculated that galactic drift may have been involved and that the signals may have been "spilling over" from the galactic equator which hosts a very dense star population. He believed the signals were not directed at earthlings, but were probably transmissions between companion civilizations, which he felt would communicate via "eidetic imagery". This led him to begin analyzing these signals with video recording equipment. The images produced by these signals were called "biograms" and were basically digital spectrograms with a gray-scale resolution of 640 x 482 x 8 bits. Interpretation of these biograms needs considerable study. Unfortunately, there has been little information on this aspect of Lawrence's work, and it seems as though this was to be the last installment of his labors.

The information we have retrieved on L. George Lawrence's achievements is scant at best. Much of it comes from the few articles he wrote, and the brief generalizations from the writers of more popularized books. The whereabouts of his equipment and/or notebooks is not known at this time. An important document for the re-creation of Lawrence's experiments is the movie version of "The Secret Life of Plants". In this video Lawrence is shown at work with his biosensing equipment, and one can hear recordings of the reception of biodynamic signals. One credible resource states that Lawrence was an expert oceanographer, historian, cartographer, and originator of the world's first laser engine. He is credited with the authorship of some 46 books, but we have recently discovered that the name "L. George Lawrence" was a pseudonym he used for his popular works, and only two books bearing that name are to be found. As the managing director of the Ecola Institute in the 1970s, he was engaged in nuclear radiation research, medical and agricultural biomagnetic research, and conceptive space research for NASA among other agencies. It is quite probable that much of the work that Ecola was pursuing was of a confidential or classified nature, possibly funded by military interests, and this would account for the disappearance of notes and equipment. We will include an extensive bibliography at the end of part 2 of this essay, which includes Lawrence's references from his popular articles, so that others may follow up on this fascinating avenue of research.

Over the last year, it has been a project of ours at BSRF to recreate and elaborate on the many innovations brought to our attention by L. George Lawrence. We began with the basics using simple psychogalvanic instruments to analyze plant responses, and in the process, were able to recreate several of the results obtained by pioneers in plant research. Many of these recreations and new discoveries have been chronicled in the column, "The Borderland Experimenter" and elsewhere in this journal. The impetus which directed our experiments toward those of Lawrence was the fact that he was able to obtain directional and "wireless" biodynamic signals over great distances.

The primary setup consists of a Faraday tube with an organic "biosensor" housed at its base. A rotating beam splitter at the end of the tube further cancels out interference from stray electromag-

PARTS LIST FOR PLANT RESPONSE DETECTOR

RESISTORS

R1 - 75k
R2 - 10k Linear Potentiometer
R3 - 100k Linear Potentiometer
R4, R5, R14 - 1k
R6 - 240k
R7 - 1M Linear Potentiometer
R8 - 82 ohm
R9, R10 - 470k
R11 - 3.3k
R12 - 10k
R13 - 4.7k
R15 - 100 ohm
R16 3.5 ohm 1 watt
R17 - 10 ohm
R18 - 8 ohm potentiometer (L-pad)
(all resistors ½watt unless specified)

CAPACITORS

C1 - .05μF
C2, C3 - 50μF 10 volt electrolytic
C4 - 220 pF
C5 - .01μF
C6 - .005μF

TRANSISTORS

Q1 - SK3011 transistor
Q2 - SK3003 transistor

OTHER

IC1 - μA741C op amp (Radio Shack 276-007)
D1, D2 - IN4004 Silicon Diode
B1, B2, B3 - 9v battery (with holders & clips)
B4 - 1.5v D-cell (with holder)
M1 - 0-1mA meter
P1 - RCA (male) plug
J1, J2 - gold fem. RCA jack
T1 - Audio transformer 250/8 ohm, 200mW
Spkr - 3.2 ohm
I1 - 2.2v lamp #222
S1, S4, S7 - dpdt switch
S2, S3, S5 - spst switch
S6 - Normally open pushbutton switch

3 feet of shielded two-conductor wire
project case
8-pin IC socket
perf board or etched circuit boards
knobs for potentiometers

netic radiations. The most significant problem concerning this portion of the equipment is determining what will be the most suitable material for the biosensor itself. Originally, sections of plant leaves were used which had the electrodes clamped to them in the traditional manner. This proves to be a cumbersome procedure, and the plant material clamped as such quickly becomes stressed and ceases to respond at all. Hundreds of different "non-plant" substances have been tested in biosensor designs, all failing in their capacity to produce the dynamic response of living materials. Unfortunately, Lawrence left few clues as to what would be the

optimum arrangement here. We know that in his early work, Lawrence used a variety of mustard seeds floating in a nutrient bath for the reception of biodynamic signals. In later years, he would speak of using thin sections of plant stems or roots as a biodynamic transducer. Our finest results were obtained using this arrangement.

Next, the output of the biodynamic transducer is connected to the electronics package which can consist of a simple psycho-galvanic response indicator, to a more sophisticated adaptation which is shown in the schematic here. One can see this system described in many of Lawrence's articles and in use on the aforementioned video documentation. The advantage of this system over the simple biomonitor is that it affords greater selectivity with regard to sensitivity when monitoring signals. The drawback is that since these more sensitive units are not a production item, one must be somewhat skilled at building electronic instrumentation. Unfortunately, there is not enough room here to give step by step instructions on the construction of such a project from a schematic diagram for those with little knowledge in electronics manufacture. The basic details of the circuit's operation will be covered here, but some understanding of schematics and components is assumed.

The instrument designed by Lawrence has both a visual meter and an acoustical output indicator through a speaker. The audio tone output can also be directly connected to a tape recorder. A simple modification will allow one to connect the d.c. output to a pen recorder to make a permanent record of the retrieved signals. The connections to the biosensor or plant material may be done any number of ways already discussed.

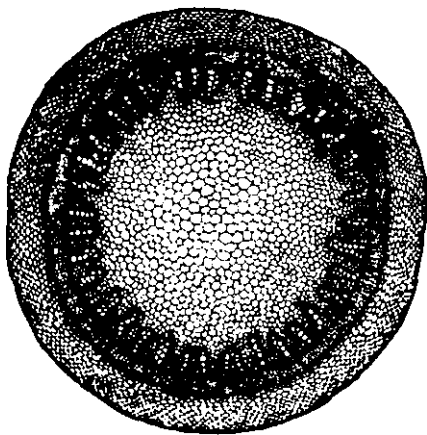

A cross-section of a plant stem used as a biodynamic transducer

PLANT RESPONSE DETECTOR BASED ON A DESIGN BY L. GEORGE LAWRENCE

WHEATSTONE BRIDGE SECTION

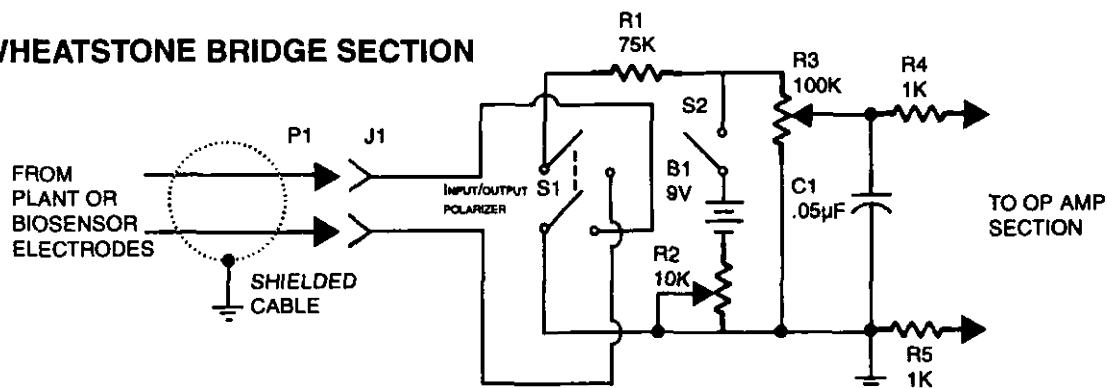

OP AMP SECTION

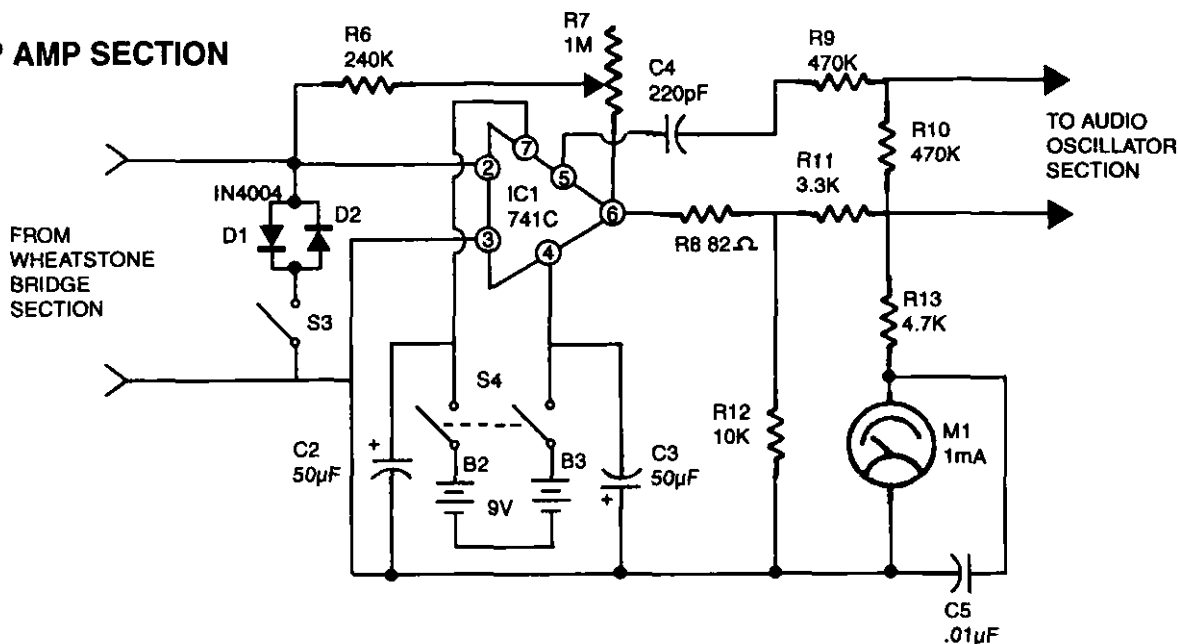

AUDIO OSCILLATOR SECTION

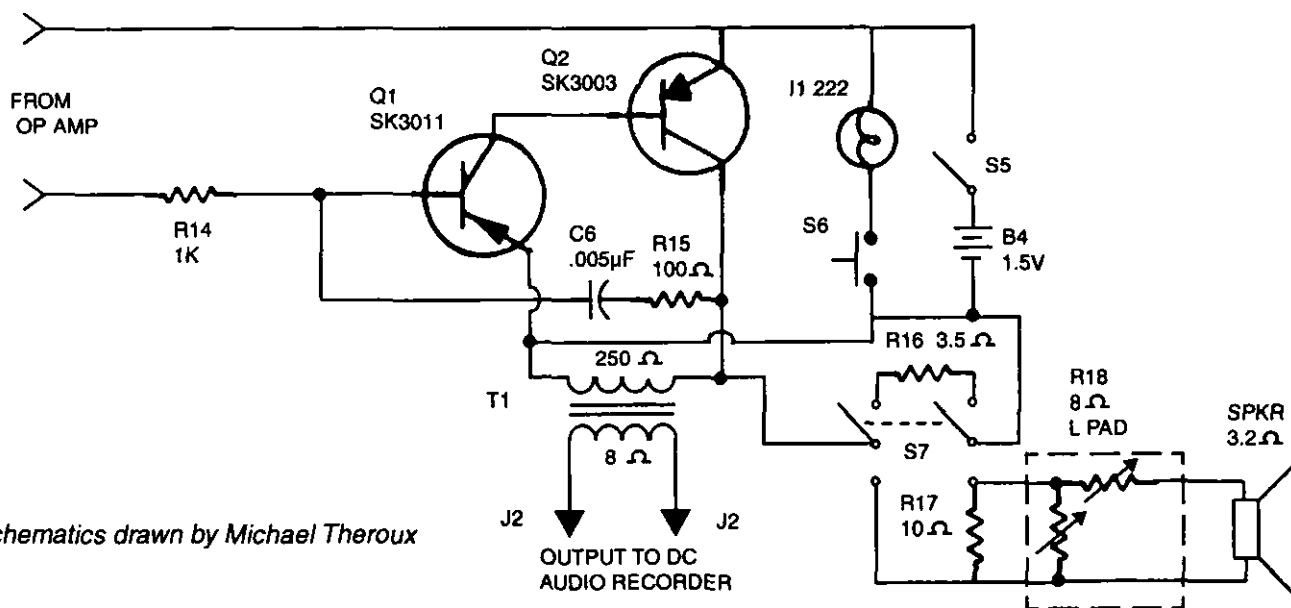

Schematics drawn by Michael Theroux

Biodynamic Response Detector - Circuit Theory

Referring to the schematic, we will begin with the Wheatstone bridge section. The biosensor connected to input J1 forms part of a Wheatstone bridge with the other legs formed by R1 and R3. Power to the bridge is furnished by B1, which is controlled by R2. Switch S1 is an input/output polarizer which permits reversal of the current or excitation applied to the biosensor. This is most important, as the setting of S1 will determine whether the plant's own generated currents will be superimposed upon the excitation currents.

The signal from the bridge is then amplified in IC1, which is protected from large signals by diodes D1 and D2 when switch S3 is closed. After the circuit is completely operational, S3 may be opened for maximum sensitivity. Power to the amp is given by B2 and B3 operated by switch S4. The output of the amplifier is indicated on meter M1, which is null adjusted by R3.

The amplified output also drives an audio oscillator (Q1 & Q2) whose fluctuation of frequency is a function of the signal from the biosensor/bridge arrangement. Indicator lamp I1 lights up when activated by the momentary pushbutton switch S6, and allows testing of battery function as well as the cueing of a mark on the tape being recorded due to the pitch increase as S6 is depressed. Transformer T1 supplies an audio output for the tape recorder, S7 turns the speaker on and off, and R18 adjusts the volume of the speaker.

After the successful construction of the instrument, one is ready to perform experiments. S3 should begin in the closed position to prevent excessive input signal going to IC1. Next, S1 should be turned on to apply current to the biosensor/bridge, which is adjusted by R2. S4 should be turned on next, followed by the adjustment of R3 for a meter null (zero setting). This will have to be readjusted occasionally as the biosensor or plant settles into its baseline

(relaxed) condition. Indications of biosensor response will be observed on the meter, and in the fluctuations of the audio tone coming from the speaker. The actual amount of excitation controlled by R2, and the state of the superimposition of plant currents must be determined by actual usage. Performing these experiments in an area of low electromagnetic interference is ideal, but is not necessary unless one needs to control any outside influences. Armed with this instrument, one should be able to conduct a wide variety of unique experiments.

This concludes Part I of this article. Part II will detail advancements concerning these experiments, the introduction of "biograms", and other instruments designed specifically for the detection and analysis of biodynamic signals. ■

Selected References

"Electronics and the Living Plant", L. George Lawrence, *Popular Electronics*, October 1969.

"Electronics and the Living Plant", L. George Lawrence, *Electronics World*, October 1969.

"Experimental Electro-culture", L. George Lawrence, *Popular Electronics*, February 1971.

"More Experiments in Electro-culture", L. George Lawrence, *Popular Electronics*, June 1971.

"Are We Receiving Biological Signals from Outer Space?", L. George Lawrence, *Popular Electronics*, April 1991.

The Secret Life of Plants, Peter Tompkins and Christopher Bird, Harper & Row, 1973.

"Contact with Extraterrestrial Life", Joseph F. Goodavage, *Saga Magazine*, January 1973.

When Stars Look Down, George W. Van Tassel, Kruckeberg Press, 1976.



PLANT TONES

New!

MUSIC FROM THE WORLD OF PLANTS

Michael Theroux

Ever wonder what a plant might sound like if it could talk or sing? On this audio cassette you'll hear what could be the encrypted communications of the plant world. Using the biological reactions of several species of plants, Michael Theroux has translated them into audio sounds via recordings, which when mixed together produce a variety of never before heard "plant songs". Some of these "songs" are the excited responses of plants to being watered, while others were plants stimulated with music, conversation, or simply nothing at all! Some listeners may find these songs disturbing or even haunting as they evoke an intellect not generally associated with plants. These are truly sounds from another world, but some of you may find you understand what the plants are saying!

Plant Tones - Music from the World of Plants

Available from Borderlands #C0015, Audio cassette, 30 mins., ... **\$10.95**
(Please include \$3 for postage and handling)

The Broadcast Power of Nikola Tesla

Part II

by Gerry Vassilatou

COMPLETING a tour of the major scientific institutes in America, Tesla expected to retire for a season of rest in New York once again. News of his advancements however, flooded every technical trade journal. The name Tesla was everywhere *once again*. *First polyphase and now radiant electricity*. He was the "darling" of the press. Tesla captured the public eye once again. People everywhere were thrilled with the projected future visions which Tesla freely provided. He was a model European immigrant, suave and debonair. These are probably the qualities which first attracted Anne Morgan. Irresistible, wealthy, unattached, and warm. Tesla was her obsession.

Despite his great personal charm and magnetic personality, he maintained his serious tone and poise wherever he went. The vision of the future was far more important than the attentions of a young and flirtatious lady. In anticipation of these forthcoming events, Tesla often invited other socially esteemed guests to his laboratory for special demonstrations. In this manner, it was noised abroad that what he claimed was in fact real. Anne often attended these gatherings, breathing silently in the shadows of his large loft laboratory.

There were others who, although not attending these demonstrations, were equally watchful of Tesla's newest radiant energy developments. Several of these persons, shall we say, were interested in his new discovery and its implications...because their fortunes were threatened. Tesla had swept the world once with polyphase. He wiped out Edison's Direct Current System overnight. J.P.Morgan, Edison's recent "patron", had lost a considerable sum during that fiasco. It was certain that Tesla would soon sweep the world again with broadcast electricity. This destabilizing influence would not be tolerated. Anne complicated the affair considerably. She was in love with Tesla. Obsessed in fact. Too obsessed and desperate to let go.



ROYAL SOCIETY LECTURES

In the very midst of all these national attentions, Tesla received an invitation from Lord Kelvin. He was formally requested to address the *Royal Society*, his latest findings were earnestly desired. The English, usually extremely conservative, were sure that Tesla would change the course of world history.

Tesla, adjourning from his daily researches now prepared himself for the lectures which would start the world-change. He packed nearly every piece of delicate equipment one can imagine. Vacuum tubes, Transformers, strange motors, and equally strange wireless apparatus. All were carefully crated and personally brought to Europe by Tesla himself. His beloved elder and personal mentor, Sir William Crookes, greeted him.

In the opening portions of his Royal Society lectures Tesla first described his preliminary work with high voltage high frequency alternating currents in some length. He explained that these devices embodied the very last investigations and improvements of his Polyphase System. He demonstrated several of the first small high frequency alternators and iron-core induction coils in order to prepare his audience for a final announcement.

In this very last dramatic demonstration Tesla revealed to British Academia the disruptive electric discharge and the properties of electric rays. Tesla made a rare and complete "full disclosure" of the electric ray effect at the very end of his lecture. It was the very last time he would ever do so again in academic circles.

Tesla showed that the new radiant electricity was distinctive, having been openly proclaimed during the London Royal Society lectures. Tesla deliberately compared and contrasted the potent impulse radiance to his previous weak effects produced by alternating currents (February 1892). Fluorescent lamps and other luminous wonders held his audience spellbound. All the while his voice, tenor-like by excitement, rang throughout the silent awestruck hall.

He demonstrated wireless lamps, lit to full brilliance by radiant electricity. He ran small motors at sizable distances for his audiences to see. This last lecture represents the only recorded instance in which Tesla openly announced his discovery of the electro-radiant impulse. He tells the personally revolutionizing aspect of his discovery and how it virtually eradicates his previous work. He went to great detail verbally describing and disclosing the exact means for eliciting the phenomenon.

In his closing time Tesla quickly demonstrates special "electrostatic" motors and lamps made to utilize the radiant effect. Examination of these first lamp and vane-motor devices reveals their primitive and initial state. Tesla modelled the motor after the Crookes radiometer, stating this fact publicly for the benefit of his revered mentor. Tesla finally stated the vast implications of the discovery. He pointed their minds toward the establishment of true power transmission.

He prophetically announced the new civilization which would emerge from these first devices and systems. The world would be completely revolutionized by this new principle. Tesla described beam-transmission of electrical energy, and the possibility of harnessing the radiant energies of space itself.

Those who had witnessed Tesla's entire demonstration were completely enthralled at his results, but misunderstood his new announcement completely. This became apparent to Tesla a short while after he, highly decorated and honored, departed for his Parisian tour. British Science was yet delving into Teslaian high frequency alternations. Tesla had already disposed of these discov-

eries as mere preparatory introductions to impulses.

Tesla showed by way of comparison that disruptive field impulse transcendentally exceed all other electro-inductive effects by several orders. He expressed difficulty in discerning whether the effects were electrostatic or electrodynamic in nature, preferring to associate them more with electrostatic effects. We deduce that he had only recently begun developing the electric impulse effect because of his hesitance in identifying the phenomena properly.

Tesla was stringently exact in all his statements. This seems uncharacteristic of his scientific nature. But he did this in true scientific openness. Tesla did not know exactly what was occurring in the electric impulse at that time, desiring only to share the discovery openly and candidly. Academic disapproval of his personal semantics came swiftly in journal after journal.

It is clear that Sir William Crookes completely grasped the significance of Tesla's entire demonstration and realized the closing formal announcement of the new electric force. Crookes could not contain the thrilling implications. He was also sure that the new force would completely revolutionize the scientific world.

Crookes upheld Tesla thereafter as the true discoverer of an unrecognized electrical force. Tesla continued correspondence with his mentor after his departure from England. He had hoped that his dramatic announcement and demonstration would produce a new regime of electrical engineering, and that others would now reproduce the radiant electric effects as described. His hopes would be strangely dashed to pieces in the coming years when the derisive academic attacks began.

To European academes, the lecture series was astounding. It was a glimpse of the future, so clear that few could find time to argue with Tesla at all. Tesla concluded his tour of En-

gland and France, everywhere heralded in typical Victorian heroic style. One night, while in Paris, a telegram informed him that his mother was on point of death. Rushing to her bedside, he managed a few hours of final conversation.

He always referred to her as the one who completely understood his strange abilities. Was she not the woman who had encouraged him when he first remarked about his childhood visions? When siblings and friends derided him, she was his support. Early the next morning, in an adjacent house, he was abruptly awoken by a vision. What he beheld changed his life. A seraphic host surrounded his mother. She was ascending into bright clouds. Several minutes after that, the announcement came. His mother had quietly passed away. He spent a torturous week in his native land for her funeral, and fled back again to New York.

Tesla discovered that excessive sparking, though impressive to observers, were actually "lossy instabilities". The distant radiant effects he desired were interrupted and distorted whenever sparking occurred.

REVERSALS

When English engineers wrote, asking the means for generating his impulse effects, Tesla gave them very strict descriptive parameters. He never failed to openly disclose the secret by which his spectacular effects were obtained. He had learned to freely share what he knew with all. He was surprised to discover that the academic societies who so warmly addressed him in Europe, were *gradually losing interest in his discovery*. Being utterly incapable of duplicating his specified parameters, most believed the effects to be "dubious".

The impulse effect had very stringent requirements before its manifestation. Care in constructing *impulse generators* was the basic requirement. Engineers wanted equations. Tesla gave them descriptions. A few experimenters succeeded in later duplicating Tesla's broadcast electricity effects. But these systems were direct descendants of Tesla's earliest and less efficient designs.

It is often in the nature of academes to forgo empirically evident facts and argue personal differences, especially when foreign personalities are given excessive adulation. Fixated on issues having to do with words and personal poise, Tesla's audiences found several acrid voices whose equally vile publications dared tamper with Tesla's character.

New critics were everywhere, even at home. Dolbear, Thomson, and even Pupin found time to criticize and deride Tesla. Because most younger academes relied entirely on schooling and less on empirical method, they were easily swayed by academic opinion. Tesla underestimated the power of media and of opinions in underrating his abilities. He quickly found that public opinion could actually sway scientific opinion. He failed to see who was behind the media campaign.

Tesla disregarded his antagonistic colleagues. Crookes always deferred to Tesla, whom he admired and loved as a younger protege. Tesla revered the aged Crookes, upon whose confidence he came to rely during more difficult years. Crookes had been given a true Tesla Transformer when Tesla had given his lectures. The small device was potent, giving the uncharacteristic effects which Tesla had always claimed. This single piece of evidence was left in England for all to see. Remarkably, this evidence did not silence the critics.

Tesla could see no reason in all of this. Something did not quite "add up". Even Tesla could see that there was a missing part of the "equation". Discovering this part would explain his own reversals. As if these personally devastating events were not enough for him, the insolent young Anne continued haunting him at his every turn. He continued being "polite" to her, but never more than this.

Crookes wrote many times to the Royal Society and to Tesla concerning this fact. Sure that Tesla was a *modern Faraday*, Crookes continued espousing the belief that Tesla had discovered the next historically important electrical advancement. He was encouraged to continue research despite his protagonists. Few academes trusted Tesla's methods now. Fewer yet listened any longer to his statements.

Losing credibility as quickly as he had found it, financiers were slow to trust investing in his new systems. His inventions continued their steady march into electrical history. Each new device chronicles a new step in the technology which should have changed the world. He plunged himself headlong into work. Only work would vindicate

him. Opinion would fade when others gradually saw the astounding developments which he would produce. In these actions, Tesla revealed his noble and naive nature. The world had changed, but changed toward a more brutish rule.

BROADCAST POWER

He set to work developing more powerful embodiments of his initial Transformers. In order to make a Broadcast Electrical System possible it would be necessary to devise more efficient transformers. He set to work on this very task, examining and dissecting every fundamental part of his existing Transformers.

Tesla discovered that excessive sparking, though impressive to observers, were actually "lossy instabilities". The distant radiant effects he desired were interrupted and distorted whenever sparking occurred. Both sparking and brush discharges actually ruined the distant broadcast effects of *radiant electricity*, a situation which had to be remedied. Tesla sought elimination of the discharges now. Tesla had already found that metals could focus radiant electrical effects. Additional stability in his Transformers could be achieved with the addition of large copper spheres to the active terminals. Tesla considered copper spheres to be "aether gas reservoirs", providing his transmitters with an additional aether gas supply.

Copper spheres attached to Transformer terminals reduced the required electrical levels for an efficient electric radiance. Copper spheres significantly reduced the injurious instabilities of visually spectacular brush discharges, but did not eliminate them entirely. What Tesla required was a new means for transmitting the radiant electricity without loss.

Tests with elevated copper spheres facilitated efficient transfer of radiant power between the Transformer and surrounding space. Now, Tesla Transformers became true Tesla Transmitters. Tesla found it possible to broadcast harmless radiant electricity with great power to very great distances. Numerous subsequent patents recorded his progressive conquest of the broadcast power principle.

He succeeded in making radiant electricity safe for human use. It would simply travel around conductors if made to impulse quickly enough. Only specially entuned receivers could properly intercept the radiant power for utility. Not three years before he had accidentally discovered the radiant electrical effect. He dreamt of safely sending electrical power without wires in 1892. Now, in 1895, he had realized his dream. Would the system work across the vast distances which he envisioned?

He took his more portable Transmitters outdoors, away from the confines of his South Fifth Street laboratory. Both in northern Manhattan and Long Island, Tesla tested his radiant broadcast systems without restriction. He measured the distant radiant electric effects of these designs in electrostatic volts. Broadcast power could be converted back into current electricity if so desired, the harmless high voltage becoming current in appropriate low resistance transformer coils.

He found to his very great surprise that very distantly positioned vacuum tubes could be lit to great white brilliance when the primary system was operating. The requirement for this action was twofold. First both the system and the receivers had to be grounded. Second, specific volumes of copper had to be connected to the receivers. When these two requirements were satisfied, lamps maximized their brilliance, and motors operated with power.

Copper in the receiver had to "match" the copper mass of the transmitter in a very special equivalence, otherwise radiant transfer would not be efficient. The requirements differed very much from those of ordinary radio antennas. He also found that elevated copper spheres more powerfully enhanced the broadcast radiant power from his transmitters. This was Tesla's means by which his transmitters and receivers could be better "connected" despite their distance.

Tesla believed that these electrical beams invisibly linked both his transmitter and receivers together. He considered each as "disconnected terminals" to ground. Electrical radiance spread out in all directions from the elevated copper sphere of his transmitter. The secret in receiving a maximum signal was to match the transmitter's copper mass with the receiver mass. Then, the æther streams would actually focus into the matched receiver. This affinity would take time, the transmitter energy "searching" for better ground sites. Radiant electricity evidenced curiously vegetative "growth characteristics".

Receivers now were outfitted with small copper spheres. These provided a more efficient affinity and absorption for the radiated power. The additional copper spheres which surmounted Tesla transmitters effectively lowered the input electrical power for the production of focussed æther discharges.

Tesla took the gas dynamic analogy to another level when he found that both low pressure gaseous and vacuum tubes could replace copper. Electro-radiant effects from gas-filled globes were projected with less electrical loss and even greater power. Large low pressure argon gas filled globes were empirically found to broadcast tremendous radiance when used atop his transmitters. Additionally, he found that argon gas at low pressures could serve as an equivalent receiver as pure copper spheres.

The gas filled globes would be less costly than copper spheres to disseminate in public use. He was approaching a totally efficient system. Numerous personages were invited to observe these historic tests. J.H. Hammond Jr. was one such individual. Enthralled with Tesla's developments, he and his wife invited Tesla repeatedly to their home in later years. Tesla was their honored guest for months at a time. Later in years, after World War I, both Tesla and Hammond worked on robotics and remote control.

Tesla envisioned small power units for both home and industrial use. The installation and maintenance of these units would require a small monthly fee. Through these wireless units one could draw sufficient power to operate factories and homes alike. Electrical usage could be metered. The superiority of this new broadcast power system was obvious to all who observed it in operation.

Tesla also described the use of these power units for transportation. Transatlantic ships could simply draw their motive power from continental power broadcast stations. Trains and automobiles could be operated by drawing their power. The potential fortunes would soon stimulate financiers to invest heavily in the "coming activity"

In keeping with his publicity-mindedness, several investors were always invited to Tesla's private demonstrations. Tesla knew that their urge to support his new world-shaking venture would become irresistible when once each had beheld his small broadcast power system. The demonstrations were deemed by these individuals as "entertaining", in their typical dry tone. But, he rarely heard from these people again.

Here was a new change. Shy moneymen. A true contradiction.

Their reticence left Tesla in a state of bewilderment. Once, in a ditch, his conversation alone was sufficient perfume to attract the bees. Now? None would dare leap into the new world sea. Why? What sharks were there besides themselves? Tesla could simply not understand this new "dearth", this incredulous conservatism and lack of imagination on the part of New York investors.

Eager to begin, Tesla patiently waited for the messengers to call. Had he known more of the world around him, however, he would have stopped waiting. Shortly after Tesla's private demonstrations were concluded, Morgan's agent approached Tesla with a "business proposition". The bribe being sizable, contracts would have placed Morgan in control of Tesla's new system. Tesla laughed at the pale little Mr. Brown in his pinching-tight tails, informing him that he himself was already a millionaire. Why should he need such an affiliation at all? He was escorted very graciously by the amused Tesla.

While dining in the Waldorf several hours later, a rude interruption informed him that his laboratories were ablaze. The connection between his refusal to bow and the flames which now reached skyward was not made until all was consumed. That night, the world changed completely for Nikola Tesla. He lost everything of his past. Everything. The totality of his technological achievements were burned into vapor. Books, priceless souvenirs, delicate equipment, patents, models, drawings, new pieces of apparatus. Everything was burned. He read the message well.

There was a two week period where he simply vanished. No one could find him. Kolman Czito, his trusted technical foreman and machinist feared for Tesla's life. Katherine Underwood Johnson was beside herself with anguish. She was the wife of a close friend, the only real love of Tesla's life. The fire was meant to kill. It was a message as clear as anyone would need. The assassination attempt failed to kill the intended victim. It certainly did not kill his dreams.

Wherever he was for those two weeks, the dreams were with him. But a part of Nikola Tesla died in the fire. It was the part which was tied to the past. His eyes on the future, Tesla developed his discovery into a major technology which the world seems to have forgotten. Of all those who prayed and wept over Tesla's disappearance, one person was no longer concerned. Never again would Anne need to be troubled by the thought of Nikola Tesla. His love was already sealed. Tesla recovered from the flames.

His subsequent discoveries and inventions surpassed his former works for forty more years; special radiation projectors, self-acting heat engines, power transmitters, remote control and robotics, the "World Broadcast System", Beam Broadcast transmitters, "ætheric reactors and ætheric engines", cosmic ray motors, psychotronic television...the list of astounding inventions is truly awe-inspiring. Tesla demonstrated each of these systems for a select group of witnesses.

Furthermore, despite rumors of his public and scientific demise, Tesla maintained two penthouse suites atop the Hotel New Yorker in a time when such extravagance was otherwise unobtainable. One of these suites was converted into a complete radio laboratory, several accoutrements of which having been retrieved by antique radio enthusiasts. Tesla was an indefatigable researcher. The biography of Nikola Tesla is replete with truly mysterious designs and developments. But these are parts of his biography which must be told in other volumes. ■



The Pundit Curmudgeon

Pundit Curmudgeon v. Arthritis

© E.D. O'Brian 1996

HOPEFULLY the following chronicle of my problems with arthritis will be of benefit to some with open minds, even though this record is anecdotal to an extreme and is based upon an imperfect recollection of what actually occurred. While the occurrences discussed are not backed up by clinical double blind studies in the USA as desired by the FDA they are evidence of the type normally relied upon in making decisions. As such the facts stated may assist others and guide further investigations.

My first experience with arthritis commenced some 20 to 25 years ago when I played a game of chicken with my youngest son using bicycles and really lost. Our family physician at the time, a practical ex Iowa farm doctor type, listened to my story of what happened and how my shoulders felt and then pronounced that he thought an X-ray would be a waste of time since there was no doubt that I had arthritis in both of my shoulders. His instructions were simple - take aspirin and live with whatever pain it did not alleviate. With deference to the apparent infallible knowledge of the medical profession in the days before learning the imprudence of such beliefs I followed his instructions and, whenever reasonably acceptable, avoided lifting my arms because of the pain experienced during this type of motion.

A few years later I attended a seminar conducted by Dr. Valerie Hunt, a recently retired professor at UCLA, explaining much of her prior research. One of the speakers was a woman who specialized in what either she or others called "dance therapy". During her speech she had all of those in attendance stand by their seats in the amphitheater where the session was being held. We were then instructed to keep our eyes closed, to let our hands and arms fall loosely along our sides, and to "let your hands follow the music". Then she put on an LP record of a collection of non rhythmic, non structured yet "smooth", flowing sounds, which she alleged to be "music". It is best to skip the problem of whether or not it was in fact music.

After a short period I discovered that my hands and lower arms felt like moving upwardly. Feeling like a fool I let them. After they

had moved a short distance the old twinge set off in both shoulders. As my hands fell back to their initial positions I looked around the room. Others were waving their hands and arms in strange manners. Thinking that the whole procedure was stupid while concurrently recalling that I had paid good money to be at this seminar, I closed my eyes and again made an effort to follow the instructions. It didn't take long for my hands and arms to get a little higher than previously before the shoulder pain hit again. By this time many of the others present were gently moving their bodies and their hands into strange science fiction type positions. Once again I closed my eyes and repeated the prior steps.

This sequence was repeated about 4 or 5 times before the "music" stopped. Each time I closed my eyes and mentally released my hands and arms I ended up with the ability to move my arms higher than before without pain. By the end of the session my arms could be moved in a normal manner without setting off any alarm pangs. Unless you have had arthritis you probably cannot understand the personal significance of this. My changed physical condition was both unexpected and wonderful.

In fact it was so wonderful that I wanted to talk over what had happened during the discussion which followed. When the speaker finally responded to my request to speak I briefly indicated what had occurred and asked for an explanation of what had happened. In effect I was told to shut up and stop wasting the group's time since everyone knew that the type of micro movements performed by the body during this type of exercise frequently caused the breakdown of impediments to body movement.

I bought the record used when leaving the session as "insurance" in case the apparent cure was only temporary. Apparently it wasn't. As I recall the record - which I have succeed in "misplacing" - was called "Autumn Leaves". Unfortunately I have forgotten the name of the speaker, but I believe that she used a double or hyphenated last name one part of which was "Doud" or something similar and that she was using the service mark "Continuum" somewhere in the LA area.

This "cure" of my first session with arthritis still serves admirably but now seems to be losing a very minor bit of its effectiveness. Presumably this is a consequence of an incident last December. At the time I was in good health except for a tolerable old man's prostate and constipation. Both seem important to the total chronology. In any event, when the incident occurred the cargo ship I was traveling on took what must have been about a 40° roll in the middle of the night about a third of the way into a 15 day siege of a continuous storm. To avoid the aerial acrobatics involved in being thrown out of my bunk and across the room I seem to have executed in a sleepy manner an unclassified maneuver with my right leg

which tipped my weight so I plopped back in bed instead of onto the floor. Significant pain in the right hip joint accompanied the unscheduled gymnastics.

Since the elevator on the ship was a questionable mode of conveyance during a storm and since the dining room was 4 stories beneath my cabin I did not let the pain interfere with my daily walking. Probably as a result of a subconscious effort to facilitate the use of my legs, the hip and knee joints on both legs and the areas between these joints gradually became sore. Thinking that I had a pulled muscle, tendon or the like I kept going in as close to a normal manner as possible. According to my up bringing things like this are supposed to heal themselves in time.

But in this case it didn't. During the approximately two and a half months from the date of the unexpected gymnastics until I sought professional assistance, the pain in the lower back/hip area and in the region extending down to backs of my knees was damn intense. Also my prostate and bowels continued unhappily as before or with renewed undesirability. Otherwise I lived as normally as my problems in walking allowed. In addition I found that I was effectively unable to go into any hypnotic trance whereas normally I go into a rather deep trance without too much difficulty. There was a tendency to go to sleep or for the mind to drift off on almost any topic whenever an effort was made to enter a potentially healing trance. Pain seemed to have no role in connection with any effort to go into a trance.

While wishing for my body to cure itself I strongly believed that if I could obtain the help of several who attended a group which was called a "Healing Circle" that the pain in the region extending from the lower back through both of my knees would simply go away. This group held weekly meditation and healing sessions during which a person needing assistance was subjected to "energies" given off by the hands of one or more others. In effect the treatments corresponded to classic "laying on of hands" religious procedures and, to a greater extent, qi gong healing. Unfortunately I lacked the contacts to secure treatment which I would accept as desirable and reliable in the area where I reside.

Thinking that my problem was the type of thing best taken care of by a chiropractor I called on a long term friend who is in that field. After some feeling around she had me get an x-ray photograph of the painful area. Then, after further examination she indicated that she needed a series of x-rays of different areas in order to accurately diagnose my ailment. Since she knew that I belonged to an HMO she sent me off to the HMO with a list of the X-rays which she felt were needed for further treatment and instructions to have whoever I saw at the HMO call her if there was any question as to whether these were needed.

Due to the absence of my usual physician at the HMO I soon had a session with a physicians assistant (PA). It did not go well. When I gave him the note from the chiropractor while explaining why I was there he took the time to verify that the heading on it indicated that it confirmed its origin. I don't think he read further. As I continued to explain my current problem, he asked a few questions and then informed me that there was absolutely no indication that there was any need for any X-rays because there was no indication that I had broken any bones. As he said this he looked at the back of my right knee. To the best of my recollection he didn't even take the time to look at the area around my right hip where the whole problem

started. His sage advice was for me to take established painkillers and to indulge in some exercise therapy offered by the HMO. At no time while meeting with me did he consult with any other.

His statements provoked me into stating that I felt that I was being denied any significant treatment merely because I came to the appointment after consulting with a chiropractor. I asked if this was true. He did not reply. The same question with minor differences in wording was asked a total of about 3 to 5 times without my receiving an answer. Then I commented that his failure to verbally reply was in and of itself an admission that my suspicions were true. Again there was no reply. Much later I wondered if a desire to save the cost of the X-rays was a factor in my not getting them.

The chiropractor then ordered the series of X-rays which the HMO - through its agent the PA - said were unneeded. Later I saw in these photographs the formations clearly indicating that I had a form of arthritis. At this point my chiropractor friend did two things. One was to prepare a summary type letter going beyond the arthritis problem and calling attention to my having an apparently unrelated skin problem to my normal physician - not the PA- at the HMO setting forth what she had found. She also sent me home with copies of the materials she had in her files on the particular form of arthritis she believed I had (a form known as DISH) and the recommendation that I see my usual physician. As she did this I received comments regarding taking what the literature indicated to be the preferred pills for the problem, soaking in a hot tub and exercising.

More or less concurrently over a period of a few weeks I did everything she had indicated, started taking both aloe vera "squeezins" and glucosamine sulfate in addition to my usual collection of pills, and went in for the physical therapy the PA had authorized. On a sporadic basis starting toward the end of this period I would also place the red (south) poles of small Radio Shack ferrite, disc shaped magnets against various painful areas before retiring for the evening. These often went wandering in the bed clothes as the tape holding them in position failed to adequately function. Interestingly nothing I did at the time alleviated the constipation and I still found it virtually impossible to get into a hypnotic trance.

Also nothing significant in connection with the arthritis was noted until we got the cheapest, smallest hot tub in town installed and heated up. It was like an impossible dream. I cried as I quickly achieved a complete freedom of pain as the heat of this accidentally overheated tub went to work. After a few minutes I realized that unthinkingly I was moving in the water somewhat like a singer known as "Elvis the Pelvis" more or less in time to currently popular music from a small radio.

Unfortunately this relief did not last, but it enabled me to sleep without pain pills. The temperature of the tub was cut back from about 110F to a more conventional about 104 -105F out of concern for possible heart or high blood pressure complications. At such lower temperatures the hot tub still alleviated pain but was not as effective as when it was at about 110F. It seemed that the hot tub was most effective when I was listening to music, and in particular to music which my body wanted to react to. It also appeared to be highly desirable for me to sit quietly by the hot tub until my body seemed to return to normal after getting out of the hot tub.

As time passed it seemed to me that the "formal" exercises suggested by the HMO physical therapy weren't doing much, if any, good, although except for what increasingly appeared to be only

temporary relief from the hot tub the arthritis remained essentially unchanged. These exercises could have been having some benefit. At the final therapy session the woman who had outlined these exercises seemed to be trying desperately to get me to admit that I felt wonderful as a result of them. I couldn't. While at this time I usually felt slightly better than at the start of the exercises I still had significant pain, particularly at certain times and after certain activities. With the mess of folk and other treatments being used no one could tell what was and what was not "working".

Either shortly before or after this last physical therapy session I also made an appointment with my usual internist at the HMO. Prior to this meeting he and I had established a good working rapport. I had and still have respect for his competence within the scope of his training and experience, I like his personality and I expect to continue to use him as my primary physician. Perhaps this background is significant in connection with the appointment.

It appeared to me that he was reading the letter from the chiropractor for the first time as he came into the room to meet me. At the start of the session he made it clear that there is no cure for arthritis and that the conventional treatment involved pain pills and replacement of hip joints as needed. In our discussion I said I wanted a cure and not pain pills. He made it clear that I could easily get pain pills or hip joints I might require. In this discussion he did what I would have done and backed up the conduct of the PA.

The only aspect of our discussion which might be regarded as pertaining to the treatment of arthritis involved my asking about how hot I could keep my new hot tub with relative safety. He indicated that the primary "danger" from the use of a tub temperature of about 110F was that I might fall asleep and drown in a tub which was that hot. Apparently he had friends who kept their tub at this elevated temperature. We never did get into a discussion relative to the skin condition the chiropractor had mentioned in her letter to him.

When I asked at the appointment about the use of magnets in connection with arthritis he manifested puzzled disbelief. He had never heard of the topic. When I told him of work with magnets in connection with bone fractures some 29 or 25 years previously at a particular hospital he did a double take. Although having graduated from a medical school affiliated with that hospital he was completely unaware of any of the latter work. I dropped the topic. We parted amiably. I later sent him a reprint of the only article I could find in my files relative to the use of magnets by this particular hospital.

As a result of this session with the HMO internist it became apparent that the time had arrived to explore alternative remedies in earnest and to evaluate what these remedies had or had not accomplished. While many arthritics seem to live from pain pill to pain pill I was not going to live that way. My background in paranormal matters came in handy at this point.

The purchase of a roll of decent tape marked the end of my few sporadic efforts with magnets. I now diligently and with desperation motivated hope and again started taping the red poles of small Radio Shack disc shaped ferrite magnets to my posterior and/or to the backs of my knees before retiring. On occasion some magnets were also used on the back adjacent to the tail bone. The new tape held better than the old, but the damn things still frequently came off during the night. Those joints which had the benefit of this exposure to south seeking magnetic poles consistently seemed a slight bit better than those which did not.

It seemed like I could make the usual morning pain move from one hip to the other and from one leg to the other by the placement of the magnets when I retired for the evening. I tried the same thing using domino shaped ferrite magnets from the same source and appeared to obtain about the same or slightly less pronounced results. There was some indication that the larger magnets worked slightly better at the hips than the small discs and that the reverse was true at the backs of the knee joints.

After starting to seriously experiment with the use of magnets I had several significant discussions with a friend concerning this topic. It is important to note that he studies physiological measurements made with a machine by: setting the machine to a number believed on the basis of prior experience to correspond to a particular aspect of the operation of a person's body; placing either a part of the body or a representative or surrogate for the person on an electrode; and then using a so called "stick plate" in combination with a dial on the machine to determine a specific figure which is believed to indicate the performance of that specific aspect of the body. This figure can then be compared with similar readings obtained with other individuals. Similarly this figure can be compared with other results obtained by placing a symbol, an item such as a magnet or a composition on the electrode along with whatever else is placed on it.

During an early discussion relative to my use of magnets I discussed ways that I could get a representation of a pyramid, cone or other APEM attached where it might apply energy to clearly arthritic areas of my body. This was an outgrowth of an earlier article for *Borderlands* on the topic of APEMs. I also desired to attempt to use the "magic" associated with such a representation with magnets in such a manner as to avoid having to attach anything to my body.

This led to my friend taking pictures of my behind at two different distances both with and with out clothing. These pictures were used at bedtime only in conjunction with the red poles of the disc magnets placed over the areas portraying one or more of the following: hips, knees, and the tail bone. Only one picture was used at a time. The magnets were taken off of the photographs in the mornings after being in place all night.

It appeared to me that some limited but apparently temporary benefit was probably achieved in those parts of my body corresponding to where magnets had been placed. Perhaps some minor improvement in morning pain occurred when the photographs were of an unclothed rear end than when they showed an encased posterior. Similarly it seemed that the use of a close up photograph was slightly preferable to the use of one showing more than the apparently affected area.

These results could have been a consequence of wishful thinking. They were not graphic in character but they stimulated my thinking. At about this time I called Peter Lindemann to discuss a number of topics. As usual there was an interchange as to what had been happening and my thoughts as to what to try next. This led to my acquiring information as to his recommendations on stuff I should take to alleviate the arthritis and to his faxing me a print of a series of protective circles.

This led to my initially attempting to simulate a two dimensional representation of a cone. When my frustrations of trying to use a computer program got the best of me I accidentally produced a sheet with a series of 7 concentric circles which seemed to look good

when located within the protective circles supplied by Peter. Next I repeated all of the previously described activities with a composite assembly of a copy of a sheet containing both Peter's and my circles, the pictures as discussed and then one or more magnets in one or more locations corresponding to those when I had used magnets. The illustration to this column is a print of a sheet used containing both sets of circles (see page 61).

Clearly significant but not permanent benefits in morning pain reduction resulted from all of the uses of these assemblies. As nearly as I could tell these results were about the same as those achieved when magnets were used directly on my body and stayed in place during an evening. In other words it appeared that direct magnetic energy and magic were equally effective in my particular arthritic circumstance. Of course, other factors may have been responsible for the benefit achieved. I was clearly trying several expedients concurrently. Shortly before starting this column I learned that according to several books that I should have used the north instead of the south poles of the magnets.

Those interested in the topic of magic will find it interesting that after a sheet of circles as described was used a few times that the pain reduction noticed in the morning seemed to decline. As a result of recalling Stein's experience in having to re-ink a battery symbol after it had been used a while as set forth in his delightful book "Mind Machines You Can Build" I replaced a "used" copy machine print of the circles every day or two with a fresh one off of my copying machine. This seemed to result in alleviating the fall off in the results noticed.

These copy machine prints of the circles used had an interesting characteristic. After being used they would occasionally give off a magnetic field. On several occasions I obtained readings which could have been plotted as a more or less flattened bell shaped curve as an inexpensive gaussmeter was moved at a more or less uniform rate across any diameter of a used figure. The same results were observed by the friend noted in the preceding when we met in a fast food establishment. They have not been consistently obtained.

Probably the reason for the magnetic character of a composite figure which has been used with magnets relates to the fact that the particular toner used in my copy machine is magnetic. On the other hand it is more romantic to theorize there may be a deeper, more significant meaning relative to the ability of a APEM to be "charged" so as to act as an accumulator for a magnetic flux. It could also be that the composite responds to stray electric fields so as to act more or less like an antenna.

At or about the time that I started to give serious attention to the use of magnets it seemed to me that no significant benefit was being gained from the use of the aloe vera product and from the use of the glucosamine sulfate. Accordingly I replaced both in my morning rituals with vitamin B-12 and massive quantities of fruits and fruit juices. The latter largely consisted of cranberry juice. Also I made sure I choked down increasingly large quantities of water and iced tea. These dietary expedients were contemporaneous with the magnetic experimentation and much positive thinking.

As time progressed the arthritis seemed to improve significantly without disappearing. The pain associated with it seemed to both increase and decrease at random. There was no way of giving any specific course of conduct or combination credit for either the overall improvement or the variation in the pain. In many respects

my arthritis seemed to resemble a virus in the manner in which it occasionally seemed to manifest itself in one location and then after magnetic or heat application at that location seem to reappear at another area. I also noticed that the pain seemed to lessen on weekends when I could sleep longer than usual and when I could take naps whenever I got tired during the day.

Probably the most interesting aspect of this whole chronology surfaced at about the time I speculated as to the viral origin of my arthritis. My friend discussed this. At the time he had a "setting" for the machine described in the preceding, which was thought to correspond to viral activity in the body. The discussion on this viral origin lead to our trying the red pole of a small disc magnet as previously described on the L-I meridian point adjacent to my left thumb while my right hand was on the electrode of the machine and the machine was adjusted to this viral activity setting. The reading supposedly indicating activity at that setting immediately dropped from 47 "points" to 0.5 "points". When the magnet was removed the reading returned to its initial value with the same rapidity. In both cases the change was substantially instantaneous. Substantially the same results were achieved at an apparently reduced but still rapid rate with the other pole of the magnet.

This indicated that magnetic energy is carried in a human body along at least one acupuncture meridian at an extremely rapid rate. It also indicated that a viral infection may be halted for at least the period that magnetic energy is applied to such a meridian. If these early conclusions are verified my friend and I have made a potentially important discovery.

Presently it appears that the simple procedure of using the energy from a pole of a magnet on a selected acupuncture point may provide a manner of at least stalling any sort of a viral infection. Probably if the activity of a virus is stopped or nearly stopped in this manner for a long enough time period a virus within the body will not be able to rebound to an active state or may be killed as a result of the magnetic "treatment" of an acupuncture point.

In view of the current interest in dealing with viral infections this should be followed up ASAP. No genius is required to outline and accomplish the routineering necessary to determine which of the meridians are capable of carrying magnetic energy and which meridian points are "responsive" to such energy. It will be equally important to learn whether or not the energy used should be that of a north or south pole and the "strength" or intensity of the energy used whether or not it should be applied continuously or only at period intervals of presently unknown duration. Also will the treatment vary with different types of viral activity? All of such matters can be determined using routine experimentation.

There appear to be very definite limits on when the use of magnetic vitality will be of benefit in connection with at least the treatment of the type of arthritis I had or probably still have. This was in a way indicated by a friend loaning me a flexible plate of Japanese origin which was designed to be worn against the body so as to apply the forces or energies from a plurality of magnetic regions of alternating polarity to the body. Although apparently there are reports of this type of device being effective in the treatment of a number of ailments including arthritis all I am aware of gaining from the use of the device for a few days is a minor degree of discomfort and inconvenience.

The probable dangers of the use of excessive energy of magnetic

or other origin is suggested by another type of possible treatment of arthritis which was carried out during a short part of the period after I started serious efforts to deal with my arthritis. On the basis of my prior experience in the religious practice of applying energy through the hands for healing purposes I resolved to locate and use a so called qi gong machine which duplicated the energy given off by the hands of a traditional "healer". A machine of this type was obtained about the time I changed the dietary supplements I was taking.

Unfortunately after it had been used for about a week or so no improvement in the arthritis was noted. I speculated that probably this was because either the machine was used too often and or at too high a setting with the result that the affected parts of the body were in effect being bruised. The use of the qi gong machine was then stopped until quite recently. The current use of the machine has been so limited that no conclusions can be drawn from it other than nothing unfavorable has appeared in connection with it.

It increasingly seems that to at least a degree the use of a hot tub, particularly as non disturbing music of any type is played, the use of such music alone, particularly when the body is relatively free to move or "resonate" in response to the subtle energy of the music or the use any other sort of subtle energy at a frequency of about 7.83 cps or a multiple or even numbered fraction thereof probably is beneficial in connection with at least arthritis and undoubtedly other bodily malfunctions. Such effective energy is encountered in many sources such as the "dance" therapy previously described, a Silva Mind Control rhythm tape, an impinging jet of a hot tube or shower, a qi gong machine or traditional laying on of hands. All of such things are related and approximately equivalent.

It is possible that this is the result of my believing that my arthritis

was not bad enough late in April to force the cancellation of a vacation on a so-called "mail boat" in Norway. During this trip I relaxed and slept what seemed to an excessive amount both at night and during occasional day time naps. I also walked on shore during the frequent visits to various ports along the way at whatever pace which seemed at the time to be comfortable. And I ate fish in one form or another a minimum of twice a day and often three times per day.

This treatment — or, in any event, something — seemed to suit the arthritis and the bowels. The pain from the arthritis was materially less at the start of the trip than about the time I sought medical assistance. It was definitely present in a decreasing amount as the vacation continued. In particular I noticed it getting in and out of chairs and when standing for a comparatively long period but normally not at other times. When I returned home it appeared to have vanished. And, I also noted that my prostate no longer gave me any sort of a problem while the colon operated in what I regard as a normal manner. Also on the trip I found that I was able to enter a hypnotic trance for the first time since the onslaught of the arthritis. Apparently all of these problems are or were related.

As this is being written it is about one month after my returning home. I am aware that things are not overly flexible in the areas where the arthritis held forth and that on occasion there is a feeling in these areas corresponding to the feeling one gets after a mild excess of gardening or straightening up a mess in a garage. While it may not be true, I feel that I have substantially overcome at least the symptoms of arthritis. Others can do the same by means similar to those I have tried. ■

A DOOR HAS OPENED



Access mountains of significant information

Subscribe to
PERCEPTIONS
MAGAZINE

Issues:	1	6	12
U.S.	\$4.95	\$25.00	\$44.00
CANADA	\$5.95	\$33.00	\$59.00

U.S. FUNDS ONLY
Published bimonthly, distributed
in the United States and Canada.

c/o 10736 Jefferson Blvd., Suite 502-BR, Culver City, California, Postal Zone 90230
Main (310) 313-5185 • 1-800-276-4448 • Ad Sales (310) 313-5194 • Fax (310) 313-5198

Historical info to explain today's events

Essential data to restore sovereignty

Healing remedies and insights

Metaphysical overviews

UFO/Allen reports

Perceptions magazine contributes to personal and political empowerment while revealing pertinent information glossed over by mainstream media. Its full-spectrum approach to today's issues crosses the boundaries that separate cultures, ideologies and religions.

In-depth historical reports, important legislative analysis, thought-provoking concepts and UFO phenomena stand side-by-side in this sophisticated, yet easy-to-read publication.

Perceptions magazine awakens, challenges and tickles the intellect while touching the soul.

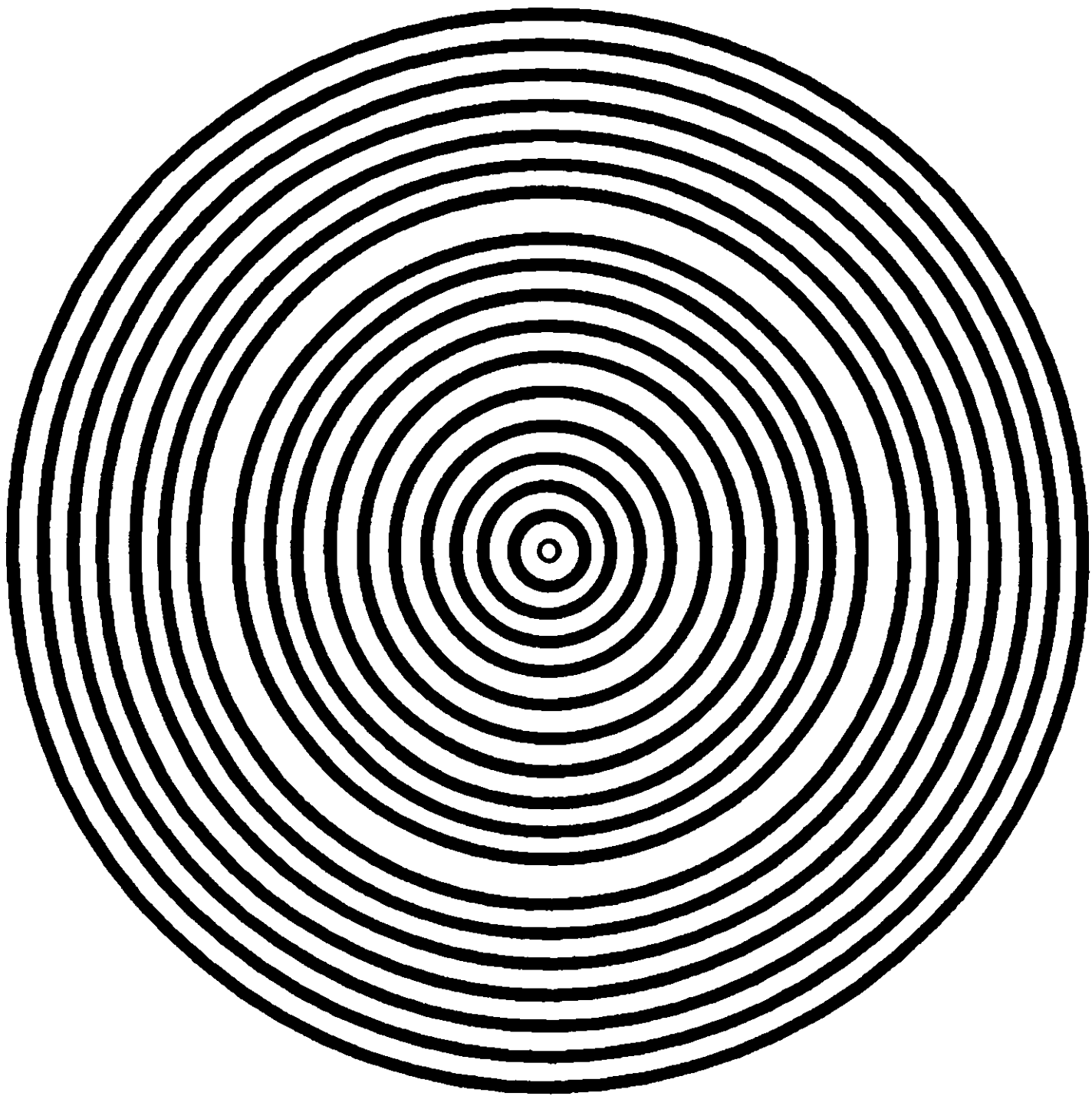

Did you miss BORDERLANDS something? SCIENCE

BORDERLANDS originated as Meade Layne's *Round Robin* in 1945 and was changed to *The Journal of Borderland Research* in 1959, finally becoming BORDERLANDS in 1992. BORDERLANDS backissues are available from 1990 to the present with very limited quantities of early original issues. Single issues are \$6.95.

☐ THE JOURNAL OF BORDERLAND RESEARCH

Vol. 46, Nos. 3 & 4, May-June-July-August 1990 (56 pp.)

- THE IRON ROD OF MARS - Alison Davidson
- HOMEOPATHY: A Vibrational Perspective - Dr. Donald R. Beans
- LIFE FORCES AND PHYSICS - Buryl Payne, Ph.D.
- EDGAR CAYCE & THE RADIAL ACTIVE APPLIANCE - Phil Thomas
- BIOCIRCUITS: New Technologies In Holistic Health - Terry Patten
- OZONE IS GOOD AND NATURAL - Ed McCabe
- RADIONIC MACHINERY TO REGULATE EARTH VEINICS - Gerry Vassilatos
- NOXIOUS EARTH ENERGIES - Kathe Bachler
- EFFECTS OF 6-10 Hz ELF ON BRAIN WAVES - David S. Walonick
- PHYSICS AND TECHNOLOGY OF THE PHENOMENON OF SPACE POWER GENERATION - Paramahansa Tewari

☐ THE JOURNAL OF BORDERLAND RESEARCH

Vol. 46, No. 5, Sept.-October 1990 (32 pp.)

- THERE IS NO "FREE" ENERGY - An Anonymus Friend
- MAGNETIC ENERGY TAUGHT ME BASIC NEW CONCEPTS - Larry Spring
- THE COIL/ORAC EFFECT - Nicholas A. Reiter
- VIKTOR SCHAUBERGER'S BIOLOGICAL SUBMARINE - Albert Zock
- UNDERSTANDING THE CONTINUOUS UNIVERSE, preparing for transmutation - Rhetta Jacobson Baumgartner
- AMERICA'S AMAZING ALCHEMIST - Vincent H. Gaddis
- QUICKSILVER - MERCURY'S LIQUID METAL - Alison Davidson
- OMENS, SIGNS AND THE ENERGIES OF TIME - Eugenia Macer-Story
- CONDUCTING CHLOROPHYLL ENERGY OVER WIRES - Dr. T. Galen Hieronymus.

☐ THE JOURNAL OF BORDERLAND RESEARCH

Vol. 46, No. 6, Nov.-December 1990 (32 pp.)

- JUPITER AND TIN - Alison Davidson
- JACK DERBY - MR. FIX-IT/NEW AGE INVENTOR - Harry Davis
- APPARATUS FOR DETECTING EMANATIONS FROM PLANETS - Buryl Payne
- MAGNETIC ENERGY TAUGHT ME NEW BASIC CONCEPTS, Part II - Larry Spring
- PHANTOM ARMIES OUT OF TIME - Vincent H. Gaddis

☐ THE JOURNAL OF BORDERLAND RESEARCH

Vol. 47, No. 3, March-April 1991 (32 pp.)

- OPERATION CLINCHER - A B.R.S.F. Special Report
- SACRAMENTAL THINKING - Joel A. Wendt
- URANUS AND THE RADIOACTIVE METALS - Alison Davidson
- THE WORLD RUNS ON AC - Larry Spring
- THE SPIRAL COIL MWO, Part II - Louis A. Schad

☐ THE JOURNAL OF BORDERLAND RESEARCH

Vol. 48, No. 3, May-June 1992 (32 pp.)

- BORDERLAND QUAKES! - Michael Theroux
- ON THE TRAIL OF THE LAKHOVSKY M.W.O. - Jorge Resnes
- VIEW FROM THE BORDERLANDS: Some MWO/RCO Questions Answered - Tom Brown
- M.W.O. ROUNDUP - Peter A. Lindemann
- EXISTENCE OF ABSOLUTE TIME - Dorotheos C.E. Cody
- FIZIX CORNER - Peter A. Lindemann
- A ROUND PEG IN A SQUARE HOLE - Larry Spring
- FIELD GENERATORS - R.F. Directo
- SCIENCE FICTION REVIEWED - Michael Theroux

☐ THE JOURNAL OF BORDERLAND RESEARCH

Vol. 48, No. 5, Sept.-October 1992 (32 pp.)

- TUNNELS OF THE TITANS - Vincent Gaddis
- PRE-COLOMBIAN GEODESICS - Jorge Resnes
- ANCIENT COSMOGRAPHY AND THE CROP CIRCLES - Michael Theroux
- THE CIRCLEMAKERS - Book Review
- MUSIC, ALCHEMY, AND PROJECTIVE GEOMETRY - Michael Theroux
- DESIGN ECOLOGY - Michael Riversong
- FIZIX KORNER - Peter Lindemann
- AIDS/SYPHILIS UPDATE - Peter Lindemann with Joan McKenna
- THE UNION ESPIRITISTA CHRISTIANA DE FILIPINAS - Harvey Martin

☐ THE JOURNAL OF BORDERLAND RESEARCH

Vol. 48, No. 6, Nov.-December 1992 (32 pp.)

- CHACO CANYON - Great Wonder of the World - Alison Davidson & Tom Brown
- RECORDING TELLURIC SIGNALS, Part I - Gerry Vassilatos
- ASTRONOMICAL CORRELATIONS FOUND IN CROP FORMATIONS - Colette M. Dowell, N.D.
- FIZIX KORNER - Peter Lindemann

☐ BORDERLANDS - *The Crossroads of Science and Spirit*

Vol. 49, No. 1, 1st Quarter 1993 (52 pp.)

- THAT WHICH IS ETERNAL IN US MUST BE AWAKENED - Tom Brown
- DEVELOPING THE KOLISKO APPROACH - Nick Kollerstrom
- I AM ENERGY - Larry Spring
- A POSSIBLE ALTERNATIVE TO BATTERY POWERED VEHICLES - Ed O'Brian
- DESIGN ECOLOGY, Part II - Michael Riversong
- RECORDING TELLURIC SIGNALS, Part II - Gerry Vassilatos
- THE PAPER DOCTOR - Book Review by Peter A. Lindemann

☐ **BORDERLANDS - The Crossroads of Science and Spirit**

Vol. 49, No. 2, 2nd Quarter 1993 (52 pp.)

- * THE MYSTERY OF QIGONG - Dr. G.K. Knowlton
- * CHAOS, ORDER OR NATURE? - Michael Theroux
- * SCHAUBERGER VS. ARCHIMEDES - Albert Zock
- * INTERACTION OF MAGNETIC FIELD AND POWER CURRENT IN SPACE, POWER GENERATION - Paramahansa Tewari
- * FIZIX KORNER - Peter A. Lindemann
- * ELECTRO-THERAPEUTIC APPLIANCE - U.S. Patent 412,196, John S. Mellon
- * Paradigm de Jour GREY ALIENS BITE THE DUST - Alison Davidson
- * DESIGN ECOLOGY, Part III - Michael Riversong
- * SCIENCE & HEALTH and THE EARTH & OURSELVES: Books by Georges Lakhovsky - Reviewed by Jorge Resines
- * ANOTHER POSSIBLE ALTERNATIVE TO BATTERY POWERED VEHICLES - Ed O'Brian
- * EXPLORATIONS IN GRAND CANYON: Mysteries of Immense Rich Cavern Being Brought to Light - "Phoenix Gazette", April 5, 1909

☐ **BORDERLANDS - The Crossroads of Science and Spirit**

Vol. 50, No. 2, 2nd Quarter 1994 (52 pp.) *Riley Hansard Crabb Memorial Issue*

- * SHED NO TEARS FOR RILEY - Trevor James Constable
- * FLYING SAUCERS AND AMERICA'S DESTINY - Riley Crabb
- * THE MEANING OF THE WORD PSYCOGRAPH - E. D. O'Brian
- * DECIPHERING THE MOST MYSTERIOUS MANUSCRIPT IN THE WORLD - Michal Theroux
- * EIDETIC GEOCENTRISM - Part I - Gerry Vassilatos

☐ **BORDERLANDS - The Crossroads of Science and Spirit**

Vol. 50, No. 3, 3rd Quarter 1994 (52 pp.)

- * TZOLKIN - John Major Jenkins
- * THERMODYNAMICS AND FREE ENERGY - Peter Lindemann
- * COMMUNICATION AND THE EIDO-DENDRITIC EXPERIENCE - Michael Theroux
- * INDUCING THE URPFANZE - Dennis Klocek
- * EIDETIC GEOCENTRISM - Part II - Gerry Vassilatos
- * EARTH'S CENTER OF GRAVITY - UP OR DOWN - Ray Palmer

☐ **BORDERLANDS - The Crossroads of Science and Spirit**

Vol. 50, No. 4, 4th Quarter 1994 (52 pp.)

- * THE FIFTH SUN - Aymon de Roussy de Sales
- * SEISMOLOGY IN BRIHAT SAMHITA - Dr. E. A. V. Prasad
- * THE ETHER-WORLD OF THE PLANETARY SPHERES - Dr. Guenther Wachsmuth
- * EIDETIC GEOCENTRISM - Part III - Gerry Vassilatos
- * KONG JING - EMPTY FORCE - Dr. G. K. Knowlton
- * FOLLOW THE SUN - Larry Spring

☐ **BORDERLANDS**

The Quarterly Journal of Borderland Research

Vol.51, No.1, 1st Quarter 1995

- * UNKNOWN ITALY - Jorge Resines
- * THE MARS REDHEAD LINK II - MARS DISTRIBUTION PATTERNS IN REDHEAD POPULATIONS - Judith A. Hill
- * SCORPIONIC AMERICA - David Solte
- * THE NATURE OF THE ETHERIC WORLDS - N. Meade Layne
- * THE ALCHEMY OF CAPACITANCE - Dennis Klocek
- * EIDETIC SPACE - THE GROUND OF BEING - Gerry Vassilatos
- * ON THE DISSIPATION OF THE ELECTRICAL ENERGY OF THE HERTZ RESONATOR - Nikola Tesla
- * FIZIX KORNER - Peter Lindemann

☐ **BORDERLANDS**

The Quarterly Journal of Borderland Research

Vol.51, No.2, 2nd Quarter 1995

- * THE FARNSWORTH FUSOR: THE MOST NOTABLY FORGOTTEN EPISODE IN "HOT" FUSION HISTORY - Gerry Vassilatos
- * BARCODES: "MARK OF THE BEAST" - Peter Lindemann wiath Ajna Luminaria
- * THE MARS-REDHEAD LINK II - MARS DISTRIBUTION PATTERNS IN REDHEAD POPULATIONS, PART II - Judith A. Hill
- * UFO MIND GAMES - Eugenia Macer-Story
- * REVERSING THE AGING PROCESS - Dr. G.K. Knowlton
- * ON PROPHETS AND PROPHECIES - Jorge Resines
- * THE GEOLOGICAL COLUMN - Thomas J. Brown

☐ **BORDERLANDS**

The Quarterly Journal of Borderland Research

Vol.51, No.3, 3rd Quarter 1995

- * TESLA'S "SELF-ACTING" ENGINE - Peter Lindemann
- * EARTH ENERGY AND VOCAL RADIO: NATHAN STUBBLEFIELD - Gerry Vassilatos
- * MYSTERY STONE OF NEW MEXICO - William Peavy, Ph.D.
- * EARTHQUAKES AND ASTRLOLOGY: THE REGIONAL FACTOR IN PLANETARY SEISMIC CORRELATION - Judith Hill
- * THE REDISCOVERY OF VRIL: AN INTERVIEW WITH GERRY VASSILATOS - Conducted by Michael Theroux
- * AQUALITHIA REVISITED - Haroldine
- * IMPROVING SEX THROUGH QI GONG - Dr. G.K. Knowlton

Not all backissue titles are listed here.

Most titles back to 1990 are available.

Please contact Borderlands for a complete listing.

All titles subject to availability.

Order any 10 issues and receive 25% off!

All prices subject to change without notice.

To order call (707) 825-7733 or write:

Borderland Sciences Research Foundation

P.O. Box 220 ★ Bayside ★ California ★ 95524 U.S.A.

<http://www.borderlands.com>



Borderland Sciences T-Shirts

Although not necessarily a research tool, this shirt will certainly make you stand out among the rest of the crowd. Show everyone you're a Borderlander by wearing the greatest T-shirt on the planet! T-shirts are white, emblazoned with the Borderlands logo in black. All shirts are 100% pre-shrunk cotton, and are available in sizes small, medium, large, and extra-large. Please specify size when ordering.

Borderland Sciences T-Shirts, #E0010 ... \$15.00

The Q-Ray™ Bracelet

The Q-Ray™ Bracelet is designed to achieve many of the same objectives as traditional Chinese acupuncture. Acupuncture was developed to balance the body's Yin (negative ions) and the Yang (positive ions), the inseparable, complimentary energies that permanently circulate in the human body. When these energies become unbalanced, the body's functioning is thought to be altered, which can at the least be very annoying and at the worst debilitating, depending on the size and nature of the energy imbalance. Oriental medicine, through acupuncture, is believed to regulate these two energies, discharging from the body the excess positive ions or static electricity and providing access to blocked negative ions. Since its creation in 1973, many people worldwide have claimed benefits from using the Q-Ray™ Bracelet. Please specify wrist size when ordering (Small — 6-7 inches; Medium — 7-7¼ inches; Large — Over 7¼ inches).

The Q-Ray™ Bracelet, #E0034 ... \$49.95

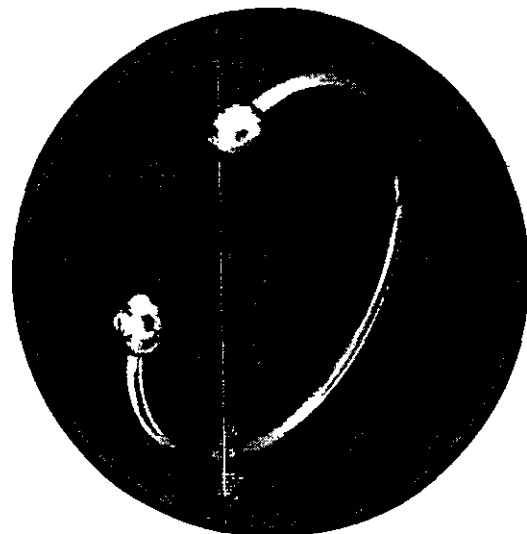

P.O. Box 220 ★ Bayside ★ California ★ U.S.A.
Postal Zone 95524

ADDRESS CORRECTION REQUESTED

BULK RATE
USA POSTAGE
PAID
Providence,
Rhode Island
Permit No. 2475