

JANUARY

\$1

Whole Earth Catalog

The \$1 Catalog was formerly called the SUPPLEMENT to the Whole Earth Catalog. The name was changed to accommodate the Post Office. Grim details on p. 53.



CBS Radio

THE OUTLAW AREA

From Arthur Godfrey to *Esquire*

IN RESPONSE TO YOUR KIND INVITATION OF JULY 9TH, IT STRIKES ME THAT THE CHALLENGES FACING ALL OF MANKIND ON THIS PLANET IN THE SEVENTIES HAVE NOW RESOLVED THEMSELVES INTO A VERY SIMPLE ONE: SURVIVAL.

INCREDIBLE AS IT MAY SEEM, MAN NOW FINDS HIMSELF ACTUALLY LISTED AS ONE OF THE ENDANGERED SPECIES, NOT IN THE NEXT THOUSAND YEARS OR EVEN THE NEXT HUNDRED—BUT WITHIN THE NEXT THIRTY YEARS—ALL THAT'S LEFT OF THE TWENTIETH CENTURY.

continued on page 20

FUNCTION

The WHOLE EARTH CATALOG functions as an evaluation and access device. With it, the user should know better what is worth getting and where and how to do the getting.

An item is listed in the CATALOG if it is deemed:

- 1) *Useful as a tool,*
- 2) *Relevant to independent education,*
- 3) *High quality or low cost,*
- 4) *Easily available by mail.*

CATALOG listings are continually revised according to the experience and suggestions of CATALOG users and staff.

PURPOSE

We are as gods and might as well get good at it. So far remotely done power and glory—as via government, big business, formal education, church—has succeeded to the point where gross defects obscure actual gains. In response to this dilemma and to these gains a realm of intimate, personal power is developing—power of the individual to conduct his own education, find his own inspiration, shape his own environment, and share his adventure with whoever is interested. Tools that aid this process are sought and promoted by the WHOLE EARTH CATALOG.

SUSTAINING SUBSCRIBERS

Julia Brand
Forrest A. Richey, Jr.
Frederick W. Davis

Rockford, Illinois
Charleston, West Virginia
Kirkland, Washington

RETAINING SUBSCRIBERS

Mark Albert
John Doss
Edmund Scientific Co.
Henry Jacobs and Assoc.
Edward Rosenfeld
St. George Bryan
Geoffrey Gates
Peter Cornell
Bill Davis
Halbert Speer
Constance Hwang
Terry Borton
Frederic and Karen Worden
Don Winsberg
Jeffrey Mitchell

San Francisco, California
San Francisco, California
Barrington, New Jersey
Sausalito, California
New York, New York
Maui, Hawaii
New York, New York
Berkeley, California
Boulder, Colorado
Sea Cliff, New York
Berkeley, California
Cambridge, Massachusetts
Sausalito, California
Chicago, Illinois
New York, New York

The Committee
Mrs. Audrey Sabol
Paul Kventsky
Syntex Corporation
Geoff Stirling
Bernard Loven
Ronald Jorgensen
Gerald J. Driessen
Joseph L. Bridger
Joe & Ann McConnell, Jr.
Vera L. Pratt
Jim Temple
Anthony D'Amato
Bill Chaitkin
David M. Meggyesy
James J. Storrow III
Eugene Lee
Martin Stephen Moskof
& Associates, Inc.
Mr. & Mrs. Warren Rubin
Edward Rosen
Mrs. John Hauberg
David Baxter
Hendrik D. Gideonse

San Francisco, California
Villanova, Pennsylvania
Houston, Texas
Palo Alto, California
Wickenburg, Arizona
Minneapolis, Minnesota
New York, New York
Chicago, Illinois
Woodstock, New York
Point Reyes Station, California
Cambridge, Massachusetts
Adamant, Vermont
Chicago, Illinois
Syracuse, New York
Saint Louis, Missouri
New York, New York
Warwick, Rhode Island
New York, New York
New York, New York
Seattle, Washington
Beverly Hills, California
Washington, D. C.

Mr. & Mrs. Louis Mackall
Michael Dreyfuss
Barbara Schultz
Mrs. Nicholas DeWolf
Jack Wise
Mr. & Mrs. David Menkin
Mr. & Mrs. Fred Lazarus III
Mrs. Martin Dimbat
Mrs. Charlotte L. Taylor
D. T. Carter
Monroe Litman
Bob Mitchell
Camiel Productions Inc.
Nancy Dibner
Phil & Naomi Schechter
Philip Ebersole
Susan Christian
J. R. Getsinger
Donald R. Marsch
David & Rosalyn Lounsbury
The Gray Family
Jim & Bitte Miller
Bob & Mary Esther Woodbury
Warren Besore

Milford, Connecticut
Trumansburg, New York
Chicago, Illinois
Boston, Massachusetts
Texada Island, British Columbia
Los Angeles, California
Cincinnati, Ohio
Concord, California
Rochester, New York
USS Grant County, FPO, New York
New York, New York
North Bergen, New Jersey
Brooklyn, New York
Westbrook, Maryland
Longport, New Jersey
Hagerstown, Maryland
Poxbury, Massachusetts
Bethesda, Maryland
Chicago Heights, Illinois
Carbondale, Illinois
Portland, Oregon
Geyersville, California
Davis, California
Washington, D. C.

CONTENTS

Corrections

FALL 69 CATALOG 5

- | | |
|---|--|
| 5 Concepts of Ecology
Cosmic View
Structural Integration
Lama/Cookbook Poster
On Growth and Form
The King and the Corpse
The Futurist
The Indian Tipi
Oceanography in Print
Clyde Robin's Seeds
Ferro Cement
Solar Stills
Dye Plants and Dyeing
Buckskin
New Science of Strong Materials
Diagrams
Supply and Demand | 6 Colour Guitar
Corona Grain Mill
Erewhon Trading Company
The Impoverished Students' Book of
Cookery, Drinkery, & Housekeeping
Massage: Principles and Techniques
Dear Dr. Hippocrates
Happy Baby Food Grinder
Baby and Child Care
I Know a Place
Thinking Straighter
The English Duden
Self-Hypnosis
Using Libraries Effectively
American Boys Handy Book
Fieldbook for Boys and Men
We Built Our Own Computers
or WHOLE EARTH CATALOG |
|---|--|

Item Related Information 7

- | | |
|--|--|
| 7 Galaxy Price Change
Ida Rolf
VITA in USA
Plastics
Handbook of Chemistry & Physics
Dyes
Graphic Terminal
Grain | 8 Food
Modern Utopian
Federal Assistance
Lightweight Camping Equipment
Gerry
Book of Survival
BMW
Film Guides
New Schools Exchange
Dulcimers
Commune Finding |
|--|--|

New Suggestions 9

- | | | | | | | |
|---|---|--|---|--|--|--|
| 9 Construction
The Future of the Future
Vivid Fatherhood
Bikes
Shower Shoes
Notice All Personnel
Roger Knights Suggests
How About an America Cup
Wheelchair Race? | 14 Kelly Yeaton Suggests
Bulk Film
Boat
Little Car
Architects and Hot Water
What's a Tesla Motor
Non-skid moccasin
Library-College | 15 Make a Boat
Outdoor stuff
Ranch duds
Scuba supplies
Water purifier
Neoprene snowshoe binding
Ballooning | 16 Seafaring Sauna
The Johnson Smith Catalog
The Forest People
Alternate Society | 17 Kids' books
Sesame Street
Move. Speak.
Community Market
Radical Films
Learning Gear
Black Reading List
Larry Robin suggests
Navigational Electronic Boy Scout | 18 Replace cars before they replace us | 19 Composting
Garbage As You Like It, and
Compost Science
Cycle Parts & tools
Filmmaking
Soleri's book at last
Mother Earth News
Indian Uses of Native Plants
Peoples Medical Handbook |
|---|---|--|---|--|--|--|
- | | | | |
|--|--|--|---|
| 10 Small Business Administration
Savings checks?
Solar Prints
Shaw suggests
Biodegradable
Service access
Eekological
Does Kinnikinick Cause
Lung Cancer
Philadelphia
Science, ax, projector
Old Car Parts
Low-cost drugs | 11 Anonymous suggests
Book discounts
Magazine subscription discounts
Cooking High
A Better Volkswagen Book
Mysticism
Square Dollar | 12 Randy Chakerian suggests
Knife
From Earth's First Groupie
Cultural Stuff
Clear Pictures
Esalen Tapes
Foodarama plus | 13 New Fuller Book
Hong Kong 1
Hong Kong 2
Farmless Harvest
Food Preserving
Cosmofoodarama |
|--|--|--|---|

Outlaw Area 20

- | | |
|---|---|
| 20 From Arthur Godfrey
to <i>Esquire</i>
Ecology trip
The Crisis of Crises | 21 Apocalypse juggernaut hello
Loose Talk 1: THE OUTLAW AREA
Loose Talk 2: DOPE ACADEMY
Loose Talk 3: MOUNTAIN FANTASY |
|---|---|

Liferaft Earth 23

- | | |
|----------------------------------|---|
| 23 Game Design
Liferaft Earth | 27 Population bibliography
Abortion
Sterilization |
|----------------------------------|---|

Earth Peoples Park 28

- | | |
|--|--------------|
| 28 Free some land, and not just a little
Voices at the Park meeting | The Document |
|--|--------------|

Ecology 30

- | | |
|---|---|
| 30 Know Your Local Polluters
Good Housekeeping
Some Questions
Four Changes | Ecological deeds
Report from Boston
The Tassajara Ecological
Thoroughness Prize
The Environment Monthly |
| 31 Annotated Bibliography | |

Death, Old Friend 34

- | | |
|---|--|
| 34 To Gary Snyder
From Gary Snyder
To Lenny Bruce | Bequeathal of Bodies of Young People for
Radiation Research
The death of Osceola, the Seminole
January 30, 1838 |
|---|--|

Process 35

- | | | | |
|---|---|--|--|
| 35 HOME METHANE GENERATOR
Bum trip conversion—a query
From Manny Meyer
Polar Operations
EDUCATION | 36 WHOLE CONSCIOUSNESS CATALOG
Baba Ram Dass' booklist | 37 Computerdom is hard to enter. Why?
EDUCATION
Texts
Liquid Wrench | 38 Trail crotchets
How to Start a High School
Underground Paper
Ferro-cement
Communal Bath
Breakfast
Bread
Purchase of Whole Grain
Products and Beans
Survival book, Jr.
Hydroponics (Aquiculture)
Dome math
Vegetarians disregard |
|---|---|--|--|

Canada 40

- | | |
|---|-----------------------------|
| 40 Island Fantasy, in depth | |
| 41 Agricultural Info
Canadian Tax Land for Sale
Land Info on Alaska | Crown lands
Climate info |

Other People's Mail 42

- | | | | | | |
|---|---|--|---|--|---|
| 42 From almost-editor of
Nomadics section
What is responsibility?
From Moe Armstrong
Sorry
Evolution | 43 Sell Snuglis
Alternative child styles
Congratulations
Hot Scandal
Be Gentle
From Vietnam to S. F. Chronicle | 44 Why people here fight over
who gets to open the mail
How to Dig a Dome
Canal Boats
Yikes
For warmer baby-having
From Steve Baer
Name your poison
Stock Answer No. 1, in depth | 45 From Zen Mountain Center
to Anonymous
Farmers of 40 Centuries
Customer Controlled Quality—
a true story
From Drop City to Anonymous
From Tom Duckworth
Brazil
Peace Corps let down | 46 From Stanley Marsh 3 to Steve Baer 1
Fleshfeather wants to know
From Sally Campbell to Lai Ching,
whose address we lost
In Memoriam
Responsibility of Perfection
From John Holt
Fish protein
How to have a secure, rusty ax
What if we run out of plastic ore? | 47 The sour stomach of success
Air structure contractors
Brown rice again?
Aircraft inspection
Pure land & ecology kits |
|---|---|--|---|--|---|

Gripe Page 47 Extra 48

- | | | | | |
|---|--|--|-------------------------|--|
| 48 Another change: Observers Handbook
Another change: Green Revolution
Earth Flag
From brain to eye
Food from Waste
The space out
Kill-or-Cure Method for cleaning gooked-
up typewriters:
Cyclops
Computer image
Skintight | 49 Notice
Haste made waste
Curta Calculator
Tools at University of Illinois
Important change: Birth Control Handbook | 50 We are Stranded On
an Island in Space
Short-Lived Phenomena
World Game | 51 Technical supplement | 52 Peradam
Tips on Galvanized Roofing
Battle of the Giants
Hangover-ade |
|---|--|--|-------------------------|--|

Business 53

- | | |
|---|---|
| 53 The great mail hassle
The great Fall CATALOG mailing breakdown
Will the CATALOG sell out?
Production Costs
Suggestion Form | 54 Truck Store
Catalog Distribution
Subscription Form |
|---|---|

CATALOG Procedure



Ordering from the CATALOG

Address orders to the supplier given with the item (unless you know of a better one; if you do, let us know).

If the price listed is not "postpaid", consult post office or express agency for cost of shipping from supplier's location to yours.

Add state sales tax if transaction is within your state. (California sales tax is 5%.)

Send check or money order with your order.

Blank order envelopes are provided at the back of the CATALOG for your convenience and so that suppliers have some idea of the CATALOG's effect on their business.

If the supplier gives you poor service, let us know. That information can be added to his review.

With some indicated items the CATALOG also will ship. There is no price difference with the service; the CATALOG gets the markup instead of the other guy, is all. Our service is fairly fast, especially for west coast orders. Bear in mind there's an inflation on. Prices are subject to rise without notice.

Generally, the closer the supplier is to you, the quicker and cheaper the shipping will be. If the item you're getting is delicate or if you are in a hurry, air express is a good deal. Anything overseas do by air, unless you want to wait a month or so for delivery.

Subscribing to the CATALOG

\$8.00 per year. This includes six issues, two big ones (Fall and Spring) and four smaller ones. Subscription forms are at the back. Memorize your zip code. If your address changes, you must tell us, because the Post Office won't forward.

Suggesting and Reviewing

The validity of the information in the CATALOG is only as good as the transmitted experience of users. What would you add to the current CATALOG?

The CATALOG pays its reviewers \$10 an item for: getting familiar with the item, its usefulness, and its competition; evaluating the item; selecting samples of graphics or text (with page references) for the review; writing a 100-300 word review. Reviewers and first-suggestors of items are credited in the CATALOG.

We invite reviews that improve on present reviews or accompany suggestions for new items. On acceptance for CATALOG publication reviewers are paid \$10 per accepted review. Unused reviews are not returned. Appearance of submitted material doesn't matter unless it is meant to be camera-ready.

Corresponding

Commentary from CATALOG users that is of general interest is published in the \$1 Catalog. Critical comments, new design processes, no-cash techniques, news of specific enterprises, useful fantasies, design student work, time and trouble shortcuts, new uses for common or exotic materials, other realms for the CATALOG to consider, &c., &c., — welcome.

Donating

Portola Institute, Inc. is a tax-exempt, non-profit educational corporation. Donations to Portola or the CATALOG may be deducted. Retaining subscriptions to the CATALOG are \$25 for one year (\$17 tax deductible). Sustaining subscriptions are \$100+ per year (\$92+ tax deductible). Names of retaining and sustaining subscribers are given in the CATALOG.

Gifts and Informal Resale

CATALOGs are available in quantities of 5 or more at 25% discount. Thus you can get 5 CATALOGs for \$15, sell four, keep one, and come out \$1 ahead. There is no quantity discount on subscriptions.

For formal resale, see p. 54.

Advertising

Suppliers, manufacturers, creators of listed items are eligible to advertise in the Fall and Spring CATALOGs. They may advertise only an item listed or their own catalog. All ads are placed at the back of the book. There are no ads in the \$1 Catalog.

Advertising rates:

full page \$200	\$75	full page 10 1/2" x 14 1/2"
	\$25	1/2 page 10 1/2" x 7"
	\$10	1/4 page 5 1/2" x 7"
	\$5	1/8 page 5 1/2" x 3 3/8"
		1/16 page 2 1/2" x 3 3/8"

CATALOG Policy with Suppliers and Users

The CATALOG is under no obligation to suppliers. Users are under no obligation to the CATALOG.

Suppliers (manufacturers, creators, etc.) may not buy their way into the CATALOG. Free samples, etc. are cheerfully accepted by CATALOG researchers; response not predictable. No payment for listing is asked or accepted. We owe accurate information exchange to suppliers, but not favors.

Our obligation is to CATALOG users and to ourselves to be good tools for one another.

This issue of the \$1 Catalog takes place on the far edge of a volume change around here. More customers and subscribers, more information coming in, more fame (Time, Playboy, Vogue, ye gods), more staff, more bookkeeping. "Any quantitative change by a factor of ten," says Doug Engelbart, "is a qualitative change." Or, You Pays Your Money and Your Choice Takes You. This issue was put together by:

Stewart Brand	Lois Brand	Jerry Finn
Cappy McClure	Tracy McCallum	Barbara McCallum
Hal Hershey	John Clark	Leslie Acoca
Mary McCabe	Russell Bass	Bernie Sproch
Fred Richardson	Les Rosen	Megan Raymond
	Peter Ratner	Pam Smith
with (store)	Laura Besserman	Rob Gilmer
Diana Shugart	Alan Burton	

and too many contributors to list any more. They're credited by their items.

Preparation of the CATALOG was done on an IBM Selectric Composer, Polaroid MP-3 camera, and Stat-King camera. Printing by Nowels Publications, Menlo Park.

The WHOLE EARTH CATALOG is published at Portola Institute, 558 Santa Cruz, Menlo Park, California 94025 on the following schedule:

Fall CATALOG — November	Spring CATALOG — May
\$1 Catalog — January	\$1 Catalog — July
\$1 Catalog — March	\$1 Catalog — September

Fall 69 CATALOG Corrections



p.5

Concepts of Ecology
Was \$2.95; is now **\$3.95**
postpaid

from:
Prentice-Hall
Englewood Cliffs, N. J. 07632
or WHOLE EARTH CATALOG

p.16

The King and the Corpse
From \$1.75 to **\$5.00** postpaid
hardbound

from:
Princeton University Press
Princeton, N. J. 08540
or WHOLE EARTH CATALOG

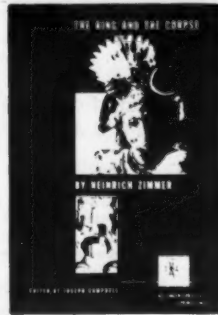

p.39



Solar Stills
We left out their address:
Sunwater Company
10404 San Diego Mission Road
San Diego, CA 92120

RESIDENTIAL TYPES
Bulletin 68-3

p.6

Cosmic View \$4.50 postpaid

New access information:

The John Day Company, Inc.
257 Park Avenue South
New York, N. Y. 10010

or WHOLE EARTH CATALOG



p.13

The Futurist
Used to be \$5.00.
Now
\$7.50 for one year
postpaid

from:
World Future Society
P. O. Box 19285
20th Street Station
Washington, D. C.

p.54

Dye Plants and Dyeing
DOWN from \$2.50 to **\$1.25!**
postpaid

from:
Brooklyn Botanic Garden
1000 Washington Avenue
Brooklyn, New York 11225

or WHOLE EARTH CATALOG



p.56

Buckskin

Their address should read:

Leather Tanning Company
P. O. Box 24068
San Francisco, CA 94124

p.57

New Science of Strong Materials
Now available in paperback for **\$1.35**
postpaid

from:
Shambala Booksellers
2482 Telegraph Avenue
Berkeley, CA 94704

or WHOLE EARTH CATALOG



p.8

Structural Integration

\$1.00 postpaid

from:
Guide for Structural Integration
1822 Fell Street No. 5
San Francisco, CA 94117



p.27

The Indian Tipi
Was \$4.95; now **\$6.95**
postpaid

from:
University of Oklahoma Press
Sales Office
Faculty Exchange
Norman, Okla. 73069

or WHOLE EARTH CATALOG

p.10

Lama/Cookbook Poster
Corrected price: **25¢**
postpaid

from:
Lama/Cookbook Fund
Box 422
Corrales, N. M. 87048



p.30

Oceanography in Print
It's not free, but it's cheap: **75¢** postpaid

from:
Sailing Book Service
34 Oak Avenue
Tuckahoe, N. Y. 10707

p.59

Diagrams

Blackwell's has this more cheaply: **\$10.56**
postpaid by surface mail from England.

Blackwell's
Broad Street
Oxford, ENGLAND

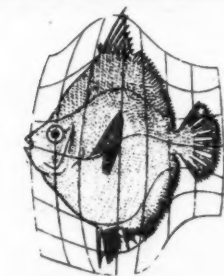
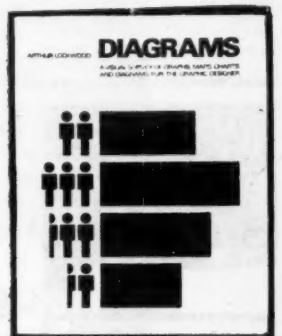

p.32

Clyde Robin's Seeds
Catalog was \$.25; is now **50¢**
postpaid

from:
Clyde Robin
P. O. Box 2091
Castro Valley, CA 94546



p.11

On Growth and Form

The two-volume edition is
back in print, for
\$27.50 postpaid

from:
Cambridge University Press
510 North Avenue
New Rochelle, N. Y. 10801

or WHOLE EARTH CATALOG

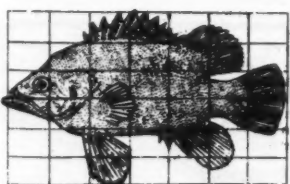

p.37

Ferro Cement

The special ferro cement reprint we said was from
National Fisherman is actually from

International Marine Publishing Company
22 Main Street
Camden, Maine 04843
\$1.00 postpaid

p.66

Supply and Demand

We gave the wrong publisher.
It's available from

Cambridge University Press **\$1.35** postpaid
32 East 57th Street
New York, N. Y. 10022

or WHOLE EARTH CATALOG

Corrections continued...

p.77

Colour Guitar

Old review mentioned that the tuning of the colour guitar is different from the traditional. Colour Guitar is tuned in perfect fourths, straight across EADGCF. This makes fingering patterns consistent everywhere on the neck. I would hate to mislead anyone.

Thanks,
Dave Guard

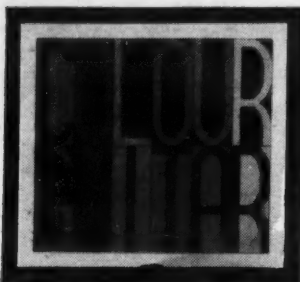

Colour Guitar
Dave Guard
1967; 23 pp.; illus.
\$15.00 postpaid

And the address
has changed, too.
It's now:

Britannia Enterprises, Ltd.
Box 5582
Stanford, CA 94305

or WHOLE EARTH
CATALOG

"CORONA" GRAIN MILL

for use with
wheat, corn, nuts,
etc. Easily adjusts
for fine or coarse
grinding. New 1 CTSP
model mill with finer
grinding plates **\$10.95**
postpaid. East of
Rockies add \$1.00
postage. Finer grinding
plates for old 1 C
mill \$1.95 set postpaid.
Add 4 1/2% sales tax in Utah.

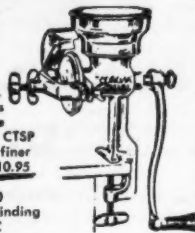

from:
Smithfield Implement Co.
99 North Mark Street
Smithfield, Utah 84335

p.78

Erewhon Trading Company

They're about to lower prices, and
a new catalog will be out soon.
They now have two stores:

Erewhon Trading Company, Inc.
342 Newbury Street
Boston, Mass. 02115

8003 Beverly Boulevard
Los Angeles, CA 90048

p.79

The Impoverished Students' Book of Cookery, Drinkery, & Housekeepery

Price up from \$1.25: **\$1.50**
postpaid

from:
Doubleday & Co.
501 Franklin Avenue
Garden City, Long Island
NY 11531

or WHOLE EARTH CATALOG



p.83

Massage: Principles and Techniques

The publisher has a West Coast
distribution center, too:

\$6.00 postpaid

from:
W. B. Saunders Company
900 Stierlin Road
Mountain View, CA 94040

or WHOLE EARTH CATALOG

p.84

Dear Dr. Hippocrates

Now in paperback for **95¢** postpaid

from:
Grove Press, Inc.
315 Hudson Street
New York, N. Y. 10013

or WHOLE EARTH CATALOG



6

p.86

Happy Baby Food Grinder

Formerly \$4.20; now **\$4.95**
postpaid

from:
Dolly Lundberg
4036 Waterhouse Road
Oakland, CA 94602

p.110

Baby and Child Care

Reduced from
\$1.05 to \$0.95
postpaid

from:
Pocket Books
1 West 39th St.
New York, NY
10018

or WHOLE EARTH
CATALOG



p.113

I Know a Place

Price was \$2.45; it's now **\$3.40** postpaid
with 20% off to schools.

from:
City Schools Curriculum Service, Inc.
60 Commercial Wharf
Boston, Mass. 02110

or WHOLE EARTH CATALOG

p.114

Thinking Straighter

We gave an incorrect listing of the
publisher. It should have read

Kendall Hunt Publishing Co.
131 South Locust Street
Dubuque, Iowa 52005 **\$4.75** postpaid

or WHOLE EARTH CATALOG

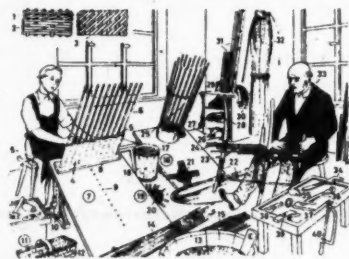

The English Duden

Germany revalued. Was \$5.55; now **\$7.95**
postpaid

from:
Adler's Foreign Books, Inc.
162 Fifth Avenue
New York, N. Y. 10010

p.121

Self-Hypnosis

The Wilshire Book Company has moved.
Their new address:

Wilshire Book Company **\$2.00** postpaid
12015 Sherman Road
North Hollywood, CA 91605

or WHOLE EARTH CATALOG

Using Libraries Effectively

Up from \$1.95. Now **\$2.25** postpaid

from:
Dickenson Publishing Company
Belmont, CA 94002

or WHOLE EARTH CATALOG

Three items inadvertently left out of the Fall CATALOG

American Boys Handy Book

Dan Beard's American Boys Handy Book was
first published in 1882. Out of print for a
long time, Tuttle has finally reprinted it. This
is barefoot-boy-with-cheek-of-tan stuff; detailed
lore on how a boy may make his own world.
Extraordinary book, highly recommended for
funky schools or communities, especially if
woods are handy.

[Suggested by Arthur Brand]

The American Boys Handy Book

D. C. Beard
1882; 391 pp.

\$3.95 postpaid

from:
Charles E. Tuttle Co., Inc.
Rutland, Vermont 05701

or WHOLE EARTH CATALOG

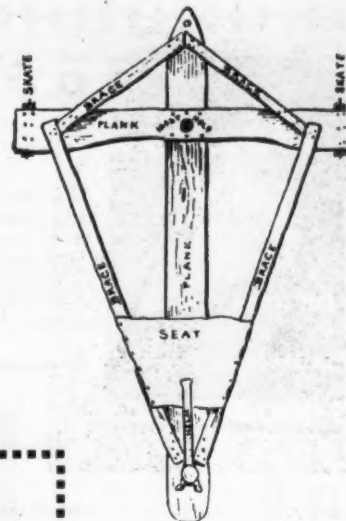

FIG. 188.—Top View of Ice-Boat.

Fieldbook for Boys and Men

The Scouts continue their tradition of
excellent feedback from an increasingly
enormous membership. The Second Edition
(1967) of the Fieldbook may well be the
best value around. Of course, the context
is short term camping out in the continental
U.S., but much more is afoot. In taking us
sure-handedly from the root-hog-or-die
survival situations through toward gourmet
ecology, the Fieldbook shows how far
we've come and certainly what to do next.
The spirit of the Boer War appears to be
giving way to that of enlightened naturalism
(don't go blazing trees—the landowner will
never have us back). Full of recipes,
checklists, buying guides, patterns and
plans, close-up photographs in how-to-do-it
sequence. If you'll need to know something,
it's there.

Having put us at home outdoors, the book
opens up into biology, geology and astronomy,
and what to do about them. I especially
like two sections: one has pictures of wild
plants to eat where you're starving to
death, and the page that tells you not to
apply the tourniquet except as a last resort.

[Reviewed by Dave Guard.
Suggested by Eugene Schoenfeld]



No time to wait to bring victim to
shore. Start rescue breathing immedi-
ately. Tilt victim's head far back.
Cradle his head with one hand and
grasp his jaw with the other. Open
your mouth wide and take a deep
breath. Blow air into the victim
through nose or mouth. Keep it up
as you bring him to shore.

Fieldbook for Boys and Men

Boy Scouts of America
1967; 565 pp.

\$1.95

from your local Boy Scout Dealer

We Built Our Own Computers

Time was, kids built their own radios. Now
it's rockets and computers, and so much the
better. Once you've built one computer you
have a far more sophisticated relationship with
all computers. This British text, prepared by
five school boys who indeed built their own
computers, is an excellent introduction to
hands-in technique.

[Suggested by Jane Burton]



We Built Our Own Computers
ed. A. B. Bolt

\$1.95 postpaid

from:
Cambridge University Press
32 East 57th Street
New York, N. Y. 10022

or WHOLE EARTH CATALOG

or WHOLE EARTH CATALOG

The following titles are, in fact, available from the Truck Store.

Page	Title
23	National Electrical Code 1968
29	Architectural Graphic Standards
36	Architectural Research on Structural Potential of Foam Plastics for Housing in Underdeveloped Areas
38	New Sources of Energy
56	Indian Crafts and Lore
56	How to Make Cowboy Horse Gear
56	Modern Art of Candle Creating
57	New Science of Strong Materials
58	The Natural Way to Draw
72	Horns, Strings and Harmony
73	Improvising Jazz
75	Bookmaking
80	A Manual of Simple Burial
84	The Merck Manual
84	The Merck Index
87	Snugli Baby Carrier
93	Handbook for Conscientious Objectors
124	The Five Ages of Man

WHOLE EARTH TRUCK STORE
558 Santa Cruz Avenue
Menlo Park, CA 94025

Item-related Information

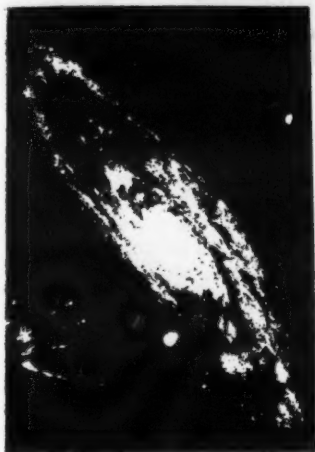

p.7

Galaxy Price Change

The splendid black & white photo poster of *The Andromeda Galaxy* has gone up from \$6.00 to \$7.50

postpaid
from:
WHOLE EARTH CATALOG

OR
Edmund Scientific
100 Edscorp Building
Barrington, N. J. 08007

p.8

Ida Rolf

There is now a **Bulletin of Structural Integration** expanding on *Ida Rolf's whole-body techniques*. \$10/yr. from:

Bulletin of Structural Integration
1334 23rd Street
Santa Monica, CA 90404

VITA in USA

Volunteers for International Technical Assistance have a domestic division (referred to as VITA/USA) that provides free technical assistance to individuals and groups working in or with low-income communities and individuals. You might consider including some information from the enclosed brochure in the next supplement to the Whole Earth Catalog. I have been able to get some assistance from them in the past few months (in technical areas like security sales law for cooperatives in California and funding sources for community schools) since I am on the staff of the Community Action Program for Kern County. The major difficulty in getting assistance from VITA/USA is the process of information flow within that group. A request is assigned to one of the staff who then finds the right technical assistant in the area you need help with (this person might be out of state so that the communication must be by letter or telephone). At any rate you might find this service useful to the Catalog readers.

Sincerely,
Keith R. Prior
Bakersfield, CA

HOW TO APPLY

Please follow these directions in your letter of request for aid.

1. Describe your project in detail. Include rough sketches when helpful.
2. List any special requirements, or limitations that apply.
3. Indicate deadline for action; also urgency of project.
4. If project requires on-the-spot consultation, please add reasons; also estimated days required, and most convenient dates for visit.
5. Describe results and benefits expected.

Be sure your letter shows complete address, zip code and telephone number. Indicate your affiliation with an agency or business, if any.

Mail your request to:

VITA/USA
College Campus
Schenectady, N. Y. 12308 Telephone: 518-372-5696

p.25

Plastics

On page 55 of your Spring 1969 issue, you ask, "Does any reader know of a thorough book—up to date—on the techniques of working with plastics?"

Yes! **Plastics as an Art Form** by Thelma R. Newman, published by Chilton Co., Philadelphia, 1964. The book is about \$9.—and worth every dime. The author is an artist and a plastics engineer. A complete book for amateur or professional artist.

Wendy Reasenber
Watertown, Mass.

WATER AGAINST AIR

Temperature °C	Surface tension dynes/cm.	Temperature °C	Surface tension dynes/cm.	Temperature °C	Surface tension dynes/cm.
-8	77.0	13	72.99	40	69.50
-5	78.4	18	73.50	50	67.01
0	79.8	20	72.75	60	64.18
5	74.9	25	71.87	70	61.4
10	74.22	30	71.16	80	58.8
				100	56.9

INTERFACIAL TENSION

Surface Tension at the Interface Between Two Liquids
(Each liquid saturated with the other)

Liquids	Temperature °C	γ	Liquids	Temperature °C	γ
Benzene-Mercury	20	357	Water-Hoplytic acid	30	7.0
Ethyl ether-Mercury	20	379	Water-n-Hexane	20	81.1
Water-Benzene	20	35.00	Water-Mercury	30	375
Water-Carbon tetrachloride	20	45.	Water-n-Ortane	30	60.8
Water-Ethyl ether	20	10.7	Water-n-Butyl alcohol	30	8.8

p.54

Dyes

The only dyes which seem to be consistently available are Rit Dyes, which are easy to apply but are dull-colored and fade rapidly when washed. A San Francisco store, Local Color, sells mail orders of Procion dyes along with instructions on their use. Their handout states, "Procion Fiber Reactive Dyes, discovered in England in 1956, are quite different from other dyes in several respects—brilliance of color, simplicity of application, and fastness to light and washing. Procion dyes are applicable to cotton, linen, rayon and silk. (They will *not* dye synthetic fibers or cotton treated to be drip dry or crease resistant. They are not suitable for dyeing wool.)"

I've used Procion dyes to tie-dye sheets and to dye clothing, and the colors remain brilliant after a year of weekly washing, and they stopped running even minimally after the first two times. The available colors are

Yellow
Orange (actually a yellow-orange)
Scarlet
Brilliant Red (Fuchsia)
Brilliant Blue
Navy Blue
Olive

Scarlet or brilliant red combine with yellow for a bright orange, navy blue and fuchsia for purple. There is no way with the above colors alone to make a bright green, but terra verde can be made by combining yellow and bright blue. (Bright green can be made by dyeing turquoise cloth with yellow.) The results are invariably a flash.

The process takes about two hours per color; each packet can probably dye at least 30 sheets. Prices are

2 oz packs \$1.50 each, with bulk prices available on request to schools and licensed businesses. Small orders add \$.50 handling charge, and orders over 1 lb., add 1 lb. to total dye weight (for packing) and ask Post Office for rates. Order from

Mr. Glen Black
1414 Grant Avenue
San Francisco, CA 94133

(phone: 415-362-8117

Larry Koenigsberg
Eugene, Oregon



Bloodroot Red
(*Sanguinaria canadensis*)

p.78

Grain



On p. 78 of the Fall, '69 catalog you mention grain from Deaf Smith county, with sources. A cheaper source is Arrowhead Mills, Box 866, Hereford, Texas. Prices: 50 lb. Whole Wheat flour: \$4.50; 50 lb. unground whole grain wheat: \$3.75; corn and rye ditto; 60 lb. soybeans, \$6.00. These are wholesale prices, but I don't think they're too choosy. Also, on whole grains, there's a 20% discount for orders over 200 lbs. Prices f.o.b. Hereford. Write them for details.

Love,
Brad Lane
Austin, Texas

p.45

Handbook of Chemistry & Physics

Your catalog lists the most expensive edition, \$22.50. I believe a student edition with all the same stuff in it is available. Beware of Chem. Rub. literature they don't always mention the cheap edition.

Ron Vane
Boulder, Colo.

Handbook of Chemistry and Physics

Robert C. Weast, ed.
1918 . . . 1968
(49th Edition); 3604 pp.

\$22.50 postpaid

from:
The Chemical Rubber Co.
18901 Cranwood Parkway
Cleveland, Ohio 44128

or WHOLE EARTH
CATALOG

Graphic Terminal

Enclosed is information (circled) for a review of Tektronix. The Tek. 7000 series will be the popular 'scope for the predictable future (i.e. on the order of 10 years); 'scope users would be years ahead to learn the new 7000 series rather than the 500 series. *Graphic* input-output remote computer terminals (as in "2001") are the way to trip, yes? They beat teletypes and CalComp mechanical curve plotters (or pladders) for speed and interaction. Graphic terminals are currently the best ('tho little used) computer-human interface for scientific/engineering (vs. accountant) problems; and graphics should replace catalogs, sales personnel, trips to the store, & maybe option-designers in the 1970's, as a home tool. Tek's T-4002 and other graphic terminals using Tek's storage CRT (TV screen), are far cheaper means of displaying large quantities (3000) of alpha-numeric characters or high-resolution drawings, than the commoner conventional CRT plus magnetic core or other storage unit.

Tektronix seems a nice environment for electronics engineers (me): lots of freedom & informality (work when the mood strikes, 24hr. access to buildings, no suit &/or tie image), active in education of employees & community (gifts & heavy discounts to schools), as well as the usual excessive pay and excessive equipment to play with. (The universities which I know irradiate the community with free/cheap information (software), whereas they should be distributing tools/games/toys/hardware (photo film computer everything that must be actively used not passively sat-at), to everyone who enjoys playing with tools).

Larry Greisel
Gresham, Ore.

Tektronix Catalog
1968; 336 pp.

free

from:
Tektronix, Inc.
P. O. Box 500
Beaverton, Ore. 97006



p.74

7

Food

Your last CATALOG lists the MEALS FOR THE MILLIONS FOUNDATION address incorrectly. The source for Multi-Purpose Food, which we have used, with good results and economy, for years is 1800 Olympic Santa Monica, CA

George von Hilsheimer
Orange City, Fla.

Modern Utopian

Modern Utopian is now a part of Alternatives Foundation! The latest address that I have is Box 1264—Berkeley, CA 94701, but they moved recently to Sonoma County. They are publishing Modern Utopian for \$4/year, Vision, an excellent newspaper of social change, for \$2/year (8 issues) Directory of Communes for \$1; People Directory for communal listings. Group Dating; by becoming a member of Alternatives! for \$10 you get all this and a few extras. They are also starting an experimental communal living experience where people can live & participate in their commune for several months.

Laura Luce
San Rafael, CA

Federal Assistance

Since it is free it seems funny to be critical of the *Catalog of Federal Domestic Assistance* (CoFDA) but Mr. Reed's use of the word "wishbook" is quite appropriate when applied to the CoFDA. The book itself is valuable as a source to find legislation that provides for some programs and to connect with an office that is relevant to the program. The CoFDA lists a large number of programs that have no money allocated to them (or the little money that is appropriated is "eaten up" by administration). Other programs are in a state of financial, administrative and policy limbo due to the change of administration (as with the NYC, Operation Mainstream and other programs of the Department of Labor's Manpower Administration).

Another problem in using the CoFDA is the maze of offices, sub-offices and regional offices that it becomes quite a hassle to get to the Field Representative for your area (*The Regional Office Directory with Maps* published by the SERINA Press — 70 Kennedy Street, Alexandria, Virginia 22305 for \$4.95 may be of some assistance.)

Anyone seeking Federal Grant Funding or Federal Loans should get a copy of the *Grant Application Guide* from the Kings County United Good Neighbor's Council of Planning Affiliates in Seattle, Washington. The *Grant Application Guide* includes: Guidelines for a Successful Funding Application, Developing the Project Proposal, Locating Project Funding, The Proposal Review, Applications to Federal Agencies, State, Federal and Local Public Funds, Basic Grants Information Resources, A Proposal Application Guide and a Funding Resources File (which includes the CoFDA).

The *Grant Application Guide* may be a great time-saver to those seeking program funding (especially the applicant that is unfamiliar with bureaucracies) and, since it is free, is worth the trouble to get.

Beyond Left & Right: Radical Thought for Our Times edited with an introduction by Richard Kostelanetz is a good collection of essays dealing with whole and partial systems. The list of contributors includes: Kenneth Boulding, R. Buckminster Fuller, Gaylord Nelson, Paul Goodman, Robert Theobald, Marshall McLuhan, Simon Ramo, C. A. Doxiadis, Moshe Safdie, Herman Kahn and a whole slug of others (26 in all).

Sections in the book include several essays each and are fairly well divided to provide fast access to information at the level desired.

Sections of the book are entitled: Man and His Future, Technology and Society, Enterprise and Remuneration, Architecture and City Planning, People and Resources, Education, Defense and Diplomacy and Redesigning Society. Mr. Fuller has contributions in half of the sections of the book.

The book is in paperback for only \$2.95 by Apollo Editions (William Morrow and Co., Inc.) 425 Park Avenue South, New York, N. Y. 10016.

Pan y Justicia,
Keith R. Prior
Bakersfield, CA

Lightweight Camping Equipment

Concerning "Light Weight Camping Equipment and How to Make It" by Cunningham and Hansson: Groovie reading on its own if you're into making things. . . .

Some of the problems undoubtedly come from the fact that the tables and charts tend to contradict each other. Have Cunningham and Hansson actually tried making their own equipment using the information in this book? At any rate, the best thing to do is consult a local retailer/manufacture about construction problems.



With a little innovation and using the information in this book you can come up with custom-made equipment which, very often, will be cheaper than a similar store-bought item.

Steve Clarke
San Francisco, CA

Gerry

Gerry Outdoor Equipment is now available by mail order only from:

Alaska Sleeping Bag Company
710 N. W. Dawson Way
Beaverton, Oregon 97005

Book of Survival

Anthony Greenbank's excellent Book of Survival is in paperback this February for \$0.95 from:

New American Library
1301 Avenue of the Americas
New York, N. Y. 10019

or WHOLE EARTH CATALOG



BMW

A comment on your recommendation of BMW motorcycles in the latest catalog. I bought one in 1960 because of their great reputation. It did not live up to its reputation. During my first 3 months ownership and first 5400 miles while it was still under a full parts & labor guarantee, it had three different major breakdowns. Butler Smith the N.Y.C. distributor charged me \$20 to repair the defect on the machine even though they admitted it was a manufacturing defect and even though it was still covered (supposedly) by a full parts-labor guarantee. (Since then they changed their guarantee). I wrote BMW—Munich about the whole thing enclosing my bill and a copy of their guarantee. They refused to do anything about it. Other people I've spoken to have also been dissatisfied with their BMWs.

In the way of bikes I would be inclined to look to Honda where you get more motorcycle, less hassle and a better service organization and parts supply setup for your money.

In motorcycles as in optics the German reputation has outlived the reality and the Japanese are making the real McCoy now.

Yours truly,
Stephen Rowe
Madison, Wisc.

Film Guides

1. You should warn readers that the *Educator's Guide to Free Films*, although an important reference guide does list a lot of poor films and should be used with care.
2. The *Index to 16mm Educational Films* is now published by the Bowker Company (as of Sept. 1969), not McGraw-Hill.

William Sloan
New York, N. Y.

R. R. Bowker Co.
1180 Avenue of the Americas
New York, N. Y. 10036

New Schools Exchange

The "New Schools Exchange Newsletter" requests that at least 3 months subscription be paid for in advance (at \$3). Year subscription is \$10.00.

Sincerely,
Jeffrey T. Atwood
West Hartford, Conn.

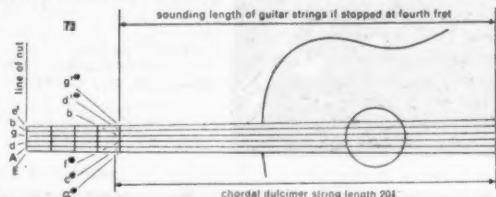

Dulcimers

I have noticed in the Supplement's to the Spring Catalog Some questions Regarding Dulcimers. the following are Four Address which make Dulcimers & Dulcimer Kits.

Here Inc. 410 Cedar Avenue Minneapolis, Minn. 55404
Homer C. Ledford 125 Sunset Heights Winchester, Ky. 40391

Appalachian Dulcimer Corp. 232 West Fredrick St. Staunton, Virginia
The Dulcimer Shoppe 620 E. Broadway Forrest City, Ark. 72335

All of these addresses responded with price lists & descriptions. the prices Range from \$18.00 For a Kit to \$125.00+ for a completed Dulcimer. I ordered a Kit from Here Inc. It arrived within 10 Days with comprehensive instructions for Assembly. For other names of manufacturers consult Sing Out. Jean Ritchie also makes Dulcimers But I have no information concerning her at this time.

Sincerely,
Rick
Wooster, Ohio

Commune Finding

1116 W. Lindsey Ave.
Philadelphia, Pa.
October 15, 1969

The Whole Earth Catalog
Portola Institute
558 Santa Cruz,
Menlo Park, Calif.

Dear Friends,

Sorry as I was to see "Stock Answer No.1" in the September 1969 Supplement I understand it: necessity. Obviously you cannot act as a clearing house. But that's a pretty discouraging reply. For isolated individuals starting a commune is not at all as easy as you think.

Well, somebody has to help out people like the Kelcos. Guess we're elected. Penny and I have lived through the squalor of three more or less unsuccessful communal ventures. Hope like in the Indian legends fourth try works. Meanwhile we ran a workshop via the Free U. here to try to pass on our experience of what doesn't work.

So why not send those strays our address along with the turnoff, at least those in our area. We'll try to explain to them what to expect. And try to help those who seem fit find a place. After all, not everyone fits every commune. Picture an acid head on a kibbutz, or a "chalutz" type with the Hog Farmers. And who knows, some of them may find a place with us. No sociologists of course.

By the way, we like the Catalog. Full of good ideas along with the trash. I'm no lover of the great "Bucky" though; not while metal and plastic fossil structures mow strip mowers, etc. Just what is progress? Inflating shelters cheap, but your fan that keeps them up burns coal! And what's so damn sacred about the status quo of production, besides the power of those that profit.

For those of you readers who might be interested my formal training is in physics. I'd be willing to help out design water or wind power plants for any contemplating such installations. That 200 watt unit is a joke. At full power it would take five years to pay itself off (at 10¢/kwh).

Yours for the Revolution,
Michael D. Hirsch

New Suggestions

Concerning the following suggestions, if you have further information on suggested items, either pro or con, please let us know.

Construction

You might review the following for catalog listing: The Construction Bargaineer/P.O. Box 1061/St. Paul, Minn. 55105 \$4/year; 24 issues/this is catalog of catalogs & direct advert. of new/used/govt. surp. construction equipment (earth moving equip.; portable elec. gen.; trucks) and other light & heavy mechanical equipment. (I've never bought from them so can't give judgement).

I have several references to a variation of hydroponic gardening using expanded vermiculite. If you are interested in filling hungry bellies vs. implementing/illustrating a philosophy, then this looks good. One author claims you can feed a family of 4 from 200 sq. ft. (vegetables only, grown outdoors). By growing in a better climate or indoors with supplementary lighting (I have references on this, too), this could certainly be improved. I'm going to try this as soon as possible. If you want refs., let me know. [We do.]

Charles T. Vollers
Seneca, S. C. 29678

The Future of the Future

The Future of The Future; John McHale; George Braziller; \$9.00

"The future of the past is in the future
The future of the present is in the past
The future of the future is in the present"

The Future of the Future is written in sociologese which may put you off / don't let it / this is a very hip book / a good hard straight look at what's really happening in the real world of advanced thinking & technology / the future of the future looks good as long as we start busting our asses / straightaway

John McHale says with Jackie Lomax- / "There's a new day dawning-& I think it's gonna be alright-cause I can almost see the light-of the new day"

Peter Douthit
Libre, Colorado

"Our highest futures priority lies with social invention--"

"But memory continually reshapes our biographic past in the same way that our selective perception and means of communication screen the present and future."

"Part of the ongoing utility of perfected forms is in their tacit dimension of unreachability--"

"The task . . . is to disentangle ourselves and our societies from those linearly deterministic theories of history that have come, almost, to replace history itself."

" . . . we must also move, concomitantly, to assume conscious responsibility for the overall stewardship of this planet."

"Organized information is now our major tool resource."

"Science . . . is another form of art, defined primarily as a symbol-ordering and verification activity."

"Technology may be as natural a part of human evolution as the differentiation of finger and thumb. . . ."

" . . . the arts and other communication modes have enormously expanded his *psychic* exploration in space and time."

"The extension of knowledge in science, for instance, has not been through the simple addition of new facts but rather through the grasp of ways in which a great mass of factual information may be simply and elegantly structured into new conceptual wholes."

"With the decline in importance of heavy industry, the invisible ubiquity of miniaturized technologies and the increasing detachment of human energies from direct industrially productive work, we come toward a post technological society, just as we are now in a post agricultural stage."

"To address ourselves to the questions of a planetary society is no wishful utopian fantasy but a sober recognition of everyday facts."

"Who is defending whom against what?"

"Politics is . . . now more the art of attempting to avoid the inevitable."

"The key to many of our difficulties lies in the identification of those social orientations that in the past had great survival value, but which may now endanger our survival in the present, or cripple our approach to the future."

"Work, as previously defined, is no longer the central life interest. It has lost its relation to the compulsive work ethic, to the principle of nationality and efficiency, and the notion of time as money, that is, as a scarce commodity and socially significant unit."

Vivid Fatherhood

SUGGESTION FOR WHOLE EARTH CATALOG

Name of Item: HUSBAND-COACHED CHILDBIRTH by Robert A. Bradley, M. D. (N. Y.: Harper, 1965) 206 pp. Introduction by Ashley Montagu.

Price: \$3.95

Order from: Harper & Row
49 E. 33rd St.
New York, N. Y. 10016

Review:

Birth without the father is like a wedding without the groom. The idea of the father being present for the birth itself, to reassure his wife, to share the experience, and to help, is so obvious yet so new that it needs an advocate as determined and compassionate as Dr. Robert A. Bradley. This pioneering book does not patronize fathers with the belittling cliché about "playing a role". Bradley sees the father as an essential partner in conception, in exercises during the entire nine months, and in the delivery room itself. The word "coach" is well-chosen, for the husband should be directly involved in encouraging his wife during the prenatal exercises (the Dick-Read natural childbirth method).

Bradley's book is based on 17 years of obstetrical experience; he claims to have presided at over 7,000 births without loss of a single mother. When he first began experimenting with natural childbirth, Bradley noticed that wives were more at ease and more cooperative when their husbands were nearby in the labor room than when their husbands were later sent out. He especially noticed that the mothers' joy at birth was mis-directed to obstetricians, and he concluded that fathers really belonged on the obstetrical team.

Bradley agrees with Montagu that home is the optimum environment for birth, and notes that 96.4% of births are trouble-free, but says the 3.6% chance of complications dictates that birth should be in a hospital. The father replaces the anesthetist who is not needed for natural childbirth. He is surgically clad, sits on a stool at the head of the bed, and wields a moist cloth and words of love and encouragement. Bradley urges husbands to bring a camera for "daddy pictures" of mother, father, and infant together. All three can return home on the same day.

A couple wanting to share this experience should make whatever effort is necessary to locate a doctor and hospital that will cooperate. Bradley gives the address of the International Childbirth Education Association, Box 5852, Milwaukee, Wis. 53220 for further advice on fighting restrictions against the father.

Reviewed by Gene Keyes
Carbondale, Illinois

Bikes

Why not put *Cyclo-Pedia*, a catalogue and handbook about bicycling into your next book. It is made by Gene Portuesi, 6447 Michigan Avenue, Detroit, Michigan 48210. It sells "Bobet" bikes which are damn good, and other accessories, but it also throws in a lot of good bullshit about camping and riding about on derailleur bikes. I have the seventh edition and I imagine that there must be a more recent one than but I really can't tell you any more about that sort of thing.

Paul Levy

Shower shoes

Beach Walk Sandals are not so special but they are the only zoris around that last for two to four months of all-day outdoor wear and don't collapse after a few days and leave you fearfully on your heels. Cost about a buck. Buy them in Shoe Stores and Repair Shops.

Peter
Zen Mountain Center
Carmel Valley, CA



Notice All Personnel

It is recommended that your headquarters screen the several hundred thousand Department of Defense field manuals, technical manuals, pamphlets, and other publications for possible inclusion in your catalog.

Thank you.

Joel Graber
Captain, US Army
APO San Francisco

Roger Knights Suggests

Arthur H. Thomas Co., Box 779, Phila., Pa. 19105 is another scientific apparatus company which may send you a huge catalogue if you ask them nicely. (Phone no. is (215) MA7-5600)

Used, lo-cost sewing machines can sometimes be bought at Singer's if you can convince them that you don't have enough money to buy a new one. They seem to have a policy of denying that they have any used ones on hand, in order to encourage sale of the more expensive models. If they do this, and you suspect it isn't so, it might be worth trying again in a week or 2 "to see if anything's been traded in". It worked once, that I know of.

The only adequate (phonograph) record-cleaner around is the "Parostatic Disc Preserver", mfd. by Cecil Watts Ltd., Darby House, Sunbury-on-Thames, England. It's a fuzzy black cylinder which is applied to the record for a revolution or two before playing it, & which picks up all the groove-lint, etc. on it. The cleaner itself is cleanable (unlike "record cloths") by rubbing one's thumb down it. It needs watering about once a month, and will last for years. If the local record store doesn't have it, it can be ordered from Sam Goody's, 4635 54th Road, Maspeth, L.I., N.Y. 11378 for \$4, plus 1.50 shipping charge, plus 5% sales tax for N.Y. State residents.

Roger Knights
New York, N. Y.

How About an America Cup Wheelchair Race?

What do you do—and you might answer this question in your next edition—with the poor people who cannot walk and who have just enough to buy a vehicle for 100 or 200\$? And who risk to be fitted into their wheelchairs like the victims of Procrustes, the figure of Greek mythology, who put his short people in long beds and long ones in short beds, stretching the legs or cutting them off accordingly.

Well, there is a good book out for those 400000 people or so, to speak only of USA. See the enclosed clipping.

Herman L. Kamenetz, M.D.
State Veterans Hospital
Rocky Hill, Connecticut

THE WHEELCHAIR BOOK: Mobility for the Disabled by Herman L. Kamenetz, *State of Connecticut Veterans Hosp., Rocky Hill.* All types of rolling chairs, stands, beds, and walkers along with the services of each are reviewed in this reference manual. Numerous illustrations with explicit legends develop an understanding of the hundreds of features of modern wheelchair design—size, type, construction and accessories. Contains valuable information for professionals as well as laymen. '69, 288 pp. (6 3/4 x 9 3/4), 81 il., 8 tables, \$14.75

Charles C. Thomas, Publisher
Springfield, Illinois 62703

Small Business Administration

The Small Business Administration publishes over 70 bibliographies that deal with differing businesses and functions. These can prove extremely useful to those people contemplating a part time store of their own and single copies are available free from the administration. Small Business Administration, Washington, D.C., 20416.

Mark McCain
Salem, New Hampshire

38. Toys
39. House-to-House Selling
40. Laundry and Dry Cleaning
41. Mobile Homes
42. Bookstore Operation
43. Plumbing and Heating Job Shop
44. Job Printing Shop
45. Men's and Boys' Clothing
46. Woodworking Shops
47. Soft Frozen Dessert Stands
48. Furniture Retailing
49. Warehousing
50. Apparel and Accessories for Women, Misses Children
51. Trucking and Cartage
52. Store Arrangement and Display
53. Hobby Shop
54. Interior Decorating

Savings checks?

united security account
Citizens Bank and Trust Company
Box 48071 Chicago, Ill. 60648

Although it seems impossible, this is a savings account on which you can write checks. The savings earn regular bank interest and serve as collateral for the checks (which are really loans). If you deposit enough to cover your checks by the 15th of the month following the one in which they clear, you pay no interest charge, otherwise you pay a low 3/4% a month (equivalent of 9% annually). Currently there is no charge for checks and deposits are made by mail at the bank's expense. The only things you can't do are write checks for more than you have on deposit or use deposited money to pay off check/loans. I've had one of these accounts since late 1964, and I can't find anything wrong with it. New accounts open at intervals, and you're supposed to be recommended by an account holder, but inquire at the United Security Account Division of the bank for their current policy.

T. J. Spencer
Washington, D. C.

Solar Prints

I would like to recommend a service:

New York Solar Print
736 Broadway
New York, NY 10003

They make good quality photo enlargement from negatives (B&W or color) or from prints. You get originals back. Service is fast. Two years of use: no disappointments. Prices postpaid.

Prices: 16 x 20 \$2.00
20 x 24 3.00
30 x 40 4.50
40 x 50 8.50

T. P. Lowry
Kentfield, CA

IF YOU HAVEN'T NOTICED THESE PRICES ARE GREAT.

Shaw suggests

Lee's *Bookmaking* is indeed an excellent book, but, being in publishing, I must insist that the first book to be purchased is the *Chicago Manual of Style*, which has most of Lee's information about dealing with printers, in condensed form. It does not have any illustrations, however, and gives little information on the actual process of production. It just came out in a new, improved, and excellent edition. Another good, if dry, book, is *Words into Print*, which covers much the same area as the *Chicago Manual*, but gives additional information as well. Consider listing Strunk and White's elegant *Elements of Style*.

Healthkits are good, but for top quality, bottom dollar, and unsurpassed instruction books, Dynakits win by a mile.

The *Physician's Desk Reference* is a guide to all the drugs on the market, giving the generic names keyed to brand names and vice versa. You will probably need a medical dictionary (*Stedman's* is the standard one) to use it, but you can save a bundle by getting away from brand names. Also, you can often get prescription drugs from veterinary supply houses, but the inspection standards and purity standards are much lower.

Kenneth R. Shaw
New York, N. Y.

Biodegradable

Suggestion for Whole Earth Catalog—

Amway products—biodegradable detergents available only from local distributors (anyone may become a distributor for an initial cost of about \$20)

cheap

2 best products—1) L.O.C. (Liquid Organic Concentrate) may be used to wash hands, dishes, clothes (including wool with LOC High Suds which works very well in cold water), hair, fruits & vegetables (to get chemical sprays off) etc.

2) SA8—powdered laundry detergent—use much smaller amount than other detergents

Amway Corp
Ada, Mich.

local distributors in
phone book

Nancy Dorr
Sausalito, CA

Service access

The *Family Store* publication is a nice access service for the Bay Area that is starting to branch out to include other regions. It lists mainly sub-culture services.

The Family Store
Ed Kartman, ed.

\$0.75 postpaid

from:
The Family Store, Inc.
Box 7067
Berkeley, CA 94707



Eekological

Those interested in *The Population Bomb* (p.4) will want to know that an outfit called Population Panel of the Hugh Moore Fund (60 E 42nd St., N.Y.) follows up the Ehrlich book with a FREE newsletter and other assorted information.

The only omissions that I'd say shocked me were:

1) Biodegradable soaps and detergents.
AMWAY Corporation, Amway of Canada, Ltd.
Ada, Mich, 49301 London, Ont. (Dist)

distributes (through local agents, whose names are presumably available from the Co) a whole string of these: S-A-8 Plus is the laundry compound, 14 lbs=\$6.—they also have biodegradable general cleaners.

2) Firefighting equipment. Whether you live in a city or a commune you may need fire protection. If you have electricity, water will not do. As far as I know the best manufacturer of chemical fire extinguishers is American LaFrance, Elmira, N.Y. 14902—they have a whole line.

I suppose this is "Learning": *Ranger Rick's Nature Magazine* (and simultaneous membership in R.R.'s Club) is a marvelous tool for teaching children (and adults) the love and beauty of Nature. It's put out by the National Wildlife Federation, 1412 16th St NW, Washington, D.C. — 10 issues for \$6.—

Robert K. Sarlos
Davis, CA

Does Kinnikinnick Cause Lung Cancer?

Available from: AMERICAN INDIAN TOBACCO & ENTERPRISES
Lamentation Mountain
U.S. Route #5
Meriden Connecticut

Write to: Tall Red Oak

Real and authentic Indian tobacco, several types for different tastes. I haven't tried rolling any in paper yet, but the wet type might do it if cigarettes are your bag. But, the stuff is really for pipers. The Ceremonial tobacco is by far the richest they carry, heavy and black leaf. Western Plains tobacco is in my opinion the smoothest all round stuff, mostly pure tobacco. None of the tobaccos are aromatic in the white man's sense of the word. Don't smell like mixture 79 or the like. BUT, the kinnikinnick, the NON-TOBACCO leaves sold as "Chippewa Straight" is truly the find. No nicotine for you guys who've quit but long to puff on something that won't send you UP. Also, used as a mix with other blends makes the very best smoking.

Mountain Men of the 1840's—traded very heavily for the mixture called Kinni-kinick, (Algonquian for smoking stuff) that was made best by the Chippewas of Bear Berry Leaves and Red Willow bark and other herbs. It smells like the forest. Sitting in New York, the aroma fills the apartment and for an instant, you're away. It helps. Try some.

Mohawk Blend is already a mixture of tobacco and Kinni. Northwest Coast tobacco is heavy and minty.

They'll send a sampler package of three types for \$2.55 inc. post. If you want the straight non-tobacco stuff ask for sampler number two.

Otherwise just write for their free pamphlet on tobaccos and other goodies.

Chuck Rapoport
New York, N. Y.



Philadelphia

In Philadelphia one day I discovered

THE HOW-TO-DO-IT BOOK SHOP
1526 Sansom Street
Philadelphia, Pa. 19102
LO 3-1516

Nice lady runs it, and she seems to have almost every howdy-do-it book ever printed. (I left with books and pamphlets on how to

do a striptease
upholster chairs
organize housecleaning
use peanut butter 100 and 1 ways
repair a VW)

May I recommend it as a place to look for the out-of-print, or not-much-call-for howtodoit book.

Judy Rascoe
Redwood City, CA

Science, ax, projector

A periodical you might mention is *Science Books*, a quarterly published by the American Association for the Advancement of Science (the people who publish *Science*). Most of the reviews are specific and quite nitty-gritty; if they don't like a book, they often cite better books on the same subject. It reviews books right down to the kindergarten level; very helpful in locating non-anthropomorphic, factual, logical, and withal delightful books for young ones. It is much more severe, and better, I think, in this field than the other sources of children's book reviews.

If they're still in business, there's a company in Waterville Maine called Spiller Ax who make remarkable tools. Each ax is hand forged by bending a piece of steel around an eye (for the handle) to enclose a piece of Swedish tool steel (for the edge). They take and hold an edge long after the drop-forged hardware type ax is dull. Last time I was there (around 1959) business was slow, but they had in stock over a hundred different patterns (including things like double-bitted hatchets for camp use, one side for splitting wood, one for chopping, fairly light weight, as well as more reasonable and usual designs.)

Finally, those of your readers who are interested in a 16mm projector should consider what is being marketed here by International Audio Visual Ltd. (119 Blanchard Street, Seattle, Washington 98121) as the IAV MS-860 or 861. These are really the Eiki projectors, made in Japan, and are first rate machines: small and quiet, light weight, modular design with massive castings for the movement, good lens and sound system. Not considering price, I think they are the best portable projector under \$1200—and they were advertised at \$400, brand-new, a while ago by Abbe Films in New York. If you can't swing the \$400, the next best bet is an old Bell and Howell, and have it overhauled when the occasion arises by Milliron in Los Angeles, if you're anywhere near here. They aren't cheap, but they are extremely thorough; you may well end up with a better than new projector.

Best,
John Lord
Santa Monica, CA

Old Car Parts

Very groovy place is Joblot Automotive in Queens, N.Y.—Address: Joblot Automotive, Inc. 98-11 211th St. Queens, N.Y.—they have an almost complete stock of spare parts for all Fords Mercury & Lincolns (including truck parts) going back at least to Model A days, and the parts are mostly original factory parts that they bought up over the years as the dealers and factory decided not to bother stocking them anymore. They have a catalogue and will mail order stuff anywhere. The last time I was there the owner told me that he started out supplying hard to get Model A parts to South America and other places where they were still widely used. When stocks of original Model A parts became scarce people in those countries began manufacturing them domestically to supply the local demand. He now imports a tremendous range of newly manufactured Model A parts and asserted that it would be possible to assemble an entirely new MINT Model A from parts. He is very helpful and should give very satisfactory service.

Larry Nordell
East Setauket, N.Y.



Low-cost drugs

Another thing you might like to list in a future edition is the Celso Direct Drug catalog. The Arthur Morgan School is closely associated with the co-op movement and has championed various consumer causes. For some years we operated *Celso Laboratory Products*, a project for supplying Co-op pharmaceuticals by mail at low cost. Then the Co-ops started their own mail order drug service. At this point we turned our business over to them, but edited and published their catalog. I'll enclose a copy of it. It can be had free by addressing Celso Direct Drug Service, Burnsville, N.C. 28714.

Ernest Morgan
Celso Press
Burnsville, N.C.

Prices on some commonly used

PRESCRIPTION DRUGS

If your drug isn't listed, DON'T WORRY—We fill any prescription!

Brand Name	Generic Name	Quantity	Usual Price	Our Prices	
				Brand Name	Generic Name
Aldactazide	Spiro lactone & Hydrochlorothiazide	100	\$15.30	\$13.60	\$
Aldomet	Methylclopa	100	10.00	7.80	
Antivert	Meclizine & Nicotinic Acid	100	7.35	5.85	
Arlidin 6 mg	Nylidrin	100	6.60	5.40	
Atarax 25 mg	Hydroxyzine w/HCl 25 mg	100	11.65	9.95	
Atromid-S	Clofibrate	100	9.75	8.70	
Bamadex Sequels	Dextro-amphetamine SO ₂ , meprobamate	30	5.00	4.20	
Benadryl 50 mg	Diphenhydramine	100	3.70	3.00	2.25
Benemid	Probenecid	100	10.00	7.50	
Butaxolidin 100 mg	Phenylbutazone	100	9.75	7.25	
Butaxolidin Alka	Phenylbutazone	100	11.00	8.80	
Butisol 1/4 gr	Butabarbital	100	2.60	1.95	1.25
Butisol 1/2 gr	Butabarbital	100	3.45	2.75	1.50
Cardilate 10 mg	Erythryl Tetranitrate	100	3.75	3.05	

Anonymous suggests

I'd like to suggest the TIME-LIFE Reading Program for your consideration. Your review of their Science series was interesting, and accurate. The TRP is much the same.

Once every two months, subscribers to the program receive four large (8 1/2" x 5 1/2") paperback books, each costing \$1.25. You keep the books you want, and ship the others back—getting stung both ways for postage, incidentally.

But the fascination of the program for me is the serendipity they send. The series ranges over fields of knowledge like random numbers from the Dewey Decimal System. They have a TV play about graverobbers written by Dylan Thomas, a collection of the favorite poems of some 250 poets, an architectural history of Notre-Dame-de-Paris; plus novels, biographies, travelogues, history, philosophy, ecology . . .

I had a job last summer with a lot of time on my hands, so I assigned myself to catching up with the accumulation of TRP books. I just took them as they were on my bookshelf, left to right. Travelled with FitzRoy MacLean to Samarkand; saw the 19th century out with Henry Adams; learned that mosquitoes live in levels in forests like fish in the sea, and laughed out loud reading a portrait of Machiavelli in "The Man of the Renaissance."

TRP goes in for books which are difficult to find, if not entirely out of print. Such resurrection is a good thing.

I am advised by friends who worry about such things that some of the volumes are available elsewhere in cheaper editions. If you're like me, though, you wouldn't buy them, but when Time sends them in the mail you're too lazy to send them back. Besides which the artwork on the covers is outstanding.

How you get in is a mystery to me. They had an introductory offer in TIME three years ago (which was when I got aboard) and I haven't seen one since. It's not likely that they'll turn you away, though, if you write them. TIME-LIFE Books, Time-Life Bldg., Chicago, Ill., 60611 . . .

A final suggestion for other tool-gatherers who've noticed the high cost of books in general and reference works in particular: At last! You can make the system work for you!

Yes, you too can manipulate the Establishment! How? Simple—through the intro offers of book and record clubs.

Most every book club has come-on offers to make your mouth water—seventy-three books, all for only thirty-eight cents and two boxtops. Seriously, though, there are some good buys. The condition, of course, is that you buy a certain number of books at member prices in a given time period.

What the clubs hope for is that you stay in. What you do is get out. Fulfill your minimum obligation and resign your membership. The next time a good offer comes up, join. (It helps if you've changed your name or your address in the meantime. If not, join your wife, your kid, your parakeet.) A friend has joined the Mainstream Book Club eight times.

Here's how he does it. Their latest ad offers five books for \$1, if you buy four more books in the next two years. That's worth up to \$85 when you send it in. There's almost no way four book-club books will cost you \$85, so you come out ten, twenty, forty dollars to the good.

(I'd just as soon you didn't put my name down for this, if you use it, because some of my book clubs may get your catalog.)

Detroit, Michigan

Book discounts

The more casual or broke book buyer might like to know where almost every book in print can be bought for either 15% or 33% off list price. The larger discount is available on about half the publishers, the smaller discount on the rest. There is no entry fee to this. . . . An additional good point is that you save sales tax.

Enclosed is the material from E.R. Hamilton. You might like to include his service in the Catalog. He sends order forms, envelopes and the enclosed publishers list free on request.

The very best
David G. Baxter
Los Angeles, CA

from:
Edward R. Hamilton
P. O. Box 1023
Danbury, Conn. 06810

Science House Publishers
*Scientific American Inc
William R. Scott Inc
*Scott Foresman & Co
Charles Scribner's Sons
Seabury Press Inc
Select Books
*Self Help Books
Sheed & Ward Inc
Sherbourne Press Inc

Magazine subscription discounts

Re: magazine subscriptions—one should never subscribe through the magazine itself—do it through

Publishers Clearing House
382 Main St.
Port Washington, N.Y.

They will match any cheaper offer or refund the difference. Write for their current price list.

Donald McKenzie
Berkeley, CA

Cooking High

For those of us living over 5,000 ft up — BAKING AT HIGH ALTITUDE, cake, cookie and quickbread recipes adjusted for cooking about 5000 feet and adjusted again for over 7000 feet cooking. IT IS FREE. Put out by the University of Wyoming. Write for: Bulletin 427 Write to: Agricultural Experiment Station University of Wyoming Laramie 82070

Tom Duckworth
Embudo, NM

A Better Volkswagen Book

John Muir has written what may well be your V.W.'s best friend. In this book you are invited to "Just take the book out to the car with your coveralls on for a guided tour."

So I did. My guided tour of the car and the book's easily versed descriptions convinced me that it is the best I've encountered yet. It's written for the layman (us), and as such makes about 80% of the common V.W. ailments both clear and repairable.

If you take it literally, you will learn to "feel the car" and perform the necessary tasks with love. There are also many pages devoted to what you can do when hung up on the mud flats for one reason or another. While "Volkswagen Technical Manual" contains more pictures of the beast, "Volkswagen Alive" is what I would prefer to have when it's time to unroll the metric wrenches.

Don Burns
Berkeley

HOW TO KEEP YOUR VOLKSWAGEN ALIVE ETC. . . .

OK so here's a good book on how to fix your VW written in a chummy style that will not be too amusing the second time you read it. There's a real collection of tricks and pitfalls that to my mind is well worth the money. But some of them are rehashes of old wives tales are are not true (there's a bit about the VW Understeer. What makes the VW dangerous is *Oversteer*: it steers more than you tell it to. Also, some of the really damnable aspects of repairing old VWs such as headlights that are about as bright as birthday cake candles, are simply and groovily dismissed without telling you how to do anything about it. *HOWEVER* . . . an idiot can actually do major repairs on his VW with the aid of this book, and that, friends, is saying a lot. I would recommend that you have this and the Elfrink book at your side. John Muir also gives lists of tools you need, which hand to hold them in, and when to stop for a morale-building smoke. He also tells you when to quit and what not to attempt. Any VW owner should be able to save the price of the book within a week of getting it. Reading it will aid you in keeping your bug out of the shop in the first place. There's a "how to buy a used VW" chapter too! And he starts out "Come to kindly terms with your Ass for it bears you." Indeed. I'd call it indispensable.

love, Jay Baldwin indeed
who owned the 8th VW in U.S. at
one time. and has driven VW 582,000
miles, in the nonce.
Saratoga, CA

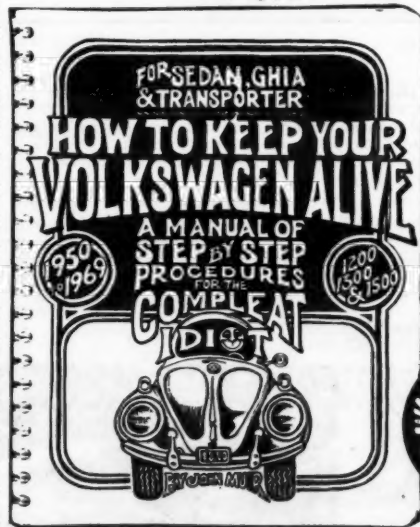

How to Keep Your Volkswagen Alive

John Muir
1969; 242 pp.

\$5.50 postpaid (\$5.72 in N.M.)

John Muir Publications
Box 613
Santa Fe, NM 87501

or WHOLE EARTH
CATALOG

for resale, order from:
Book People
2010 7th St.
Berkeley, CA 94710

Mysticism

A nice supplement to Marshal Lee's *Bookmaking* is *The Design of Books* by Adrian Wilson—Reinhold, New York. Although less comprehensive than Lee's, it gives one a better introduction to the creative possibilities of design. Design books, but magnificently!

For around \$7.00 the U.S. Navy sells, through the Government Printing Office, a training manual called, I think, *Lithographer's Mate 2,3*. It covers a great deal of ground, including some photography, from basic type-setting, Varityping, graphic arts camerawork, platemaking, all the way to running various types of litho presses. It seems to be pretty solid.

The Catalogue has offered people a fair introduction to the various esoteric religious forms: Yoga, Zen meditation, I Ching, the Tao of Lao Tse.

Evelyn Underhill's *Mysticism*—a Dutton paperback, New York, 520 pp., \$2.45—is the best book on Western religious experience. Dealing only peripherally with dogma, theology, the author makes a thorough and well-written comparison of recurrent experience in the inner development of individual Christian and Moslem mystics.

Here we stand suddenly at the confines of human thought . . . it is intensely cold here; it is intensely dark; and yet you will find nothing but flames and light. (M. Maeterlinck)

All there is so still and mysterious and so desolate . . . this Wilderness is the Quiet Desert. . . . (John Tauler)

This is the dim silence where all lovers lose themselves. (John Ruysbroeck)

[It] looks upon itself as one that is placed in a profound and vast solitude whither no creature can come, and which seems an immense wilderness without limits. (St. John of the Cross)

Mysticism concludes with a historical sketch of European mysticism from the beginnings of the Christian era to the death of Blake. The book has an enormous bibliography. Use it or lose it—it's a tool.

I'm surprised that no one seems to have mentioned H.D. Thoreau. Things said in *Walden* are so very basic to the idea of the Catalogue:

I went to the woods because I wished to live deliberately.

I am convinced, both by faith and experience, that to maintain one's self on this earth is not a hardship but a pastime if we will live simply but wisely. . . . it is not necessary that a man should earn his living by the sweat of his brow, unless he sweats easier than I do.

Cultivate poverty like a garden herb, like sage. Do not trouble yourself much to get new things, whether clothes or friends. Turn to the old; return to them. Things do not change; we change. Sell your clothes and keep your thoughts.

We must learn to reawaken and keep ourselves awake, not by mechanical aids, but by an infinite expectation of the dawn . . . I know of no more encouraging fact than the unquestionable ability of man to elevate his life by a conscious endeavor. . . . To affect the quality of the day, that is the highest of arts.

The cheapest edition of *Walden* seems to be the Harper & Row Perennial Classic, at \$.50.

Dan Gridley
San Francisco, CA

Square Dollar

It really bugs me that so few people (that I've met, anyway) know anything about Square \$ Books. The enclosed review should give you the picture of what they are about. Suffice it to add that on the back cover of the Agassiz book, printed in 1953, Marshall McLuhan, probably one of the most observant men around, is listed as one of the five members of the Advisory Committee.

The Agassiz book isn't really so good, it emphasizes all of what I would consider his worst qualities . . . attempts to see a divine plan in nature. There are better Agassiz books, like *The Intelligence of Louis Agassiz*, by Guy Davenport (Beacon Press, 1963, \$5); but the Fenollosa book definitely belongs in your Communication section, and the money books might well fit in with your stuff on economics (I haven't read them).

The Pioche, Nevada, address is two years old, but I think it is probably still valid. T. David Horton is a lawyer, must be an interesting man.

A book that fits in well with these and is cheap (the Square Dollar Books are all \$1) is *ABC of Reading* by Ezra Pound, an excellent antidote to college lit courses. The theme is "don't believe what you're told, get off your hind and find out for yourself." Pound also discusses writing here. *New Directions*, NDP89, \$1.45, 333 Sixth Ave., New York 10014. If the commune people are book-freaks (bead-game players?) like me, they might benefit from Pound's medicine.

Frank Deis
Richmond, Va.

SQUARE \$ SERIES. T. David Horton, P.O. Box 507
Pioche, Nev. 89043

1. *The Chinese Written Character* as a medium for Poetry, by Ernest Fenollosa, (and in the same volume) *The Unwobbling Pivot* and *The Great Digest*, of Confucius, translated by Ezra Pound
2. *The Analects of Confucius*, translated by Ezra Pound
3. *Gists from Agassiz* or *Passages on the Intelligence Working in Nature*.
4. *Barbara Villiers*, or a History of Monetary Crimes. by Alexander Del Mar.
5. *Bank of the United States*, by Thomas H. Benton
6. *Del Mar on Roman and Moslem Moneys*

Randy Chakerian suggests

Back in the Nomadics section: There's an extremely useful book published, again in paper, by Harper Colophon Books, CN128: Peter Farb's *The Face of North America, The Natural History of a Continent*, published in paper in 1968 for \$1.95, with 316 pp. It has extremely good illustrations, both photographic and other-graphic, a very good index, and an easily readable style which incorporates the too-often-disparate sciences of the earth, which makes it sort of a book on ecology without trying to be one, which is going to be, I'm afraid, increasingly a recommendation. What with *Life and Time* and every other subscription-oriented journal picking up on Ecology as a way of the future, along with David Eisenhower, Julie Nixon, and Birch Bayh, of course, it's already about to die a quick death. Even the saltiness of the people who know what they're doing in it isn't going to save them from that all-swallowing sea. But what the hell, that's their problem. Farb talks in turn about the Coasts, Inland Waters (all kinds), Mountains, Forests, and Drylands, along with a short, too-short section at the end on Man's Imprint. However, that shortness is what saves it from being just another book on Ecology, which is after all essentially for and by human beings, no? The best part of the book, and one which makes it worth the price, is the almost-40-page section at the end called "Outstanding Natural Areas of North America, by State and Province." He gives an incredibly complete listing of National and State (or Provincial) natural areas of varying degrees of wildness, along with a brief characterization of what kinds of natural features can be found there, especially the unique or rare ones. These almost inevitably tie into the Index, and can be read about in their more abstract (ecological?) context in the text of the book itself. It seems like a drag that he should list only politically set-aside areas, until you realize two things: 1) there ain't any other areas you can legally go to, as everything is owned, but that's ok because 2) you never realized how few of these wild areas you were acquainted with, and also how easily the areas you did know tie in with the functioning, both present and past, of the whole continent. For once in its history perhaps the Chicago Tribune was right, in its blurb on the paperback's back cover: "This book belongs in the glove compartment of every car." or in your pack. Unfortunately it's too big to stick in your back pocket or even your jacket pocket usually. But maybe that's a good thing too...

Two things about Conscientious Objectors (of whom I am at present an Official One): CCCO is very good, but swamped. To take the load off them a little bit, you might suggest the NSBRO, National Service Board for Religious Objectors, which isn't really for religious objectors exclusively, as you tend to help anyone who looks like a friend when it gets down to being nitty-gritty like this is. Their address is somewhere in Washington D.C.—550 Washington Building, 15th & New York Avenue, N.W., Washington, D.C. 20005. They publish a bunch of pamphlets and things about Conscientious Objection, sort of duplicating CCCO's work, but they publish a compendium of alternative service jobs approved by each State Director's Office, which helps if you want to move around. It also helps if you want to get an idea of how meager the possibilities are, unless you've got time, or imagination, or hustle, to find yourself a good thing. Which I unfortunately didn't. How about publishing in one of your Supplements the suggestion that somebody get together and do a listing of non-profit agencies which CO's might work at, say for room and board? CO's have to work at non-profit things, but it's hard for them to tie-up with things that aren't straight more often than not because they have to get a job right away or they just don't know about things. It would be hard for someone to get a list going—I've thought of it myself, because there are a hundred agencies around the country for helping you get a CO classification, but none to help you find a half-way decent job afterwards—but it's too big for me, and I've got other things to do. However, perhaps the people down at Vocations for Social Change might be into it.

Randy Chakerian
Seattle, Wash.

Knife

Out in the woods you'll have use for a good knife. If you want the genuine humdinger of 'em all write to the Randall Co. Orlando, Fla.. These knives are all handmade without a die. You might have to wait a while to get it and can easily spend \$35—up. I have the model No. 3 with a 6" blade.

If you don't want to spend that much, Buck makes some good hunting knives and a fine folding knife for \$18. Lower in price still is the Case folding hunter for \$8.

A tip to you northern grain eaters who may be spending your first hard winter. It's hard to make it in cold climes without meat protein. So if your feeling poorly try some meat. It's a life cycle too.

Bill Wolf
Ft. Lauderdale, Fla.

We're looking for a negative ion generator.
Anybody know where we can get one?

From Earth's First Groupie

One of the best books I know of for facts about this total place (and all its parts phenomena) is the *Larousse Encyclopedia of the Earth*. It is a basic book of explanations—like an Earth Bible—with beautiful illustrations—that belongs in your catalog because it belongs in people's awareness.

It's not a book for scientists mind you, but it's a book I hug.

Yours truly,
Karen Korell
New York, N. Y.

12

Cultural Stuff

THE OXFORD UNIVERSAL DICTIONARY (now called "the Shorter OED" which it isn't)

the full history of words in English or full enough lots more words than the multi-volume OED the only historical dictionary great quotes useful for every purpose it doesn't tell you what to do it tells you what has been done no proper names (not a half-assed encyclopedia) records U.S. variants & genuine American words no attempt to list every word that has ever appeared gives you the whole idea behind a word (meanings inhere in words whether or not they are consciously current) good brief etymologies (drawback: familiarity with Latin assumed) dates various usages does not imitate or replace other dictionaries indispensable for word freaks (Suggest reproduce articles for Whole, Earth, Catalogue)

THE FOUNDATIONS OF MODERN ART by Amadee Ozenfant (1928) paperback Dover

strange & personal book a groove of visual resources despite unfashionability of Art, great book by a friend of Jeanneret (Le Corbusier) funny, snappy dialogue (Suggest reproduce a horse being shown a portrait of itself—illus.)

Suggestion for a new section of your book ANNALS OF CIVILIZATION

(you know you have no "history" stuff?) it is good to know what has been done so you don't have to do it yourself by hit-miss list great old books available from libraries (incomplete list) suggestions: The Memoirs of U.S. Grant (2 vols) The Story of the Revolution by Henry Cabot Lodge I The History of Art by Elie Faure 5 vols. The Classical Encyclopedia Britannica (1909—The British wrote down everything they knew then dissolved the empire & sold EB to Chicago).

LAROUSSE GASTRONOMIQUE in English

the history of the civilized use of food articles on all kinds of Western food & a little oriental full access to the secrets of the ultimate in Western cooking not for "the modern housewife" read about what you are eating at the dinner table! "It is very difficult to think about anything but food when eating." —Gertrude Stein

(Please include a word of caution about Rambauer-Becker next time: the instructions are over-simplified; the recipes are hodge-podge; there are a great many obvious errors in the use of the symbols & you have to refer all around in the book. Also, the OLD Fanny Farmer should be reprinted. Classical American cooking, for the faint-hearted)

HOW TO COOK A WOLF—by M.F.K. Fisher

A humanistic survival book for periods of shortage and extreme poverty (such as WWII in Europe) when it was written) in Western societies. Very funny & a little sexy. World—publisher, Cleveland. Still in print?? "To work! To work! for Heavens sake! The Wolf is at the door!"

(do you hate the French? You have hardly anything French in your whole thing. They are great.) [Yeah.]

THE PSYCHOANALYSIS OF FIRE by Gaston Bachelard the title is misleading to American audiences the meaning of alchemy in relation to modern science marvellous alchemical stories a little book with great implications

"The less we know about something, the more names we give it."

Beacon paperbacks. (This guy wrote books on Earth, Air, Fire & Water (2 vols.) only 1 trans.

Frederick Ted Castle
New York, N. Y.

Clear pictures

Myth in Art: a Huichol Depicts his Reality is incredible. Worth \$1.25 (?) from Latin American Center, UCLA. Full of fine color reproductions of the yarn paintings a north Mexican Peyote Tribe—Huichol—Shaman made to illustrate his people's myths & rituals & his visions. Also tells some of the myths & lore & how to make yarn paintings.

Bret Blosser
L.A., CA



Esalen Tapes

Much of the best of the Esalen Institute occasions (Baba Ram Dass, John Lilly, Fritz Perls, Joseph Campbell, Lancelot Law Whyte, Carl Rogers, etc.) are available by mail. Cost of the tapes is \$10/hr. Catalog is free from:

Big Sur Recordings
Big Sur, CA 93920



Foodarama plus

Food and Good food plays a great part in our lives. Sahadi Importing Co. Inc. (importers of the Tahini with which many are familiar) offer a catalog called The Silent Salesman which lists many many east asian, Turkish, Syrian goods: grains, sweets, nuts & seeds, olives, cheese, pickles, canned goods, dried vegetables, spices, water pipes, musical instruments, household items, furniture. Prices on spices is attractive but only handle large quantities. Service is not particularly fast to the west. Catalog is free. 187-189 Atlantic Ave. Brooklyn, N.Y. 11201 phone (212) MA-4-4550. Cable (SANACO)N.Y.

I am enclosing a price sheet from Sterling H. Nelson and Sons, Inc. [525 South 4th West, Salt Lake City, Utah 84110] They are the cheapest source of Brown Rice I have been able to discover. Also many other good items. I do not believe they are organic.

I have found a good source of seeds in R.H. Shumway Seedsman, Box 777, Rockford Illinois 61101. Though I do not believe they have organic seeds they have a huge selection. Sorry, no herbs.

For herb seeds, Greene Herb Gardens, Greene Rhode Island, 02827 have virtually every herb imaginable at 25¢/packet. Also books and pamphlets (most under 50¢) on how to grow and use them. I suspect they also have fresh herbs but do not know if they ship or whatever.

The Mildred Hatch Library, 8 Pine Street, St. Johnsbury, Vermont 05819 is the source for baking (and nutritional yeast. Baking yeast is 95¢/lb. + postage and the best we've ever used. They have a lending library "on Nutrition and Some other Essentials of Health" "Borrowed books may be kept for two weeks for cost of out going postage, repayable in stamps. Used books may be returned (with stamps to cover outgoing postage) for new ones if borrower wishes to buy them. There is no obligation to buy borrowed books, but postage is paid on those bought." They also have "books of special interest to gardeners and farmers" many of which are otherwise hard to find. And books on "Pregnancy, Birth, Breastfeeding and Child Development" Lists will be sent on request. They also carry mills, juicers, yogurt culture, etc., etc. Food people.

An excellent supplier of organic whole wheat is Ted A. Whitmer, Bloomfield, Montana 59315. They do not ship less than 100 lbs. Prices f.o.b. truck, Glendive, Mont. are:

100 lb. in poly-lined burlap bag	\$ 7.50
1000 lb. " " " " "	72.50
2000 lb. " " " " "	140.00

they have steel screw-cap cans for long storage also (40 lb. ea):

200 lbs	\$23
1000 lbs	\$112.50
2000 lbs	\$220.

They also grind flour (on order) at \$12.50 per 100 lbs but Walnut Acres carries the same (probably grind it themselves for \$15.86/100 lbs which would be cheaper for Eastern buyers, considering shipping. They also have smaller quantities.)

You do not mention in the catalog that Erewhon has a western outlet. They do. 8003 Beverly Blvd. Hollywood, Calif. Since their products are superior to and cheaper than Chico-san—this is the place for us in the west to purchase from.

Those wishing to get Chinese foods by mail and also certain utensils may obtain same from Cathay Food Products, Inc. 107 Mott St. New York, N. Y. 10013. Catalog sent on request.

Anyone working in graphic arts will appreciate Formatt's catalog of "Modern Multi-use Acetate Graphic Art Aids" containing "Letters-Arrows-Numbers-Rules-Borders-Symbols-Ornaments-Shading Mediums." for use in designing everything from money to maps. FORMATT from Graphic Products Corporations, 3810 Industrial Ave., Rolling Meadows, Ill. 60008

Eastern Silk Screeners may obtain anything serigraphic from Lambert Co., Inc. 920 Commonwealth Avenue. Boston Mass 02215 from paint to processing machinery. They maintain an excellent screen preparation service for serigraphers also. In addition they carry a complete line of art supplies. Catalog on request.

Those in pursuit of higher places will benefit from these 3 booklets "Fundamentals of Rock-climbing" published by the MIT Outing Club, Student Center, Room 490, Massachusetts Institute of Technology, Cambridge, Mass. 02139. This is a highly recommended short course from which anyone connected with the sport can benefit. It covers all the basic maneuvers, belaying, leading, ropehandling and accidents. A very useful book for anyone wishing to know what it's all about. Also available at the Ski Hut. \$1.00

Have discovered that the only sure way to waterproof boots is with beeswax. Melt the wax and stick a clean boot—preferably new—in the oven and heat it so its almost too hot to handle and retains its heat when taken from the oven. Rub the wax in with a clean cloth, putting the boot in the oven from time to time to keep the wax liquid. No wax should remain on the surface. A couple of times is sufficient. If you put too much wax in the boots will crack (especially when cold). No other waterproofing should be necessary for the rest of the season. Incidentally this method works well on both oil and chrome tanned leathers, though especially on oil-tanned goods (rarely found these days). The silicone waterproofing (such as Huberds Shoe Grease or Snow-Pruf) work better with chrome-tanned leather but beeswax is still superior, although it is best used with boots.

The boots are snakeproof in as much as most snakes cannot strike higher than the knee—which fact has been of inestimable value to me, several times preventing the extreme pain & anguish resulting from snakebite. They are called the Botte Sauvage and are available from Gokey, 21 West 5 Street, St. Paul., Minn. 55102

An extremely useful tool (which I am surprised you don't mention) and a very beautiful one—one of the best-engineered items put out by an American firm & available to consumers—is the Questar telescope. They now have 2 models. This is unquestionably the finest instrument of its type available today. Suggest you write to Questar, New Hope, Pennsylvania for complete info—it will astound you & everyone. They have a booklet for \$1.00 which is full of mind-blowing photographs.

Neil & Lorraine Wolf
Ketchum, Idaho

New Fuller Book

Utopia or Oblivion is a collection of talks and papers by Buckminster Fuller, made from 1964 to 1967. Some have been available in his World Design Science Decade Documents; four appear here for the first time. At \$1.25, it's bargain Fuller.

Utopia or Oblivion
R. Buckminster Fuller
1969; 363 pp.

\$1.25 postpaid

from:
Bantam Books, Inc.
271 Madison Avenue
New York, N.Y. 10016

or WHOLE EARTH CATALOG



Contents

<i>Introduction</i>	ix
1. A Citizen of the 21st Century Looks Back	1
2. The Music of the New Life	12
3. Prevailing Conditions in the Arts	80
4. Keynote Address at Vision 65	114
5. Summary Address at Vision 65	134
6. The World Game— How to Make the World Work	157
7. Geosocial Revolution	162
8. How to Maintain Man as a Success in Universe	207
9. Utopia or Oblivion	265
10. Curricula and the Design Initiative	293
11. Design Strategy	300
12. Epilogue	343
<i>Bibliography</i>	365

Hong Kong 1

I suggest: T.M. Chan and Company, P.O. Box 3881, Hong Kong Catalog available free—allow about 5 weeks. delivery by sea-mail.

If you want a high quality Japanese camera, and don't plan to go to Vietnam in the near future you can save a lot of money by mail ordering from Chan in Hong Kong. Most good Japanese cameras, lenses, and accessories are available including Canon, Nikon, Minolta, Pentax, Olympus, etc.. All are first quality items and Chan guarantees what he sells and is completely honest. All prices are post paid (sea mail takes about 5 wks) but for an additional \$3 per lb. (about \$10 for a camera) air mail will get it to you in about 2 wks.

Hong Kong is absolutely duty free and therefore prices on luxury items like cameras, tape recorders, etc. are very low, but shipping costs to the U.S. are high, so the lighter an item is, the better relative price. Chan sells Sony tape recorders and radios, but because of their weight the savings are small. The best deals are cameras, lenses, electronic flash units, binoculars, and exposure meters.

One of the best deals from Chan is the Canon FT-QL slr camera with f1.8 lens. In U.S. stores it sells for about \$280 with case, but is available from Chan for \$118. Nikon F with f2.0 lens is about \$180.

WARNING: Do not buy a Pentax camera abroad. Honeywell, the U.S. distributor will screw you for a \$90 minimum repair fee should it ever get sent in to their shop.

When a camera arrives from Chan an import duty is collected by the post office. This runs about \$15 on the Canon ft-ql and about \$22 on the Nikon. Also, due to import restrictions, the brand name on the camera will be painted over in black lacquer—this can be removed with nail polish remover.

When ordering from Chan, pay by cashiers check. The company motto is "Honesty and Service" and they live up to it. Also, the stamps on their letters are nothing short of neat.

Thomas Dixon
Iowa City, Iowa

Farmless Harvest

1. Euell Gibbons — *Stalking series*. \$7.50 each (I hear it's gone up. Hardback only. These are the best and have the most accurate recipes and most interesting reading by far. But there are others with other information which shouldn't be overlooked.
2. Fernald, Kinsey, Rollins — *Edible Wild Plants of Eastern North America*. Expensive. Harper and Row, New York. Hardback. This has the broadest scope and includes most edible plants. I check this first to see if the plant I have is edible then look in others for recipes or further lore. It has a good section on poisonous plants that look good enough to eat.
3. Nelson Coon — *Using Wayside Plants* \$3.95 and *Using Plants for Healing* \$4.95. both Hardback, both by Hearthsides Press Inc., 381 Park Ave. South, New York 10016. The first, besides food and recipes (limited) mentions dyes, toys and arts and crafts made from easily procurable plants. He should be checked out by anyone really interested in plants.
4. Ben Charles Harris — *Eat the Weeds, Kitchen Medicines* \$3.00 and *Better Health with Culinary Herbs*. Paperbacks. Natura Publications, 237 May St., Worcester, Mass. *Eat the Weeds* is out of print, but worth hunting for in second-hand stores or libraries. *Better Health* etc. . . I haven't seen a copy yet. Harris is a Health Food Nut and a registered pharmacist. *Kitchen Medicines* has lots of detailed recipes for all kinds of home remedies made from usual foods like grapefruit, garlic, honey and vinegar. He also lists antidotes for poisons. It's worth having.
5. Joseph E. Meyer — *The Herbalist* \$4.50. Hardback. I got this at Meadowbrook Herb Garden, Wyoming, Rhode Island 02898 and you can order it through them. You can also get their catalog for 25¢. They say "minimum order \$3.00, add 50¢ postage west of Mississippi." They also added R.I. sales tax onto the bill. *The Herbalist* comes from England, but many old English medicinal herbs were brought to this country and are now found wild in abundance here. Check Latin names with a U.S. type herbal, as common names are apt to be confusing from one area to another. This includes medicines, dyes, cosmetics, vitamins and minerals, potpourri, good luck charms, love potions and other odds and ends. While Gibbons and Coon are more interesting to read, this produces more information in a smaller space. Some of it, however, may only be useful in England or Europe.
6. Foulsham — *Culpeper's Complete Herbal* \$5.95. Published in England, Sterling Publishing Co., Inc., 419 Park Ave. South, New York 10016 distributes it. Or you can order it through Meadowbrook Herb Garden as mentioned above. Nicholas Culpeper died in 1654. Since then the benefits of some of his herbs have been "proven" and others have been discredited. It's not hard to get along without this one, but if your bag is herbs, it's a useful historical reference.
7. Oliver Perry Medsger — *Edible Wild Plants*, Macmillan Co. 1939. is also good, but covers the same general area as Coon, Gibbons, Fernald etc. I don't know if it's still in print.
8. Edwin Rollin Spenser — *Just Weeds*. Charles Scribner & Sons 1940, N.Y. Mostly he tells how to get rid of unwanted species, but he also mentions their virtues. Good illustrations. This is a good identification book as he sorts things according to lay concerns. ie. grasslike or not grasslike. These last two I've used only in the libraries in hardcover.

There are two more I've heard are good, but have been unable to get hold of so far: *Folk Medicine* by Dr. Jarvis and *The Nature Doctor* by Dr. Vogel. Of course there are many more—check your local library—but these are the ones I've found most helpful, and they are listed in the order of their importance to me. For westerners, try *Useful Wild Plants of United States and Canada* by Charles Francis Saunders. Robert M. McBride & Co. 1926. I don't know its cost, and it may be out of print, but most of the others seem to concentrate mainly on the East coast.

I'd like to see information on how to make cheses, other than cottage cheese and on where to get any necessary equipment. I mean for family or community use, not commercially. Or is this impractical? Also yogurt . . . can it be made with raw milk from Gurnsey (high butterfat content) cows? Can it be done without an electric yogurt maker?

Servel no longer makes Gas refrigerators, though it will continue to service old ones. Is there any company that does make them? What about Gas freezers? [Check trailer suppliers.]

Jacki Roth
Cambridge, Mass

Food preserving

For your book list— "Complete Book of Pickles & Relishes" by Levinson—has all you could want to know of pickling—even olives! Costs \$6. Also Farm Journal's "Freezing & Canning Cookbook" is complete for all methods—down to how to smoke meats & fish. Anyone cold learn food preservation in total by studying this. Costs only \$2.95.

Mariel Dewey
Gilroy, California

Hong Kong 2

Far East Company, PO Box 6784, Kowloon, Hong Kong. Stephen Woo, manager. Source for photographic equipment, tape recorders, hi-fi stuff, projectors, etc at considerable savings. The best savings are of course on the Japanese-made things, for example, last year I bought a Pentax Spotmatic with an f 2.8 105mm lens with case, body cap, etc all of which would have sold on this side at about \$320. Cost from Hong Kong: \$153 post paid by sea plus duty. Honest and dependable, one order yields at least a couple of delightful letters from Mr. Woo in pidgin English. Some brand names are protected in the US, Honeywell has rights to "Pentax" and "Takumar" and if the customs people catch it all you have to do is remove the marks from the equipment.

Jas Hayden
Tempe, Arizona

Cosmofoodarama

Would you be interested in having a series of specialty cookbooks reviewed? What I have in mind are cookbooks that deal with important but inadequately understood foods such as soybeans, seaweed, mosses etc. and cookbooks which are imaginative in their use of grains and lentils, yogurt, vegetables. For example, I think it would be very worthwhile to review the best vegetarian cookbooks (to be distinguished from vegetable cookbooks). I once saw a superb vegetarian cookbook put out by the Seventh Day Adventists and I think it would be worth tracking it down. What follows is a list of titles which should be investigated and the best ones reviewed for *Whole Earth*. I will mark with * those titles which I have heard of but not seen. I have not checked to make sure these titles do not already appear in your catalogue.

Gundy Jones, Dorothea Van. *The Soybean Cookbook* (New York, Arc Books Inc., 219 Park Ave., South, New York, 10003; 1968) \$1.45; No. 1440

*Jones, M.L. *Better Soybean Recipes* (Outdoor Picture Publisher) \$1.95

*Smetinoff, O. *Yogurt Cookbook* \$1.98

*Gordon, A.A. *Venison Book: How to Dress, Cut up and Cook your Deer* Greene Publisher, \$1.95

*Sherry, K. *Specialty Cuts and How to Use them* C.E. Tuttle Publisher, \$2.25

Thompson, Edna. *Yoga Cookbook* (New York, distributed by Book Sales Inc., New York 10, N. Y. Philosophical Library, Inc. No. WL46. 15 East 40th Street, New York 16. 1959) About \$1.65/ also in Paperback Library No. 64-012 \$7.5

Roberts, Susan and Yogi Vithaldas. *The Yogi Cookbook* (New York, Pyramid Books, 444 Madison Ave., New York 10022: 1968) \$.75 T-1900

*Banks, J.E. *Alfred Packer's Wilderness Cookbook* (Filter Publisher), \$1.00

*Porsild, A.E. *Emergency Food in Arctic Canada* (National Museum of Canada, Special Contributions No. 45-1, 1945)

*Porsild, A.E. *Edible Roots and Berries of Northern Canada* (National Museum of Canada, Miscellaneous No. 8, 1937)

Groves, J. Walton. *Mushroom Collecting for Beginners* (Canada Department of Agriculture, Publication 861, June 1958) \$.35 (30 pages) very good.

*Groves, J. Walton. *Edible and Poisonous Mushrooms of Canada* (Queen's Printer, Department of Public Printing and Stationery, Ottawa, Ontario) contains 30 color plates and 75 photographs in black and white, \$7.75.

"Zen Cookery: Practical Macrobiotics," *The Philosophy of Oriental Culture, vol. 1* (The Ohsawa Foundation, Inc., Ignoramus Press, Ohsawa Foundation, Inc., 1434 North Curson Ave., Los Angeles, CA: .966) \$3.00. There are several other related volumes.

For seaweed recipes:

*Griffin, S. *Japanese Food and Cooking* (C.E. Tuttle Publ.) \$1.50

*Nicholas, T.W. *Pleasures of Japanese Cooking* (Cornerstone Publ.) \$1.45

*Dakota Farmer's *Help One Another Cook Book*. (North Plains Publ.) \$1.00

El Molino Best Recipes: (El Molino Mills, 3060 W. Valley Blvd., Alhambra, California) \$1.00 but only 50¢ if you send in a label from a package of El Molino Yeast.

Soyer, Alexis. *Soyer's Cookery Book* (original title: A Shilling Cookery for the People embracing an entirely new system of plain cookery and domestic economy) New York: David McKay Company Inc. 1959, reprinted from the mid nineteenth century edition. \$2.50 hardcover. a gem.

McNeill, F. Marian. *The Scots Kitchen: its traditions and lore with old time recipes* (London: Blackie and Son Ltd., 1959) about \$3.50 hardcover. This is a superb book containing lots of folklore and excellent recipes for nettles, seaweed, dulse, oats, barley and other types of peasant fare, all authentic.

*Sheridan, M. *Art of Irish Cooking* (Medallion, Berkeley Publ. No. 1337) Other Irish cookbooks I have seen have lots of recipes for carageen moss.

*Richmond, S. *International Vegetarian Cookery* (Arco Publ. Co. Inc., 219 Park Ave. S., New York 10003) \$1.75

Braue, John Rahn. *Uncle John's Original Bread Book* (Pyramid Books, 444 Madison Ave., New York, 10022) \$.95. This is an outstanding bread book, one of the very best I have seen at any price. N-2045

*Keyes, Margaret and Ancel. *The Benevolent Bean* \$3.95

*Orton, Vrest. *Cooking with Whole Grains* \$2.50

*Toms, Agnes. *Eat Drink and be Healthy* \$5.95

**Sourdough Jack's Cookery* \$1.50

*Carlin, Gail. *Today's Manna* (a vegetarian cookbook) \$2.75

Bravery, H.E. *Successful Wine Making at Home* (Arc Books, 219 Park Avenue South, New York, N.Y. 10003) \$95 (1967) No. 861

Bravery, H.E. *Home Brewing without Failures* (Arc Books, etc. 1966) \$95 No. 1436

Roate, Mettja C. *How to Make Wine in your own kitchen* (Macfadden Books, Macfadden-Bartell Corporation, 205 East 42nd Street, New York 17, N. Y., 1963) \$60 No 60-135

Favourite Breads from Rose Lane Farm (a very good bread book) hardcover

*Bromfield, Louis. *The Farm* (organic farming approach)

*Bennett, Victor. *The Complete Bean Cookbook* (Prentice Hall, \$5.95) hardcover . . .

There are some other titles worth mentioning.

Tilke, Max. *Costume Patterns and Designs: A Survey of costume patterns and designs of all periods and nations from antiquity to modern times*. (London: A Zwemmer Ltd. Publ.: 1956) 128 pages of plates, 112 of which are in full color. big format. about \$18.00. and worth every penny. The pictures are set up so that you can see how things are constructed and then make the costumes yourself. You have to see it to believe it. The best book of traditional (primarily non-western) costume I have ever seen.

(Mrs.) Barbara Kirshenblatt-Gimblett
Indiana University Folklore Institute
Bloomington, Indiana

Kelly Yeaton Suggests

Suggestions:

Whole systems . . . How did you ever miss L.L. Whyte's THE NEXT DEVELOPMENT IN MAN? Or did you figure that his thought is incorporated in Koestler and others? Would you care for more data? Its now a Harper paperback.

Theater . . . you probably wouldn't know ROY MITCHELL'S CREATIVE THEATRE recently republished in paper and cloth on 300 year bond by an admirer and available only through the Drama Book Shop, 150 West 52nd, NYC at present. I wrote the foreword but it is a non-profit publication for us all. I'll enclose some quotes. Of all the theatre literature I know, it is the only book that seems to me to comprise a whole system as it was then, and much of it can never change. Perhaps too specialized a matter, but it does deal with the theater as an exercise and art of community, with its source in the ancient mysteries. I've found it trustworthy for 40 years, but it doesn't mean it will work for everybody, of course.

Craft Your sources are fine, but where the hell is your philosophy? I'll enclose a leaflet by Mary Caroline Richards whose book on CENTERING I am not competent to review for you. Listen to her voice and you'll realize that something is missing in your list.

Is Lester Griswold's 1952 HANDICRAFT out-of-print? If not, it belongs in your list, as one of the most extensive craft works. Prentice-Hall.

LIGHT There is a lot of conning in the Light Show business and a lot of snow jobs going on, but BOB BECK'S Light Show Manual (Pericles Press, 1540 Cassil Place, Los Angeles 90028) was a good honest compilation of most of the best material I have ever seen in one place. Yet, I am not an expert. But you ought to check to see if he is still publishing it. I had trouble getting my copy a few years ago. It was the 3rd Edition.

WINE You're good on bread, but what about some help for the winemakers? Presque Isle Wine Cellars in Erie and WINE-ART in Ontario publish and supply stuff with much intelligence. Perhaps everyone in California knows all they want to know, but Presque Isle is a professional supplier of juice and supplies for the amateur winemaker. Very nice people to deal with. More white wines than red, of course. Can't ship juice, though. So people make annual pilgrimages to Erie to pick up their juice for the year and socialize. Come from Ohio, Ncw England, West Virginia, etc.

I know Herters has stuff but he is just as sloppy in that area as in many others.

One other invaluable handbook although it costs too much is

Viola Spolin's IMPROVISATION FOR THE THEATRE

It is the primary source and literal handbook for the "new theatre" that isn't just Happenings and Sensitivity stuff. Goes under bringing up children, and communications as well. Blends right into a lot of the Esalen training like SENSE RELAXATION.

Kelly Yeaton
State College, Penna.

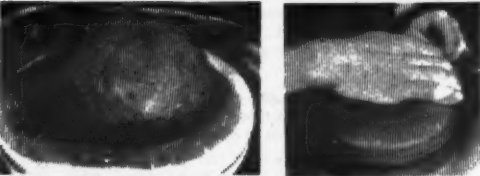

I didn't want outlets for my energy, I wanted inlets. It was hard because the propaganda was all toward making me think of myself as a verbal intellectual type, though I instinctively knew that this was a small part of the picture. I have been trying to work toward a true idea of the whole picture, and that is what my book Centering is about. It turns out it is not so much a picture as an evolving life-line. The vine.

The lie that teachers are not artists puzzled me. All sharp divisions puzzled me, and rivalries. I was not a good fighter. I used to think it wasn't nice to fight. Now I know we have to fight for our lives all the time. Usually the fight is an inner struggle with dragons and cloud-castles, but never mind about that. The point is, we suffer by being told by others what we are supposed to be like. Either what we are like, or what we should be like. It is very hard to survive as a person with all this pressure on us. It calls for heroism.

We have to keep saying *no that's not quite the way it is*. It is very hard to keep saying *no* and *yes* at the same time. *NO* to what's false and *YES* to the dialogue. There was a wonderful woman at Black Mountain College where I worked for several years. She was Viennese and she taught music. Her name was Johanna Jalowetz and she had an expression which I think should be taught in the schools as fundamental to life. She used to say it all the time, *no-ja, no-ja, NO-JA*.

M. C. Richards

The central images in the book are taken from the potter's craft: centering, and the *ordeal by fire*. But both are archetypal and occur in other contexts as well. Centering is a term used by the Quakers for a feeling of flowing toward a common center in their meeting for worship. It is also an ancient Sanskrit term used in spiritual disciplines of the east. What it means, I think, is to feel the whole in every part. When you center clay on the potter's wheel, you take a lump of clay, and by moving it upwards into a cone and outwards into a plane, you create a condition of balance between the outside and the inside, so that when you touch the clay at a single point the whole mass is affected. Centering has nothing to do with a center as a place. It has to do with bringing the totality of the clay into an un wobbling pivot, the equilibrium distributed throughout in an even grain. The substance of the clay has to be brought to a condition of stillness at the same time that it is spinning, it has to be worked so that there is no difference in quality between the surface and the interior, a balance between the inner consistency and influences from without. So that when we stick our fingers into it to open it up into a vessel, the inside will be as firm and malleable as the outside, and will be able to create a space which will be a container. It is poetic and mysterious and yet very actual and concrete and messy and common clay. **COMMON CLAY! WHAT'S THAT?**

M.C. Richards
From: Penn State Papers
in Art Education

14

Bulk Film

I suggest Superior Bulk Film Co.
442-450 N. Wells St.
Chicago, Ill. 60610

A reliable mail order service (& store) for 8 mm & 16 mm film, processing, equipment for home processing labs, & most equipment & supplies for amateur filmmakers who desire control & versatility at low-cost. Their film & processing package deals are as cheap or cheaper than any I've seen, probably more reliable than most. Also have excellent specials frequently. Discontinued film stocks, spliced reels, etc.—check it out! Good catalog available, newsheets rundown specials, new stuff, changes, etc.—write to Superior. I'd be glad to organize a more coherent review if you're interested. This place isn't one of these Jumbo-Junk Filmailer houses. I first got turned on to them by a recognized experimentalist, now teaching at state university.

Bruce Schmiechen
Chicago, Ill.

Afrasia

Afrasian Markets—Buyers Guide
41 Hamam St. P. Box 325 Bombay 1, India
One year's subscription—8.00 postal order—

This is one to check out—my memory is fragmented these days but I remembered it as a groovy source—everything from hemp to nuts—Beware, bad delivery from India!

The Catalog needs information for Canadian mutants—i.e. will the Co. mail goods to Canada, accept Canadian \$, etc. We badly need a Canadian branch—source of supplies within the country—for example—the Ashley stove comes from B.C.

Jack Wise
Estepona, Malaga, Spain

We'd love to see a Catalog for Canadians. It won't happen until some Canadian starts one. We can suggest to this entrepreneur that from our experience he's got a hungry market waiting.

Boat

Jay Baldwin says these Boston Whalers are known as the best of the new small utility outboards. \$595-\$2045. Suitable for ocean use.

from:
The Fisher-Pierce Co., Inc.
1149 Hingham Street
Rockland, Mass. 02370

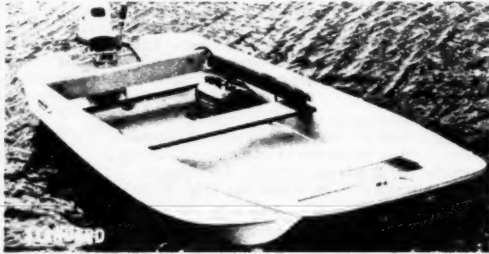

Little Car

Despite the hokey name the King Midget is a really fine runabout car. A one cylinder engine and 12 horsepower make for 60 miles to a gallon with an automatic transmission. Only one model is offered, a two seat convertible for \$1,095.

I operate mine for 75¢ a week in daily stop and go traffic.

—one warning, this car is not for expressway use, but its great to run down to the local market.

James J. Berryhill
Atlanta, Ga.

available from:
Midget Motors Corporation
Athens, Ohio 45701

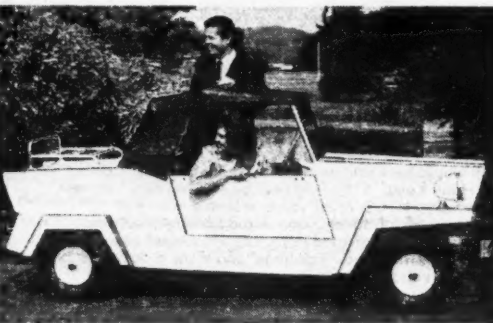

Architects and Hot Water

Charrette Corporation of 2000 Massachusetts Avenue,
Cambridge, Mass.

Describes itself as "EVERYTHING The Architect Needs For Drafting Design, Presentation, & Model Making."

CATALOG on request. From my experience they have the finest quality, are reliable, good prices on all items, overwhelming volume of stuff in stock. They were set up about 5 years ago to fill a need, bringing drafting and architectural supplies and technology up-to-date. When you see their store you know they have done it.

Landam Corporation, 2211 Broadway, NY, NY 10024

makes and sells a hot water heater that plugs into the pipe very simply, and heats your water as it runs out. There's

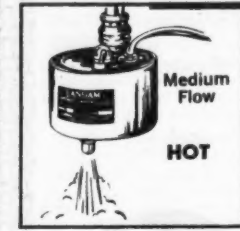

a limit to its total effectiveness, as far as total volume goes, but for a campsite, or house, or trailer living, it does a grand job. It weighs less than two pounds, needs electricity, and costs about \$35.

T. H. Neel
Cambridge, Mass.

What's a Tesla Motor?

I am told that one may get plans to build a Tesla Motor for \$3 from Fan Industries, Box 7544 St. Paul Minn.

A Tesla motor is supposedly super-efficient and can change directions almost instantly & lasts just about forever with no maintenance. I've not seen one or read up on it myself & don't know how true these claims are, but perhaps you would like to investigate it.

Mal²
Office of my high reverence
Malaclypse the Younger KSC
OPOVIG High Priest POEE

Non-skid moccasin

In the last issue of the Catalogue you listed some good moccasins and in the review I mentioned that the way to tell good moccasins from bad is whether or not stitching is visible in the seam that joins the upper portion of the moccasin from the lower. It also mentioned that those moccasins were sudden death on wet surfaces such as wood or smooth concrete. Fairchild Indiancraft, at 11750 Victory Blvd., N. Hollywood, Calif., makes superb moccasins with beautiful invisible stitching, and they offer a nice solution to the sudden death problem in the form of optional, thin, textured, composite soles. I have had a pair of moccasins with these soles for more than a year now, and they are the finest things I have ever put on my feet. The soles are thin enough to give you an acceptable "barefoot" feeling, and allow you to be suitably aware of the ground beneath your feet, but are thick enough to allow walking or jumping about on sharp rocks such as those native to most of the California coast. Although no moccasin is really good for your feet during prolonged pavement-type walking, these are surely the best of the lot.

Briefly, here are other relevant facts about the product:

- Fairchild Indiancraft offers a basic model, 7" high, boot-type moccasin. The seams are impervious to all stress and weather, and there are no openings of any sort below the very top of the moccasin. The leather lacing is made from the same leather as the moccasin. Buyer must sent in tracings of each foot, and specify rough-out or smooth-out. The man in the store suggests, and my experience tends to bear him out, that rough-out seems to be more water repellent than smooth-out.
- The standard model comes with a 2-3" piece of fringe down the middle of the foot below the lacing, which many people seem to prefer not to have.
- The store will modify the basic design in any way that can be described coherently to them. The basic model cost about \$22, including surface postage, when I bought mine, but recent prices should be checked. Higher moccasins cost a good deal more, as does the addition of special fringe, etc.
- On its wall, the store has letters from Alaska from customers who have used this footwear extensively in snow and ice.
- The store will re-sole and repair their product at a reasonable fee.

John Cooke
San Francisco, CA

Library-College

Have you heard of the LIBRARY-COLLEGE movement? See book of same title edited by Louis Shores, Robert Jordan, John Harvey. Drexel University Press, 1966. Also article LIBRARY-COLLEGE USA by Louis Shores in ALA BULLETIN, Dec. 1969, p. 1547. Stretch those ideas to pre-kindergartens and elementary schools & we've got it made. Built-in crap detectors and truth-finders.

Bill Hinchliff
Washington, DC

Make a Boat

Having grown up on an island, the ocean is the main thing around here and we are heavily involved in boats and similar marine environmental controls.

The best books on boat design & construction I have yet found are by Howard I. Chapelle and of these, *Yacht Designing and Planning*, *Boat Building*, and *American Small Sailing Craft* are the most significant & useful—his other books are fascinating but mostly concern bigger ships & history—all are beautifully illustrated—Chapelle has got to be the worlds best draftsman—and his writing is alive and entertaining and therefor incredibly educational.
W. W. Norton & Co. New York, N.Y.

Materials: Fiberglass & polyester resin is now cheaper than wood for boats in Hawaii & probably elsewhere. We are using thin wood forms with heavy glass skins for 1-off designs now & fiberglass turns out to be maybe twice as costly as ferrocement but easier & more dependable—Quality control with F.C. is very difficult and if you screw up its all over.

Ocean People & Polynesian Boats: A loose group of people who dig on the ocean & are into boats & oceanic things. We are into Polynesian Boats a lot as they are a real dymaxon approach to the marine environment—a 20' proa built last year cost \$200.00 including sail & paddles. It carries 6 people & could be lived on by a couple. Our standard boat is a 16' outrigger canoe which is fiberglass, weighs 120 lbs & carries 3 people. We have surfed them in 6' surf & haven't broken one yet. We sell 'em for \$250.00—\$350 for sailing version. We haven't sold a lot, but they keep body & soul together. At any rate, I think people who mess with the ocean should look into the Polynesian concept as the most efficient approach to the ocean as canoes-outriggers, cats & tris can be made really easily & cheaply & are very seaworthy and can be very fast indeed. Anyone interested in this can contact me & I will try to turn them on to the max boat for min.\$.

Hunt Evans Johnsen
Ocean People
69 Palimalu Drive
Honolulu, Hawaii 96817

Outdoor stuff

Eastern Mountain Sports Inc.
1041 Commonwealth Ave.
Boston, Mass. 02215

Their catalog (FREE) is a veritable Consumer Reports of camping equipment. It features a table of specific details for stoves (including boiling time for one quart tap water), Table of Specific Details for sleeping bags (including inches of loft), Specific Details of cubic volume of Stuff sacks (clarifies the entire matter of comparing different brands & sizes in one simple table), Tables of Spec. Det. of Tents, Packs, Packframes, etc. This catalog is a must no matter who you buy from. They also rent equipment, give advice, and run a mountain climbing school!

Surely you know the Sierra Club Wilderness Handbook Edited by: David Brower. A Sierra Club—Ballantine Book 95¢ Originally intended as a handbook for those planning a Sierra Club Trip, this is a fine, keep it simple, camping book which includes the only sensibly written chapter on the special problems faced by women on camping trips, a good chapter on taking the children, and a seemingly endless (but I'm sure expert) chapter on burro management. This one is not for car campers.

While we are still outdoors there is the Brooklyn Botanic Garden, 1000 Wash. Ave. Brooklyn, NY 11225 They have about 40 handbooks, shiney paper, good photos, 64-112 pages, \$1.00-1.25. Included are handbooks on Herbs, Biological Control of Plant Pests, Dye plants & Dyeing, there are new ones coming out all the time and they must have some sort of descriptive list available—there is one on the back of each handbook.

As a transition from outdoors to indoors HOW COULD YOU LEAVE OUT THE SUNSET BOOKS? They are chock full of lots of well explained and illustrated information—right now all of Cambridge has gone wild over the Sunset Cookbook of Breads. \$1.95 Lane Magazine & Book Co, Menlo Pk, Cal 94025

Herbs for every Garden; Gertrude B. Foster E.P. Dutton & Co., Inc. N.Y. \$4.95

Mrs Foster is editor, along with Mr. Foster, of the Herb Grower Magazine (5.00 a year order from Falls Village, Connecticut) a sort of continuing conversation between friends about herbs. The book is a marvelous reference work on how to grow just about any herb. Each listing is divided into: height, Leaf & Blossom, habitat, culture and uses. Mrs Foster has grown all these herbs and she knows what she is writing about. Subscribers to the mag. (a quarterly) are allowed to send problems and questions to her and to visit her garden of over 250 species of herbs.

Sears & Roebuck Co sells, through the catalog, work denim in dark blue. 38" wide, 87" a yard. You might mention how hard it is to get them to give you a catalog the first time.

The Appalachian Trail! a continuous marked path—for foot travel—through the mountain wilderness of the Eastern Atlantic States. It's over 2000 miles. The Appalachian Trail Conference, 1718 N St. N.W. Wash. DC 20036 has a publication No. 17 that tells about the trail and lists the guides and maps that are available from them and their affiliated organizations. Since they have a limited volunteer staff they don't like individual inquiries—they claim they have answered all your questions in their booklets so write for Pub. 17 before you go asking them questions.

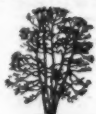

Rachel Kopel
Cambridge, Mass.

Ranch duds

May I suggest:
Western Ranchman & Outfitters (catalog)
210 W. 16 Street
Cheyenne, Wyoming 82001

Everything from Levis & cowboy boots to dress up satin cowboy shirts and square-dance dresses.

Nancy Dine
London, England

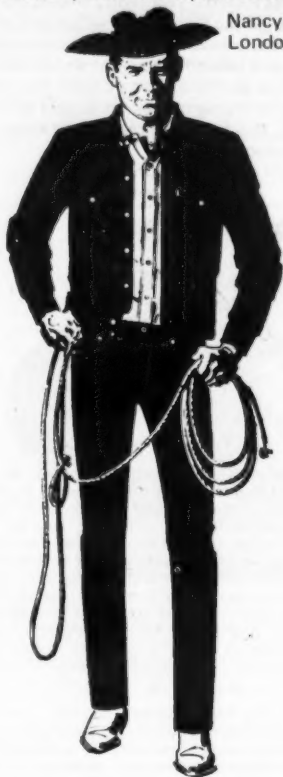

Scuba supplies

Skin diving (with mask, snorkel, fins, etc.) and/or scuba diving (with tanks of air) are healthy recreation which allow one to see and enter a completely different world where he is surrounded by a different medium (water) and different flora and fauna from those which he has experienced in his lifetime.

I have found the best place to buy equipment on the east coast, and I think the west coast. It is New England Divers Inc., Beverly, Mass. They are the distributors of diving equipment to the eastern sports shops and will sell to individuals, in small or large quantity, all brands of diving equipment at the same price that they sell it to the sports shops. They sell over their counter, by mail, or by phone (one can call collect from anywhere in the continental U.S. for an order over \$50.).

The "salesmen" in the store are all extremely experienced professional divers. They have given me knowledgeable and honest advice with their low prices. Last spring I was preparing to go to Turkey on a deep diving underwater archeological expedition sponsored by the National Geographic Society.

When I went to their shop to discuss some personal equipment purchases with them I found they already knew about the expedition and what kind of work I'd be doing. They brought up and discussed with me the pro's and con's of various equipment, convincing me not to buy some items and to buy some others. When I was in Turkey this summer, isolated from any diving shop, I found they had been right in every detail.

One of the things I bought was a U.S. Divers Calypso "J" regulator which can be purchased in any sports shop at \$110. These people sell it for \$73.70, brand new, with guarantee (this is one of the most expensive but also the most reliable regulator).

Warren Riess
Norwich, Conn.

Water Purifier

MAKES CRYSTAL CLEAR, DISTILLED WATER FROM

Sea Water
Lake and Stream Water
Hard Water

Contaminated Water
REMOVES ALL SOLID IMPURITIES

AS EASY TO OPERATE AS A COFFEE POT

NO FILTERS TO CHANGE

STARTS UP IN FIVE MINUTES

COMPLETELY SAFE

MAKES UP TO 2 QUARTS OF PURE WATER EVERY HOUR

USES HEAT FROM ANY SOURCE

Camp Stove
Sports Stove
Camp Lantern
Gas or Electric Range
Campfire (bed of coals)
Laboratory Burner

The QUENCH Water De-Salter/Purifier supplies fresh water wherever you are. All that's needed is a source of water; any water, and a source of concentrated heat; any heat. The QUENCH De-Salter delivers up to two quarts of fresh, clear, salt and mineral free, distilled water every hour for as little as 1¢ per quart.

Cost: \$100.

Terraqua Marketing Division
Exri International, Inc.
1660 11th Street
Denver, Colorado 80204 U.S.A.

Neoprene snowshoe binding

I thought you might be interested in my business making snowshoe bindings, so I'm enclosing a circular describing it and a sample of the material. It isn't clear to me whether I as the manufacturer of the item am entitled to review it for the Catalog, but in any case I have done so.

Best wishes,

Bruce Beck
Beck Outdoor Projects
RFD No. 1
Franklin, N.H. 03235



REGULAR MODEL makes use of the design used widely over this continent by trappers, lumberjacks, and real outdoorsmen—men who sometimes must be on snowshoes 25 hours a day. We have replaced their leather straps with neoprene-nylon, which lasts longer and doesn't stretch. We have added riveted tabs for adjustability in the arch area, and special length-adjusters where heel straps attach to snowshoe crossbar. Three buckles per shoe (heel strap buckle shown in photo No.2). All ends pointed, all holes punched clean. Standard size shown, the first item on page 1 list. 7.00 ppd.

Ballooning

There's a magazine for balloonists:

Ballooning
Deke Sonnichsen, ed.

\$2/ yr, quarterly (\$3 foreign)

from:
Ballooning
Menlo Oaks Balloon Field
Menlo Oaks, CA 94025

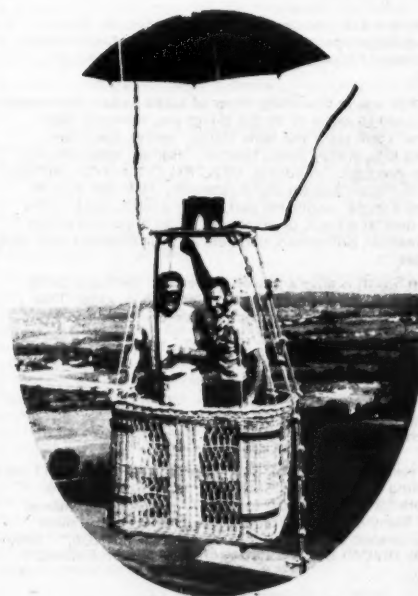

Seafaring Sauna

Several additions to your books on knots and sailing: (all of these are published by Brown, Son & Ferguson, Ltd. 52 Darnley Street, Glasgow, S.1. Costs are post-paid in USA) *Marline-spike Seamanship* by Leonard Pople is the classic text on wire-rope splicing. While he is more concerned with 1-inch diameter cable, I've used his technique on the 3/8 in. halyards on my sailboat. Since professional splicing is about four dollars per, there's more than just snob appeal involved, especially since the book costs \$1.30. His other book, *Advanced Ropeworking* (\$.80) discusses splicing large hemp rope, making fenders, etc. and is most valuable as a discussion of tools and techniques, rather than as a cookbook. Three books by Blandford (see p.57 of the Spring Catalog): *Rope Splicing* (.75), *Working in Canvas* (1.00), and *Netmaking* (86¢) are all well worth their prices. The latter two should be quite valuable to any tent-living commune that either plays tennis or poaches. A friend of mine who sailed on a five-masted bark, *Antara*, mentioned that the ship was completely re-rigged recently. As an "instruction book" they used Harold Underhill's *Masting and Rigging the Clipper Ship and Ocean Carrier*. He used the book to re-rig a Baltic Galeas (schooner with mainsail aft). Along with several other books by Underhill, These are excellent introductions to how these sailing ships "worked". (It costs \$8.62) Their catalog "N" is free. Do you want fuller reviews on any of these?

I would complete your books on photography with Ansel Adams's five books. They're at least 20 years old, but not dated at all. The *Photographic Exposure Guide* published by USA Standards Institute, 10 E 40th St, New York 10016 for about \$2-2.50 is chock full of tables for every possible exposure situation. Excellent for things like sunsets, the moon, fireworks, etc.

Your mathematics books should be completed by Polya's *How to Solve It*, which used to be available in paperback for about two dollars. His other two books are much deeper (but not impossible). I would also recommend *Mathematical Ideas in Biology* by J. Maynard Smith as reviewed recently in Scientific American. It costs twelve shillings in paper in England.

Books are much cheaper in England. I saw the *Ashley Book of Knots* in both US and British editions and the latter is about \$5.50 less.

Sauna is highly recommended. The one pictured is highly over-designed. I think Sears or Wards is selling them in the US. The Finnish Embassy should be able to get information (probably a demonstration, too). My ex-landlord put one in his bathroom by building a platform hinged over the tub (toilet, sink, and shower in an adjoining "dressing room"). Swedish public baths usually have two rooms, one at 165°F and one for adults only at 212°. I can stay about 30 minutes in the cool one, and 5-10 in the hot one - about average. If you build one, don't get all prudish and put a lock on the door - don't even use a door knob - something could get fatally stuck.

The monomatic-type toilets have been available here for several years. The chemicals (which keep the smell down) have caused problems since they utterly destroy all bacteria. Thus, when you dump the bucket in your friendly neighborhood sewer system, their bacteria (which eat the garbage) are destroyed which makes them unhappy.

Martin Minow
Bromma, Sweden

The Forest People

Group dynamics and nonstructured encounter within small community situations. Childraising within communal families. Man in concert with his environment, rather than in conflict with it. It's all here, along with strands of something akin to parts of *Don Juan* or the *Tao Te Ching*. Colin Turnbull spent more than a year living among the Pygmies of the Ituri Forest of the Congo, and at the end of that time he found it difficult to return to the world outside the forest. His lucid and beautiful account shows why. If you're trying to live in a forest (or a desert, for that matter), or if you're trying to make it as part of a communal family, this book can really help keep your head in the right place.

Don Roberts
Santa Cruz, CA

The Forest People A Study of the Pygmies of the Congo

Colin M. Turnbull

\$1.25 postpaid

from:
Doubleday & Co.
501 Franklin
Garden City, N.Y. 11531

It was as though the songs which lured the "animal" to the fireside also invoked some other kind of presence. As the evenings wore on toward morning, the songs got more and more serious, and the atmosphere not exactly tense but charged with an emotion powerful enough to send the dancers swirling through the molimo fire as though its flames and red-hot coals held no heat, as though the glowing embers were cold ashes. Yet there was nothing fanatic or frenzied about their action in dancing through the fire. Then there was always that point when the "animal" left the camp and returned to the forest, taking the presence with it. I could feel it departing as the mellow, wistful voice of the molimo got farther and farther away.

If you ask a Pygmy why his people have no chiefs, no lawgivers, no councils, or no leaders, he will answer with misleading simplicity. "Because we are the people of the forest." The forest, the great provider, is the one standard by which all deeds and thoughts are judged; it is the chief, the lawgiver, the leader, and the final arbitrator.

The complete faith of the Pygmies in the goodness of their forest world is perhaps best of all expressed in one of their great molimo songs, one of the songs that is sung fully only when someone has died. At no time do their songs ask for this or that to be done, for the hunt to be made better or for someone else's illness to be cured; it is not necessary. All that is needful is to awaken the forest, and everything will come right. But suppose it does not, suppose that someone dies, then what? Then the men sit around their evening fire, as I had been doing with them for the past month, and they sing songs of devotion, songs of praise, to wake up the forest and rejoice it, to make it happy again. Of the disaster that has befallen them they sing, in this one great song. "There is darkness all around us; but if darkness is, and the darkness is of the forest, then the darkness must be good."

... It does not matter which hut, because as far as the child is concerned all adults are his parents or grandparents. They are all equally likely to slap him for doing wrong, or fondle him and feed him with delicacies if he is quiet and gives them no trouble. He knows his real mother and father, of course, and has a real affection for them and they for him, but from an early age he learns that he is the child of them all, for they are all children of the forest.

Alternate Society

There is a newspaper published in Ontario called Alternate Society.

I think a lot of people who get the Whole Earth Catalog for its' use as a tool and so forth, would be interested in subscribing to a newspaper on commune living.

The paper gives information from to and about people living all over the Western Hemisphere in communities of love, peace and self-sufficiency.

It brings forth the spiritual as well as physical and economical means of surviving when one decides to live such as this.

Alternate Society
113 Queen Street
St. Catherine, Ontario
Canada

12 issues (bi-monthly) \$3.50

K. Bunin
Edison, N.J.

Njubo was there to greet us, and the first thing he asked was whether I had been able to keep up with the others, or if I had "walked like the BaNgwana." He then turned to the others with an obvious "I told you so" air and said, "You see, it is all right; he knows how to walk." Walking, to the Pygmy, means being able to run swiftly and silently, without slipping, tripping or falling. Every day he depends for his food on his ability to "walk", and more than once his life will be saved by the same ability, when he has to run from a charging buffalo or creep away unnoticed from a sleeping leopard.

They stood there, quiet and still, and it struck me with a sudden shock that not one of them carried a spear or bow and arrow. As they peered into the dusk and cocked their heads first on this side then on that, satisfying themselves that we were really alone, it seemed that they felt themselves so much a part of the forest and of all the living things in it that they had no need to fear anything except that which was not of the forest. One of them said to me, later, "When we are the Children of the Forest, what need have we to be afraid of it? We are only afraid of that which is outside the forest."

Moke took the place in the center of the camp where Manyalibo had stood, and where everyone stands who wants to address the whole camp formally. He gave a low whistle, like the whistle given on the hunt to call for silence. When everyone was quiet he told Manyalibo that the noise was giving him a headache, and he wanted to sleep. Manyalibo retorted that this matter was more serious than Moke's sleep. Moke replied in a very deliberate, quiet voice, "You are making too much noise—you are killing the forest, you are killing the hunt. It is for us older men to sleep at night and not to worry about the youngsters. They know what to do and what not to do." Manyalibo growled with dissatisfaction, but he went back to his hut, taunted by well-directed remarks from Kenge and his friends.

This incident illustrates one of the most remarkable features of Pygmy life—the way everything settles itself with apparent lack of organization. Co-operation is the key to Pygmy society; you can expect it and you can demand it, and you have to give it. If your wife nags you at night so that you cannot sleep, you merely have to raise your voice and call on your friends and relatives to help you. Your wife will do the same, so whether you like it or not the whole camp becomes involved. At this point someone—very often an older person with too many relatives and friends to be accused of being partisan—steps in with the familiar remark that everyone is making too much noise, or else diverts the issue onto a totally different track so that people forget the origin of the argument and give it up.

The Johnson Smith Catalog

If you were ever a kid, you remember Johnson Smith. But you may have forgotten just how relevant Johnson Smith could be to your present happiness, not to mention your spiritual development.

Remember their ads in the inside cover of Little Lulu? Remember the lists you used to make of all the things you wanted? Well, surprise! You'll still want the same things: secret agent pen radio, juggling kits, X-Ray Spex, Beatnik Disguise, Magic Money Maker, joy buzzers and, of course, VENTRILO ("BOYS! BOYS! BOYS! Learn Ventriloquism and Apparently THROW YOUR VOICE! Into a trunk, under the bed, under a table, back of the door, into a desk at school, or anywhere. You'll get lots of fun fooling the teacher, policemen, peddlers and surprise and fool your friends besides.")

Yes, Johnson Smith is alive and well in Detroit. Johnson Smith hasn't changed. But what about you? Get with it, kids! This is what you've been looking for and it's been on the inside front cover of Little Lulu all the time.

Johnson Smith Catalog
80 pages
FREE!
16535 E. Warren
Detroit, Michigan 48224

P.S. If you ever get the chance, pick up an old J-S catalog. (They've been publishing them for over 50 years). Incredible bargains: Like alligators for \$1.50. Lions for \$75. And pages of "indoor fireworks." Many of the old items are still listed, in the same form. (for example, page 49, "LEARN TO TAP DANCE" "Why envy the easy rhythm and fascinating grace of Step'n Fetchit.")

Peace.
Robert Goldman
Oakland, CA

ROCKET MANUAL FOR AMATEURS



Amazingly complete and authoritative 380 page handbook that covers Rocketry

Covers: Basic Rocket Design, Motor Systems, Rocket Propellants (Solid & Liquid), Instrumentation, Safe Testing Procedure, Layout & Construction of Launching Site, Safe Firing Procedure, Tracking & Evaluation of Data, Summary of State Laws Governing Amateur Rocketry, Complete Mathematical Tables, Organization of Amateur Rocket Groups, Legal Codes and Safety Procedures, Fuel Formulas, Dictionary of Terminology, List of Other Books. 100 illustrations, diagrams, plans. Equal to books selling for \$10.00 and more.

1008. Rocket Manual for Amateurs. Postpaid...\$1.25

PRECISION BLOOD PRESSURE METER



Genuine medical instrument that gives accurate readings. Invaluable for watching your health and diagnosing specific ailments. Fully adjustable with metal hook and metal posts. Vinyl carrying case.

6009. Price Postpaid...\$14.95

SUPER MINIATURE MOTOR



Powerful prize-winning motor drives cars, boats, cars, model models. Ready-to-run. Micro size motor, power culture. Used in famous model electric autos. Many uses. 2ma. 1X 1X1/2 in. operates on single flashlight cell. 2500 r.p.m. self-starting; reversible; plastic housing; long battery life.

No. 6438. Miniature Motor. Each... 85c

UNDERWATER MOTOR



POWERS BOATS, SUBS, ANIMALS, etc. IN OR UNDER WATER! Amazing imported precision submarine power unit runs hour on single pen-cell. Nearly TEN MILLION sold all over world before being brought to U.S. Waterproof sealed, adjustable rudder, built-in switch. 4500 RPM. 5" long. Suction cup or V-mount.

7435 Price Postpaid\$1.00

Magic Nose Flute



Rich, flute-like music easy to play. Loud whistles, effects. Fits over nose & mouth. Produces the most novel effects you have ever heard!

No. 347B. Price, Postpaid..... 25c

50 FOOT MONORAIL



FLY THROUGH THE AIR WITH THE GREATEST OF EASE! Thrilling Monorail gives fast or slow ride, whatever you wish. Ball-bearing pulleys, comfortable handlebar grips, 50 foot line, all hardware for easy erecting on trees, house, etc.

7047. Complete Set Postpaid...\$7.95

PRACTICAL Mind Reading

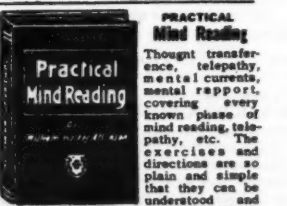

Thought transference, telepathy, mental currents, mental rapport, covering every known phase of mind reading, telepathy, etc. The exercises and directions are so plain and simple that they can be understood and demonstrated by any person of ordinary intelligence. Tells how thought transference is practiced in scientific laboratory and by public performers. Tells how to perform feats that will mystify an audience and arouse the deepest interest and enthusiasm, or conduct experiments. 96 pages.

No. 1987. Price Postpaid\$1.25

Kids' books

Since some of your readers have expressed an interest in children's books, I think they would find *The Horn Book Magazine* most helpful. It is put out six times a year and can be obtained from the publishers: The Horn Book, Inc., 585 Boylston Street, Boston 02116. It costs \$6.00 a year. Every issue reviews all the most recent children's books that are thought by them to be worthy of reviewing. There are also articles by well-known children's authors and illustrators and librarians, news of recent children's book awards and a page featuring children's own writing and drawing.

There is also an English counterpart to *The Horn Book*, which gives news of new English children's books. This is: *Children's Book News*, available from Children's Book Center Ltd., 140 Kensington Church Street, London, W.8. It also comes out six times a year and the U.S. subscription rate is \$5.00 a year.

Joan Schwartz
Petaluma, CA

Sesame Street

"Sesame Street" is the name of a dandy little-kids' program on educational TV which deals in an entertaining way with rudiments—like 3, and 5, and nose, and before.

To augment the series there's a "Parent/Teacher Guide to Sesame Street", published monthly, costs \$2, from:

Guide
Box 9070B
St. Paul, Minn. 55177



teaches THE LETTER K (as in keys)—
LISTENING—and

what are little children made of?

(the parts of the body)

Play "Big Bird Bids You" (a new version of Simon Says). The game goes this way: whatever Big Bird says, everyone must do. "Big Bird bids you touch your hair. (Everyone must touch his hair.) Big Bird bids you touch your eyelashes. (Everyone touches his eyelashes.) Play the game so that everyone stays in the game, even though he makes mistakes. Give each child a chance to be Big Bird and to tell the other children what to touch.

Make a body poster for each child. This is an activity children enjoy doing again and again. Don't hesitate to use it as often as you can. Have each child lie down on a large piece of paper. (Several sheets of paper taped together will do.) Trace around him with a crayon. When he gets up, he will see a life-size outline of himself. Have him color it in to look just like himself. As he names the parts of his body, write their labels on the poster. Hang all the posters in a row on the wall. "That's us!"

Make a body poster.

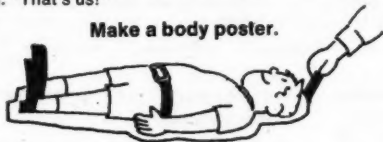

Move. Speak.

"The Movement Speakers Bureau will provide any/all of the mentioned speakers etc./ or will arrange a package event to suit your climate. We encourage everyone to expand their conceptions and mix the media whenever possible."

The speakers include Noam Chomsky, Hugh Romney, Terry Southern, Benjamin Spock, Tuli Kupferberg, Tim Leary, Abbie Hoffman, Paul Krassner, Rap Brown, Murry Bookchin, Reies Tijerina, etc. etc.

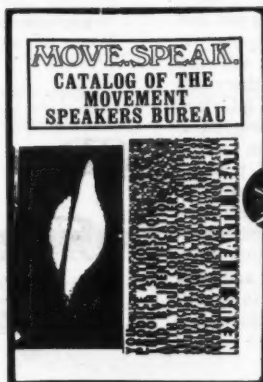

Write for catalog to:

Movement Speakers Bureau
333 East 5th Street
New York, N.Y. 10003
(212) 228-8432

Community Market

Growing since 1967, this catalog lists now 36 communities and their products: hammocks, crafts, foods, furniture, cards, quilts, moccasins, etc.

COMMUNITY MARKET was begun in 1967 to provide a place where individuals and groups concerned for social change could co-sell the products they were growing, fabricating, making or writing in order to provide income to support and extend the particular causes to which they were dedicated. We welcome all new-comers to this Fifth Directory-catalog.

No price indicated. Write:

Community Market
P.O. Box 268
Deerfield, Mass 01342



Radical Films

Some weeks ago I wrote you to place a subscription for myself for the catalog. I described my interest in the catalog and personal interests in that letter, but didn't mention Newsreel, misunderstanding your policy, which I thought was no plugs if you were personally involved in something. But I see that conflict-of-interest was only directed to "personal friends", etc. of the Catalog. So this is what Newsreel is.

We make films. We organize and travel with films to community groups, colleges, communes, workplaces, institutions. The films we make are radical, political, hopefully participatory, "documentary" or fiction. We distribute as well foreign (Cuban, Vietnamese, European, and shortly Japanese) films by brother organizations. We make films collectively, live communally and work collectively wherever and whenever possible. For some time our films have borne no personal credits. For many or most of its members Newsreel is a full-time activity, as far as possible, since only full-time office staff is salaried (at subsistence).

We are part of the capital-M Movement and of many little-m movements. The content and subjects of our films are apparent from our catalog; our educative function is to show the people (or people) how and why power should be removed from the despoilers and exploiters. Knowing these hows and whys is a cumulative process of learning by showing the films to people and talking to and learning from them.

One further thing: the catalog prices are for those institutions, etc. that can afford them. A large part of our showings are made with other, cheaper arrangements.

Hope you wish to list us among the company of tool-makers.

Martin Janal for NY Newsreel
322 7th Avenue
New York, N.Y. 10001

Learning Gear

Thanks loads, for listing our way out stuff on page 117 of the last, Fall 69, Catalog.

Sorry the price of HOW MANY: A NEW MATH PRIMER (1.95, discounts for multiples of 10) was not included. A copy of it and many other things plods on its way to you.

Mujji Ubu, 230 Yale Ave, Kensington, Cal, has a number of our things including

HOW MANY
FIRST ABACUS
ABAMAT (a special abacus)

our fantastic delirious color box RAP 1 \$35.00

our unbelievable MONEY BACK GUARANTEED first reading program (3 minutes' classes for six weeks and your weenie is reading Dr. Suess, P.D. Eastman, or McGuffey, depending on your hangup—no failures yet, and no readiness criterion—slum kids, nonverbal amentated kids, all kinds of crazy kids, "normal" 4 year old, non reading 14 year olds, you name it. \$25.00

and a whole bunch of other stuff.

John Holt tells me that I can tell you that he has bought half a dozen MODERN READING. And he also tells me I can tell you that my new book: THE SPECIAL CHILD: A HANDBOOK FOR BEHAVIOR CHANGE is the most important book around (Acropolis, Wash DC 1970) \$7.50 and that you will get cancer if you don't read it. Holt is such a good damned marvelous man.

I hope you like all the klutz we are sending you. We are probably the most \$\$ successful intentional community not based on sectarian religion (13 of 34 are kind of Brethren in a more or less Hutterian sense) and we also think we are successful in the non \$\$ areas. But man does not live by spirit alone, but by bread. We will consult, for free, to communities that practice common ownership, and for a fee to hospitals and other institutions, or communities that are addicted to property.

We also welcome visitors, but, since we are in the midst of a filthy fight with politicians we encourage them to come clean, shaven and Brooks Brothered. Freedom and dignity for kids are more important than other atavisms.

Peace,
George Von Hilsheimer
Box 606
Orange City, Fla 32763

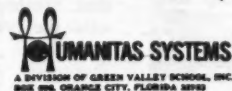

Black Reading List

Robin's Distributing Company lists 600 books "relating the Black Experience" and 200 or so other revolutionary political titles. Looks pretty comprehensive.

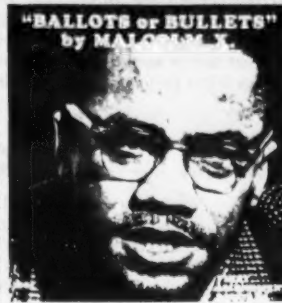

Catalog
free

from:
Robin's Distributing Company
6 North 13th Street
Philadelphia, Pa. 19107

Larry Robin (see above) suggests

Dwelling House Construction by Albert Dietz Van Nostrand Co. An excellent book on frame construction. Although you need some background to be able to handle it. In outline form including specification clauses—diagrams—tables & step by step directions.

and

Handi-Fax \$7.50 from LeFax 22nd & Sedgley Ave. Phila. Pa. Mainly diagrams & tables—precise ans to specific questions i.e. what do you need for 100 sq ft of brick wall 4" thick with 1/4" joint thickness

ans 698 Bricks
3.98 cu. ft. mortar
or what floor joist for 16" spacing—20' span—130 lb live weight

ans 3 x 16
with these books we built our house.

The catalog is great.

My only criticism might be that it is non-political but then I guess maybe political things should be separte. Same goes for fiction.

Larry Robin
Philadelphia, Pa.

Navigational Electronic Boyscout

RE: Navigational and associated arts. There is aviable from the U.S. naval Oceanographic Office (Washington, D.C., 20390) a weekly Bulletin called NOTICE TO MARINERS. I get it in the world edition which contains navigation and other useful goodies for the whole world but I am told that it is aviable in various other editions for smaller areas, like local Coast Guard Districts. Furthermore its free, as far as I can tell. You can pick up copies for current weeks at the local Coast Guard Office, Coast and Geodetic Survey Office or the ESSE offices. Or you can have it mailed to you directly by wirting to the U.S.N.O. office in Washington.

2. I saw nothing in the edition of the Catalogue which I examined at some lenght (Spring '69 and the July Supplement) about Correspondence Schools. In a day when information is vital and education is a tool to get at the rest of the world, I think this is by far one of the easiest ways to get information in a means which will keep you going till you finish the work. Of course, we can suspect bad eggs among the many that we hear of today But I can give you information on one branch.

THE CLEVELAND INSTITUTE OF ELECTRONICS offers courses in Electronics of several levels. The materials are well written and through. Units of study are rounded out by an examination which is mailed in, corrected and returned complete with commentary. Service is excellent, and they do just what they say "to teach you electronics" Cost is average but many of the courses carry a money back guarantee if you fail the Federal exam for the Commercial radio license, after receiving a CIE Certificate.

I'm currently checking into a Business correspondence School which is supposed to be decent.

3. RE: Heathkit. I am an electronics engineer (among other things) and find the Heathkit goodies great. In one piece of work I did I got into a discussion of its quality with another (more experienced) engineer and we had a run off between my Heathkit stuff and his Hewitt-Packard equipment (which is supposed to be the best, and is the most expensive). Heathkit won, hands down. What can I say, I was amazed.

4. In your July Supplement you asked for comments of the Boy Scout Handbook. The latest edition (7th, fifth printing 1/1969) is by far their best. BSA is very conservation conscious and have modified many of their ealier outdoor practices, to help teach that to stay on this earth we had better damn well conserve it. Through the various editions there is a slow drift away from the "goodie goodie two shoes" outlook on life, though it still sticks to the basic premises of a good life. Thankfully it has become less puritan and more healthy american. In general it is written for use with in the organization for the boy climbing the rank ladder, but will be easier for a boy to learn about a lot of things than using its big brother THE FIELDBOOK. Well written, well illustrated and bound so that it will take a beating. Mine lasted through 10 weeks of wilderness outcamping and looks good as new binding wise. Its always nice not to have to re-staple the pages in. Sct, still a dollar, from the local BSA distributor, or direct from Publication Services. B.S.A., New Brunswick New Jersey.

Theodore E. Parks
New York

Replace cars before they replace us



I see this page in *New Suggestions* was left blank by mistake, which presents a fine opportunity to demonstrate further the need for better transportation means than the automobile. With all the row about air pollution by cars, their more direct deadliness by impact gets overlooked. The internal combustion ground capsule was alright for its time, but surely something better can be invented. If not, then bring back the bicycle and the horse, and let Detroit go.

D. A. Latimer's article was printed in the Nov. 19 East Village Other. \$6/yr (weekly) from 105 Second Ave., New York, NY 10003.

Now, at the very bottom of the yonder side of that hill—and mind, the east slope is strikingly steeper than the west—lies a fine green house, beyond a driveway flanked by two skyscraping elm trees. That's my house, where I grew up, and the curve at the crest of the little hill above it is frequently called 'Latimer's Curve' in the accident stories in the local papers of St. Lawrence County. Now, there's another house at the top of the hill, but no family who ever lived there was privileged to have the curve named after them: by the time the accidents are through happening, you see, they're generally found in our front yard, thanks to the steepness of the eastern slope of the hill. Fewer mishaps occur on the level west slope, and they tend to be less spectacular.

But if you aren't altogether sober, or very much familiar with the terrain, you're bound to have trouble with that curve. A lot of hard rubber is burned there, I used to wake up often in the night hearing it and waiting for the French-horn sound of steel and iron crumpling, and the long shatter of glass. It happened rarely enough—two or three times a year—but when it did I'd get up and call the state police.

You have to call the state police to get an ambulance, see, otherwise they won't come right away. I was always reluctant to do this, out of an instinctive reluctance to do business with the Pig, and so I'd generally check first to make sure an

ambulance was needed, until the night three teenage girls bought it on the west slope. That was a bad one, and after that I tried to make sure there wouldn't be one second wasted, even for a nosebleed. But let me tell you about that particular Saturday in November of '62—just after the Cuban Crisis—when all those college guys piled up on our lawn.

The first one happened around eleven in the morning. It was a chilly day. I was splitting wood in the garage when the familiar squall of rear tires locking on the curve and sliding over sideways brought me up short, listening. Sure enough, there was a sharp preliminary bang, and then another long squeal—they're coming down the hill sideways—and then a great extended classical funneling sound as she fell over along on her side, and the rolling with a long chitter or broken glass and shearing fibreglass, and two flat bouncing bashes. By this time I was around the corner of the house, running off toward where a flattened white corvette was lying belly up in the hayfield on the other side of the road. Ma could call the troopers.

Every year a couple hundred thousand people are slain on the highways of America. Slain. Killed. Snuffed out. Their families grieve, gifts of food are clumsily tendered over by well-meaning acquaintances, the preacher is called and the insurance man comes around with a glum face. Two hundred thousand or more every year. Dead. Of course, it's really quite

difficult to die by accident, and thus a correspondingly higher number of people are mutilated every year, many permanently. They go to hospitals. Well-meaning acquaintances bring flowers, and the insurance man comes around with a sour face and gruffness in his voice. Every year this happens.

Sure, everybody else will be writing about the November Moratorium this week, driving the EVO typesetters insane with planks and cords of last-minute copy. But being that whatever has happened in Washington was fated to have happened, and since the obscenity trial of The New York Review Of Sex & Politics had to be covered Friday, I am not going to write about the November Moratorium. Because more Americans are killed on the roads every year than are killed in Vietnam—and for precisely the same reasons—I want to dwell this week on a subject that is closer to the hearts of all Americans, both the quick and the silent. Gore.

About eight miles due east of Canton, New York, along the old Pierrepont road, there lies a little round hill, sort of an antehill to the much taller, steeper hill just beyond it. The highway heads straight at this little hill up a moderate grade, and not until you get to the very top of it do you notice that your car is halfway already through an extremely sharp curve to the right. Hit the brake, idiot! An observant driver would have

noticed, about a hundred yards back, a dingy yellow sign perforated with bullet holes of various calibres, and the sign indicating a rightward curve, saying, 25 MPH. But it's pretty heather country along that stretch, and to the left is the pasture where Jimmy O'Brien's two huge lovely grey and white work-horses graze, so I could not fault you for missing the sign. So many people do.

By the time I got there, a guy was already rolling out from

under the driver's side of the car, kicking himself loose of the twisted aluminum. The front tire on his side was still spinning madly, wobbling a little. As he stood blinking at the flattened corpse of his new Corvette, another kid slowly goosed his way out of the other side of the thing, on his belly, ripping the shoulder right off his jacket on a spike of crumpled fibreglass. They're all right, I thought, they're both all right. Thank God...

But then the driver hollered 'Mike!' suddenly, snapping awake, racing around to the other, higher side of the car, and they both gripped under it and tried to tip it over, shouting, 'Mike! Mike! Can you hear me, Mike? Are you all right, Mike?' So I got down with them and we tried to get her over. But it was too heavy, and when it rocked back a little I nearly puked at the thought of what it was rocking against. Casting around, I found a fencepost and a large rock. 'Here.' Setting the rock against the car, we jimmied the point of the post under it, tipped it up, and gripped the side and threw it over onto its springs with a bash.

Mike slipped out of the open right door like a finger out of a glove, joint by joint.

He looked dead. He was blonde, built big like a middle linebacker, but there wasn't a drop of colour in his skin. He was whiter than this paper, white as the belly of a trout. The other two guys just stared, but I dropped down to find his pulse. His wrist was warm and wet, if flopped into my hand by its own relaxing muscle tone. I couldn't find a pulse, but then his eyes opened, drawing my attention to his face. The aluminum windshield frame had been lying right athwart his nostrils, there a perceptible grainy dent, a semicircular cup in the bone structure where his nose met his forehead. One of his eyes was twisted slightly out of line with the other, and when he opened them blood escaped from them in small red lines down both sides of his face. They were not

like tears, those lines, they were blood. His eyeballs swam in blood as he blinked them, trying to clear his vision. He tried to mumble something. 'Easy, Mike,' one of his friends breathed, 'easy, now. You're all right, Mike.' Desperation started to creep into his voice, but he choked it off. 'You're all right.'

Ma came out with bandages. The police didn't get there for twenty minutes; the ambulance took longer, the wrecker showed up before it did. Blood had started running down the driver's head in crazy patterns by that time, into his shirt, which he'd unbuttoned after taking off his jacket. He seemed very hot for some reason, dabbing sweat and blood away from his face as he limped around nervously answering the troopers' questions. Finally, as they were hooking his Corvette up to the truck, pieces of glass and machinery falling from its belly, I heard him say, 'Why? Why do these things just have to happen to you? Why?'

You just never know when these things are just going to happen to you. Not twelve hours later, around eleven that night, I was watching 'Gunsmoke' when I heard an altogether new noise out front. This time there was no premonitory shrilling of brakes and rubber, just an indescribable racket of something falling down and down and down, as a pair of headlights pinwheeled past the living room window. I called the police myself this time, and ran out.

It was worse this time. In approximately the same place as the Corvette, in the hayfield, lay a vaguely rectangular automobile, its headlights still on, glowing out toward the woods. The road was littered all the way up the hill with broken glass, bits of metal and rubber and a few streaks of slick wet stuff. I later learned that the car was a TR-4, but at the time I thought it had been an MG, it was so bashed together. In the middle of the road lay a human being.

He rose to a sitting position as I approached. 'Where's my shoes?' he asked, feeling around him. One side of his head looked as though it had been caught in a mangle iron: it looked burned, ragged, the flesh peeling away and the hair matted under the brilliant blood. 'Where's my shoes?' he asked dreamily, feeling around the square patch of leather on which he was sitting. 'Where's my shoes??' He was beginning to sound querulous. He wasn't wearing any shoes: one brown stockinged foot projected at an acute angle from his ankle, and he seemed very careful not to move it as he looked for his shoes. 'Here, lie down,' I told him, pushing gently at his shoulders. 'I'll find your shoes. Be back in a jiffy.' He lay down, gratefully, relieved of the responsibility of finding his shoes.

No one was in the car. All four wheels were turning noisily in the air, the radiator was cooling with a soft hiss, clouds of steam piled out between the headlights. As I was still checking around it, I heard a siren off to the west,

approaching rapidly. I sprinted like a sonofabitch for the top of the hill to wave them down: the way those troopers drive, they'd be over that guy in a second without even noticing him. Waving my arms frantically, I managed to slow them down a little, and they screeched to a stop a few feet short of him. He tried to struggle up in the headlight flare, gave up, and settled back down.

Night-shift troopers are much quicker than day-shift troopers. Also they are bigger, monsters, I don't think men that size come out by daylight: six-seven, six-eight, and all of them broad and heavy-wristed as Vikings. They moved around in the headlights of the two cars like bad old dreams from childhood, and I was glad when the ambulance showed up.

After the shoeless guy was strapped quietly onto the stretcher and carried away, I was temporarily arrested by the sight of one of our barn dogs quietly chewing on the blood soaked square of leather roof in the middle of the road. A little ways beyond was a thick red gob of something which turned out to be the tip of somebody's tongue.

Suddenly I noticed that there were wide gleaming streaks and pools of blood all over the road that would leave stains for days. Then a trooper called me over to the side of the road a few yards up the farther hill.

'Gimmie a hand with this stretcher.' Sure enough, there was a body in the ditch, about fifty feet from the steaming car. It was a body, he was dead. No question about it, he was flat, all the life had been crushed out of his face and his chest and his pelvis. He seemed about ten feet long. I took his ankles and shifted them onto the canvas stretcher: he was wearing red socks and loafers, and there was a deep bloody unbleeding gouge a little further up his shin, which was hairy and dead.

Actually, when we got him into the light, I saw he was really pretty short, not long at all. It surprised me. But he was dead.

When they hoisted the car onto a little aluminum wheel frame to cart it away, one of the wheels drew up straight into a trooper's flashlight beam: it was a spoked wheel with a pointed hubcap, and the blood was dripping off the spokes, all the spokes, gleaming. There was a dent in the hubcap.

Now, things like this happen every day around this country. People die, hundreds of thousands of them. They buy their cars from the smiling, sincere auto salesman, get the warranties and the insurance cleared up, and they become very proud of their cars. They drive to work in them every day, take their loved ones for rides in them, they budget for gas and oil right along with breakfast cereal and Christmas presents. They put things in the glove compartment and under the seats, things they're fond of. They wash them and polish them. Then one day it just happens to you and your car lashes out at you and turns into a killing thing that hates you and maims you and the people you love. It happens, and it will keep happening as long as there are cars. No nationally televised road safety education program is going to stop it. You can't stop it by becoming the best possible driver you can: that won't help you avoid it, and it won't save one life from the hundreds of thousands who died this year, who will die next year and after that. Nothing's going to stop it, until the private automobile is banished and free mass

transport is provided everywhere.

But that's Commie talk, right? If I had the power, I would deprive you of the privilege of owning your family car, which makes me some sort of Red, right? Why, if cars were banished, what would Standard Oil do? What would Firestone rubber do? We've been fighting in Vietnam for ten years for the oil and rubber rights, so I got a lotta gall to want to sabotage those industries. Right? Right!

Fucking A, Mac. And when they bombed General Motors and Standard Oil here last week I was not among those who were enraged and bewildered at the 'senselessness' of the operation. Power to you, Mac.

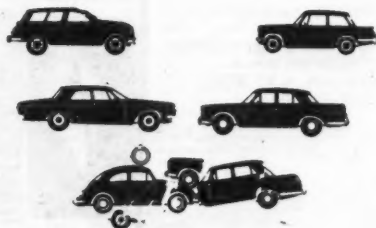

Composting

With regard to composting and shredding and general methodology, another of J. I. Rodale's books, "The Complete Book of Composting" is useful, covering all aspects, from the home compost pile to the composting of city wastes.

An alternative to buying a shredder is a rotary mower, which makes a satisfactory substitute. Run it back and forth over a small pile of waste, ejecting it against an upright board or wall. It's faster if someone helps by gradually feeding the pile. Prevent stalling of the mower by raising the front end. Usable compost can be made in only 14 days. Important factors are shredding the wastes, moisture, nitrogen (manure or bloodmeal), and turning the pile every three or four days.

Yours truly,
James Greene
North Guilford, Conn.

Garbage As You Like It, and Compost Science

The author of the garbage book and editor of the compost magazine, Jerome Goldstein, phoned us recently, and we got talking about the need for an ecological Consumer Reports. Since then he's placed an inquiry in the Rodale magazines asking for reader information on "good" products. Send any you have to Rodale Press, Inc., Organic Product Dept., Emmaus, Pa. 18049.

Goldstein's book and magazine are both invaluable if you're seriously into cycling wastes, from personal scale to urban. The information is no recent fashion gloss, but solid stuff. Garbage is full of energy; here's how to recover some of it.



Garbage As You Like It
Jerome Goldstein
1969; 243 pp.

\$4.95 postpaid

from:
Rodale Books, Inc.
Emmaus, Pa. 18049

Compost Science
Jerome Goldstein, ed.

\$4/ yr (monthly) in US & Canada
\$4.50 elsewhere

from:
Compost Science
33 East Minor St.
Emmaus, Pa. 18049

Cycle Parts & tools

How bout lisiting cycle parts from England. One co. I've had super service from and saved lots of money . . . fast too is

A. A. Snell & Sons
126 Boundary Road
Walthamston, London E17

Stanley Tool Guides—I'm not sure these are still available but Stanley used to give out sheets on use of all their hand tools. They not only show how to use & sharpen a chisel but in detail to do stuff like hang a door, make dovetail joints. The complet set is really a book.

Drew Langsner
San Francisco, CA

Filmmaking

I suggest—*Guide to Filmmaking* by Edward Pincus. Signet No. W3992. \$1.50 paperback.

A practical, nuts & bolts type introduction to accessible filmmaking (8 & 16 mm). A lot of information for someone starting. I believe it is the basis of a course in filmmaking the author teaches at MIT.

J. B. Lisle
Pittsburgh, Pa.

Soleri's book at last

Arcolego: The City in the Image of Man
Paolo Soleri
\$25.00
Publisher: M.I.T. Press
Supplier: The Cosanti Foundation
6433 Doubletree Road
Scottsdale, Arizona 85251

I've been apprenticed to Soleri and have seen this book in the making. It's a mind blower—and a natural for the WHOLE EARTH CATALOG.

Note: I've distinguished between the publisher and the supplier of the book because Soleri's Cosanti Foundation will make some profit from every copy it sells—and it's no more expensive to order it from the foundation than from M.I.T. directly.

[If you've been an apprentice or even a visitor at the foundation you would understand why it's important to give it a break: some big ideas are coming out of it.]

Ralph Wilcoxon
Richmond, CA

Mother Earth News

Similar market to WHOLE EARTH CATALOG. More into process—and less into tools—than we are. Wider use of reprinted material. Different flavor than us. Looks like it may survive. It should be reviewed by somebody other than me: review invited.

From masthead:

THE MOTHER EARTH NEWS is a monthly "how to" magazine edited by, and expressly for, today's influential "hip" young adults, The creative people. The doers. The ones who make it all happen. Heavy emphasis is placed on alternate life styles, ecology, working with nature and doing more with less.

STAFF

John Shuttleworth
Jane Shuttleworth

Contributions of articles and photographs are invited and will be gratefully acknowledged. Manuscripts and photos can be returned if accompanied by return postage.

Reproduction by all other news media is welcomed and invited with mention of the source. Reproduction for commercial or advertising purposes is not allowed without written permission.

Opinions expressed by authors and correspondents are their own and not necessarily those of the publisher.

EDITORIAL AND SUBSCRIPTION OFFICES

P.O. Box 38, Madison, Ohio 44057

Single copy price/\$1.00. One year (12 issues)/\$8.00. Two years (24 issues)/\$14.00. Charter subscriptions (good during first two months of 1970): One year/\$6.00. Two years/\$10.00.



Indian Uses of Native Plants

This book is more than a guide to medicinal plants used by the California Indians. It is a log of ceremonies, customs, feasts, and the Indian culture as it existed at that time. Topics include: Hair; Tepees; Ceremonies & Magic; Tanning Hides; and so on.

The book offers an understanding of how the Indian here dealt with his environment and made the very best of it.

Michael Handler
Atherton, Calif.

BIRTH CONTROL

At Elko, Nevada, when the baby is one month old, a trench is filled with warm ashes. The mother lies down in them, meanwhile drinking tea from boiled root of Desert mallow, wild geranium, (*Sphaeralcea ambigua*), "Nuna naka," Shoshone. Said to be safe from pregnancy until the baby is a year old.

At Beowawe, daily use of tea made from fresh root of False Hellebore (*Veratrum Californica*), "Tobassop," "Wundavassop," Sho.; "Baduppa," Washoe. Tea from cured root of same ensures sterility for life.

STONE SEED, PLANTE AUX PERLES (*Lithospermum rudicale*), "Not misha," at Owyhee. Handful of dried root, chipped, boiled in water to cover, and tea used daily for six months, results in permanent birth control.

JUNIPER BERRIES (*Juniperus spp.*), "Sammapo," Shoshone. Tea from berries taken on 3 successive days, a cupful each time, said to be efficacious.

[Has anyone verified this?]

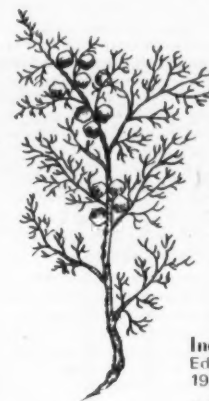

Juniper

Indian Uses of Native Plants

Edith Van Allen Murphey
1959; 81 pp.

\$2.50 ?

from:
Mendocino County Historical Society
243 Bush Street
Fort Bragg, CA 95437

Peoples Medical Handbook

Fourteen pages of brisk basic street medicine—nutrition, cheap food, dope, first aid. Appears to be free (send postage) from:

Christian Revolutionary Medical Committees
P. O. Box 5092
Berkeley, Calif.
94705

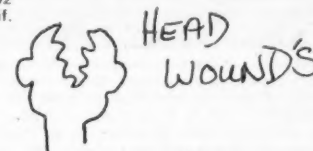

Any hard blow to the head can cause a concussion, which is dangerous. Anyone with a head wound should be watched closely for:

1. Vomiting
2. Excess sleepiness
3. Persistent headache
4. Double vision
5. Unusual behavior

If these symptoms in any combination occur, find a doctor.

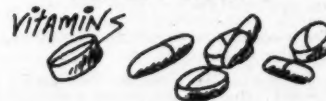

You need at least 100 grams of protein each day. Meat is one of the best sources, but expensive. Some prepared breakfast cereals like Kellogg's Special K have 20% or more protein. Skim milk powder is inexpensive and quite high in protein. The amino acid array in milk proteins and cereal proteins are different from each other, so if you combine them in the same meal you get protein equivalent in essential amino acid—balance to meat. Cereal and milk powder protein will cost about half as much as protein in meat. In suggested menus we will tell you about some other good protein sources.

The Outlaw Area



From Arthur Godfrey to Esquire

Incredible as it may seem, man now finds himself actually listed as one of the endangered species, not in the next thousand years or even the next hundred—but within the next thirty years—all that's left of the twentieth century.

That isn't very much time. To my generation, thirty years is a mere snap of the fingers. Thirty years ago Hitler had just struck in Poland, but World War II was still two years away. F. D. R. hadn't completed his second term and Mussolini was riding high in Italy, and it all seems as though it were just yesterday. Mark you, those under thirty: today will seem just like yesterday to you, too, in 1995 and 1999—if anyone still lives!

Don't laugh and don't shrug: many astute ecologists are convinced we already have had it! They've been trying to tell us so for some time. Still, I think we'd be less than human if we didn't hope, so let's look at the facts: man evolved, we are told, about two and a half million years ago. In all that time he never numbered more than four or five hundred million, until about the beginning of the nineteenth century. Despite a few festering spots of human concentration like Rome, Athens, Cairo, India and the Far East, Nature seemed always quite able to handle the situation insofar as pollution was concerned. Plagues, droughts, pestilences, starvation and wars had always kept the human population under control and the winds diffused the smoke and the smells. Man fouled his lakes, rivers and harbors with his wastes and debris, of course, but the rains and tides pretty well cleansed them away. The forests of the lands and the diatoms of the seas kept the biosphere fresh with oxygen and the entire planet was very nearly the paradise the Creator obviously had intended it to be.

While it is true that man, in his stupid greed, had learned ten thousand years ago to measure his wealth in gold and jewels and slaves, he mined no coal, drilled no oil and fouled no air with fossil fuels and their non-biodegradable poisons. He was as barbarous and arrogant and as much the egomaniac that he still can be and often is, but he possessed no really harmful technology. In fact, his childish antics must have highly amused the gods of his early days.

But in the first third of the nineteenth century, he began to get the smarts, as the saying goes. He began to learn how to "conquer" the wilderness and starvation and disease and, come 1830, the world saw its first billion people alive and kicking at one and the same time. Two and a half million years had been required to accomplish this—but lo and behold, in just barely the next one hundred years, the "progress" was such that the population had doubled.

That was in 1930. By 1960, only thirty years later, the count was three billion! And here we are, at the end of the Sixties, barely ten years later, at better than three and a half billion. It doesn't take much mathematics to calculate that at this geometric rate, the population of the world by 1999 has got to be seven billion!

This planet, I think, was never intended to support that many people! Even without the coal and the oil and the internal-combustion engines and the diesels and the factory and nuclear wastes and the thermal pollution and all the rest of it, it is doubtful that nature could handle even just the feces of seven billion people!

That's why some ecologists think we've had it: runaway technology has resulted in such unimaginable population expansion that our environment just can't handle it anymore. We have so badly polluted our waters that the plankton that feeds the diatoms, which furnish seventy percent of our oxygen, is disappearing from the sea. The remaining thirty percent of our oxygen supply comes from our forests, and anyone with half an eye can see what has happened to them. Everything points to the moment soon when the oxygen content of our atmosphere will fall below the minimum required to support life as we know it—and that moment isn't very far off.

Why this isn't generally understood is beyond me. As a pilot, as a sailor, as a farmer, as a hunter and fisherman—nay, as just a lover of the outdoors—I have been very conscious of the deterioration of our environment for many years; ever since the end of World War II, in fact. I worried about it and talked about it with my friends and on my daily nationwide broadcasts.

The late Rachel Carson's book *The Silent Spring* electrified the country a few years ago but still there was no accurate documentation. I personally had noted the pollution of the Hackensack, Passaic, Delaware and Potomac Rivers where I had once fished and crabbled to my heart's content. I had observed that, whereas formerly it had been an easy matter for a pilot to find the nearest city merely by heading for the closest smog, this was no longer the case along the eastern seaboard. The entire area has become a solid mass of fog and smoke and gook. I had also noted the scarcity of eagles and hawks that once were plentiful, not to mention the wily crow and the wise old owls. All these things told me something was very wrong, but I didn't know what to do about it.

I continued to hunt big game for trophies. I, too, pumped raw sewage into the waters I cruised in my boat and, once out of sight of land, I dumped the garbage overboard, as is the custom. I smoked cigarettes and flipped the butts into the nearest gutter, missing most of the time. When the pack was empty, I dropped that in the street, too. In the fall, I raked the leaves off of my lawn and burned them in huge bonfires. Like most of my fellows, I was a thoughtless, careless citizen of the world traveling everywhere and leaving an unbroken trail of trash to mark my progress.

Then, three years ago, the Rienows, Robert and his wife, Leona, published their book *Moment in the Sun*. Here, for the first time to my knowledge, was a veritable ecological bible, as it were. Here, presented in language an untutored but interested person can understand, are the facts—carefully documented over a period of thirty years!

I read the book and I talked about the book and I quoted from the book—on the air—every day—day after day. I bought and gave away several hundred copies to my friends and acquaintances and almost anyone who even looked slightly interested.

Other books came along, notably Wesley Marx's *The Frail Ocean*, Dr. Paul R. Ehrlich's *The Population Bomb and Science and Survival* by Barry Commoner. I read and I studied. I attended seminars and symposia. I met and talked with leading conservationists and biologists and, here and there, even a full-fledged ecologist—a rare species indeed. I invited them to interviews on my broadcasts. I did and daily do my homework—reading, writing and asking questions when I'm in doubt, visiting threatened sites of remaining wilderness. I had long been a member of the Izaak Walton League and Ducks Unlimited, but now I joined more and more of these organizations in my zeal to lend a hand in the great work they are all doing.

His Royal Highness, Prince Bernhard of the Netherlands, President of the World Wildlife Fund, appointed me one of his international trustees. I met the distinguished Dr. Ira Gabrielson, President of the U. S. Appeal of the World Wildlife Fund, who appointed me to his board also, and Herb Mills, the National Director, who had come out of comfortable retirement to take on his strenuous duties. Sam and Mary Tay Pryor gave a luncheon one day last year at our Sky Club here in New York at which Charles Lindbergh and I delivered short talks and raised \$375,000 for the Nature Conservancy with which to purchase for all posterity the indescribably magnificent Hawaiian wilderness of the Seven Sacred Pools on the slopes of Haleakala on Maui. Charles Lindbergh, one of the truly great giants of world history, who has come out of self-imposed exile from public view to devote his remaining days to the cause of conservation! Together, we, and all the many hundreds now of dedicated scientists and laymen, have noted with great satisfaction the increased media awareness of our predicament. Hardly a day passes that every newspaper and magazine doesn't carry one or several conservation stories, pollution reports, anti-pollution legislation proposed and enacted. The National Wildlife Federation has published the results of a poll which shows an overwhelming majority of Americans is very much concerned—even willing to pay extra taxes to do something about it!

Thus far, however, very little has actually been accomplished. A long time ago, I began to urge the appointment of a Department of Environment. The Secretary, of Cabinet rank, I proposed, would be empowered to appoint a Board of Ecological Survey, consisting of a dozen or so of the greatest ecologists around. No one would be permitted to build a highway, dig a ditch, build a dam, "develop" a swamp or an estuary, build a jetport or anything else without first submitting the plan to this Board. The Board would determine all of the likely ecological consequences thereof, *in advance*.

Momentarily, I was heartened by President Nixon's announcement of his creation of a group for this purpose, but then I read the list: himself, Vice-President Agnew, and members of the Cabinet. All dedicated Americans, no doubt; but conservationists? Ecologists? Only one; Dr. Lee A. DuBridge. Senator Henry Jackson's bill, as this is written, holds much more promise.

What bugs me and my fellow conservationists is why our bureaucrats are dragging their feet. They all have even greater access to the scientific data to which we have been made privy. The handwriting has been clearly written on their walls as well as ours. Why can't they get it through their heads that we are already late?

Until the facts had been gathered and assembled, no one in particular was to blame: we were all guilty of fouling our nests and our atmosphere and waters, carelessly, heedlessly "conquering" our environment. But now we do know! And we have known for some time—and some of us have been shouting the incredible truth from the housetops. Ignorance is no longer any excuse.

Hence, I repeat, our country's highest priority in the 1970's must be survival. Not the Vietnamese war, not racism, not communism, not leftists nor rightists nor in-between-ists. Just survival.

It is predicted, scientifically, that we shall export our last grain of wheat in 1976—just six years away! Why? Because we will have no more surpluses to export. In fact, we don't have enough for ourselves. If the population of the world doubles in thirty years, that means it will double here, too, in America, unless I'm more successful than I have been thus far in promoting vasectomies.

Gentlemen, don't cringe, listen: double our present population means more than four hundred millions of Americans. We have only five hundred million arable, usable acres of soil upon which to raise our food. Four into five goes one point two five, doesn't it? No technology in the world is going to coax enough food out of one acre to feed one human being one year! Beef and lamb will be outlawed by the Eighties because it takes six to seven times as much ground to raise protein on the hoof as it does in the grain field. We'll all be eating ersatz products of technology made of grains and algae. If you've imagined that the oceans will make up the deficits, read that book of Wesley Marx's I mentioned: *The Frail Ocean*.

It really looks pretty bad for the human race. We have no one to blame but ourselves, but that doesn't help much. We can still beat it, I believe. But we must not lose another day.

Anyone care to join me as a Volunteer for Survival?

Ecology trip

All through the riots of '72 we watched, itching to leave the city but somehow still attached. I mean, we knew. We knew as early as '67, but it was so science-fiction that we just kind of dreamed happily over it, making incredibly detailed lists, playing with the Ouija Board, studying astrology and making predictions in an off-handedly superior way. We got disillusioned in '68, and went on a lot of sidetrips, falling in love, losing it, moving, practicing all kinds of odd crafts, having babies. We knew what was happening by '69. We had our Whole Earth catalogs, and our stash of Acapulco and Panamanian pot seeds, and we were desperately raking bread, working, trying to get it together.

It was a communal trip at first, and gradually it got thinner, down to the family, and the family seemed to be a lot smaller than we'd thought. Government pamphlets, nightsoil, organic gardening, Diesel engines, music, meditation and chauvinism mounted. We decided to leave in secret.

All the mediums, most of the astrologers, some of the psychics, and even some political economists agreed that we were eating the earth into Armageddon. So we still waited, planning, collecting. In '73 we got into our bus and split for Oregon. We drove all night and the better part of the day, slept just in time to hear on the car radio that Red China had started bombing somebody, but not us yet, thank God. We woke and drove again, through the night, and finally we got there, and fell out, exhausted. In the morning the baby started to cry.

We got up. Outside the curtained windows of our bus, through the trees and the virgin country, we saw seven tepees, three Volkswagen buses, two school buses, one Renault Dauphine with a pup tent on top of it, a half-hewn cabin, two chemical toilets, several dogs, more cats, a fire somewhere off in the distance, and standing around us were ninety-seven people. They looked hungry. They all had long hair. Nobody was smiling.

We ate the ones over thirty first.

Later, the soldiers came.

What's wrong with this story?

from *Tuesday's Child*—Vol. 1, No. 1

The Crisis of Crises

What finally makes all of our crises still more dangerous is that they are now coming on top of each other. Most administrations are able to endure or even enjoy an occasional crisis, with everyone working late together and getting a new sense of importance and unity. What they are not prepared to deal with are multiple crises, a crisis of crises all at one time. This is what happened in New York City in 1968 when the Ocean Hill-Brownsville teacher and race strike was combined with a police strike, on top of a garbage strike, on top of a longshoremen's strike, all within a few days of each other.

When something like this happens, the staffs get jumpy with smoke and coffee and alcohol, the mediators become exhausted, and the administrators find themselves running two crises behind. Every problem may escalate because those involved no longer have time to think straight. What would have happened in the Cuban missile crisis if the East Coast power blackout had occurred by accident that same day? Or if the "hot line" between Washington and Moscow had gone dead? There might have been hours of misinterpretation, and some fatally different decisions.

I think this multiplication of domestic and international crises today will shorten that short half-life. In the continued absence of better ways of heading off these multiple crises, our half-life may no longer be 10 or 20 years, but more like 5 to 10 years, or less. We may have even less than a 50-50 chance of living until 1980.

Apocalypse juggernaut, hello

As if the spirits of our ancestors weren't trouble enough, now we're haunted by the ghosts of our descendants.

Ken Kesey claims that ecology is the current handy smoke-screen for everybody's Dire Report—the voice of white-eyed paranoia. Gary Snyder (strong proponent of population control) when told of an Earth of solid people impending soon, commented dreamily "think of all that consciousness."

I tend to view the whole disaster as an opportunity to try stuff. If you take all the surprise-free projections for mankind's near future and connect them up, they lead neat as you please right into the dead end meat grinder. The only Earth we had, used up.

Unless there are surprises. Which is what we're here for. The Standard Operating Out, when a species is in a bind, is to diversify. Multiply alternatives. If you don't know what's coming, the way to evolve ahead of the changes is to try everything.

Reasonable laws made by reasonable men in reasonable times proscribe trying everything. For a good reason: people get hurt trying stuff. If you're bound to try stuff anyway, then either you're working directly for City Hall or you're an outlaw, or both.

Buckminster Fuller:

"It surprises people when you tell them that since the last ice age three-quarters of the earth has been water, and of the one-quarter that is land very little has been lived on. Ninety-nine percent of humanity has lived on only about five per cent of the earth, and anyone who went outside of it—the tiny minority that went to sea, for example—immediately found himself outside the law. And the whole development of technology has been in the outlaw area, where you're dealing with the toughness of nature. I find this fascinating and utterly true. All improvement has to be made in the outlaw area. You can't reform man, and you can't improve his situation where he is. But when you've made things so good out there in the outlaw area that they can't help being recognized, then gradually they get assimilated."

[From Calvin Tomkin's profile of Fuller, "In the Outlaw Area", *The New Yorker*, Jan. 8, 1966]

Present outlaw areas include space, the oceans, mountains, desert, northwoods and tundra, jungle, and then places like molecular biology, your mind, and other state-of-the-art frontiers whose languages are still foreign to lawmakers.

One thing we need is better outlaws. The antidote to external routine is internal routine, not sloppiness. The finding and following of your own drum. Help save the world: do something wrong today. Do it today because time is short, and capable outlaws aren't made overnight. If the famines do indeed start coming down in the mid-70's, things are going to be too tense (fortress America) to try stuff in a friendly way any more. We'll need to have operationally developed a spectrum of open strategies before then. Here following are three modest suggestions. We aren't doing them yet, so it's just loose talk.

Loose Talk 1: THE OUTLAW AREA

The specific fantasy called OUTLAW AREA is a geographical place where anything goes. Let's say it's an island.

For society it functions as a human dumping station. When a guy gets a jail sentence he has the choice of serving the sentence or being deported to the Island. He can't come back for some specific period of time, or he must meet some bureaucratic criteria to return, or the expulsion is permanent. Yessir, put all the bad apples in one bad apple barrel.

For the individual it serves as an always possible alternative to the situation he's in. He can simply split for the Island and take his chances there. No one's going to try to get him back.

For evolution it's an open end, a place for other stuff

to happen. High energy, minimum prior form, violent range of constant inputs; it should be wild. "In wildness is the preservation of the world."

It's difficult to imagine how it would be in the Outlaw Area. You can project some from the history of Australia, once a penal colony, or from the present underworld. Robert Heinlein has a book about the Moon as a penal colony called *The Moon is a Harsh Mistress*. It's kind of nice: they have a revolution and throw the jailers out.

Depending on the size of the island, my expectation would be either a dictatorship or warfare of rival gangs, like in old China, warlords. Maybe not though. This is a different age. The Island might become an Aquarian haven for the most useful pioneers—the cream and the dregs of society, (Kesey's notion) bending reality off into unimaginable directions with no restrictions save the harsh ones of nature.

Could become our best school.



Aquarian Haven

Photo from "Open Land: a manifesto" published recently for defense of the commune at Wheeler Ranch, Box 81, Bodega Bay, CA 94923.

This statement may seem uncertain and excessively dramatic. But is there any scientist who would make a much more optimistic estimate after considering all the different sources of danger and how they are increasing? The shortness of the time is due to the exponential and multiplying character of our problems and not to what particular numbers or guesses we put in. Anyone who feels more hopeful about getting past the nightmares of the 1970's has only to look beyond them to the monsters of pollution and population rising up in the 1980's and 1990's. Whether we have 10 years or more like 20 or 30, unless we systematically find new large-scale solutions, we are in the gravest danger of destroying our society, our world, and ourselves in any of a number of different ways well before the end of this century. Many futurologists who have predicted what the world will be like in the year 2000 have neglected to tell us that. . . .

Game theory. As we have seen, zero-sum game theory has not been too academic to be used for national strategy and policy analysis. Unfortunately, in zero-sum games, what I win, you lose, and what you win, I lose. This may be the way poker works, but it is not the way the world works. We are collectively in a non-zero-sum game in which we will all lose together in nuclear holocaust or race conflict or economic nationalism, or all win together in survival and prosperity. Some of the many variations of non-zero-sum game theory, applied to group conflict and cooperation, might show us profitable new approaches to replace our sterile and dangerous confrontation strategies. . . .

Social change, peaceful or turbulent, is powered by "what might be." This means that for peaceful change, to get over some impossible barrier of unresponsiveness or complexity or group conflict, what is needed is an inventive

man or group—a "social entrepreneur"—who can connect the pieces and show how to turn the advantage of "what might be" into some present advantage for every participating party. To get toll roads, when highways were hopeless, a legislative-corporation mechanism was invented that turned the future need into present profits for construction workers and bondholders and continuing profitability for the state and all the drivers.

This principle of broad-payoff anticipatory design has guided many successful social plans. Regular task forces using systems analysis to find payoffs over the barriers might give us such successful solutions much more often. The new world that could lie ahead, with its blocks and malfunctions removed, would be fantastically wealthy. It seems almost certain that there must be many systematic ways for intelligence to convert that large payoff into the profitable solution of our present problems.

The only possible conclusion is a call to action. Who will commit himself to this kind of search for more ingenious and fundamental solutions? Who will begin to assemble the research teams and the funds? Who will begin to create those full-time interdisciplinary centers that will be necessary for testing detailed designs and turning them into effective applications?

The task is clear. The task is huge. The time is horribly short. In the past, we have had science for intellectual pleasure, and science for the control of nature. We have had science for war. But today, the whole human experiment may hang on the question of how fast we now press the development of science for survival.

From "What We Must Do" by John Platt in *Science* 28 Nov 69 (same issue as Beryl Crowe's "The Tragedy of the Commons Revisited"). \$12/yr (weekly) from: Science, 1515 Massachusetts Ave., N.W., Washington, D.C. 20005

Loose Talk 3: MOUNTAIN FANTASY



Loose Talk 2: DOPE ACADEMY

A few months ago in the Palo Alto area it was popular among some high school students to inhale hair-spray. One day at the beach a guy took a hit of hair-spray from a baggie, said "Boy that stuff comes on fast", ran a ways down the shore, and there died.

Press uproar, of course, but nowhere in any of the articles, editorials, columns, letters could you find a hint of what killed the guy. As far as a reader could tell, the boy died of bad behavior. Did the hair-spray lacquer his lungs? Does some ingredient of hairspray affect heartbeat, or replace oxygen in the blood? Should he have used the baggie differently? What brand of hair-spray was it? No information.

And that's irresponsible.

It has been asserted by many (myself one of them) that dope has its uses. If that's a promising hypothesis, then it's time to pursue the matter with some scientific rigor. And far beyond the pioneering proofs of therapeutic value and creativity enhancement of psychedelics.

Because dope lends itself to premature dogma-making, there should be several modes of dope academy in operation, say for starters:

- Ashram
- Hard core
- Pharmaceutical

The Ashram—a community of masters and students—could investigate exactly how and how not the various dopes can aid the spiritual journey. Their job includes reporting what they learn and what remains mysterious.

Hard Core means, I guess, a kind of dope survival school where a person can stick anything he wants into his bloodstream—with full individual responsibility for the consequences. If he wants to shellac his brain, that's his concern. Maybe the school would develop soul retrieval techniques, and maybe not. Its prime purpose is to discover and report the anatomy of what happens in the hairy realms of dope use: I expect the academy would draw adventurers and suicides like moths.

The Pharmaceutical academy would probably have direct affiliation with drug manufacturers. Their research would emphasize the chemical aspect of drug research, and not with involuntary mice but voluntary humans. Maybe with a pharmaceutical dope academy we could at least get some straight information on dosage and mixtures of drugs, not to mention far better designed drugs than the hodge-podge on the market now.

Of course one perfectly valid approach would be to outlaw all mind-bending drugs and force all economic and information traffic into the black market where presumably "the invisible hand" would sort the value from the valueless, the honest dealer from the crooked, and generally sharpen everybody to a fine outlaw edge. Which is the format we have now.

And it isn't so bad. Until you have been folk-lored and hyped into a buy of dirty acid, whose bumper is bitterness without recourse. Dope research does not need to be medieval.



Everybody complains about the present economic and political systems (Ours and Theirs), but I don't see many new ones being tried out. Some of the communes revisit barter and tribal democracy—which is workable only on a small scale—and that's about it.

What would be most useful is a system that generates systems, a scene whose entire purpose is to try stuff on a scale that has relevance to societies, civilizations.

Suppose a piece of property that contains a mountain valley (the fantasy could equally well be a ferro-cement island, but mountains are more familiar for fantasy purposes). It's a high remote valley with no roads into it—or any that exist are destroyed. It does have a modest airfield. To get to this place you either fly in, walk in, or pack in with animals. That's the filter. Either you have plane fare (which helps support the place) or sufficient desire to walk in. Imported materials must be light ones. Motor vehicles that cut up the land and other intimacies stay out.

Call the place Place. It is owned by the Place Company, which has ecological responsibility for the land and procedural responsibility for the fairness of what goes on.

The first action at Place is to build a big fence, not around it, but down the middle of it. The fence (unlike Berlin's) has numerous open gates, holes, tunnels, arches—a very permeable wall. A very visible wall. It defines East Place and West Place.

To reside at Place (East or West) you pay rent to the Place Company, which also determines that you don't mangle the land. The company may evict irresponsible land users. Place Company bears the same relation as referees to a football game. Their function is to keep the game fair, determine the minimum rules and enforce them minimally, and bear no alliance to either side but to the life of the game.

For game it is. Whichever side of the fence you inhabit constitutes a team which stands opposite to the inhabitants of the other side. Relations need be neither hostile nor friendly, merely competitive. And you can always change sides, provided the other side wants you.

(This fluid adversary model is the direct product of a game we played a few years ago at an event called "World War IV". There was a bunch of people in a field with a 6-foot push-ball painted like the Earth. I announced on a megaphone, "OK, there's two kinds of people—those who want to push the Earth

over the row of flags at that end of the field, and those who want to push it over that fence at the other end. Go to it." For an hour or so the ensuing battle went on with no score, because whenever the ball approached one end or the other, some of the near-victorious players would defect to the underdogs and push the game back in the other direction. Playing was more fun than winning or losing. The Earth oscillated to and fro on the field in a state of perfect dynamic equilibrium, and the game was pure delight.)

The content of the game of Place is trying stuff. The goal of each team is good works. Try different political response systems. Try different economic systems. Keep what works and go on to try other stuff. What can be done with lightweight technology to capture and employ the abundant mountain sunlight? What social forms make a most pleasant community? What education best encourages both mental balance and invention? What in fact are the most productive questions to pursue? Whatever one side tries, occurs in close view of the other, who may incorporate it or try something opposite or grandly ignore it or defect and join it, leaving a tempting vacuum behind them.

Place is remote from the world physically, yet intimately linked to it by communication. The game has access to the best of new or ancient inventions, devices, people, processes going on outside. One public service the game performs is to investigate the better integration of elements now scattered in the world as well as to generate new forms.

I assume considerable interest by the world in what goes on at Place—both for entertainment and instruction: forms which show promise in the game may well be generalized elsewhere in the world. As in other sports, the audience is one-fourth of the tetrahedral dynamic (Team 1, Team 2, refs and audience). Spectators provide the energy of their attention as well as financial energy. What else can account for the superhuman deeds of tight ends and defensive halfbacks on all those TV Saturdays and Sundays? What we're looking to do is harness that energy to the purposes of down-home world saving.

As Earth becomes acquainted with its physical finiteness, it has need of cybernetically alive systems which ensure both continuity and originality, where evolution may safely continue its engrossing play in the fields of the Lord.

Let Place be a place for macro-invention in this realm.

Game design

We are talking about how to be able to change the games that Peoples play.

The strategy of game change is: you don't change a game by winning it or losing it or refereeing it or observing it. You change it by leaving it and going somewhere else and starting a new game from scratch. If it has appeal it will gather its own energy. (Fighting a system, however, merely strengthens the system, which accounts for a lot of bitter revolutionaries, including victorious ones.)

Whatever plays the game, the game is played on the field of the physical. Mind points don't count unless something happens physically. Pain penalties are of no consequence unless something adapts physically. Move the molecules, or admit you're a spectator.

As mind grows mightier, and physicality stays what it is, the world may manifest a subtler and subtler play of elements, wielded with enormous finesse by intellection largely invisible, but ever held to this world by the mundane leash. I like the rule. (Margaret Fuller said, "I accept the universe." Thomas Carlyle said, "She'd better.")

There are lots of ways to organize social behavior. The advantage of working with games is that they are regenerative, if they work. The fun of playing sustains the game from within, from the pleasure of the players. Instigators need not be leaders; the game generates its own leadership and succession.

Liferaft Earth

The event we did recently called Liferaft Earth was designed as a game. Its intent was to make very personal the matter of population control. The stadium was the news media, so a certain amount of theater (i.e. plot) was designed in.

The few rules, announced far in advance of the event, were: a lot of people stay publicly together for a week without eating. Anybody may leave anytime but may not return; their departure is considered a death.

The bait for the media, besides the noble cause, was suspense. Who would come to the event? How many would last the week? Who would they be? What kind of stuff would go on with hungry people penned up together?

An additional unexpected question was, Will the sponsors find a place to hold the event? We went into our press conference to announce Liferaft Earth still without a site for it. [Nobody wanted the unknown in *their yard*, not the University of California, Stanford, Berkeley, San Francisco, Tilden Park, San Mateo County. Everybody loved the idea, somewhere else.] So the press conference consisted partly of us asking for a place to hold our noble event. And it went pretty well—Jerry Mander had not given much information in the press releases, so press had to come to get the news. We had some attractive names helping with the announcement: Stephanie Mills, Dr. Eugene Schoenfeld, Don Aitken of Friends of the Earth, Dr. Sheldon Margen with nutritionist credentials at Cal, and Wavy Gravy (in his last days as Hugh Romney) dressed as a hamburger. Further visual interest—useful for TV and wirephotos—was provided by Earth posters, the door for the event with its sign "Are You Ready To Die", and a splendid model of the inflated 10,000 sq. ft. polyethylene pillow that we planned to hold the event in. Even though the reporters distrusted us for not having a site, the item was carried on local TV and newspapers, and the wire services. Thank the popularity of environmental issues for that.

LIFERAFT EARTH PHOTOS BY BONNIE-JEAN ROMNEY



Under the Press Conference gun.

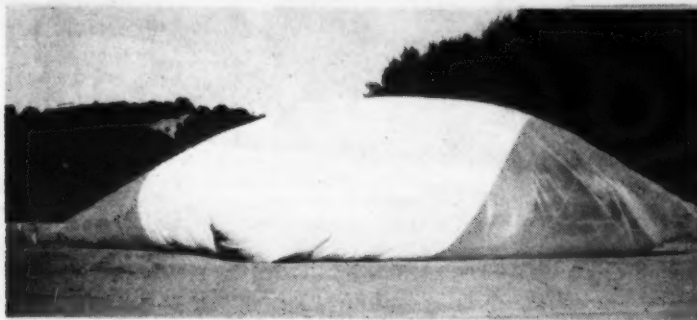

This is the pillow of 4-mil polyethylene we would have used for Liferaft Earth, except for its questionable flammability. Pillow designer Charlie Tilford wrote me recently: "I'm in the process of rebuilding the Santa Barbary inflatocomplex, to burn it down."

Site-finding was getting truly desperate when a phone call from Hayward in the East Bay came through. A guy named Bill Goetz, head of a poverty program office in Hayward, said he had seen us on Channel 2 and did we want to hold the event in his parking lot. I went and looked, and it was all wrong, too small, all at a weird angle on a hillside, out of anybody's mainstream, into a different population than us—old folks and Spanish and social workers. . . . It was perfect. So was Goetz and his staff. So, it turned out, was Hayward.

Hayward's city manager was an old acquaintance of the head of Portola Institute. That meant that from the top there was trust. We got nothing but friendly cooperation from the city fire department, police department, health inspectors, and press. After what we'd been through, Bill Goetz and Hayward had our vote as All-American City of the Year.

Who were the cast by now? Most active was Wavy Gravy, who had signified for the Hog Farm's participation way back during the summer. Now he was inviting people left and right, buying toys like jacks and plastic fruit, hustling around. Frantic work was going on by the Southeast Inflatoenvironment group (initially Charlie Tilford, by now mostly Andy Schapiro and Joe Hall)—they were building a net to hold down the vast pillow and getting kicked off test sites. Slack polyethylene burns like napalm; inflated poly doesn't: try telling that to a Fire Marshal. Dick Raymond of Portola Institute was placating our insurance company and all the others who needed hourly placation. Stephanie Mills was on her Planned Parenthood phone inviting and reassuring. Jim Burleigh of People's Architecture in Berkeley was still hoping to find a way to do it in Berkeley. Dan Rosenberg of Sierra Club, out of the blue sky had volunteered to help find a site (Dan is the model of something every business should have, a company good guy, who's paid to go out and find good that needs doing, and do it). Back East Charlie Tilford was camped in the Union Carbide offices trying to get us a pillow of non-inflammable vinyl. Bill Goetz was busily soothing the concerned environs of his parking lot.

Since confirmation of the site came only 2 days before the event, we distributed map press-releases to the media, and made them available to participants through offices in Berkeley, San Francisco and Menlo Park. The last words of instruction were:

To make the event as easy as possible on the community we're asking that participants who plan to starve-in not park in the immediate vicinity of the site. Have someone drop you off, or park a long distance away. If you are a temporary visitor, please do what you can to reduce traffic near the event. There are many people living and working in the neighborhood of the site who did not ask for a public show on their street. They deserve every courtesy.

The Hunger Show begins on Saturday, Oct 11, with the door closing on the pillow at 6 pm. Whoever's inside at that time is in the show. No one else comes in. Anyone can leave anytime (no return). Participants should have their own sleeping gear and clothing to accommodate warm days and chilly nights. No food in the pillow. There is water. Persons with kidney troubles or other ailments that might be made worse by malnutrition should skip this token famine and wait for the real thing in 1977. There will be an MD on hand for emergencies throughout the event. No children fasting please; not yet. Participants will be asked to signify a terrifying release form which signifies that you're on your own in terms of liability and that you don't mind being filmed. Regarding legal/illegal, bear in mind that you are very visible in the pillow, and visible lawbreaking is punishable by endless inconvenience. Changing that requires some other kind of event. The subject of this one is: you are what you eat.

Liferaft Earth

I'll have different conditions on different parts (vary internal pressure, airflow, applied flame, water on outside), and take pictures of it all. Trying to reconcile: 1) a piece of burning poly is SCARY 2) a lot of poly structures have held a lot of people with no disasters (greenhouses, Jim Cooks in Houston, mine). Is it luck, or is there some mechanism that makes large structures burn differently from scraps? I'm not using poly until I find out—but I want to know because it's so damn CHEAP. I'll let you know what I find."

Charlie's at Columbia University this winter. The long-haired group doing inflatable buildings, who are variously called Southcoast Inflatoenvironment Group, Southcoast All-Electric Campfire, and Pneumads, are based in San Francisco at 400 Central, San Francisco 94117. (415) 567-2659. What they're doing belongs at every public event.



Before saying how this Hunger Show went, I want to suggest what could be. Muster a travelling troupe of skilled improvisational actors and divide it into two or three sub-troupes. Set up a tour through college campuses with pre-publicity and all that. Starting on a Monday at each campus a hunger show begins in the theater, with the participants—one sub-troupe of actors and however many voluntary students from the college—confined behind chicken-wire on the stage. Let 'em starve all week, building publicity, to a paid-audience performance on Saturday night. Now the troupe cuts loose, laying in every kind of stress and issue, trying to burn or pray their way to the center of the population madness. Let whoever was the "leader" have a cowardly death and departure. Serve food to the audience. And so on. For the last day, Sunday morning, let audience in admission-free for what I can assure you is holy communion—the first food for the starvers.

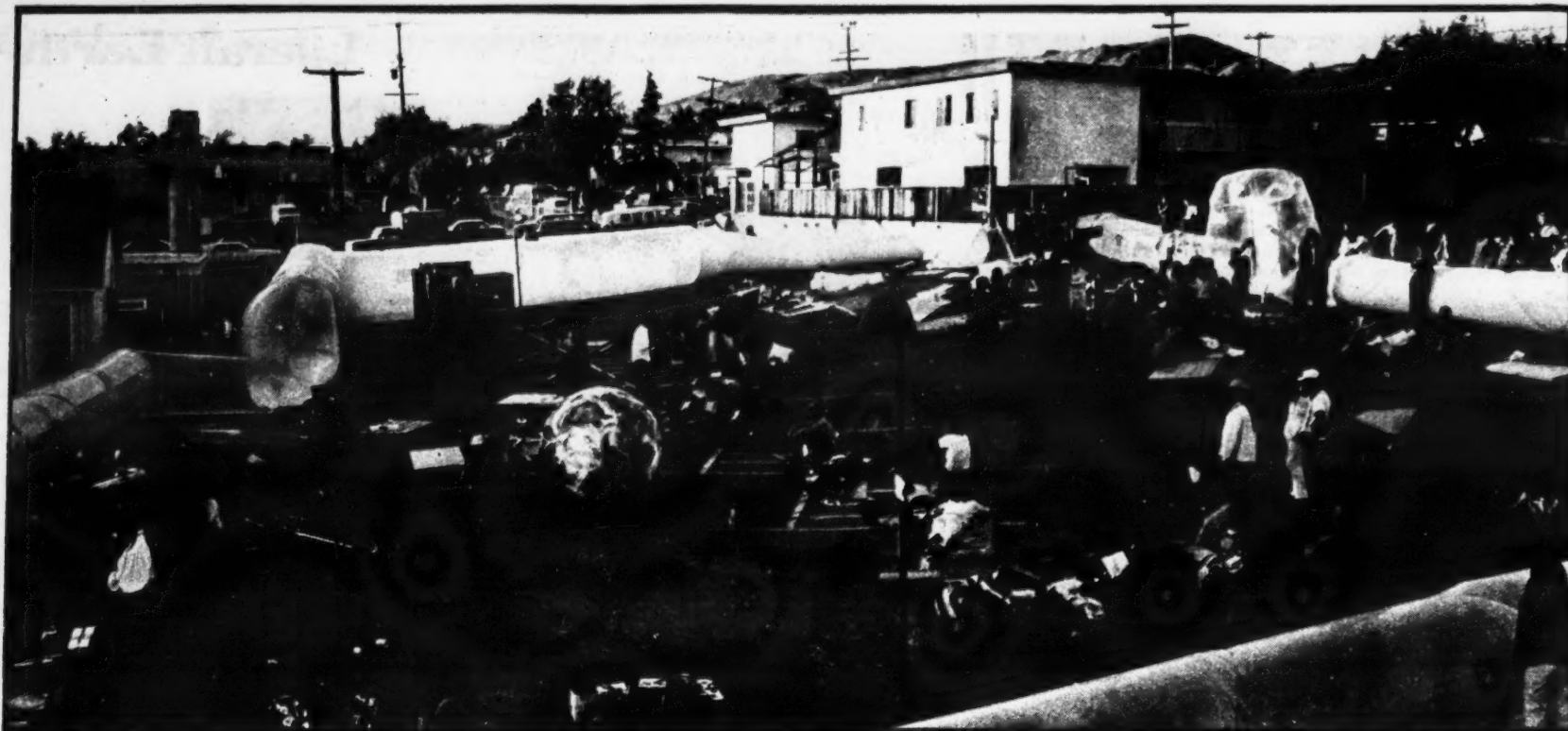

There were as many Hunger Shows as there were participants (170, counting those starving on the Hog Farm buses travelling from New Mexico during the event). So rather than try to solo a description I'd rather ride tandem with Rick Field's account and Tari Reim's mid-week report for the *Berkeley Tribe*.

From *Berkeley Tribe*, Oct. 17-23, 1969

The highly public place turned out to be a parking lot for a motel turned poverty center in Hayward, California. The Southwest Electric Campfire nomad architects circled the concrete with a polyethylene air-filled wall about four feet high. It had been planned to hold the show inside a giant space-egg of the same semi-transparent membranous material. But the fire chief declared it a fire hazard, so the wall was a last-minute innovation. Not until it was fully inflated did we realize it looked exactly like the bulging sides of a rubber raft.

Inside we had ourselves, a sound system, television, water, chemical toilets and whatever anybody brought. We flew world flags, the ones showing earth as seen from a satellite. About one-hundred twenty weighed in before the supposed one-way door closed at 6 P.M. Saturday.

People kept arriving as late as Wednesday. It was decided to let each new-comer ask everyone on board for permission to join. They spoke to us from outside the wall, using a microphone. The crew then voted yes or no, usually by voice.

No one was denied. Though a sizable minority wanted to stick to the dead-line.

The first division appeared here: some took the Liferaft as a vow, and wanted to play the game close. Others didn't like the role of insider refusing outsider; they pushed for the opening up of the Liferaft game. A familiar commune problem, population pressure, how not to close off and yet not be swamped. We, however, had enough room—at least we did as long as we stayed in Hayward. And we had no problems feeding everyone. There was enough plain water, ice, and even an occasional treat of hot water, "tealss tea." We had none of the kitchen problems of large groups. No hassles about diet, cooking, cleaning. (Though we did have our share of talk about food, especially diet.) But neither did we have the unifying ceremony of a common table.

When you don't eat you have nothing but time. One corner of the raft was given over to the technology of communication and time-filling. Running this Liferaft brain-center was our jester of ceremonies, Wavey Gravy, Hugh Romney of the Hog Farm Family.

The first days records were played whenever no one was speaking over the sound system. Imaginary, usually elaborate, meals were read for breakfast, lunch and dinner. Games were played with prizes of plastic fruit. Newscasts kept us informed of events inside and outside

← The inflated surround was a wonder. Ideal minimal barrier. A product of desperation, it couldn't have been invented better. It was pure vulnerability—you could fall over it or cut through it easy as pie. We were contained by will and barely anything else.

Signing in Saturday afternoon was a ceremony. You weighed yourself on this funky scale and signed your weight and name with a pen embedded in a plastic asparagus into a big impressive Hog Farm book. Bonnie Jean conned and supervised. This ceremony and the many others were the product of Wavey Gravy's insistence on dramatic forms, hard edges to the game. "Play hard and play fair" is a place where he lives. It can un-fuzz your mind.

A hundred or so people. It wasn't enough. We weren't crowded. (Goodbye, expectations, you never had a chance.) And we weren't reflected on ourselves; open sky inhaled everything from us. All we had in common was plastic fence, the mike and sound system, and only gradually hunger. Without the open mike the event would have been nothing. The sound system was our mutual consciousness, however cluttered.

Who was there? An odd lot. A scoutmaster and his wife, Calvino, 52. High school girls. A guy, never identified, who looked like the vice-president of an electronics firm, and made it through to the end. Ecological politicians (no offense): Keith Lampe, Stephanie Mills, Gene Schoenfeld, me I guess, others. Hog Farmers, hard core and fringe—the substance of our population (Bukovitch, Tom Law, Reno, Ruffin, Sunshine, Danny, Gloria, &&). A blind girl. The filmmakers Robert Frank and Danny Lyon. Student pres. from SF State. One of the staff from the poverty offices. Dick Raymond from Portola Institute. No narcs.

the raft. Six medical students had started fasting in Salt Lake City. The Hog Farm convoy of seven buses was on route to join. Sixty of them had begun to fast on Saturday.

We also watched a UN starvation movie on a sheet hung from the poverty center balcony, and listened to a tape of Kafka's "Hunger Artist."

The light-heartedness and activity were helpful, but beneath it all there was the growing awareness that the sound was never off. Since the raft was wall-less there was no escaping. Noise pollution of our own environment by our own entertainment. The amplification was using us more than we were using it.

Some Liferafters left because of this. But those who left without first trying to bring up the problem via the open microphone—it was there for anyone to use—did not grasp that we Liferafters could change anything we wanted to change.

Had the model of Liferaft as Earth been more deeply felt, there would have been more active caring. We create our environment. We cannot pretend the world is not our environment—an object outside—for we cannot leave it. It follows us even as we destroy it.

Thus leaving the Liferaft because of not liking its environment was like leaving the earth—an impossibility. Yet many left, giving up the game and the vow.

Quite simply, the Liferaft depended on the people in it. Some saw this. Others treated the event more passively. They came out of curiosity and stayed as long as things were "interesting." Not seeing that the "interestingness" of Liferaft depended on the people in it. Stewart Brand, the inventor of the Liferaft idea, was conspicuous by his silence. More interested in what would/could happen than in making it happen.

On Sunday ABC-TV arrived. They were filming a special on ecology activists. They were on our side. Could they film us from within?

Another division: some Liferafters were dead against mass media; they were the enemy. Others felt we could use them. Still others felt we could convert them, by being open and friendly.

The decision was to let them come in if they fasted with us. ABC pleaded. They had important work to do, useful work. They couldn't spare the time. So they filmed us over the wall. Anyhow, we had our own media inside, Robert Frank with an empty stomach filmed ABC filming us.

Since the door was closed at 6 pm Saturday, the music, the color TV, the four microphones, have been blaring away.

Saturday night, Reno-the-jacks-coach held the World Series of Jacks, After exhausting preliminary matches, Susy B, upset the much-lauded Gloria, much to the delight of Hayward fans watching from the perimeter.

← Rick, I was wasted. As much cogeny as I could muster was sliding out over the telephone lines to the reporters who kept calling. Stephanie and I were the names they knew to ask for, and whatever we said on that fucking phone is what appeared in the newspapers—it shouldn't be that way, but that's how it was, and it drained us.

It was far better with the TV people, because they had to come to the scene and would interview more people. More important, they saw us, and saw us diminish, and began to identify. That never happened with the newspapers and radio interviews.

If news is as important to social consciousness as everybody says, how come there's so much sloppy reporting? Associated Press (via phone) conjured the news that Dr. Schoenfeld was denying people aspirin for their headaches, and that fiction was printed throughout the United States. Some of the underground coverage was better, some much worse. You pays your money and you takes your chances when you read a newspaper.

LIFERAFT EARTH

With the arrival of the TV crew we felt how exposed we were. Flat parking lot concrete. Hot sun. Cameras. The good citizens of Hayward peering at us over the wall, as if they had never seen fasting long-hairs before. Some of us got uptight, tried to find a spot as far away from the eyes as possible, but finally there seemed nothing to do but become transparent, get used to it and continue living.

A question about getting high. Some people smoked grass, as discreetly as possible. For others, the paranoia level was too much—all those people watching. Others preferred meditation, yoga. The first three days we did group breathing exercises. (Meditation and yoga seemed good survival skills; it was easier to survive the noise, tension, nothing to do time; it gave moments of solitude in a week of constant social living.)

Truly, The Eyes of Hayward were upon us. But it was all right. Most spectators had never had the chance to observe tribal ways so closely.

The transparency phase didn't last long. Kids invented the game of punching holes in the raft. A Hole Patrol was armed with tape. It became clear that most spectators didn't know what we were doing. Some Liferafters wanted to go outside the wall and talk to people. Some wanted to let spectators wander around inside. Most of us felt exposed enough. Again, the open/closed division. Gandalf said, If you can't get through to people over the wall, you can't get through to them outside it. The end result was that more of us spent more time in communication yoga, rapping with spectators over the wall.

It was twenty-four hour parking-lot theatre; the main action was not eating. Suspense was supplied by how long we would last. It was hard for many spectators to see the connection between our "game" of not eating and getting along with each other and our "message". It was hard for some of us to see the connection also. Anyone who didn't was welcome. And some came just to fast, as self-purification, as a joyous, positive act. To some the link of fasting to starvation ecology politics was a bring-down.

The political/spiritual dichotomy was always present. Yet for many of us it was not real. Some learned what it was like to fast; some learned what it was like to be hungry; most of us learned both.

Fasting to get high, to purify, to understand the root fear of infant helplessness when the breast did not come on time; did not cancel out fasting to know hunger, to call human attention to present and future starvation of food and space and silence.

"Political" and "spiritual" were not only not mutually exclusive. They were mutually interilluminating, as interdependent as the life-support system. The Liferaft experience was a continuum, a sliding wave-length between the two conceptual extremes.

In case there's some question what Liferaft Earth was about, it was about this



Tom Law and Reno led the yoga breathing exercises. It meant a lot to do something with the body that was growth, not further shrinkage. We were doing something in unison, and that meant a lot.

On Sunday, the crew built a swimming pool and we spend the day lounging in the sun at our microcosmic Country Club.

The following day remained cold and cloudy and the crew kept warm with football, frisbee, flying kites, darts, and yoga.

We also tried a Hog Farm specialty, the Gong-Bong. A group of people get in a circle, hold hands tightly, then squatting, breathe deeply 14 times. Slowly stand up, raise your arms, holding the last breath. Then let out any sound that your lungs make. It's a very strange high. I fell to my knees dizzy, the dude next to me passed out.

Then, gong-bonged, we stayed in the circle and the microphone was passed around for each person to say who he was and why he was on the Liferaft. Wavy's right: this should happen at every event where people are staying together. What people said was strong clear stuff. By the time the mike came around I had to talk through a considerable lump in my throat.

By the second night crew members were asking other crew members for permission to leave the raft, keep the fast on the outside, and then return. By this time we had evolved a method of decision making: we would make no decision about future policy. Leave if you want and ask for permission to re-enter when you get back. In practice, people left and came back without much trouble. Maybe five, give or take a few. But there was a growing group feeling that people should not leave and then return because it was becoming clear that the difficulty was not only fasting but staying in this often insane place with the same people. (Most of us had not known each other before. We ranged from age 16 to 52, from scoutmaster to beyond description.) What it came down to was, if you felt people shouldn't leave, you didn't leave.

We were not in a beautiful spot. We sat, walked and slept on concrete. Longing for trees. Calvino talked about organic gardening. Maybe we could bring some earth into the raft. At least the sky was there, if you lay back.

Hayward was the kind of place you get marooned in while hitchhiking. Cars slow down just to look at you, never to stop. But as far as the ecological consciousness of Liferaft—it was perfect. A hungry crowded concrete future. And the people could step right up and see it, for free. It was also good for us, to be out there in the middle of parking lot shopping center america, talking to people far from hip ghettos. It was intensified by that empty spaced-out lighter than air feeling of hunger. And it was funny, how many of them were impressed by our not eating. We were Fools but we were doing something that was beyond them. Some heads got opened. Not making a big serious deal of fasting was our best Fool's way. We gave the microphone to somebody munching a hamburger. Spectators—a few—wanted to know what they could give us. Since food was out there wasn't much. Some of us struggled through Ehrlich's "Population Bomb", to know what we were talking about. (It was hard to read after the second day; eyes kept slipping off the page.)

Rain clouds on Tuesday. We inflated our common shelter—a smaller version of the original space-egg. A warm drowsy secure nest. But it was called a fire hazard, even though it was raining. Soon we had a shanty town of scrounged plastic and wood lean-tos. Private property. The common one-sky-one-roof feeling disappeared. Small groups invisible behind their plastic. No longer could you spend time just drifting around the parking lot, bumping into people, picking up on what was happening.



[photo: Oxfam]



Tuesday, getting bleak.

The rain that night was just too heavy. We found shelter in the poverty center office. People and sleeping bags soaked through. Started the morning with chanting. Rain continued. People left. Report that Liferaft was sinking because holes could not be patched because of wet plastic. Report that a stop sign had been thrown into Liferaft during the night. Decision to abandon Liferaft—we couldn't stay in Center office—and continue Liferaft in back room of Whole Earth Truck Store. (No place else to go.)

Many of us left during the move. Everytime condition/place changed we lost people. Keeping open to moving and change was harder than fasting for many. We were wet, tired, funky. The room was warm and dry and much much too small. We covered the floor with dry sleeping bags and the walls with wet clothing. Again, the model of a crowded hungry future, too many people living in insect closeness. Of course for a while it was nice and cozy, close comfortable groups laying around, taking it easy. But the TV in the corner reached every ear. Cries of Turn it down. Cigarette smoke duplicated L.A. air. Many, able to stop eating, were unable to stop smoking. If you took a step, you had to step over somebody. After a few hours of this more and more people died.

A general goofy punch-drunkenness. Some avidly read cookbooks, especially savoring the big glossy illustrations. A TV crew arrived. Wavey Gravy passed out all the toys he had left. During an interview with Brand some crew member blew bubbles in front of the television camera.

We took stock. The three days in Hayward were over. We had plenty of publicity—the news every night, talked to too many reporters. Now when TV or radio men came most people hardly stirred. Nor was there much interest in watching ourselves on TV. The Log was hopelessly out of date since people were leaving without bothering to weigh-out.



Roy Sebern, artist.

With the sky gray and threatening, like a scene from the Old Testament, with the fourth day of hunger producing weird and mellow hallucinations, the entire Liferaft Earth seems more surrealistic and more absurd.

But sitting here, looking out across the "Hunger Show", sitting here in Liferaft Earth looking across the desolation of this Asphalt-Parking-Lot In-Hayward-Wasteland, I can still remember that this macabre and absurd scene does not surpass the outside world I came from.

Tuesday night. The rain kept coming down that sloping asphalt. ("No rain this week" the weather bureau had said.) People were 3-days weak and now were soaked. ("Two more days of rain" the weather bureau said now.) The Pneumonia Show. I started waking people up and sending them into the plastic tube—it wasn't dry enough, and the Fire Department would chase them out. We'd have to leave the enclosure. I stood by the door "ARE YOU READY TO DIE" for two breaths, and pushed on out. The key I had to the big building didn't work; I called Goetz and he came down to open his office. Warm dry office, gradually filling wetly with people. Wavey comes in. His wife Bonnie Jean comes an hour later nearly hysterical; she's been searching for him all this time in every pile of junk in the enclosure. I go back out to get the final refugees. Rain and wind. What I hear, walking through the debris, is "This is the way the world ends... sooner than expected", only not that dramatic. Just a caption.

It was impressive, that people as weak and fucked-up as we were could clean up the parking lot and move out so efficiently. We kept discovering that, how as you get weaker you still can do what you have to, only you do it better. You get kind of simple-minded, I think. It makes for good press interviews: you're too weak to tell anything but the middle of the truth.

Robert Frank stopped by to tell us he'd died driving over from Hayward. He felt the movie he'd been trying to make had been in the parking lot. If we'd stayed there, stuck it out... He obviously didn't feel too good. We'd watched his last movie, "Me and My Brother," starring Julius Orlovsky, in Hayward, projected on a sheet; it was depressing to lose him.

The seven Hog Farm buses arrived that night. Painted with "Liferaft Earth Hunger Show", driving from New Mexico through breakdowns and hamburger highways. It was now Thursday. Sixty or so had managed to stay alive, driving, feeding kids. Others hadn't started the fast or had died along the way.

Back in the Hayward parking-lot—hearing that they were now in Reno, that they had to fix a clutch in Las Vegas—we had talked of the energy we would receive when they joined us. How beautiful it would be. The vision of sixty more Liferaft people coming as our numbers dropped.

But we did not run out into the rain and embrace them. Instead we stuck stubbornly to our remaining structure—probably because it had in fact fallen apart and we were doing our best to keep going. But we went through the whole trip of our game: Stop at the door, are you alive or dead, weigh-in, and so on. One by one. Since many Hog Farm people were dead, having eaten, and needed to get out of the rain, see friends, dry off, stretch, use the bathroom—the game at this point was just in the way. Living and dead from the Farm all

had the same living problems. The pure Liferaft of only fasters was, by necessity, a thing of the past. But we held on tight to our conception of what we were doing; or our conception held on tight to us.

Understandably, many brothers and sisters from the Farm were unhappy. Thoughtlessness and our weary apathy were received as negative vibrations. Farm people felt a come-down from their cross-country bus-life Liferaft. Not that it was all bad. A lot of what happened was just fine, embraces, smiles, sharing. But there were just too many people in the room. Kids and dogs running around. More people kept coming in to the room from the buses. Before our eyes our population exploded. Out of overcrowding, misunderstanding. Arguments over the microphone. Some trouble within the Farm. Somebody wanted to discuss the wording of the original Hunger Show leaflet. Finally twenty-five of the newly arrived Farmers walked out and died across the street in a Chinese restaurant. Wavey Gravy, torn between communes, said he was leaving because so many of his family were leaving. He looked miserable. Somebody said, But you can't go, weren't you one of the organizers. Somebody answered, That's the trouble, there aren't any organizers, it's what all of us do.



Wednesday, the full catastrophe.

At this shock-point one Hog Farmer took the microphone, and said, Listen, I have this book, you ask it questions, and there was suddenly instant agreement. Bring in the Book of Changes, to help us through our changes.

A call for silence. People meditating, going into themselves, quieting down. We passed the bundle of yarrow stalks around. Over ninety people touched them, held them, heavy with potential. We all placed our hearts in the straight-crooked stalks, falling apart, coming together. Intense highly charged stale late night air.

"The Arousing: Thunder repeated: the image of shock. Thus in fear and trembling the superior man sets his life in order and examines himself." Changing to The Receptive: "Since there is something to be accomplished we need friends and helpers in this hour of toil and effort... to find friends means to find guidance." The words flashed away our weary collective stupidity. There was no discussion afterwards. The whole room began breathing normally. Wavey Gravy took to heart the section dealing with the leader, that "... this is also a time of planning and for this we need solitude... In this sacred hour he must do without companions, so that the purity of the moment may not be spoiled by factional hates and favoritism." Wavey Gravy returned to his air mattress and announced that he would not speak until the same time tomorrow. Thus he signed off.

The police in Menlo Park also thought the Truck Store was overcrowded. Our third and final move was to a house in the mountains. It seemed a reward for going through all the rest. Walking through the forest, under clouds, pine-needle ground, hunger-sharpened taste buds feasting on fresh air, remembering I haven't been alone since the fast began. Please, People, let there be trees and space enough for space.

LIFERAFT EARTH

The scene Wednesday at the Truck Store was harrowing. This was my most protected research haven. With wall to wall people in it I was flat freaked. Now we were reflected on ourselves. "This is it", said Wavey, "This is the 21st Century." With the arrival of the Hog Farm buses that night (still raining), it began to get really interesting—jammed with people now, and tempers rising and procedures fraying: everything from this point on is news because nobody knows what happens next. We never found out. A long slow reading of the I Ching put everybody to sleep. The next morning Menlo police came and said to leave. That was a strange scene. I was in the parking lot of my own store raving at a cop, wondering if I was going to slug him. He was no polite cop and I was no polite citizen. I didn't hit him, but was going to do it in the press, when Dick Raymond (who'd left and eaten, because of a death in the family) came up with an original thought. Let the cops be. Hippies against cops is a boring and useless story. Go to Portola's place in the mountains, Ortega Park, and don't tell the media where we're going. Keep the fast, but get some rest. And that's what we did. A reporter from Channel 7 said as we departed, "Is there anything else I can do for you, besides leave you alone for a few days?"

All of us are here. The Hog Farm, fasters as well as non-fasters, visitors who can find us. Robert Frank returns, asks to rejoin, resumes not eating, and brings out his camera. All Structure has disappeared. No games, no news reports, no hard and fast line between living and dead. Energy comes for clear headed moments, then evaporates, then returns. Non-fasters cook elaborate meals constantly. More people die due to proximity of food but most of them don't leave. Someone proclaims, "There is no difference between the living and the dead." A comfortable wandering chaos. One radio station reports we've given up, another, closer to the truth, says we're in hiding. We wait and take showers. Wavey Gravy, in all day silence, covered with balloons, ceremoniously presents a glass of water to everyone as they arrive from the Truck Store.

Thursday, Friday at Ortega. People who had "died" were cooking constantly in the kitchen, eating four or five meals a day in front of close friends who were starving. They weren't doing it meanly, more as if with so much hunger around, someone had to do a lot of eating. I have a feeling that this is happening in the world—under-eating in one place matched by over-eating in another to compensate.

The return of Robert Frank and Danny Lyon. "I woke up this morning," said Robert, "and I felt terrible. I had to come back." Danny commented, "I'm glad Robert had some food. He couldn't carry the camera any more." During the week Tom Albright had an article in the San Francisco Chronicle about Robert's involvement in the Hunger Show, titled "One Man's End to Cynicism."



Friday, final meeting on the final issues.

We meet and try to discover an end to what had a beginning. Survivors decide to all sleep upstairs, then break the fast together. Press is invited. People give up their fantasy dinners and agree to break fast on stewed tomatoes with a little salad later, as suggested in a book.

Frank takes movie and tape snapshots of all survivors; some speak; some just look into the camera.

Sentient beings are numberless, starving and driven mad by over-crowding; vow to save them all.

A vow is making a choice not to choose at each changing moment whether to stay or not.

Survivors took the experiment as a vow.

Here Liferaft opens out, game into world. Because there is no denying the vow of birth, of living with this world; it follows us where-ever we go, what-ever we do; there is no other choice for living because there is no other place to live.

The TV newsman said, "Well, now that you've made it through this week and I see you're having some food, how do you feel?" The same guy who answered with a simple heartfelt murmur, "This is Christmas," was the guy who had nightmares for a week that the Hunger Show was continuing, and that pale and painful. That was me. That was my end of it.

The one Richard Brautigan saw happened back on Wednesday, around noon, after everybody had taken their sopping gear and split to Menlo Park. Brautigan surveyed the empty parking lot with its smelly outhouses and outline of deflated plastic. He poked around in our tidy pile of trash, noted the abundance of children's toys. He stood by the still-standing doorframe and listened to the sound of the rain on the plastic. While every so often the are-you-ready-to-die door swung slowly open and blam shut in the wind.

Fasting at Ortega was simple: endurance. Bonnie-Jean was now unable to walk, and Wavy carried her from room to room. Tom Law and Reno were hustling around organizing their Sympowosium. "The yogis," said Bonnie-Jean, "are man-mountains."

Friday afternoon was a big last meeting, partly on Hog Farm business, partly Hunger Show. Wavy was making his farewell address to the Hog, signifying a new period for him of "fast yoga", on one quick bus, next destination the Chicago 8. For the Hunger Show, it was finding a way to bring a loose show back together and end it formally Saturday morning, on schedule.

Saturday morning, the first bite of food—a squeeze of lemon, some avocado, stewed tomato—went off like fireworks in the body. Everybody's smiling, everybody's chewing. We had a kind of diploma printed up for those who made it through, and people are signing each others diplomas like high school yearbooks. "Best of luck in '69. Patty-cake."

Who are the survivors? Gandalf is manning the logbook and the scales and has the total: 52 survivors. Quite a crew. The hairiest and quietest of the starters. Lot of girls. Roy, Calvino, Rick, Amy, Wavy, Bonnie-Jean, Ruffin, Tom, Reno, Steven, Marsha, Peter, Jim, Bob Redhat, Dick Duncan, Tim, Buffalo Bob, Gil, Eban, Jerry Lamb, . . . roll-call of the living.

Liferaft Earth Cost Pie

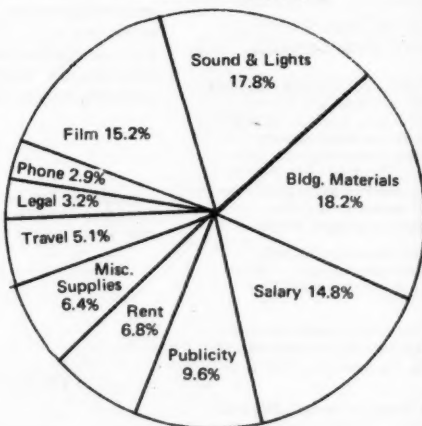

total cost \$2357.61
no income paid for by customers and subscribers of Whole Earth Catalog

Saturday, Pigasus, Wavy Gravy (scrawny gravy—down 20 lbs.)

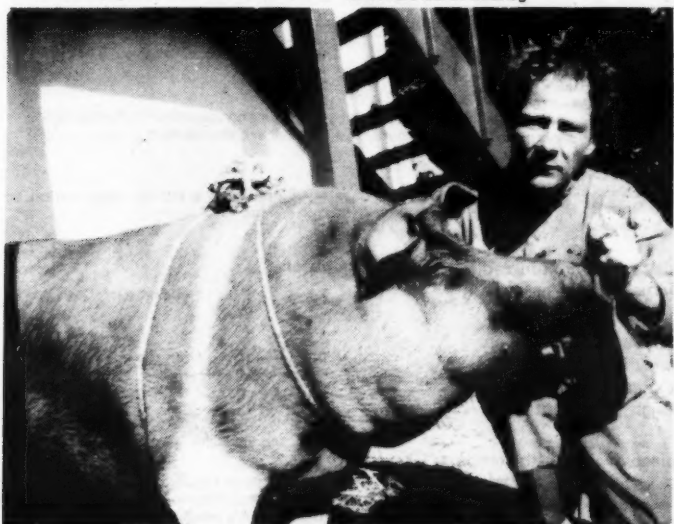

My mother is right, at last at last
So Eat! Eat!, so fast & fast
In India, China & Peru
The last meal has got to be you.

DDT & a BM
The teeth of reason grind again
Fuck no more for heavens sake!
Save the world from the old fuck quake.

\$1.10 & I'll make you sterile
Get your rocks off the moon
(balls of beryl)
Kids are made by fools like me
But only the pill can make you free.

Man is a mucker (Cain mucked Abel)
Don't throw your beer cans under the table!
God's in his penthouse—all's right with the world
He's got a Dispozall for all things soiled.
Make room for God! (Heah come de judge!)
In a crown of garbage, with a scepter of sludge
Man the mucker at his right hand side
And Dr. Filth his sinister bride.

Envoi:
Breathe while you can & fuck while you may
Species pass another day
Yez dont take yer choice so yez pays yer fee:
The earth a desert & death home free.

—Tuli Kupferberg
From "Earth Read-out"
439 Boynton, Berkeley 94707



Population Bulletin

Population bibliography

A thorough annotated bibliography and sourcebook on population (51 pp) is the Nov 69 issue of Population Bulletin, \$5/yr (bimonthly) from:

Population Reference Bureau, Inc.
1755 Massachusetts Ave., N.W.
Washington, D. C. 20036

Abortion

Association to Repeal Abortion Laws
P. O. Box 6083, San Francisco, CA 94101
Phone: (415) 387-6480

How to Obtain the List of Abortion Specialists

We will be happy to send you the List of Abortion Specialists upon receipt of a five dollar donation. At one time all information was given at no charge, but it has become difficult to cover the expenses of our organization, and we are forced to request donations. Money orders should be made out to ARAL. Please avoid sending personal checks. The Lists are updated constantly as new data reaches us.

Abortions can be obtained through the 6th month of pregnancy. Please state length of pregnancy if over 10 weeks. Mail should be addressed to our Post Office Box number. Please allow 4 days for the return mail to reach you.

Prices for abortions from the specialists on the List range from \$200. to \$700. A higher price does not indicate a "better" abortion. Specialists are located in Mexico, Puerto Rico, and Japan. Also listed is a consulting service in New York City which does some referrals in that area. Prices for such abortions are unknown as yet.

If you wish to visit our office to obtain the List, we request, in addition to the \$5. donation, that

you volunteer 2 hours of your time in advance to assist with the ever increasing load of work. The office is located at 30 Clement in San Francisco, near Geary between Arguello and 2nd Avenue. Office hours are:

Monday	9-7 p.m.
Tuesday	2-9 p.m.
Wednesday	9-7 p.m.
Thursday	2-9 p.m.
Friday	9-3 p.m.
Sunday	1-7 p.m.

Volunteers are always welcome. We are constantly swamped with work. The office is closed at all hours other than those listed above unless you have a special appointment.

Attention

Telegram money orders must have a return address so we can send the List by return mail. Send to 30 Clement Street, San Francisco, CA 94118

Men coming into the office of the Association to Repeal Abortion Laws must be accompanied by a woman. The involvement of women is important in the act of repealing abortion laws. In this way our society will arrive at a realistic acceptance of abortion as a practical form of birth control.

It is necessary for us to request that all who come to the office for a List must be willing to put in at least two hours of volunteer work at the office.

Sterilization

Association for Voluntary Sterilization, Inc.
14 West 40th Street, New York, N.Y. 10018
524-2344

The Association maintains a register of more than 1,600 physicians, scattered over the United States, who have expressed their willingness to cooperate by accepting referrals of patients desiring to be sterilized. The final decision, of course, lies entirely in the hands of the patient and the doctor. About 10,000 such referrals have been made of men and women who have come from all fifty states, the Philippines and from South America. In suitable cases the organization pays for the medical expenses involved, especially if financial need is the one factor preventing the sterilization. Many of the referral physicians contribute their time and make no charge for sterilizing indigent patients. The Association has grown to the point where it has over 2,000 contributors and a constituency of about 20,000.

Arthur Godfrey has had a vasectomy (the simple male sterilization operation), a deed with its own machismo.

Free some land, and not just a little

Get everybody who's interested to contribute a dollar and we'll buy a huge piece of land and make it a park. Not a national park, but a Peoples Park, and we'll have a big Earthwarming to greet the place and thank the place and start getting acquainted with ecological responsibility. (Send your dollar to Earth Peoples Park, P.O. Box 313, 1230 Grant Avenue, San Francisco, CA 94133.)

You've had that idea too, right? And here it is, under way. The power of the idea is that everyone has had a piece of it by themselves.

The threads that mingle in this particular manifestation practically define a people. The Earth Peoples Park idea originated largely at the Symposium organized by Tom Law in New Mexico last November, (Tom Law—his thread goes back through Hog Farm, whose bus was begat by Kesey's bus, whose motion came out of Kerouac's perception of Neal Cassady's. Then there's Tom Law's yogi thread, which disappears immediately into India.) The symposium brought together organizers and promoters of festival events, particularly rock music events. (That thread came jubilantly direct from Woodstock, Monterey Pop Festival, and on back far and wide through the various bands into the changes and judgments of all us record buyers.) The specific land fantasy owed much of its confidence to Libre and back through Libre to Drop City and to the land hunger of New York artists. The Peoples Park concept, of course, arose from the Berkeley saga of that name, and back through the whole Berkeley story-book. The commitment to ecological responsibility has grass roots everywhere, though clearly much is owed to Gary Snyder (Alan Watts, Zen Buddhism). Well, draw your own genealogy of the event; you're in there several times over.

I was sucked into the scheme by Wavy Gravy (of Hugh Romney fame) and Milan Melvin, who invited some of us to attend a meeting at the Committee Theater in San Francisco, Saturday-Sunday, Dec. 20-21, 10 am-6 pm. Roy Sebern and I went.

Roy said it looked to him like a meeting of businessmen gathered to discuss business. I felt I was at some peculiar purposeful party with a lot of theater people. (There's Cass Elliot, there's Leigh French, there's Paul Krassner, there's David Crosby, there's Mimi (Fariña) Melvin. . . .) At the same time it was something surprisingly solid. People who had cooked at Woodstock, put up an overnight sound stage at Altamont, survived Liferaft Earth, doctored with the Hog Farm, built domes and tilled ground at innumerable communes, dodged tear gas cannisters, smoked dope, been busted (there's Ken Kesey), learned some yoga, fretted about their food, travelled a lot and knew one another pretty well by now. It was no comprehensive gathering, but a good representative one for this particular subculture (Woodstock Nation?)

A number of practical things were done periodically to bring the group of 100 or so together: breathing exercises, everybody take hands and make the sound that comes, vegetarian lunch together, people stand up who have something to say and they start their remarks with who they are and what they're here for. The exhausting disputes also served finally as coherers because the idea and the arguers survived them together.

The organizers made one master stroke to surmount the inevitable hassles. They prepared in advance a well-written beautifully illustrated document spelling out the idea. The sheer materiality of this document invariably helped the idea prevail against vague challenges.

The organizers also made one large mistake (a fine, educational one). By arranging for two days of meetings, they built in anticlimax and extra dispute. The high feeling and faith built on Saturday had nowhere to go but down on Sunday when new arrivals raised the same arguments that had been gone through and settled the first day. It was a 24-hour generation gap, with the 2-day guys uneasily defending the policies of the past against the raucous impatient new-comers.

The major issues were two, with a lurky third behind them: 1) Land Fantasy vs. the Movement. 2) Ecology vs. Festival. [and 3) the use of common].

The Movement was represented by one black guy, who stood, gave his credentials, and said how he thought that the Earth Park idea was nice, but it was running away from the real problems of hunger and oppression; the only people it would be good for was a rather privileged few. His statement was followed by an awkward series of heartfelt replies asserting that No, no, the Movement was part of it, the Park would be for anybody, and it would explore alternative modes of land use which could well lead to a better-fed relation of people and land. The schism grew.

Paul Krassner stood up. Instead of emphasizing the differences of the Longhaired and Black tribes, which was the engine of the dispute, he told anecdotes of his

adventures on the borders between the two territories such as a mutual acid trip with a leading Head and a prominent Black militant. The militant gave him reason to believe that picking up the gun for protection of others was a responsible act. And the Head equally convinced him that "It's bad karma to even have a gun" Then Krassner unleashed his band-aid: "The sense of responsibility. That's the bridge. People are responsible for each other."

Milan Melvin said that a lot of things need doing. "If we can pull off one project, then we can pull off any project."

The Movement issue did not come up seriously again, but Ecology was a constant hassle throughout the weekend. The focal vocal conservative was Keith Lampe, former Yippie and present operator of an ecological wire-service called Earth Read Out. He and others insisted that a festival on the land next summer would not warm the land but ruin it. Furthermore, hot use of media was unecological. And doing just one Park was a national rather than land-related approach; there should be lots of regional Parks instead. As organized, the Earth Peoples Park looked like a giant rip-off of land.

The organizers replied that purchase of the land would be accompanied by a thorough ecological study and the basic guidelines for use of the land would be ecological ones. But the argument kept simmering and came up fiercer than ever on Sunday when votes approving the basic plan had already been made and the meeting was supposedly going into operational matters.

Voices were getting strident when Wavy Gravy stood up and waded into the rift with a dazzling tongue dance extolling the readiness of people to be careful of land. It was a sky-blue rap, more rapid and dense than the mind could follow, quick-song of tumbling images, ending "It ain't gonna be popcorn and chewing gum. It's gonna be a consecration of the land. Maybe we're gonna play softball, but people will slide gently into home."

Slide gently into home. During lunch several people asked me where I was on the ecology issue. I said that I loved the Park idea, that I studied ecology in the late fifties and as near as I could tell there are hardly any ecologists yet, at least of the kind we can use. Either they are academic and remote, or fine naturalists committed strictly to observation, or romantics still talking as if Man and Nature were distinct, only now it's Nature who's good and Man who's evil. The kind of ecologists we need, I said, can best come out of scenes like Earth Peoples Park, where young guys can make real mistakes with real land in undiluted responsibility for the consequences, good or bad.

The issue which was not raised at the meeting, which will surely be met on the land, is the toughest of all: the use of common. Garret Hardin calls it "The Tragedy of the Commons" in *Population, Evolution & Birth Control*—

The tragedy of the commons develops in this way. Picture a pasture open to all. It is to be expected that each herdsman will try to keep as many cattle as possible on the commons. Such an arrangement may work reasonably satisfactorily for centuries because tribal wars, poaching, and disease keep the numbers of both man and beast well below the "carrying capacity" of the land. Finally, however, comes the day of reckoning, i.e., the day when the long-desired social stability becomes a reality. At this point, the inherent logic of the commons remorselessly generates tragedy.

As a rational being each herdsman seeks to maximize his gain. Explicitly or implicitly, more or less consciously, he asks: "What is the utility to me of adding one more animal to my herd?" This utility has two components:

1. A positive component, which is a function of the increment of one animal. Since the herdsman receives all the proceeds from the sale of the additional animal, the positive utility is nearly +1.
2. A negative component, which is a function of the additional overgrazing created by one more animal. But since the effects of overgrazing are shared by all the herdsmen, the negative utility for any particular decision-making herdsman is only a fraction of -1.

Adding together the component partial utilities, the rational herdsman concludes that the only sensible course for him to pursue is to add another animal to his herd. And another; and another. . . . But this is the conclusion reached by each and every rational herdsman sharing a commons. Therein is the tragedy. Each man is locked in to a system that compels him to increase his herd without limit—in a world that is limited. Ruin is the destination toward which all men rush, each pursuing his own best interest in a society that believes in the freedom of the commons. *Freedom in a commons brings ruin to all.*

—Garrett Hardin, *Population, Evolution, and Birth Control*, \$2.95 from W. H. Freeman & Co. 660 Market St., San Francisco, CA 94104

It brought ruin to the Haight-Ashbury and to innumerable hopeful communes; it is the single largest threat to Earth Peoples Park (and to Earth).

The nub is self-interest. I learned from student negotiators at San Francisco State that self-interest is everywhere (especially in those who deny it), it's real, and it's all right. It's life wanting to live. You can design your solutions through it.

Earth Peoples Park can be a lab, a piece of the Earth standing for the whole of it. Can we design a way to use the Park without killing the Park?

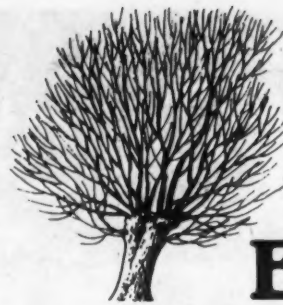

Earth Peoples

There are a few avenues that look promising. (American Indian procedures that worked in low population density are probably unworkable now). One avenue is vaguely recognizable as "enlightened self-interest", subsuming self-interest to Self-interest. (Hey, why have mystics been so often irresponsible in their handling of worldly affairs?) This may be represented in mathematics by the recent solution to Prisoner's Dilemma—an old you-try-to-win-I-try-to-win-we-both-lose matrix game. The solution is meta-game strategy. [Would somebody who knows about this stuff write in some detail what application Prisoner's Dilemma has to the Park? How about non-zero-sum games?]

Maybe the technique is identification. You're you, and at the same time you're the Park, and the Earth, now act accordingly.

We could poke around in theory endlessly. The beauty of Earth Peoples Park is the requirement of making ideas work on the land. "Instead of going through our lives with our teeth gritted," said one guy at the meeting, "we can try for an alternative."

(Send your dollar to Earth Peoples Park, P.O. Box 313, 1230 Grant Avenue, San Francisco, CA 94133.)

Within and around the earth, within and around the hills, within and around the mountains, your authority returns to you.

A Tewa Prayer

The Tewa World, Alfonso Ortiz, \$8.00, from University of Chicago Press, 11030 South Langley Avenue, Chicago, Ill. 60628

Flash, 21 Jan 1970: word has just come from New Mexico that a meeting between Peoples Park organizers and the Governor of New Mexico (Gov. Cargo) went extremely well. Cargo and his staff are interested in the idea and are looking for ways to help it happen in New Mexico. Several possible sites have been found and are being looked into.

Voices at the Park

Ecology and flamboyance are contradictory. It's urban technique. You'll have bad relations with your country neighbors.

What's the difference between up front and flamboyant?

Everything should stay in local rational terms rather than national terms.

If you want to talk, stand up.

There are a million problems and million mistakes that can happen on that land. It's an experiment. If it doesn't work out, fuck it. That community is going to have to work it out for itself. We can't tell them now what to do.

For me to become ecologically a know everything that relates to

We're all test tubes.

There'll be no peace, brother. That is a fact.

There's been a tremendous amount of eloquence here. And I think we should stop.

Because we're going to do this the only thing we're going to

I'm a double Virgo, & I'm for organization.

What we need now is about an option on the land.

We are the media.

Let's let everybody get a piece of the faith.

The only thing I've heard from the ecology people I recognize in the room is fear.

We might have a flat top per internal combustion

I think it's up to us to solve the kind of problems of Woodstock and Altamont. I don't think there's any problem that's insoluble.

Everybody is a of course.

Peoples Park



The Document

This meeting was called for the purpose of gathering a forum. There are no foregone conclusions and there are no axes to grind except, perhaps, that Life is Sacred. Each of us either does, or would like to share a dream. Earth Peoples Park can be the dream—a focal point and a hope. Its reality is the business of this forum.

Everyone who is here brings specific knowledge of their part of the world and of their particular area of involvement in it. For this forum to serve us, and perhaps many others, it is essential that we all speak our minds fully and give each other access to both our knowledge and opinion. If we're going to learn, we will listen with as much care as we give to speaking.

Earth Peoples Park is obviously not just a unique festival concept—it is an attempt to make a beachhead for a new order of civilization. Or, if not new, then more an attempt to plant the word "civilized" back in the word civilization; perhaps to unearth it.

Each of us is aware of the crisis we all share. The entire planet and specifically the consuming, wasting, worrying population of the United States, is freaking and sinking into a time of turbulence that makes the real need for survival as increasingly important as it continues to appear less likely. The truth of progress reports tell their own story: Increasing poisoning and pollution of air, water, soil and food; increasing population growth and decreasing resources to support it.

Just as the need for joint, cooperative efforts increase, so do social divisions widen and subsequent fear and violence increase. This is, once again producing the classic counterbalancing growth of violent social revolution.

The picture is agonizing, and the storm of change threatens anyone who would plant a fresh seed in its midst. Then again, it might be the best time. At the outset of this gathering, it would seem unwise to assume that Earth Peoples Park must be attempted, and equally unwise to say it's impossible.

Woodstock was a moment in history. Earth Peoples Park can be the foothold for the cultural and ecological development of that moment, a permanent home for those of us concerned with living and growth.

Earth Peoples Park grew from an idea which took many forms in many places simultaneously. Essentially it was the idea of using the fantastic power and profits of rock music to free a piece of the planet. What follows is a description of Earth Peoples Park as we now conceive it, those of us who have devoted our energy toward its realization.

Earth Peoples Park is the name given to an idea and to an act of faith. The idea of acquiring and returning one small segment of Mother Earth back to herself.

The faith to believe that in an environment NOT sectioned off by nations, property, words, and political sectarianism, people can live together in peace and harmony.

This park, this nationLESS piece of Earth in a sectioned-off world, will be freed by the collective efforts of people inspired to participate in this creation of a real alternative.

Once the land is freed and the fences removed, a Festival of Life which will take the form of a Cultural/Ecological World's Fair, will consummate the Earth.

After the Festival, those who choose to make the land their home will remain.

We are working toward making this happen during the Summer Solstice of 1970.

Earth Peoples Park will be publicly initiated after the December 21 meeting with an extensive appeal through all available media (e.g. underground newspapers, entertainment and other trade papers, weekly magazines, TV network news programs and interview shows, public service announcements on AM and FM radio; in fact, all methods of exposure which will allow an accurate presentation of the idea.

This will be an appeal for each person who was at Woodstock either in person or in spirit, to contribute one dollar or more or less.

We are concerned with finding new ways to live and work together. Selling tickets to an event is an old form which excludes some people for simply monetary reasons. But more important, it perpetuates the subject/object myth, and overemphasizes the Festival. We see the Festival as only a moment in history intended to celebrate the freeing of ourselves through working together to free the planet.

Traditional methods of fund-raising usually include soliciting well known people in the entertainment field, doing a benefit concert, and then doing good works with the profits. Or alternatively, seeking large sums of money from the Ford Foundation or enlightened inheritors.

The proposed method of fund raising, in contrast to traditional methods, this total act of faith, is consistent with the spirit of Earth Peoples Park and provides the opportunity for everyone to participate equally in its creation.

These contributions will finance the purchase of a large piece of land (50,000 to 100,000 acres) and will also finance the Earth-Warming to be held on that land. Between the time of the land's acquisition and the Festival, a team of scientists and ecologists will fully investigate the land to determine its capacities and capabilities.

One million dollars will be needed for the freeing of the land itself and another half million to finance the celebration. This celebration, or "Cultural and Ecological World's Fair" will embrace all aspects of the emerging culture, giving an opportunity for architects, ecologists, doctors, lawyers, craftsmen, musicians, theater groups, farmers, etc. etc., to show their wares and exchange ideas.

Again, in the spirit of Earth Peoples Park, all participants are welcome, but we will NOT ensure the success of this event by advertising the presence of celebrities.

The land will be acquired and protected by a legally constituted non-profit corporation whose functions will be to receive all contributions, to purchase land, and handle all external legal hassles. It is proposed that the Hog Farm's non-corporation, INVISIBLE INC., act in this capacity.

This corporation cannot and will not exercise any control whatsoever over the land or its inhabitants. It has NO power to sell or rent the land, nor to tax or police the people.

The greatest act of faith required of this idea, the idea of Earth Peoples Park, is that ACCESS TO THE LAND WILL BE DENIED TO NO ONE. There is no way to predict or prevent what we might consider to be improper use of the land. But at the same time the establishment of arbitrary rules and laws to ensure freedom has historically been proven unsuccessful. It is for this reason that we feel there should be no pre-established internal structure but that any social forms develop naturally and organically.

The topic of what balance between control and freedom best serves a community is most easily determined by the nature and consciousness of that community.

However, once the land is chosen, qualified environmentalists and ecologists can pre-establish natural patterns through cultivation, construction, etc., before the land is inhabited.

They can provide information and education as to which areas are best suited for farming, grazing, housing, etc., and which portions of the land would be best left alone for watershed, hunting, solitude, whatever.

A primary responsibility of the community will be caring for the earth, and any enlightened advice in this regard can make the difference between growth and disaster.

Earth Peoples Park is the establishment of a new precedent, the offering of a real alternative for a great many people who may be bogged down and dissatisfied with their present life style.

The birth of Earth Peoples Park, the freeing of a piece of Mother Earth can provide the inspiration for others to free their piece of the cosmos. It may inspire lawyers and judges to free their courts, scientists to free their laboratories, technicians to free their crafts, or citizens to free their lives.

We might begin by freeing our thoughts and energies here and now.

PEACE AND SUNSHINE

The letter of invitation to the meeting was signed:

Bill Alexander	Buck
Milan Melvin	Edward Bear
Glenn Roth	Jon Goodchild
Bruce Gilbert	Mimi Melvin
Tari Reim	Gary Moder
Rikki Stein	Lucie Harris
Wacco (Jere Brian)	Sky Steinbrecker

at the Park meeting

What I hope this doesn't become is a business. If we get a million and try to invest it in four pop festivals to double the money, we wind up charging \$4 at the door, which is what we're working to avoid.

This is not reality yet.

local rational regional
al terms.

Everybody is looking for an idea to take ahold of. Which is why I think we should do this in a grand flamboyant way. What I want to do is get a big shiny shuck, which is the truth. You know, posters and T-shirts & yo-yos. And go around with a shiny bus like the Freedom Train used to take around the Declaration of Independence. Take around a carnival.

Your politics & how you live your life, I don't see any difference.

ecologically aware I have to
that relate to my system.

This thing is a big mirror.

test tubes

We are facing a problem on a planet level—the survival of life of any kind on this planet in the future.

My marriage broke up because I was being hostile to other people in order to please my wife.

ing to do this doesn't mean it's
e're going to do.

Get across the idea that you're trying to get food to everybody. That'll click with everybody.

Most of the people I know who are supposed to have money, don't.

now it's about \$10,000 to purchase
the land.

Going to the bands. I'm so fucking tired of that idea, & so are the bands.

We gotta do it with some kinda honesty.

Once this hits the media, the price of land is gonna double.

We're just trying to save the world.

They stopped making more land, and they're still making more people. The price of land is going up.

have a flat rule, no less than 40 persons
al combustion engine. Like, only buses.

From now until the summer solstice, energy is on the increase.

everybody is a policeman, except the policeman
course.

Everybody has to become an ecologist.

*Once our native land grew grass
and trees so very tall.
Life was so pleasant
we never thought of it at all.*

*Only the lodges on the ground,
and at night, wild animals prowling around.*

*The yap of the coyote; the squeal of the porcupine.
The chatter of the magpie. All these tell peace
is in the valley. The horses in knee deep buffalo grass.
Mountain streams full of beaver and trout.*

Contentment until it is time to pass on by.

Minerva Allen (Assiniboine) in a book of undetermined price printed by WOPAPI, 3420 Alexander Court, Oakland CA 94601. Suggested by Richard Brautigan.

Ecology

Know Your Local Polluters

and boycott the bastards. "The garbage produced by an industry is the responsibility of that industry." (Ehrlich). Individual buyers have far more control over economic behavior than voters. Regardless of how you feel about the profit motive (I like it fine), most of the polluters are bound by it, except government ones. If you hurt their sales because they hurt your air or water, then they or their competitors will do anything to get your business back. High-mindedness doesn't have to enter into it, just choice for value.

However, beware of false labeling. Ecology is fashionable, and there's a lot of pretense going on, especially in the ads. This is where the ecology organizations can be invaluable. They are best equipped to determine who the real polluters are (and who are making real efforts to clean up their cycles), and they can shout it from the rooftops.

A compendious list of ecology (etc.) organizations has been compiled by Ecology Center and Planned Parenthood:

Grass Roots
Feb. 1970; 50+ pp.

\$1.50 postpaid

from:
Ecology Center or Planned Parenthood
2179 Allston Way 482 West MacArthur Blvd.
Berkeley, CA 94704 Oakland, CA 94609

Good Housekeeping

1. Buy biodegradable soap. The co-ops do carry them—if your market doesn't, pressure them to start carrying them.
2. Save newspapers, tie and bundle for paper drives.
3. Save aluminum cans for drives. Flatten and make sure it is aluminum (soft drinks, beer). The price of aluminum is going up.
4. Walk more, bicycle and take the bus. Think twice before you drive the car. Allow more time to get to your destination. All that gas you put in the auto, goes into the air.
5. Compost or bury garbage.
6. Re-use or refuse paper bags.
7. Write on the clean side of used stationery . . . explain why to friends.
8. Plant fruit trees in your yard.
9. Any unnecessary pavement in your yard? We need more greenery . . . you know what to do.
10. Bring back the birds . . . start a bird feeding station.
11. Help organizing recycling drives.
12. Don't use DDT and other chlorinated hydro-carbons pesticides.

Cliff & Mary Humphrey
Ecology Action, Berkeley

Some questions

Who knows and will tell us which cars pollute the least? How about motorcycles? Horses? [Yep. I've owned 'em all. Only one I'd ever camp downwind of is Appaloosa. Geldings are best.]

What we need is an ecological Consumer Reports. For that matter, what is this notion "consumer"?

Benevolent Masons

I am suggesting to everyone I know that we start a campaign to return to the Standard Mason Jar for all canned fruits and vegetables. This would reduce waste of packaging I think as well as garbage.

Dildar Gartenberg
Berkeley, Calif.

Four Changes

The unerring program *Four Changes* (final draft) has been printed as a dandy poster by Noel Young of Unicorn Book Shop. The poster is available from us for the cost of postage. The Truck Store has free copies (1 per person, please); so does the Plowshare Bookstore in Palo Alto on University.

Four Changes Poster
folded: 20¢ postpaid
rolled: 55¢ postpaid

from:
WHOLE EARTH CATALOG
558 Santa Cruz
Menlo Park, CA 94025



30

Ecological deeds

Paper—Companies will purchase Newspaper (\$8/ton) Cardboard (\$20/ton) and even mixed paper (\$3/ton) They render it to a fiber state and make paper products out of it. Check yellow pages—paper, waste. Prices will vary. Consolidated fiber in San Francisco, San Jose.

Aluminum: Aluminum cans are worth 1/4¢ apiece beginning 1970. Contact Reynolds Aluminum/Hayward.

Glass: Only place I know of is near Los Angeles. 30¢/100 lb for broken glass—The Sessler Co., Southgate

Tin cans: Only place I know is L.A. Los Angeles Byproducts \$13/ton

Organic scraps can be buried to release nutrients to the soil. Good for growing things.

- Buy drinks in returnable containers
- Share a newspaper with a friend
- Have milk delivered by a dairy that supplies returnable glass bottles
- Bring a shopping bag to the store
- Give things you don't want to church groups—free stores, needy people
- Buy what you need at second hand stores
- Buy food in bulk, sharing with a group to reduce package waste.
- (All things come from the Earth. If you take something, use it wisely, then return it.)
- Use bio-degradable soap.
- Don't use plastics—they don't go away.
- Bury your remains in a paper mache coffin.

Tom Regan
Ecology Action Education Institute
Box 9334
Berkeley, CA 94709

Report from Boston

The Boston Area Ecology Action Center opened last October 20, with a shiny new coat of lime green and bright yellow paint and lots of enthusiasm behind it. As the paint becomes dirtier, thanks to city grime and air pollution, our enthusiasm and conviction in what we're trying to do grows stronger. Everyone is screaming about the man-child fucking his mother-earth. A huge anti-pollution fad has hit America and the politicians are having a great time. The appropriate commissions are being set up to "study" the problem. There will probably be some new regulatory agencies and maybe even a Secretary of Ecology. This is all calculated to make us "breathe a little easier" (as we choke to death)—the government will handle the problem.

It's an illusion, not because of what our government really is, but because NOTHING CAN BE DONE UNTIL PEOPLE BEGIN TO EVALUATE THEIR OWN LIVES AND SEE THEMSELVES DIRECTLY INTERACTING WITH THE WHOLE EARTH. The greed ethic, the all-American desire for the superfluous, will kill us all if it continues to exist.

So the Ecology Center opened. We work in two ways: 1) as a resource center and 2) as an action center. There are several tables of free literature, buttons, etc. We have a small library and a clippings file, both of which are growing steadily. These are used by students working on papers, by special interest groups, and by random people passing-by. Then there are many action groups, each dealing with a specific problem. The garbage group has been

The Tassajara Ecological Thoroughness Prize

is awarded this issue to the students at Tassajara Zen Center, who drink their dish water. When you finish eating, a little lady pours hot water into your biggest dish. You take your elegant little cleaning stick and scour the inside of the bowl, the pour the water into your smaller dish and dry the first dish. You repeat the process into your third and smallest dish, scour it, and then drink the water, which is a sort of garbage tea, tasty and nutritious.

This July Brother David was head dishwasher at Tassajara and before he left he entirely revised the washing ritual and retrained the students. Later, from his home monastery in Western New York, Mount Saviour, he sent the work foreman his suggestions for future dishwashers. They ranged from "a little vinegar in the rinse water makes the glasses sparkle" and "the cats do appreciate the milk left in the glasses from the guest table", to "We should listen to the sound of the water and the scrubbing, to the various sounds the dishes make when they hit each other. The sounds of our work tell us much about our practice . . . Most people dislike dishwashing. Maybe they can learn to appreciate the touch of the wooden bowls, the pots and mugs and everything they handle, the weight of what we lift up and set down, the various smells and sounds. St. Benedict, the Patriarch of Western monks, says that in a monastery every pot and pan should be treated with the same reverence as the sacred vessels on the altar."

Wind Bell, Fal 68; \$2/yr from
Zen Center, 1884 Bush St.,
San Francisco CA 94109

The Environment Monthly

A terse publication with some of the solidest information we've seen on environmental issues. Expensive, but worth it if you're an organization or a professional. \$35/yr from 420 Lexington Ave, New York, N.Y. 10017.



working on legislation against non-returnable bottles and cans, as well as a campaign against excess packaging, encouraging people to return it to the store manager or the company. There is a monthly craft workshop devoted to making things out of garbage and junk. The endangered species group will be picketing fur stores selling skins of endangered species. The transportation people are working with the Greater Boston Committee of the Transportation Crisis, which has submitted seven bills to legislature calling for a moratorium on highway building and using highway funds for mass transit. A group has begun research on biodegradation of pesticides and industrial waste pollutants. The Open Space Project is working on turning empty lots into small parks. A cooperative food store will be opening, featuring minimal packaging and healthful foods. Birth control training sessions are about to begin. These are just a few of the continuing projects. Then there have been special events—marches against the local power company and other obvious detriments to the environment, etc.

But the most beautiful thing about the center, and the whole purpose really, is that while people who are involved in any one project soon come to realize how interrelated all the projects, that is all parts of the eco-system, are. And most importantly, that it is our own responsibility to regard the whole earth with love and respect.

Please stop by to see us, or write. Our address is 925 Mass. Ave., Cambridge, Mass. 02139. We are usually open 10-10, seven days a week. Power to the eagles, plankton, trees, and all things.

Nan Hamilton

CHANGES 4 CHANGES

CHÖFU

I. POPULATION
II. POLLUTION
III. CONSUMPTION
IV. TRANSFORMATION

Small text columns on the sides of the poster provide detailed commentary on each of the four changes.

Annotated Bibliography

Two premises underlie this bibliography. First, man faces a survival problem, ecological catastrophe, which can be attributed to his own activities—his civilization, if you will. Second, man alone can prevent this catastrophe, but he has already denied himself many opportunities by reproducing to the point where not only is this process unlikely to be halted soon, but the pressures of overpopulation often guarantee the failure of various reform measures to stem the ecological crisis. In addition, further disaster is foreshadowed by this insane faith we moderns have in technology, a strange belief, since technology has done much to get us where we are today.

This is the "bias" of this bibliography, in addition to the compiler's own preferences. Some might object that the readings lack balance. Such a notion of "balance" seems strangely irrelevant in a grossly unbalanced ecosphere. In addition, many people are rethinking the whole subject of objectivity, since we are daily exposed to "objectively" trained scientists manipulating the objective facts of their disciplines to serve the interests of those who would most assault the ecosphere. Thus we note that recent scientific testimony stated that an organo-phosphorous substitute for DDT kills honeybees and then used this undeniably objective fact to argue against banning DDT!

There are several additional reasons why we have not included references of the apologists for ecological rape. Many are simply self-serving, although this is not always obvious to the reader. Many are simply uninteresting. And, the case for "necessary" ecosystem destruction is not only widely stated daily, it is actually deeply a part of our culture, a gross cultural imbalance. Self-serving polluters, ecosploiters (ecosploiter: ecosphere exploiter. Let it here be announced that this word is now coined) and their apologists have had their day in court.

This bibliography, then, is intended to be an educational defense against ecological assault, and we now proceed to note its real shortcomings. First, it is continually in revision and we need comments and contributions. Second, there are many important omissions simply because we are not yet familiar with all the literature. Especially in subject areas which we have not covered at all, we need help from people who are in tune with our objectives. And, rather than hold up distribution of any bibliography, we feel it is better to add subsequent material when it is finally evaluated. Third, there are probably some mistakes.

In addition to the above intentions, the works are included here according to other criteria worth mentioning. Availability is important, and some sources, while valuable, are relatively hard to find. Considerable emphasis has been given to the reference quality of the source. In any self-education process, reading material can be judged in part according to the impetus it gives to further reading. Those readings with good references are marked * by the date (or ** if the references are annotated. P means Paperback). Finally, the basic annotated bibliography is to be non-technical. Technical material will be appended, under a different organization, as it is compiled.

All references here are available in the UC Berkeley library system, with the different libraries noted as follows: M-Main; UG-Undergraduate; B-Biology; F-Forestry; Ag-Agriculture; PH-Public Health; SS-Social Science; EP-Educ/Psych; Engr-Engineering; AD-Environmental Design; MS-Math/Stat; C-Chemistry; Doc-Documents; E-Entomology; Per-Periodical Room; L-Law.

A. What is Ecology?

Ecology is many things to many people and you can find many definitions. Let us use the etymological Greek origin ECO (household) LOGOS (discourse or study) because what we are after here is an understanding of nature that sees order, processes, and interactions instead of chaos, static parts, and simple additive relationships. We intend for people to be moved into an understanding that is humble before the marvels of natural design instead of self-seeking knowledge that is exploitative. We seek an educational process that results in informed and spirited defense of the ecosphere.

Bates, Marston. *The Forest and the Sea*. Random, 1960, P** (QH541/B3; UG,B)

Bates is one of the most gifted and informed natural science writers. This book should be considered a basic popular ecology reference. It emphasizes the unity of diverse organisms, evolution, and man's role/ethics. Good introduction to tropical ecology.

Bennett, Hugh H. *Soil Conservation*. McGraw-Hill, 1939. Portions reprinted in Rodney Nash: *The American Environment*. Addison-Wesley, 1968. (S623/B4; Ag, F, UG). Chapters 1 and 2 are valuable for erosion problems, soil formation and the relation between civilization and soil.

Boulding, Kenneth. *A Reconstruction of Economics*. Wiley, 1950, P. Chapter 1, "An Ecological Introduction," discusses with considerable clarity elementary population dynamics and ecological interactions.

Cocannouer, Joseph. *Weeds: Guardians of the Soil*. Devin-Adair, 1954.

One of the reasons our agriculture, and our society, is on unsound footing is our perverse attitude about weeds and other "pests." Weeds are ecological essential plants. See also his *Farming with Nature*.

Cowan, Ian McTaggart. "Management, Response and Variety," in Darling and Milton, eds., *Future Environments of North America*. This might be termed a primer in ecological life management. Very useful perspective for understanding problems of managing diverse life systems where man is a permanent intruder and, therefore, a trustee.

Darling, F. Fraser and John Milton. *Future Environments of North America*. Natural History Press, 1966*. (HC95/D25; PH, F, ED) A very rich book—most of the authors have written unusually stimulating papers for such a conference as this. Check it out, because we will not cite many of the best papers here. Weak on population control, though.

Darling, F. Fraser. "A Wider Environment of Ecology and Conservation," *Daedalus* Fall 1967*.

This is a rather effective statement against specialization, and there are many specialists in ecology. Yet, "there is only one ecology." Also, this is a brief survey of various essential developments in the recent history of ecology.

DeBach, Paul H., et al. *Biological Control of Insect Pests and Weeds*. Reinhold 1964*. (SB975/D35; E, Ag) This is the textbook in a very neglected subject, and most of it is technical. However, chapters 1 to 5 are long but very useful semi-technical introductions.

ECOLOGY

ecology (i kol'aji) n. 1. THE BRANCH OF BIOLOGY WHICH TREATS OF THE RELATIONS BETWEEN ORGANISMS AND THEIR ENVIRONMENT; 2. THE BRANCH OF SOCIOLOGY CONCERNED WITH THE SPACING OF PEOPLE AND OF INSTITUTIONS AND THEIR RESULTING INTERDEPENDENCY. [FORMED FROM—MODIFICATION OF—GREEK OIKO (HOUSE) + LOGY] (HOUSEHOLD)

THE INITIAL "E"

LOWER CASE—TO SYMBOLIZE THE PASSIVE YIELDING OR FEMINE ASPECT OF NATURE. THE "PRIMA MATERIA" OR "NOTHING" OUT OF WHICH ALL THINGS ARE MADE TO APPEAR BY DIVISION.

environment

EARTH
EDEN
ETERNAL
EVOLUTION
ENCIRCLE
ENRICHMENT
ENLIGHTENMENT
EROS
EDUCE
EMPATY
EVE
EMOTION
ECSTASY
EXISTENCE
ETC.

THE ELLIPSE

A SYMBOLIC DEMONSTRATION OF THE TRANSCENDANT UNITY THAT PERVADES ALL DUALITIES (ELLIPSE—THE SET OF ALL POINTS THE SUM OF WHOSE DISTANCES FROM TWO FIXED POINTS IS CONSTANT.) ALSO THE FORM OF PLANETARY ORBITS. (MACROCOSM)

A SYMBOL

THE CIRCLE OR THE LETTER "O"

ORGANISM

ONENESS
OASIS
OM
OMNIFIC
OMNIPRESENCE
OMNIPOTENCE
OMNISCIENCE
ORIGIN
ORACLE
OPEN
ORPHIC
ORGY
ORGASM
ONTOLOGY
ETC.

THE CIRCLE (HINDU)

THE UNIVERSAL SYMBOL OF WHOLENESS OF HARMONIOUS UNITY—THE CENTERING OF PSYCHE WITH COSMOS—THE RESOLUTION OF ALL OPPOSITES (GOOD+EVIL= GOD/ MALE+ FEMALE= LOVE) SANITY, PEACE, BEYOND TIME AND SPACE, THE SOURCE OF ALL CREATIVITY AND POWER.

THE SQUARE

SAME AS CIRCLE BUT MORE AS CONCEPT OR IDEA THAN ACTUAL EXPERIENCE. (C. G. JUNG)

EQUINOX (ASTROLOGY)

VERNAL MAR. 20-21
AUTUMNAL SEPT. 23-24

TAOISM (CHINESE)

KNOWN YANG
UNKNOWN YIN

THE 4 ELEMENTS (ALCHEMY)

A—FIRE
E—AIR
W—WATER
E—EARTH

"MALE"
"FEMALE"

©1969 SAWYER PRESS ALL RIGHTS RESERVED PUBLISHED BY: SAWYER PRESS P.O. BOX 46-653 LOS ANGELES, CALIF. 90046

Sent by Christopher Beatty.

Dubos, Rene. "Promises and Hazards of Man's Adaptability" in Jarrett, ed., *Environmental Quality in a Growing Economy*. Dubos' most important points are that man is changing his environment rapidly, though he still has the same basic genetic structure, a phenomenon unique among organisms, and that man's adaptability is physiological and socio-cultural response to various environmental stresses. The problem is that this process is much delayed and thus is hidden from the usual cause-effect investigations. This is an important writer; consult his other work.

Elton, Charles S. *The Ecology of Invasions by Animals and Plants*. Methuen, 1958*. (QH541/E4; E, B) Elton is a pioneer ecologist of the highest standing; this book is a classic and fascinating reference and, most important, it is full of subtle and implicit commentary on man's relation to nature.

Farb, Peter. *Living Earth*. Colophon, 1959 P** Farb is a highly capable and readable science reporter. One of the best things about this book on soil environments is that the bibliography is exemplary. On each sub-topic you are directed to good annotated references ranging from popular to highly technical.

Frisch, Karl von. *Man and the Living World*. Harvest, 1949, 1962 P. Von Frisch is one of the best writer/scientists ever. This is a most interesting summary book on biology for the lay reader.

Gates, David M. "Toward Understanding Ecosystems," in *Advances in Ecological Research* 5, 1968*. (QH540/A3; B) Somewhat technical, plant-oriented, but not too heavy and a useful methodological essay.

Hardin, Garrett. *Nature and Man's Fate*. Rinehart, 1959* P. (QH361/H37; UG, B) This is a brilliant discourse on evolution in a perspective of man's future; Hardin is a controversial and always stimulating biologist.

Huxley, Julian. *Evolution in Action*. Harper and Row, 1953; Signet, 1957 P. (QH367/H82; B, UG, Ag) A stimulating book for the general reader on man's evolutionary past.

Henderson, Lawrence J. *The Fitness of the Environment*. Macmillan, 1913; Beacon, 1958 P. Discourse on the biochemical limits of the ecosphere. A classic work with some technical matter, but accessible to the lay reader.

Marx, Wesley. *The Frail Ocean*. Coward-McCann, 1967*. Ballantine 1969 P. (GC1018/M3; M) The ocean is one of the environments most essential to, least appreciated and most likely to be abused by modern man. Marx's book is a powerful and educational advocacy.

Odum, Eugene P. *Fundamentals of Ecology*. Saunders, 1953, 1959*. A standard and widely used text and reference. "The Strategy of Ecosystem Development," *Science* 164, 4-18-69.* Contains some interesting ideas for ecosystem management. Useful both for understanding some possibilities for technically resolving our conflict with nature and, more important, for understanding actual and potential strategies employed by ecosystem exploiters (ecosploiters?).

Rudd, Robert L. *Pesticides and the Living Landscape*. Univ. Wisconsin Press, 1964 P*. (SB951/R78; Ag, B, F, E, PH, UG) Written by a wildlife ecologist, its merit extends much beyond that specialty. It is an essential semi-popular/technical discourse

on ecology, pesticides, and population dynamics. A much underrated book.

Sears, Paul. "Ecology—A Subversive Subject," *Bio-science* 17-7, 7/64. (QH301/A13; B) This special issue on ecology should be read widely. Brief essays by some of the most ethically oriented ecologists.

Shepard, Paul and Daniel McKinley, eds. *The Subversive Science*. Houghton-Mifflin 1969 P* This is a strange book of readings, very hard to annotate. Check it out for yourself because it has many very interesting essays, very strong culture/ethic orientation. Beware of the weird pricing scheme, however; the hardback is the better value.

Simpson, George C. *The Meaning of Evolution*. Yale, 1949 P. Simpson is an advocate of ethics with a biological basis. This is an interesting work to that end, first tracing the history of evolutionary processes, then interpreting, then developing some ethical conclusions.

Storer, John H. *The Web of Life*. Devin-Adair, 1953; Signet, 1956 P* Subtitled "A first book of ecology," the book should be read by everyone who can read. The style is great and it is an eloquent overview of the ecosphere.

Wagner, Philip L. *The Human Use of the Earth*. Free Press, 1960 P** (HM208/W27; M, SS) This is a book of what might be called ecological geography. It seems to form a bridge between traditional human ecology and biological ecology.

Woodwell, George M. "Toxic substances and Ecological Cycles," *Scientific American* 216-3, 3/67. This is an interesting and accessible ecological lesson. Shows succinctly the scientific basis for concern about biocides and radioisotopes.

B. Are We Nearing Ecological Catastrophe?

This seems like a silly question, but there are those who recoil when the alarm is sounded and who shun knowledge about reality with charges of "extremism" or "subjectivity" and "emotion, when cool, rational assessment is called for." Well, it always makes me angry to know how long it's been since concern was first expressed by objective scientists not given to alarmism, and the knowledge that, throughout history, civilized man has always found out his man-made dilemmas too late. So the real question is: "Is it reversible?"

The survival aspect, on the other hand, is relatively new, and many of the most aware writers paradoxically seem to be overly optimistic at the same time they are painting a pessimistic picture. You will have to judge for yourself if mankind has the wherewithal to pull itself out of this one.

Anthrop, Donald F. "Environmental Noise Pollution: A New Threat to Sanity," *Bulletin of the Atomic Scientists* May 1969. (TK9001/BB, PH, Engr, M, Per) Calls attention to a "new" problem, its major sources, the magnitude of the problem (serious, much more than we can hear) and various panacea solutions.

Brodine, Virginia. "The Secret Weapons," *Environment* 11-5, June 1969. Very informative article about Chemical/Biological Warfare (CBW), agent shipments, testing, pathology and disposal. Required reading for those who think the issue is mere safety.

- Brooks, Paul. "The plot to drown Alaska," *Atlantic Monthly*, May 1965. Reprinted in William Schwartz, ed., *Voices for the Wilderness*. Tells the story about the Rampart Dam, one of our proposed contributions to the modern wonders of the world (we can't let Nasser and the USSR outdo us!)
- Calder, Ritchie. "Polluting the Environment," *The Center Magazine*, May 1969. This is a powerful blast against self-fulfilling predictions, using the ecosphere as a laboratory for experimentation, and panacea solutions in general.
- Carson, Rachel. *Silent Spring*. Houghton-Mifflin 1962. Fawcett P * A landmark book which should be familiar to everyone, now a classic chronicle of death and destruction from the biocides we are told we depend on by self-serving "experts." One of the interesting things about this book is the vituperation of many of the reviewers (in the chemical and agri-business industries, of course). This shows what happens to a reputable scientist when she lets her ethics and literary talent show too much.
- Chiapetta, Jerry. "Great Lakes—Great Mess," *Audubon* May/June 1968. A long list of paragraphs of Great Lakes gloom. Covers the problem thoroughly, though, and has some incredibly ugly photographs.
- Cole, Lamont. "Pesticides: a Hazard to Nature's Equilibrium," *Amer. Jour. Public Health* 54-1 (ii), 1964. (FA421/A4; PH) This is one of four articles in this special issue on pesticides, two of which defend biocides. Make your own comparison.
- Fisher, James and Selina Charlton. "A Tragedy of Errors," *Audubon* Nov/Dec 1967. Several books have been written about the Torrey Canyon incident, but most of the chronology of this imbecilic disaster is covered here. No commentary on the real causes, though.
- Gilliam, Harold. "Praise the Buck and Pass the Dirt," *Audubon* Mar/April 1968. An account of the rape of the San Francisco Bay by one of the bay's most sensitive and informed friends.
- Goldman, Marshall, ed. *Controlling Pollution: the Economics of a Cleaner America*. Prentice-Hall, 1967, 1967 P. This is a fairly interesting book. Among some standard popular articles, it has some useful reports on pollution experiences in the USSR.
- Graham, Frank Jr. "The Breath of Death," *Audubon* July/Aug 1968, and "The Infernal Smog Machine," *Audubon* Sept/Oct 1968. Two splendid articles about air pollution, dealing with industrial and automobile sources, respectively.
- _____ "Ear Pollution," *Audubon* May 1969. About the "new" pollution we are all hearing, but dealing mainly with our second wonder of the modern world, the SST.
- Henkin, Harmon. "Problems in PPM," *Environment* 11-4, May 1969. The subject here is DDT and Coho Salmon in Lake Michigan. The latter were put there to solve an earlier man-made disaster, and appeared to be a rare success in ecological management until our famous and ubiquitous substance appeared.
- Hersh, Seymour M. *Chemical and Biological Warfare*. Bobbs-Merrill, 1968. Anchor 1969 P * See pp. 83-6 and 132-42 on anti-crop and anti-forest defoliation. For other references to the subject of defoliation see: Lappe, M. *subsq. cit.* (Part D.) *Science* Feb 21, 1969; Aug. 1, 1969; Oct. 17, 1969. *Scientific American*, Jan. 1968. *Scientist and Citizen* Aug/Sept. 1967.
- Leopold, A. Starker, et al. "Our Wildlife Refugees—A Hard, Critical Look," *Audubon* May/June 1968. Also in other sources such as *Sierra Club Bulletin* and *National Wildlife*. One of the few "advisory commission" reports worth reading, this is a comprehensive assessment of the current wildlife situation.
- Marine, Gene. *America the Raped*. Simon and Schuster, 1969 * * This is a stimulating book with many annotated references. This reporter is quite good, newly turned on to ecology, and opinionated. Book is a useful if depressing report on the current American environment.
- Marx, Wesley. "How Not to Kill the Ocean," *Audubon* July 1969. An urgent plea for the most important preservation/boondoggle problem of all.
- Mellanby, K. *Pesticides and Pollution*. W. Collins, 1967 * (SB959/M44; B) A survey of British experience and analysis of causes and effects. Very good.
- Mercuric Compounds: *Environment* 11-4, May 1969. This morning's newspaper probably has been fumigated with a mercuric compound. They are so toxic, persistent, cumulative and ubiquitous that Sweden has banned these fungicides entirely. We don't even acknowledge the problem and we use some 200 times as much. The entire issue is devoted to the subject.
- Milne, Lorus and Margery. *The Balance of Nature*. Alfred Knopf, 1960 * Expert writer/scientists, these popular reporters have written a book which has a very good cultural and ethical orientation, and which recounts much of our failure to be "of nature".
- Moore, N. W. "A Synopsis of the Pesticide Problem," *Advances in Ecological Research* 4, 1967. * (QH540/A3; B) This is not only a good synopsis, it is a good exercise in ecology.
- Novic, Sheldon. *The Careless Atom*. Houghton-Mifflin, 1968 * Informative survey of the atomic panacea.
- Rienow, Robert and Leona. *Moment in the Sun: a Dial Report on the Deteriorating Quality of the American Environment*. Dial Press, 1967 P * * Excellent but depressing introduction to the specifics of environmental deterioration.
- Schwartz, William, ed. *Voices for the Wilderness*. Sierra Club-Ballantine, 1969 P. An important collection of well-known essays which not only spell out the case for wilderness preservation, but the implications more often than not involve general environment.
- Stead, Frank M. "California's Cloaca Maxima," *Cry California*, Spring 1969. This is about the third new "wonder of the modern world," The San Joaquin Valley Master Drain. A very clear report on what it is all about. The report is also in *Environment* 11-5, June 1969.
- Stewart, George R. *Not so Rich as You Think*. Houghton-Mifflin, 1968. Excellent writer; covers wide range of pollution, waste and exploitation.
- U. S. Bureau of Mines. *Automobile Disposal: A National Problem*. 1967. (HD9710/U52/A44; ED) There was a time when car corpses were recycled. Then a new steel technology appeared, price relationships changed, and the country is now literally covered with junk autos. That's our free enterprise system at work.
- Watkins, T. H. "Infernal Machines on the Public Lands," *Cry California* Spring 1969. This is about motorcycles, dunebuggies and snowmobiles. The sum is devastation. At a time when some of us are trying to give up internal combustion engines, several million people are finding new ways of playing out their second childhood.
- C. What has Brought the Biosphere to the Point of a Survival Crisis? This is a curious category. There are, it seems to us, many persons advanced in literature for the decline of civilization, the demise of culture or life species. We intend here to do two things. First, we suggest some references for a look at history. Second, and far more important, we wish to provide a single focal point for the subject of population. Overpopulation appears to be a basic and ultimately critical cause of the current state of affairs.
- Bates, Marston. *The Prevalence of People*. Scribner, 1955, 1962 P * * (HB881/B34; M, B) Excellent popular book on the effects of too much mankind.
- Borgstrom, George. *The Hungry Planet*. Collier 1965, P * (HD9000.5/B55; M, SS, PH, Ag) A very serious and absorbing travelogue on world hunger and the earth's biological limits. Explodes several optimistic myths.
- _____ *Too Many: A Study of Earth's Biological Limitations*. Macmillan 1969 * This is a book of realistic calculations. It is one answer to those who are given to technological panaceas.
- Brown, Harrison. *The Challenge of Man's Future*. Compass 1956 P * * This is an early and prescient essay emphasizing overpopulation and recycling.
- Cole, Lamont. "The Ecosphere," *Scientific American*, 198-4, April 1958. Essential reading; a grand overview of the earth's life-support capabilities.
- Commoner, Barry. *Science and Survival*. Viking 1966 P * * (Q125/C62; M, Ag) This book is essential reading for those who want to know what the debate is about concerning uncontrolled environmental experimentation, misuse of science, scientific prostitution, and the amoral, pseudo-objective elements in the world of science.
- Currie, Lauchlin. "Economics and Population," *Population Bulletin* 23-9, April 1967. (HB881/A1/P65; SS, PH) This is a crisis paper, setting forth the dimensions of the crisis effects of exploding population with emphasis on economics and social effects, and attention to both developed and Third World problems.
- Dale, Tom and V. G. Carter. *Topsoil and Civilization*. University of Oklahoma Press * Analyzes world history from the standpoint of man's relation to soil. Very interesting.
- Dansmann, R. F. *The Destruction of California*. Macmillan 1965, Collier 1966 P * The title is self-explanatory, but this book has relevance far beyond state lines. Lots of comparisons with how things used to be.
- Davis, K. "Population Policy: Will Current Programs Succeed?" *Science* 158, Nov. 10, 1967. Strong critique of the inadequacy of family planning for population control; shows why stronger measures are needed. Many good references.
- _____ "Review of Colin Clark: *Population Growth and Land Use*," *Scientific American*, Aug. 1968. Useful essay against the Church and Establishment economics viewpoint.
- Day, Lincoln and Alice Day. *Too Many Americans*. Dell 1964, Delta 1965 P * * (HB915/D3; M, B, UG) Stresses America's responsibility for control of her own population explosion. Note how neglected this point is in much overpopulation literature.
- Egler, Frank. "Pesticides—In our Ecosystem," *American Scientist* 52-1, March 1964. Reprinted in Shepard and McKinley, *Subversive Science*. One of the unusual contributions here is a discussion of the difficulty of transmitting ecosystem knowledge to the public.
- Ehrlich, Paul R. *The Population Bomb*. Sierra Club, Ballantine, 1968 P * The "Rachel Carson" of the late '60's, Ehrlich is another "scare" author who knows what he is talking about. See also Ehrlich, "The Population Explosion: Facts and Fiction," *The Sierra Club Bulletin*, 1968.
- Faulkner, Edward H. *Plowman's Folly*. Univ. of Oklahoma Press, 1943. This book caused a radical re-examination of a widely accepted and ecologically destructive plowing method, one which had been advised by Agricultural Extension people for decades. See also Faulkner, *A Second Look*, where he re-examines the ideas advanced in *Plowman's Folly*.
- Frank, Lewis C. Jr. "People vs. Population," *The Center Magazine* 1-2, Jan. 1968. Deals rather effectively with a variety of population growth myths: cornucopia, self-sufficiency, moderate growth, technological salvation.
- Graham, Frank Jr. *Disaster by Default: Politics and Water Pollution*. M. Evans and Company, 1966 * (TD223/G7; ED) Using many government sources, this book traces a major example of our strange culture/economics syndrome, our tendency to lack foresight, to apply too little too late, and at astronomical cost.
- _____ "The Uncertain Defenders," and "Pesticides, Politics and the Public," *Audubon* May/June and July/Aug. 1967 respectively. A special two part report on control and regulation of pesticide use. Essential reading on pest control policy. See also his forthcoming book *Silent Spring*.
- Hardin, Garrett. "The Tragedy of the Commons," *Science* 162, 1968. The thrust of this article is a lesson in welfare economics—the myopia of individual action and the need for a general policy of "mutual coercion."
- _____, ed. *Population, Evolution and Birth Control*. Freeman 1964, 1969 P. (HD851/H28; SS, B, Ag) Subtitled "A Collage of Controversial Ideas," this is a personal and highly edited collection, but there is much useful and basic material here.
- Jacks, G. V. and R. O. Whyte. *The Rape of the Earth*. Faber, 1939. (S623/J34; UG) Gives a world tour of soil erosion and its history.
- Krutch, Joseph Wood. "The Demise of Natural History," *Audubon* Sept/Oct 1967. Laments the biologist's retreat from nature and cites (from Marston Bates) the Webster's latest definition of natural history as a "former" science.
- Merton, Thomas. "The Wild Places," *The Center Magazine*, 1-5, July 1968. Deals with the "pioneer" love/destruction of wilderness contradiction, and with the (non-unique) contribution of Christianity to environmental destruction.
- Moore, Barrington Jr. *Totalitarianism and Democracy*. This is a fascinating book which discusses the relationship between the form of land ownership and the historical fate of nations like Russia, China, France, England and the U. S. Although the author is not directly interested in ecology, the work does give the reader a picture of the ecological consequences of sharecropping, extended families, exorbitant rents and the like.
- Ordway, Samuel. *Resources and the American Dream*. Ronald Press 1953. (HC103.7/07; M, F, B, UG) A short philosophical essay evaluating the American "religious" drive for an ever higher level of living and our failure to recycle nutrients and other "waste" resources. Condemns growth goals and gadgetry, and argues for limiting consumption and regeneration of an individualism based on productive labor, creativity and careful resource use.
- Osborn, Fairfield, ed. *Our Crowded Planet*. Doubleday, 1962 * (HB851/08; UG, B) The essays discuss various effects of overpopulation including resource depletion, hunger, pollution and crowding.
- Sauer, Carl. "Theme of Plant and Animal Destruction in Economic History," *Journal of Farm Economics* 20, 1938. Reprinted in C. Sauer, *Land and Life*. A classic geography/history/ecology article.
- Spengler, Joseph J., ed. *Population: Theory and Policy*. Free Press 1956 * (HB 881/S67; M, SS, UG) Many articles on population theory, economics, politics and sociology. A basic reference work.
- _____ "Implication of Population Changes for Business," *Commercial and Financial Chronicle*, Aug. 11, 1966. Reprinted by the Population Reference Bureau. This is a speech to industrialists which captures most of the important arguments against population growth for economic growth. Remembering his audience, ignore some of the political overtones expressed.
- Thomas, W. L., ed. *Man's Role in Changing the Face of the Earth*. Univ. of Chicago Press 1956 * (G56/168; M, Ag) This book is expensive and very large but it is a timeless and basic reference on culture/environment history. Widely used by contemporary writers.
- Vogt, William. *People—Challenge to Survival*. Sloane 1960 * (HQ766/V72; UG) Significant is the emphasis given to the USA: its own particular population explosion and its overconsumption of the world's resources.
- White, Lynn. "Historical Roots of our Ecological Crisis," *Horizon* Summer 1967. Reprinted in Shepard and McKinley, *Subversive Science*; in *Sierra Club Annual* 1966-1968; and in *Science* 1967, pp. 1203-7. A classic article, very culture-oriented, stressing the contributions of Christianity and modern technology.
- D. What Can We Do? Give Up and Enjoy Life While It Lasts? There is a great temptation to do the latter, and many people, in a state of extreme pessimism, are inclined to do just that. The most cogent argument against this alternative is that it automatically generates a self-fulfilling prediction: The forces are already at work to such an extent that, if we do nothing, all but the simplest life forms will surely perish.
- The objective in this section is to get us into some possibilities for new life styles, new modes of action and thought, and some old ones which need reviving. As for environmental defense/survival action, one does not read about this in handbooks—one acts!
- Borgese, Elizabeth Mann. *The Ocean Regime. A suggested statute for the peaceful uses of the high seas and the sea-bed beyond the limits of national jurisdiction*. Center for the Study of Democratic Institutions Occasional Paper 1968. See also E. Borgese, "The Republic of the Seas," *Center Magazine* 1-4, May 1968.
- Boulding, Kenneth. "The Economics of the Coming Spaceship Earth," in Jarrett, *Environmental Quality in a Growing Economy*. This essay will probably meet the same fate as many of the author's—neglect. Yet there is some powerful theoretical support here for the minimum consumption thesis.
- _____ "Economics and Ecology," in Darling and Milton, *Future Environment of North America*. An article like this should be the basis for radical revision of the discipline of economics.
- Brooklyn Botanic Garden Record. *Handbook on Biological Control of Plant Pests*. New York, 1960. A pamphlet (\$1.00)—notable evidence that not every Establishment agency is hung up on biocides.
- California Tomorrow. *Cry California* Summer 1969. Entire issue devoted to biocides, including much attention to individual action. A homeowner/gardener's essential handbook. 50¢ per copy from 681 Market, San Francisco, 94105.
- Campbell, Joseph. *Hero of a Thousand Faces*. Campbell probably has a wider range of knowledge of the mythologies and religions of the world than any other individual. This book tells of a theme which Campbell finds in all major and minor religions, the theme of the wanderings and return of the hero. The moral of this ubiquitous story is that man is only one of the phenomena of nature and that he must find his place in the cycle of birth and death. It is this story which has held the ecologically destructive impulses of primitive men in check.
- Carlin, A. "The Grand Canyon Controversy: Lessons for Federal Cost-Benefit Practices," *Land Economics* May 1968. (HD101/J6; SS, Ag, Ed) A review and critique of current resource evaluation procedures. Benefit-cost analysis isn't all that bad—it's just that it's so politically malleable.



Castaneda, Carlos. *The Teachings of Don Juan*. Ballantine, 1969 P. Castaneda tells us his experiences as a pupil of a Yaqui medicine man who is a masterful ecologist—whose knowledge of nature is so balanced by a reverence of nature. Needless to say the medicine man was also well versed in the psychedelic secrets of numerous plants.

Ciriacy-Wantrup, S. V. *Resource Conservation; Economics and Policies*. Univ. California Press 1952, 1963. This is a better economics text than most used in the late undergraduate-early graduate years. Poor references.

Ciracy-Wantrup, S. V., and J. J. Parsons, eds. *Natural Resources, Quality and Quantity*. Univ. California Press, 1967. This is a rather uneven collection of essays, very much lacking cohesion, but there is much interesting material here.

Crocker, T. D. "Some Economics of Air Pollution Control." *Natural Resources Journal* 8-2, April 1968. Excellent, not very technical overview of the economics, including institutional. Stresses the inoperability of receptor property rights.

Dales, J. H. *Pollution, Property and Prices*. Univ. of Toronto 1968. This is an interesting slant on price theory. It proposes no radical changes in our culture, but we would probably have less pollution if we adopted some of the ideas here.

Gaffney, Mason. "Welfare Economics and the Environment," in Jarrett, *Environmental Quality in a Growing Economy*. This is an interesting trip in welfare economics. A refreshing antidote to the tiresome anachronisms in the previous paper by Kneese.

Galbraith, John K. "How Much Should a Country Consume?" in Henry Jarrett, ed., *Perspectives in Conservation*. Resources for the Future, 1958 P. Argues for limiting consumption and criticizes the Twentieth Century Fund for taking various key projections as given. Chides the "sacrosanct" attitude of government toward growth. Especially interesting is the discussion following by Paul Sears.

Gotaas, H. B. *Composting: Sanitary Disposal and Reclamation of Organic Wastes*. World Health Organization Monograph Series 31, 1956. (S661/G68; Ag) This is a basic and semi-technical reference to the recycling of solid wastes.

Hardin, Garrett. "The Economics of Wilderness," *Natural History* June/July 1969. Some interesting proposals for allocating open space, matching degrees of wilderness with degrees of affinity for wilderness.

Haveman, Robert H. *Water Resource Investment and the Public Interest; An Analysis of Federal Expenditures in Ten Southern States*. Vanderbilt Univ. Press, 1965. (HD1695/S6/H2; ED) A strong critique of benefit-cost manipulation.

Howard, Sir Albert. *An Agricultural Testament*. Oxford Univ. Press 1947 * (S661/H6; Ag). A major essay on ecological agricultural economics (i.e. "offbeat"). Howard was a botanist of major standing, the father of modern composting, and a successful large-scale organic farmer.

Howard, Louise E. *Sir Albert Howard in India*. Faber 1953. (S417/H65/H6; M, Ag) Biography of Howard's important recycling experiences.

Jarrett, Henry, ed. *Environmental Quality in a Growing Economy*. Resources for the Future, 1966. This book has several useful essays, some already cited here.

Jouvenal, Bertrand de. "From Political Economy to Political Ecology," *Bulletin of the Atomic Scientists* 8, Oct. 1957. Brief but very culture-oriented essay highlighting some weird thinking we have about economics and environment.

Kneese, Allen V. and B. T. Power. *Managing Water Quality: Economics, Technology and Institutions*. Resources for the Future 1968. (TD423/K55; G, SS) This is an excellent book on the current thinking in Establishment resource management.

Krutilla, John V. "Conservation Reconsidered," *American Economic Review* 57-4, Sept. 1967. Some rather interesting applications of traditional economic principles to the preservation of priceless resources.

Lappe, Marc. *Chemical and Biological Warfare: The Science of Public Death*. Berkeley, 1969. To be published in *Marty Brown, Social Responsibility of a Scientist*, forthcoming. A skillful assessment of the military strategies and intentions in the use of CBW and of the scientist's moral and ethical responsibilities.

Leopold, Aldo. *A Sand County Almanac*. Oxford, 1949 P. Portions on the land-ethic idea are reprinted in Nash, *The American Environment* and Shepard and McKinley *The Subversive Science*. This is classic reading in ecological ethics. A very articulate advocacy of a land ethic.

Lipsett, Charles H. *Industrial Wastes and Salvage*. 2nd edn., Atlas Pub. Co. 1963 (TP995/L55; E, C). It's kind of depressing to know how much recycling we actually do in this country and still we are in this desperate state. An informative book.

McHarg, Ian. "Ecological Determinism," in Darling and Milton, eds., *Future Environments of North America*. McHarg is a trip in himself—an ecological master planner. He doesn't stress population enough, but he is sufficiently outspoken against profit-greed to make up for it.

— *Design with Nature*. Natural History Press, 1969. A McHarg intellectual biography and handbook of ecological possibilities. Poor reference, though, and very expensive. Interesting to note that he thinks a better peace symbol than the dove would be the garden.

Mill, John Stuart. *Principles of Political Economy*. 1848, Univ. Toronto 1967. Mill was one economist who had his head straight about many things, but perhaps that was because he was really a philosopher. See Book 4, Ch. 6 "Of the Stationary State" (which he believes desirable) for some rare and inspiring reading.

Mishan, E. J. "A survey of Welfare Economics 1939-59", *Economic Journal* 70, 1960. If someone wants to know what welfare economics is all about, here it is for the most part. The subject is the theoretical groundwork for resource economics.

— *The Costs of Economic Growth*. New York, 1967. (HC59/M552; SS, M) Mishan is an heretical but very capable economist, and this is an heretical book for the layman, a real stimulant for anti-growth buffs. On pp. 90-93 there is an absolutely funny and right-on parable comparing gunslingers and automobile/freeway freaks. It's all too true.

Moss, Laurence I. "The Great Grand Canyon Subsidy Machine," *Sierra Club Bulletin*, Combined Annual 1966-68. A striking example of (almost) ecological destruction via an all too common of welfare program for the rich. [sic.]

Rodale, J. I., et al. *How to Grow Vegetables and Fruits by the Organic Method*. Rodale Press, 1959. A "required" textbook on agriculture, soil, agronomy and future life-styles.

Rozzak, Theodore. *The Making of a Counter Culture*. Doubleday Anchor 1969 P. A chapter on "The Myth of Objective Consciousness" and an appendix on "Objectivity Unlimited" contribute much to an understanding of our current dilemma.

Sears, Paul B. "The Steady State: Physical Law and Moral Choice," *The Key Reporter* 24-2, Jan 1959. Reprinted in Shepard and McKinley, *The Subversive Science*. A valuable essay on an ethics of life (i.e. a biological ethic).

Tawney, R. H. *The Acquisitive Society*. Harvest 1920 P. A classic—advocates property rights based on function and discharge of social obligations rather than on traditional (cowboy economy) criteria.

Taylor, Paul S. "Excess Land Law: Calculated Circumvention," *California Law Review* 52-5, Dec. 1964. This is what real law n' order is all about, and what California agribusiness is about.

U. S. Congress, Senate, Committee on Public Works. *Waste Management Research and Environmental Quality Management*. Washington 1968 P. This has lots of information and references on the subject. Ask your Congressman for a copy.

U. S. President, Science Advisory Committee, Environmental Pollution Panel. *Restoring the Quality of Our Environment*. Washington 1965 P. Another handbook on technical possibilities, not out of date. Ask your Congressman for this, too.

Van Vuren, J. P. J. *Soil Fertility and Sewage*. Faber 1949. (S567/V3; Ag, PH) * A not too technical description of composting experience in South Africa. The interesting thing about this is that extensive recycling the world over was stimulated by war shortages, including the United States. When the war ended, so did the recycling, except that South Africa found it to be the most economical source of fertilizer. Why? Apartheid labor perhaps?

Wickenden, L. *Gardening with Nature*. Devin-Adair, 1954. The author is a Howard convert, a former skeptic and a renowned chemist who tested all of Howard's ideas out in his lab. A useful handbook.

Wolozin, Harold, ed. *The Economics of Air Pollution; A Symposium*. Norton 1966 P * (HC110/A4/W6; PH) Standard treatment of the subject from the standpoint of received economics.

Wylie, J. C. *Fertility from Town Wastes*. Faber 1955 This is an interesting book with many useful examples of possibilities. Dig the discussion of running agricultural and other machinery on compost gas (methane).

E. Journals (partial list)
Audubon Magazine (QL671/B5; B) 1130 Fifth Ave., N.Y. 10028
Bulletin of the Atomic Scientists (TK9001/B8; M, PH, E) Education Foundation for Nuclear Science, 935 E. 60th St., Chicago, Illinois 60637.
Compost Science. Rodale Press, 33 E. Minor St., Emmaus, Pa. 18049.
Cry California. California Tomorrow, Monadnock Bldg., 681 Market St., S.F. 94105.
Environment. 438 N. Skinner Blvd., St. Louis, Mo. 63130.
IUCN Bulletin. International Union for Conservation of Nature and Natural Resources, 1110 Morges, Geneva, Switzerland.
Journal of Law and Economics. University of Chicago Law School, Chicago, Illinois.
Natural History. The American Museum of Natural History, Central Park West at 79th Street, N. Y., N. Y. 10024.
Natural Resources Journal (HC103.7/N368; F) University of New Mexico Law School, Albuquerque, New Mexico.
Organic Gardening. Rodale Press, 33 E. Minor Street, Emmaus, Pa. 18049.
Population Bulletin (HB881/A1/P65; PH, SS) Population Reference Bureau, 1755 Massachusetts Ave., Washington, D. C. 20036.
Science (Q1/S33; PH, B, Ag, F) American Association for the Advancement of Science, 1515 Massachusetts Ave N.W., Washington, D.C. 20005.
Scientific American (AQ/S32; M) 415 Madison Ave. NY, NY 10017.
Sierra Club Bulletin. Sierra Club, 1050 Mills Tower, San Francisco, Calif. 94104.

SUPPLEMENTARY BIBLIOGRAPHY ON PESTICIDES AND ECOLOGY.
Items marked * are highly recommended and relatively available.

A. GENERAL
* 1. Boulding, K. "The Economics of the Coming Spaceship Earth," in Henry Jarrett, editor, *Environmental Quality in a Growing Economy*, Johns Hopkins, 1966.
* 2. Hardin, G. "The Tragedy of the Commons," *Science* 162, 1968.

B. ON ECOLOGY
* 1. Cole, Lamont. "The Ecosphere", *Scientific American* 198-4, April 1958
2. Elton, Chas. S. *The Ecology of Invasions by Plants and Animals*. Methuen, 1958.
3. Gates, David M. "Toward Understanding Ecosystems," *Advances in Ecological Research* 5, 1968.
4. Goodman, G. T., editor *Ecology and the Industrial Society*. 5th Symposium of the British Ecological Society. Oxford, 1965.
5. Graham, E. H. *Natural Principles of Land Use*. Oxford, 1944.
* 6. Henderson, Lawrence J. *The Fitness of the Environment*. Beacon paper, 1958.
7. Kuenen, D. J. "Man, Food, and Insects as an Ecological Problem," *Proceedings, XVI International Congress of Zoology* 7, 1963.
* 8. Milne, Lorus and Margery. *The Balance of Nature*. Knopf, 1960.
* 9. Odum, E. P. "The Strategy of Ecosystem Development," *Science* 164, April 18, 1969.
10. Pimental, D. "An Ecological Approach to the Insecticide Problem," *Journal of Economic Entomology* 54-1, 1961.

* 11. Sauer, Carl "Theme of Plant and Animal Destruction in Economic History," *Journal of Farm Economics* 20, 1938. Reprinted in C. Sauer, *Land and Life*, Univ. of California Press paperback.

* 12. Woodwell, George M., editor. "Toxic Substances and Ecological Cycles," *Scientific American* 216-3, March 1967.

C. PESTICIDES PROPER
1. Cole Lamont. "Pesticides: A Hazard to Nature's Equilibrium," *American Journal of Public Health* 54-1 (ii) 1964.
2. Conservation Foundation. *Ecology and Chemical Pesticides: Notes and Discussions*. New York, May 1960.
* 3. Egler, Frank E. "Pesticides in our Ecosystem," *American Scientist* 52-1, March 1964. Reprinted in McKinley and Shepard, *Subversive Science*.
4. ——— "Pesticides in Our Ecosystem: Communication II," *BioScience* 14-11, Nov. 1964. Reprinted in Shepard and McKinley.
5. *Journal of Applied Ecology* 3 (Supp.), 1966, "Pesticides in the Environment and their Effects on Wildlife."
6. Kuenen, D. J., editor. *The Ecological Effects of Biological and Chemical Control of Undesirable Plants and Animals*. 8th Technical Meeting of the International Union for Conservation of Nature and Natural Resources. 1961.
7. Mellanby, K. *Pesticides and Pollution*. W. Collins, 1967.
8. Moore, N. W. "A Synopsis of the Pesticide Problem," *Advances in Ecological Research* 4, 1967.
* 9. Rudd, Robert L. *Pesticides and the Living Landscape*. Univ. Wisconsin Press paperback, 1964. Highest recommendation. This is what it's all about.

D. NATURAL CONTROL OF PESTS
1. Brooklyn Botanic Garden Record. *Handbook on Biological Control of Plant Pests*. New York, 1960.
2. DeBach, Paul H., editor. *Biological Control of Insect Pests and Weeds*. Reinhold, 1964.
3. Hills, Lawrence D. *Pest Control without Poisons*, Henry Doubleday Research Association, 1964.
6. [sic] Solomon, M.E. "Analysis of Processes Involved in the Natural Control of Insects," *Advances in Ecological Research* 2, 1964.
7. Stern, V. M. et al. "The Integrated Control Concept." *Hilgardia* 29-2, 1959.
8. Thompson, W. R. "Biological Control and the Theories of Interactions of Population," *Parasitology* 31, 1939.
9. ——— "The Fundamental Theory of Natural and Biological Control," *Annual Review of Entomology* 1, 1956.
10. Watt, K.E.F. "Community Stability and the Strategy of Biological Control," *Canadian Entomologist* 97, 1965.

E. SOME BASIC LIFE SUPPORT KNOWLEDGE (ABOUT SOIL AND LAND) AND A SUGGESTION FOR INDIVIDUAL ACTION (ORGANIC GARDENING)
1. Cocannouer, Joseph A. *Farming with Nature*. Univ. Oklahoma Press, 1954.
2. Howard, Sir Albert. *The Soil and Health*. Devin-Adair Co.
3. Rodale, J. I. et al, *How to Grow Vegetables and Fruits by the Organic Method*. Rodale Press.
4. ——— *The Organic Way to Plant Protection*. Rodale Press, 1966.
5. Wickenden, Leonard. *Make Friends with Your Land*. Devin-Adair Co. 1949.

ADDENDA TO "D"
4. Milne, A. "The Natural Control of Insect Populations," *Canadian Entomologist* 89, 1957.
5. Rodale, J. I. *Control Garden Pests without Poison Sprays*. Rodale Press 1962.

COMMENTS.
1. This is obviously an incomplete list. The important thing is to get into the subject. Check the references in your first couple of readings and you'll soon find your own trip.
2. The *Scientific American* articles noted are available in their reprint series. Inquire at your favorite bookstore.
3. All of these references are available in the library system on the U.C. Berkeley campus.
4. In section "B" the Graham, Henderson and Sauer books are classics.
5. In section "C" the Mellanby and Rudd books are essential books for lay readers. Rudd's book covers mainly American research and it is oriented toward the effects on wildlife, but it is really a very lucid, basic text on pesticides.
6. About the organic gardening trip—You don't have to be a green thumb to get into this. The main thing is to understand something about the subject because it is the best way to break our cultural hangup about bugs, snakes, germs, worms and beasties, and knowledge in the area is a great foil against agribusiness propaganda. For example, it is simply not true that organic farming is not feasible on a reasonably large scale. The proof is available to anyone who is willing to open his mind. The references also give us the most fascinating insight into plant/soil/organism systems.

Prepared by David Hupp for Ecology Action
ECOLOGY ACTION Educational Institute, Box 9334, Berkeley, CA 94709
Office: 1701 Carleton St., Berkeley 843-1820, 849-3388
Recycle this paper





Death, Old Friend

This is not yet a section proper, but an invitation to a section. The whole system of human life has been appreciated only in its ascendant aspects lately. We have entire industries—medicine, warfare—devoted to death-prevention, and a kind of pathological secrecy has surrounded the event of dying.

Dick Alpert, several years ago, proposed a Center for Birth and Dying. A place where, if you were going to die or wanted to die, you go and do it in style, perhaps even grace. There would be whatever religious, pharmaceutical, medical aid you wanted. (If LSD has been proven to ease the departure of terminal cancer patients, why is it not in general use? What else enhances the experience of death?) The Center is also a place for natural childbirth, family supported, so that arrival and departure in this world are not estranged.

Now that we are getting more and more home-made births going on, I wonder if home-made dying and burial is growing as well. We invite photographs and accounts of down-home birth and death for publication. Since there's legal weirdness around these subjects, we will not publish or reveal names, sources, locations unless requested to. We will publish whatever increases familiarity with these events closest to the heart of human life.

To Gary Snyder

I'm looking to do a page eventually of photographs of homemade births and homemade burial (and homemade dying). Know of any? The legal and media restrictions around mortality are truly mad . . .

From Gary Snyder

Home made birth is important: we need the laws changed back to allow (licensed if need be) midwives to function. And do-it-yourself also. As for death, that *IS* maddening. Shd be no coffins, etc.—simple earth burial & plant a tree. I don't have any photographs.

To Lenny Bruce

About ten years ago when I was into psychology stuff, I bumped into a guy I knew from high school days. He was an undertaker in Boston and he asked me if I knew anything about suicide.

"Well like what?" I said, in that clinical noncommittal voice I had mastered.

"Cause everytime we get a suicide, it's the weirdest thing but they always got this grin on their faces. No matter how they go: hanging, gas or whatever, they always got this certain grin"

"You sure that's true?"

"No shit, we even got a name for it in the trade it's called 'THE SHIT-EATIN GRIN' and every one of the fuckers got it...."

"What do you do about it? Like how come nobody but undertakers knows about it?"

"Are you kiddin? We couldn't talk about a thing like that, not in our position. We even have to change the expressions on their face. You know, make em look more serious. They fight like hell even if they're dead. We have to use special needles to relax their face muscles and finally we get em lookin serious enough for the funeral. I mean you just could never bury a guy with a shit-eatin grin, no sir."

This story is for you, Lenny, from all the Yippies

"Dedication to Lenny Bruce"
from Abbie Hoffman's *Woodstock Nation*.
\$2.95 from Random House, Inc., 201 E. 50th
Street, New York, N. Y. 10022. Reprinted
without permission.

BEQUEATHAL OF BODIES OF YOUNG PEOPLE FOR RADIATION RESEARCH

There is important need for bodies of disease-free young adults (who have been killed in accidents) to permit the study of radiation normally present at various ages.

Recent reports of the International Commission of Radiological Protection indicate urgent need for broader research on internal radiation by age groups. The Atomic Energy Commission is prepared to make such studies in collaboration with various medical schools throughout the country. Little has been done thus far due to lack of suitable bodies.

Students and other idealistic young people are encouraged to get their parents or spouses to sign a legal release that will permit them to bequeath their bodies (in case of accidental death) to radiation research. It is essential that suitable papers be carried, explaining the bequeathal, forbidding the embalming of the body and giving instructions for its transportation.

Bodies are subsequently returned for burial if desired, or are cremated and the ashes disposed of as specified by the family.

An inquiry directed to the Falconer Foundation, 66 West 87th Street, New York 10024 (212-877-7586), will bring the necessary information and papers.

From *A Manual of Simple Burial*, Ernest Morgan, \$1 from The Celso Press, Arthur Morgan School, Box 79, Route 5, Burnsville, North Carolina 28714

Also available from Celso Press (above) "Certificate for Bequeathing Body" (if you want your body to be used for medical purposes) 4 for 25¢; and "Putting Your House in Order" (a form for all the information that survivors need—how not to be a dead nuisance) 40¢ per copy, 3 for \$1.

The death of Osceola, the Seminole January 30, 1838

About half an hour before he died, he seemed to be sensible that he was dying; and although he could not speak, he signified by signs that he wished me to send for the chiefs and for the officers of the post, whom I called in. He made signs to his wives (of whom he had two, and also two fine little children by his side), to go and bring his full dress, which he wore in time of war; which having been brought in, he rose up in his bed, which was on the floor, and put on his shirt, his leggings and moccasins—girded on his war-belt, his bullet-pouch, and powder-horn, and laid his knife by the side of him on the floor. He then called for his red paint, and his looking-glass, which was held before him, when he deliberately painted on half of his face, his neck and his throat—his wrists—the backs of his hands, and the handle of his knife, red with vermilion; a custom practised when the irrevocable oath of war and destruction is taken. His knife he then placed in its sheath, under his belt; and he carefully arranged his turban on his head, and his three ostrich plumes that he was in the habit of wearing in it. Being thus prepared in full dress, he lay down a few minutes to recover strength sufficient, when he rose up as before, and with most benignant and pleasing smiles, extended his hand to me and to all of the officers and chiefs that were around him; and shook hands with us all in dead silence; and also with his wives and his little children; he made a signal for them to lower him down upon his bed, which was done, and he then slowly drew from his war-belt, his scalping-knife, which he firmly grasped in his right hand, laying it across the other, on his breast, and in a moment smiled away his last breath, without a struggle or a groan.

Catlin, *The North American Indians*,
Vo. II, p. 251n.

The Indian in America's Past,
Jack D. Forbes, \$1.95 from Prentice-
Hall, Englewood Cliffs, N.J. 07632

FOR PHOTOS, A POLAROID BIG SWINGER IS
THE CHEAPEST AND HANDIEST.

Process

HOME METHANE GENERATOR

We've been sniffing around for months for hard information on the rumoredly easy production of burnable methane gas from anaerobic fermentation of human and animal waste. John Steinbeck Jr referred to it in a column about Korea. Last September Len Brackett in Oregon wrote us a letter asking about it. We published the question and got the following information.

RE: Len Brackett's question on the methane generator.

I worked in a cow-dung gas plant research station in India, where we ran Coleman-type lanterns, a gas stove, and a ten-horse-power shop engine from the methane produced from 14 buffalo. For specific information & pamphlets write:

Ram Box Singh
Gobar Gas Research Station
Ajitmal
Etawah, U.P., India

Larry Dobson
San Francisco

With reference to your letter dated Oct. 16, 1969 I am sending one brochure on obtaining methane from Cow-dung and other organic farm wastes. In India we are installing various types of gas plants and of different sizes depending on the availability of organic wastes. We often publish our data of Research in Hindi.

Two drawings of 100 and 1500 cft. per day gas production plants are also being sent for your use. These units can easily be installed and operated in southern states of U.S. where climate is somewhat temperate.

R. B. Singh
Etawah, U.P., India

The Gobar Gas pamphlet has good information and table on the output and uses of methane generators.

re: inquiry by Len Brackett about methane generator

My granddaddy tried this back in Latvia before his farm became a commune. The whole thing consists of 3 or 4 large airtight composting tanks connected to a storage tank thusly:

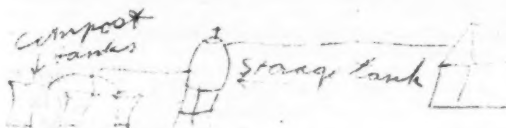

Anaerobic decomposition creates methane which can be collected for use (in areas where there is no freezing). Needless to say, grandpappy decided that it wasn't worthwhile in Latvia, and demolished it in favor of a giant compost heap with clay pipes running under & through it. Since the compost heap heats up to 160-180° F. while active, and he had lots of animals, he provided a good portion of his winter heat this way, & used kerosene for light.



If Len wants to try building a methane generator please forward this—

1) Use large clay culverts & poured concrete for storage tanks. Just pour concrete bottom into tank & fashion a rubber lined lip for tap. Cover this with another heavy concrete slab. The tanks should hold at least 3 cu. yards of fresh manure each.

2) Connect these to a similar tank for storage, & pipe to use area.

3) The efficiency depends primarily on how airtight you can get the system. In low freeze areas you could probably get enough cooking gas out of it, but not heat, as the process is fairly slow. (Manure is exhausted in 4-6 weeks)

Peace, love, internal freedom—
M. Ozols
N. Y., N. Y.

By far the most complete information we've found on building a methane generator is in the book *Composting* (from WHO), which devotes a whole chapter to the subject.

FIG. 41. SKETCH OF MANURE GAS PLANT WITH LATRINES

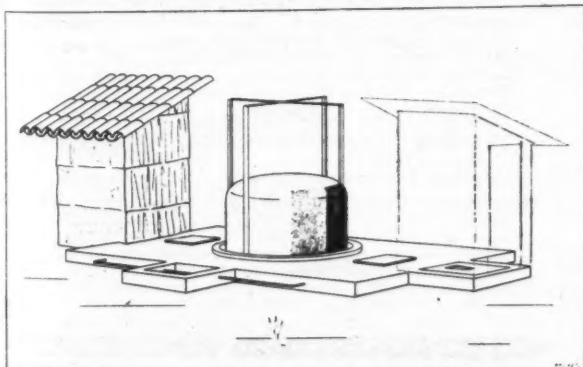

Bum trip conversion—a query

Abbie Hoffman says we are learning and teaching each other all the necessary survival skills, like how to get off a bumper. Send your favorite remedies and we'll publish what we can. How do you recognize your bumpers? What works for you to neutralize them or convert them into solar energy? How do you make use of the bumpers you can't convert? Good information in these matters might apply to the great current planetary bumper we're swimming in.

From Manny Meyer

I.E. methane gas: During the 1940s or thereabouts when gasoline was scarce in Europe, farmers converted their vehicles to run on methane gas. This was done using the same engine block and pistons. Power output was very low but the cars and trucks kept running. Trailers were attached to cars (sealed) and they were filled with shit from cows and humans (us). The gas(methane) that emerged ran the vehicle. (Has anyone thought of bottling farts yet?)

If you like boots that are insulated and that cover your ankles and that are waterproof but don't like to carry lead weights on your feet, try Sears kangaroo leather boots. They cost about \$32 but are well worth it. They weigh about as much as wallabies because kangaroo leather is incredibly light. The only thing is that they don't sell them in the shoe dept. but in the sporting goods dept. (ask Norm Linke about them). They are dark green in color just like kangaroos.

For Dome builders: If you have trouble finding formulas to tell you how big you want your dome to be, panelsize etc. try HMS Coxeters "regular polytopes" best book for this stuff.

I found Geo-stixs great but you can get them direct from the factory box 306 Spokane, Wash. 99206

Bad books to buy not: Glenns Foreign auto repair manuals. Those yellow hard cover books that cost so much. If you followed the instructions in them then your car will stop running. . . . now. They take general formulas and apply them to cars that won't plug in. For example, in the manual on Peugeot 403 they tell you to tighten down the head bolts while the engine is hot. This may work for cars with cast iron heads but unfortunately most foreign cars including peugeots have aluminum heads. The best way to describe what would happen if you did this would be the sound similar to the rice crispies ad.

Used distributor caps make great rapido-graph pen holders.
love manny
Bellevue, Wash.

Polar Operations

Recently we received a Navy publication for review which may be of interest to aqua-libertarians: POLAR OPERATIONS, by Captain Edwin A. McDonald (Retired), \$11.50 from your book store or from The United States Naval Institute, Annapolis, Maryland 21402.

Here, accessible (?) from all oceans, is a continent containing one-tenth of the world's land area and a small scattering of international inhabitants in about 30 bases owned by 11 countries, having a status much like the moon's or the ocean's, meaning that the camp belongs to whoever's flag is flown. Why couldn't some non-national colony or cult of skiers or snowmobilers set up camp under a new flag in a vacant snow drift?

EDUCATION

Sources of Information about Education

compiled by John Holt

Anarchy Magazine	Freedom Press, 84A White Chapel High Street, London, England
Libertarian Teacher	36 Devonshire Rd., Mill Hill, London NW7, England
Manas	P. O. Box 32112, El Sereno Station, Los Angeles, Calif.
New Republic	1244 19th St. NW, Washington DC 20036
New York Review of Books	250 W. 57th Street, NYC, 10019
Village Voice	Nat Hentoff column. Sheridan Sq NYC
Saturday Review	380 Madison Ave., NYC 10017 (education issue monthly)
This Magazine	P.O. Box 876, Terminal A, Toronto, Canada
Colloquy	United Church Press, 391 Steel Way Lancaster, Pa.
About Education	8th Floor, 219 Broad Street, Philadelphia, Pa.
Idea Exchange	Education Associates, Inc., Upward Bound, 171 Mass. Ave., Washington DC
Grade Teacher	23 Leroy Ave., Darien, Conn. 06820
New England Free Press	691 Tremont Street, Boston, Mass 02118
Humanitas	Box 606, Orange City, Fla. 32763
Project Follow Through	E.D.C., 55 A Chapel Street Newton, Mass.
Radicals in the Professions	Newsletter of Radical Education Project, Box 625, Ann Arbor, Mich. 48106
Summerhill Society	6063 Hargis St, Los Angeles, CA 90035
Summerhill Society Teachers and Writers Collaborative	5 Beekman Street, NYC
Schools for the Future	125 Washington Place, NYC
New Schools Exchange	Specialized seminars. 821 Broadway, NYC
Herbert Kohl	2840 Hidden Valley Lane, Santa Barbara, CA 93103
Gerald Friedman	Special Consultant to Berkeley Public Schools, 178 Tamalpais, Berkeley, CA
Charles Rathbone	Director, Bay Area Conference on Non-Authoritarian Teaching, 2446 McKinley, Berkeley, CA 94703
Change	Has a bibliography of British Primary Education readings. Oberlin College, Oberlin, Ohio
	59 E. 54th Street, New York City 10022

FIG. 43. CROSS-SECTION OF DIGESTER AND LATRINE

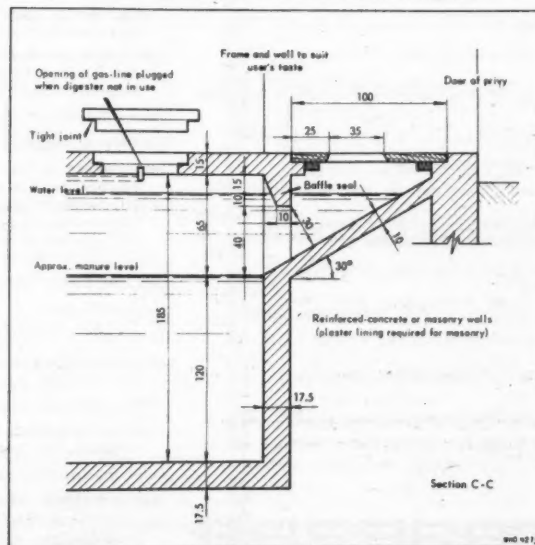

All measurements are in centimetres.

Composting
Harold B. Gotas
World Health Organization
1956; 205 pp.

\$5.00 postpaid

from:
Columbia University Press
136 South Broadway
Irvington-on-Hudson, N.Y. 10533

or WHOLE EARTH CATALOG

WHOLE CONSCIOUSNESS CATALOG
Baba Ram Dass' booklist

Rough Draft

"Painted cakes do not satisfy hunger."

Where books may not be available at local bookstores, the following are book specialists of the oriental and occult, etc.:

SAMUEL WEISER, 734 Broadway, NYC 10003 (GR 7-8453)
 ORIENTALIA, INC., 11 E. 12th St., NYC (AL5-9230)
 MASON'S BOOKSHOP, 789 Lexington Ave., NYC (832-8958)
 ARUNCHALA ASHRAMA, 342 E. 6th St., NYC (477-4060)
 SUFISM REORIENTED, 1290 Sutter St., San Francisco, Calif.
 VEDANTA PRESS, 1946 Vedanta Place, Hollywood, Calif.

INTRODUCTORY READING

Bhagavad Gita, Translations of:
 Arnold, Sir Edwin. *THE SONG CELESTIAL*. Dial, \$7.50
 Mascaro, Juan. Penguin Classic, pap. .95; Vedanta Press, \$2.50
 Prabhavananda & Isherwood. Mentor pap. .75

The Holy Bible, King James Version

Bucke, Richard M. *Cosmic Consciousness*. Univ. Bks. 1961 \$5.95
 & pap. Ed. by Acklom, George M. Rev. Ed. Dutton \$7.50

Buddha, The Life and Sayings of. (Find one that suits your level.)
 Sayings of Buddha, Tr. by J. H. Moore. AMS Press. \$8.50
 Some Sayings of Buddha: According to the Pali Canon, Tr. by
 F. L. Woodward. Oxford Press. \$2.75
 Words of Wisdom, Ed. by G. F. Allen: Hillary, 1959. \$2.25

Castaneda, Carlos, *The Teachings of Don Juan: A Yaqui Way of
 Knowledge*. Ballantine Books, N. Y. Pap.

Collin, Rodney. *Theory of Celestial Influence*. Vincent Stuart:
 London

Daumal, Rene. *Mount Analogue*. Pantheon: New York, 1962.
 \$3.00 & Pap. (The ascent of the soul symbolized by a
 mountain-climbing expedition.)

de Chardin, Pierre Teilhard. (Choose from many.) [See Advanced
 Christian Mysticism]
The Phenomenon of Man. NY: Harper Torchbooks, \$1.75

French, Reginald M. *Way of the Pilgrim, The*. Seabury Press,
 NY \$1.95 pap.

Govinda, Lama Govinda. *Foundations of Tibetan Mysticism*.
 Rider & Co. \$3.75

Gurdjieff, George. *Meetings with Remarkable Men*. Dutton,
 NY, 1963. \$5.95 & pap. [See Advanced Gurdjieff]

Heinlein, Robert A. *Stranger in a Strange Land*. Putnam, NY,
 1961, \$4.95. Avon pap. .75 (A utopia of interpersonal society)

Hesse, Hermann. *Journey to the East*. NY: Noonday, \$1.25 pap
Siddhartha. NY: New Directions, \$1.25

Huxley, Aldous. *The Perennial Philosophy*. (An attempt to present
 the highest common factor of all mystical experience by assembling
 passages from the writings of saints and prophets, eastern and
 western, who have approached a direct spiritual knowledge of
 the Divine.) NY: London: Harper Bros. 1945 pap. Meridian-
 World Pub.

Isherwood, Christopher. *Ramakrishna and his Disciples*. Simon &
 Schuster [See Advanced Ramakrishna]

I Ching—Book of Changes. Trans. Richard Wilhelm. NY: Pantheon
 \$7.50 Princeton Univ. Press, Wilhelm Bollingen Series;
 Dutton pap. trans. John Blofeld \$1.45

James, William. *Varieties of Religious Experience*. Mentor Book
 pap. .95

Kapleau, Philip. *The Three Pillars of Zen*. Harper & Row, N.Y.
 Also pap. Beacon Press, \$2.45 [See Advanced Zen]

Krishnamurti. *Education and the Significance of Life*. Harper & Row

Laski, Margharita. *Ecstasy*. (A study of religious and secular
 experiences.) London: Cresset Press, 1961

Marsh, John. *Saint John*. Pap. Pelican-Penguin books \$2.65

Meher Baba (Books on the work and life of Meher Baba include:
God Speaks! The Theme of Creation and Its Purpose. Dodd,
 Mead & Co.

Listen, Humanity, narrated & edited by D. E. Stevens. Dodd,
 Mead & Co. 1957

Discourses. Vols. 1-5. Adi K. Arana, Meher Pub. King's Rd.,
 Ahmednagar-Deccan, Bombay State, India, 1954
 [See Advanced Sufi]

Neel, Alexandra David. *Secret Oral Teachings in Tibetan Buddhist
 Sects*. Maha Bodhi Society of India, Calcutta.
 [See Advanced Buddhism]

Niehardt, J. G. *Black Elk Speaks*. (The life story of a holy man of
 the Ogalala Sioux) NY: W. Morrow & Co., 1932 pap. Univ. of
 Nebraska 1961

Ouspensky, P. D. *In Search of the Miraculous: Fragments of an
 Unknown teaching*. NY: Harcourt Brace 1949 \$8. Also pap.
 Bantam NY 1968 .95
 [See Advanced Gurdjieff]

Prabhavananda, Swami & Isherwood, C. trans. *How to Know God*.
 [See Advanced Hindu]

Ramana Maharshi, *Sayings of*. (Center located at Arunachala Ashrama)
 [See Advanced Hindu]

Ramayana, *The*. (Tulsidas; if available) or R. C. Dutt, Everyman

Ram Tirtha, *In the Woods of God Realization*

Shah, Idries. *The Way of the Sufi*. Johnathan Cape \$4.50 cloth

The Srimad Bhagavatam: The Wisdom of God. pap. Capricorn, Putnam

Steiger, Brad. *In My Soul I am Free*. Lancer pap. .75

St. John of the Cross. *Dark Night of the Soul*. Doubleday .75
 [See Advanced Christian]

Tagore, Rabindranath. *The Religion of Man*. Beacon pap. \$1.95

Underhill, Evelyn. *The Essentials of Mysticism*. Dutton & Co. pap
 \$1.35

The Cloud of Unknowing. John M. Watkins, London.
 Available in pap.

Upanishads, The. Mascara trans. in Penguin Classic pap 1965 .95

Vivekananda, Swami: *Raja Yoga*. Ramakrishna Vivekananda
 Center NYC
 [See Advanced Hindu]



Walker, Kenneth. *The Conscious Mind*. Wehman, 1962. \$4.95
 Warren, H. C. *Buddhism*. Atheneum Press, 1963. pap. \$1.95
 Waters, Frank. *Book of the Hopi*. Viking Press, NY 1963
 Yogananda, Paramahansa. *Autobiography of a Yogi*. Self Realization
 Fellowship. 8th Edition 1959. \$4 (To get a great feeling for what
 it's really like in India. He tells it just like it is.)
Sayings of Yogananda. Self Realization Fellowship
Metaphysical Meditations.

INTRODUCTORY METHODOLOGY

Bernard, Theos. *Hatha Yoga*. London: Rider
Land of a Thousand Buddhas. London: Rider

Byles, Marie. *Journey into Burmese Silence*. George Allen & Unwin.
 London. (Day by day adventures at various Burmese Buddhist
 meditation centers.)

I Ching—Book of Changes. Trans by Richard Wilhelm. NY Pantheon \$7.50
 trans. John Blofeld, Dutton pap. \$1.45

Kapleau, Philip. *The Three Pillars of Zen*. Harper & Row NY pap.
 Beacon Press \$2.45

Lao Tzu. *Tao Te Ching*. Various editions. Blankney trans. Mentor
 pap. .75

Prabhavananda, Swami & Isherwood, C. *How to Know God: The
 Yoga Aphorisms of Patanjali*. Vedanta Press \$2.50

Rele, V. G. *Yoga Asanas for Health and Vigor*.

Reps, Paul. *Zen Flesh, Zen Bones*. Rutland, Vt. Charles E. Tuttle Co.
 Doubleday, Anchor pap. .95 (A collection of Zen writings, including
 101 Zen stories, the Gateless Gate, and centering exercises.)

Sobhana, Dhammasudhi. *Insight Meditation*. Vipassana Method.
 Published by the Committee for the Advancement of Buddhism.
 E. Sheen, London.

Vishnudevananda, Swami. *The Complete Illustrated Book of Yoga*.
 NY: Bell Publishing Co.

Vivekananda, Swami. *Raja Yoga*. Ramakrishna-Vivekananda Center,
 NYC. Deluxe Pocket Ed. \$2.50
Jnana-Yoga. \$2.50

Yesudian & Haich. *Yoga and Health*. Harper & Row

INTRODUCTORY MEDITATION

Alexander, F. A. *In the Hours of Meditation*. Advartta Ashrama,
 4 Wellington Lane, Calcutta, India

Ashavakra Gita. Shatri, Cloth \$1.50
Holy Bible. King James Version [See Intro. Reading]
Bhagavad Gita [See Intro. Reading]

Shankara's Crest—Jewel of Discrimination. Vedanta Press.
 Hollywood

The Srimad Bhagaratam—The Wisdom of God. Pap. Capricorn Putnam
Upanishads, The. [See Intro. Reading]

ADVANCED BUDDHIST

Babbitt, Irving, Trans. *The Dhammapadam*. (Trans from Pali with an
 essay on Buddha and the Occident) New Directions Paperback

Blofeld, John, Trans. *The Zen Teachings of Huang Po*. pap. \$1.45

Byles, Marie. *Journey into Burmese Silence*. Allen & Unwin
Pathways to Inner Calm. Allen & Unwin

Chang, Garma, Trans. *The Hundred Thousand Songs of Milarepa*.
 Part I and Part II. University Books

Conze, Edward. *Selected Sayings from the Perfection of Wisdom*.
 The Buddhist Society, 58 Eccleston Square, London, SW 1
Buddhist Meditation. Harper Torch pap. \$1.60

Coomeraswamy. *Buddha and the Gospel of Buddhism*. pap. \$2.95

David-Neel, Alexandra. *Initiations and Initiates in Tibet*.

Evans-Wentz, W. Y. Ed. (Many books available in pap.)
The Jewel of Liberation (out of print at present)
Tibet's Great Yogi, Milarepa. (BIOG.) Oxford University Press \$2.25
Tibetan Yoga & Secret Doctrine. NY: Oxford, 1955
The Tibetan Book of the Dead. NY: Oxford, 1957 \$4.50
The Tibetan Book of the Great Liberation. NY: Oxford, 1955

Govinda, Lama. *The Way of the White Cloud*. London, Hutchinson

Herrigel, Eugene. *Zen in the Art of Archery*. pap. McGraw Hill \$1.95

Hoffman. *The Religions of Tibet*. Macmillan 1969

Humphreys, Christmas. *The Wisdom of Buddhism*. Random House
The Buddhist Way of Life. Allen & Unwin

Merton, Thomas. *Mystics and Zen Masters*. pap. \$1.95

Price, A. F. (Trans.) *The Diamond Sutra of the Jewel of Transcendental
 Wisdom*. The Buddhist Society, 16 Gordon Sq., London WQ 1 1947

Pali Canon—Jataka Stories, Vols. I, II, III. Pali Text Society
 Rahula Walpola. *What the Buddha Taught*. Gordon Fraser
 Shattock, E. H. Rear Admiral. *An Experiment in Mindfulness*.
 Dutton & Co. Satipatthana Method.

Sobhana Dhammasudhi. *Insight Meditation*. Buddhapadipa Temple,
 East Sheen, London.

Suzuki, D. T. *Zen Doctrine of No Mind*. pap. \$2.50 Rider & Co.
The Training of the Zen Buddhist Mind. University Books

Trungpa Chogyam. *Born in Tibet*. Harcourt Brace & World
Meditation in Action. Stuart Watkins, London

ADVANCED CHRISTIAN MYSTICISM

The lives of the Christian saints are very inspirational. Choose from
 many.

A Kempis, Thomas. *The Imitation of Christ*. Image Books. pap. .65

Beevers, John. *Storm of Glory—The Story of St. Theresa of Lisieux*.
 Image Books pap. .75

Blakney, Raymond B. *Meister Eckhard, 14th Century Mystic and
 Scholar*. pap. \$2.95 Harper Torchbook

Brother Lawrence. *The Practice of the Presence of God*. trans. from
 French. Revell Inspirational Classics \$1.00

de Chardin, Pierre Teilhard. *The Future of Man*. NY: Harper
 1965 \$3.00
Hymn of the Universe. NY: Harper, 1965 \$3.00
The Divine Milieu. NY: Harper, 1960. London: Collins' Fontana
 Bks.

Doresse. *Secret Books of the Egyptian Gnostics, The*. Viking Press
 (Gospel of Saint Thomas included—very important)

Law, William. *A Serious Call to a Devout & Holy Life*. Fontana Lib.
 \$1.25

Maynard, Theodore. *Saints for Our Times*. Stories of 18 saints. Image
 Books, pap. .85

Merton, Thomas. *The Sign of Jonas*. Day by day account of life in a
 Trappist monastery. Image Books pap. .95
The Seven Storey Mountain. Autobiography
Silence in Heaven: A Book of the Monastic Life.

Owens, Clifford P. *A Story of Jesus*. ARE of NY. 34 W. 35th St., NYC
Philokalia. Work of Early Church Fathers.

St. Frances de Sales. *Introduction to the Devout Life*. Ed. by John K.
 Ryan. -Image pap. .85

St. John of the Cross. *Dark Night of the Soul*. Doubleday pap. .75

Waddell, Helen, *The Desert Fathers*. Constable Co. 1946

Workman, Herbert B. *Evolution of the Monastic Ideal*. Beacon pap.
 \$2.25

EGYPTIAN

de Lubica, Isha Shwaller. *Her-Bak—Chick-Pea, Egyptian Initiate*,
 Vols I & II. Hodder & Stoughten Ltd., 1967 \$7.50

ADVANCED GURDJIEFF

All and Everything. Ten books in three series, of which this is the
 first series: *Beelzebub's Tales to his Grandson*. NY: Dutton,
 also available from Univ. Bks.

Lefort, Rafael. *The Teachers of Gurdjieff*. Victor Gallancz London
 Ltd. 1966

Nicoll, Maurice. *Living Time—And the Integration of Life*.
 Vincent Stuart, London \$5.00
The New Man. An interpretation of some parables and miracles
 of Christ. London: Stuart & Richards, 1950

HASSIDISM

Buber, Martin. *Hassidism and Modern Man*. Tr. Maurice Friedman.
 Harper & Row pap. T8839 \$1.75
I and Thou. 2nd ed. trans. by Ronald Gregor Smith, The Scribner
 Library pap.

Runes, D. Dagobert. *The Wisdom of the Kabbalah*. pap. \$1.50

ADVANCED HINDU

Aurobindo, Sri. *The Adventure of Consciousness*. Sri Aurobindo
 Ashram, Pondicherry
Thoughts and Aphorisms.

Avalon, Arthur. (pseud. for Sir John Woodroffe)
Serpent Power. Vedanta Press (Ganesh)
Introduction to Tantra Sastra
Shakti Power

Ayyangar. *Yoga Upanishads*. Adyar Library, English \$6.00

Bailey, Alice. *Patanjali*. (A paraphrase of Yoga Sutras. Lucis
 Pub. 1950
Light of the Soul

Bucke, R. M. *Memorial Society Newsletter-Review*. An outstanding
 spiritual newsletter. \$1.00 a copy. Send to R. M. Bucke
 Memorial Society, 1266 Pine Avenue West, Montreal, Quebec,
 Canada

Danielous, Alain. *Yoga: The Method of Re-Integration*.
 Christopher Johnson, London

Mishra, Rammurti, Dr. *Fundamentals of Yoga*. Lancer Books,
 NY pap. \$1.25

Narayananda, Swami. *The Secrets of Prana, Pranayam and Yoga
 Asanas*.

Nikhilananda, Swami. *The Upanishads*. pap. Harper Torchbooks \$2.45

Patanjali, Yoga Sutras of. Inter. Charles Johnson. London: Stuart
 & Watkin.

Yoga System of Patanjali. J. H. Woods Harvard Oriental Series.
 (To go into Raja Yoga more deeply.)

Radhakrishnan, S. *The Principal Upanishads*. Trans. George
 Allen & Urwin. Pap. & hardcover.

Ramdas, Swami.
In the Vision of God Thus Speaks Ramdas
Gita Sandesh Ramdas' Talks
Letters to Ramdas World is God
Ramdas Speaks (10 vol) Sayings of Ramdas
The Pathless Path Divine Life
Call of the Devotee

(By other writers about Ramdas: *Passage to Divinity—A
 Devotees Diary*.
 Order from Anandashrama Kanhangad Rly. Stan. Kerala, So. India

Ramakrishna. *The Gospel of Ramakrishna*. Ramakrishna Vivekananda
 Center
The Life of Ramakrishna. Romain Rolland, Advaita Ashram
Ramakrishna and the Vitality of Hinduism. Solange Lamaitre.
 Funk & Wagnalls, 1969

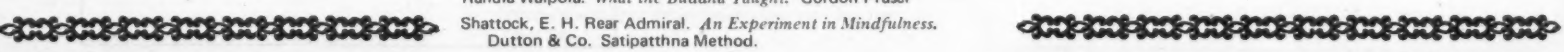

LITERARY AND SCIENTIFIC MYSTICISM

Ramana Maharshi. *Talks with Sri Ramana Maharshi*. Day by Day with Bhagavan Guru Ramana (S. S. Cohen) Maharshi's Gospel Ramana Maharshi and His Philosophy of Existence Reflections on "Talks" Sadhu's Reminiscences of Ramana Maharshi (Major A.W. Chadwick) Self-Inquiry Who Am I? Order from Arunachala Ashram, 342 E. 6th Street., NYC. Also available— "The Mountain Path," an excellent magazine for spiritual seekers.

Singh, Kirpal. *A Great Saint—Baba Jaimal Singh*. His Life and Teachings. *The Japji*. The Mystery of Death. Ruhani Satsang, Sawan Ashram, Shakti Nagar, Delhi 7, India

Shastri (trans.). *The Ramayana of Valmiki*. Shantisadam, London

Sivananda, Swami. *Concentration and Meditation*. Kundalini Yoga. *The Practice of Yoga*. Sadhana.

Snellgrove (trans.). *The Herdja Tantra*. Two vols., only one is trans. Other Sanskrit & Tibetan. Rider & Co. \$11.00

Taimni, I.K. *Gayatri—Daily Religious Practice of the Hindus*. Ananda Publishing House, Allahabad, India

The Science of Yoga. Quest pap. 1961 Theosophical Publ. House, Wheaton, Ill.

Tucci, Giuseppe. *The Theory and Practice of the Mandala*. Rider & Co. pap.

Tyagisananda, Swami. *Narada Bhakti Sutras*. Bharati Vijayam Press, Triplicare, Madras

Ramanar, K. Venkata. *Nagarjuna's Philosophy*. Tuttle \$10.00

Virajananda, Swami. *Paramartha Prasanga—Toward the Goal Supreme*. Vedanta Press, 1946 Vedanta Pl., Hollywood, Calif. 90028

Yuktiswar, Swami Sri. *Kawalya Darsanan, or The Holy Science*. Yogoda Satsanga Society of India, Ranchi, Bihar, India. 1963

Blake, William *The Penguin Poets*. Penguin Books \$1.25

Hesse, Hermann. *Steppenwolf*. NY. Holt Rinehard \$1.45 pap.

Magister Ludi. *The Bead Game*. A society of intellectual mystics develops a synthesis of all human knowledge and art. The story of the original Castalia. NY. Unger, 1964. \$2.25 pap.

Mayrink. *The Golem*. Ungar Pub. Co. 131 E. 23rd St., NY pap.

Saint-Exupery. *The Little Prince*. pap.

Schrodinger, Erwin. *My View of the World*. Cambridge Univ. Press \$3.50

Snyder, Gary. *The Back Country*

Tolkien, J. R. R. *The Hobbit, and the Ring Cycle*. Boston. Houghton & Mifflin. 1938. Also *Hobbit*. Ballantine pap. 67039. 95

Lord of the Rings. 3 vols. Fellowship of the Ring, Two Towers, Return of the King. Ace books pap. (A4,5,5) .75

ROSICRUCIAN

Rosicrucian. From Rosicrucian Fellowship, Mt. Ecclesia, Oceanside, Calif.

The Message of the Stars. Max Heindel

Rosicrucian Cosmo-conception of Mystic Christianity

Etheric Vision and What it Reveals

SUFI

Attar, Farid Ud-Din. *The Conference of the Birds*. Trans. of the Persian Poem by Mantiq Ut-Tair. Routledge & Kegan Paul Ltd., London.

Hafiz. *Fifty Poems with Translation*. Persian poetry. Ed. by Arberry, Cambridge University Press 1947, \$4.50

Meher Baba. *The Perfect Master*. C. B. Purdom

Avatar. Jean Adriel, J. F. Rowny Press, Santa Barbara, CA. 1947

The Wayfarers. Dr. Wm. Donkin.

Nicholson. *Rumi, Poet and Mystic*. Allen & Unwin

Purdom, C. B. *The Perfect Master*. The life of Sri Meher Baba.

Rice, Cyprian, O.P. *The Persian Sufis*. Allen & Unwin, 1964

Shabistari Mahmud. *The Secret Garden*. Trans. by Johnson Pasha. Octagon Press.

Shah Indres. *Tales of the Derwishes*. \$3.60 cloth. Order from Octagon Press, 3839 Dryden Chambers, 119 Oxford St., London, W.1, England

Singh, Jogendra (Trans.). *The Persian Mystics*. John Murray, Albemarle St.

The Invocations of Sheikh Abdullah Ansari. Verses by the 11th Century Sufi mystic.

SWEDENBORG

Spalding, John Howard. *An Introduction to Swedenborg's Religious Thought*. Swedenborg Publishing Assoc. 1966

Swedenborg, Emanuel. *Swedenborg's Works*. Houghton, Mifflin & Co. Riverside Press, Cambridge, 1967.

TAOISM

Legge, James C. (Trans.). *The Texts of Taoism* (in two parts) Dover, NY

Merton, Thomas. *The Way of Chuang Tzu*. New Directions, 1965. NY

Watson, Burton (Trans.). *Chuang Tzu—Basic Writings*. Col. Univ. Press

Wilhelm, Richard. *The Secret of the Golden Flower*. Harcourt, Brace & World, Inc., NY

THEOSOPHY

Besant, Annie. *Dharma*. Adyar Library, Theosophical Pub. House

Reincarnation. Theosophical Pub. House Adyar Madras 20, India

Blavatsky, Madame. *The Voice of Silence*. Theos. Press: Wheaton \$2.00

Computerdom is hard to enter. Why?

I can really sympathize with the people who are keen on computery and yet are frustrated by the "clean room" philosophy in most universities where you hand in your program through a slot and get the results back through another slot, two days later. Half the thing of computers is sitting in THE CHAIR watching the console and modifying the program and seeing the lights flash.

The college where I work has two computers (PDP-B/S, PDP-12) both by DIGITAL EQUIPMENT CORPORATION (Maynard, Mass.). Both are good machines, especially in a cost/performance comparison to the IBM behemoths. (We have a GE-405 behemoth which the business division use).

More and more high schools and colleges are purchasing the PDP series and there's a really good text available for anyone who can get near a PDP computer—

Introduction to Programming by the Digital Equipment Corp'n. (FREE!) (or \$2.50 maybe, depending on how you write them).

Somebody should sit down and write a really good book on how these things work. The best thing I've found so far is

Digital Computer Design Fundamentals, by Yaohan Chu, McGraw Hill 10800. Unfortunately the book has several deficiencies.

- 1) Published in '62, the book has much in it which is now obsolete (a lot from the fifties), and misses a lot of the new stuff (integrated circuits, for instance).
- 2) It's hardcover (approx. \$15)
- 3) It's a heavy trip. If you are super, super keen you could figure it all out but other wise you need background.

However, chapters 11 and 12 (Logical Design of a Simple Digital Computer and Arithmetic and Control Units) are really good and illuminate the computer's operation as a machine.

Which brings me to a point. These goddamn things are machines. Somebody down at St. Michael's college, here at University of Toronto was asking if computers have a soul and that sort of thing irks me no end. Like somebody in your government said (with reference to NIXON'S folly, the ABM system) "technology is riding us." People who think of computers as semi-human are people who can accept the computer's decision to launch missiles from North Dakota.

Back to Chu: borrow and Xerox is the best policy.

For background on the computer from a microscopic point of view (describing the bricks and pipes, so to speak) is

Digital Principles and Applications by Malvino and Leach (McGraw Hill)

or even better

Pulse, Digital and Switching Waveforms, by Millman and Taub (McGraw Hill). This, too, is a heavy trip (much math) but very cheap and accurate information. Well worth the fifteen bucks.

The trouble with all these bloody text books is that they cost between ten and twenty dollars, and the poor students keep the rich book companies in business.

Like the guy who turned me on to WHOLE EARTH says—all the neat books of the world are DOVER'S. Why doesn't Dover or somebody publish these books in paperback, at a price people can afford. (I mean modern, technical books).

Maybe I'll sit down and write the book myself. After I finish my present project, a TEKTRONIX type oscilloscope that anyone can build for \$100 to \$200 bucks.

Another thing. Somebody should build a computer using a DRUM or TAPE LOOP as mass storage. All sorts of these machines were built in the forties when CORE MEMORIES were really expensive. (In fact, Chu describes one). They bombed on the market because scientific and commercial users demanded a speed that the drums couldn't supply, and cores eventually superseded them. However, integrated circuits are now cheap, and many users such as schools and artists don't demand fantastic speed. It could be very, very cheap, I think, like hundreds of dollars instead of thousands.

Why doesn't Zomeworks build it?

Another thing: when people describe computers they usually start with this block diagram:

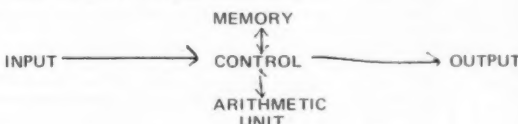

which is no help at all.

The computers I'm familiar with look like this:

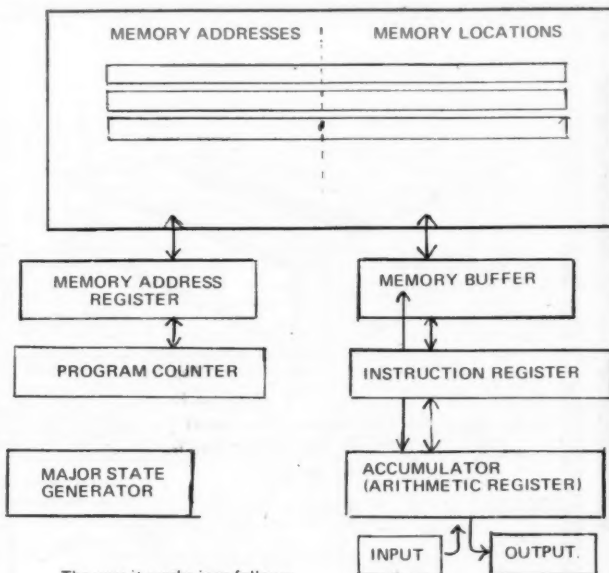

The way it works is as follows:

The major state generator is actually the controller of the machine. A computer program is placed in sequential core (memory) locations.

(e.g.)	200	START
	201	ADD 1 TO ACCUMULATOR
	202	ADD 1 TO ACCUMULATOR
	203	STOP

The major state generator has 3 states (simplified)

1. Fetch: an instruction
 2. Execute: that instruction
 3. Increment: the program counter.
- (repeat)

The memory address register specifies the location in memory that information is to be taken from or put to.

The memory buffer is where stuff—instructions and data—sits after coming out of or before going into memory.

The instruction register is where instructions are decoded.

The program counter tells where the next instruction is coming from.

I include all this because it was such a revelation to me when I discovered how simple it all was.

Pete Hiscocks
Computer Technology Dept.
Durham College
Ontario, Canada

EDUCATION Texts

Dibs Search for Self; Axline, Virginia

Growing up Absurd; Goodman, Paul

Compulsory Mis-Education; Goodman, Paul

The Community of Scholars; Goodman, Paul

How Children Fail; Holt, John

How Children Learn; Holt, John

The Authentic Teacher; Moustakas, Clark

Summerhill; Neill, A.S.

Freedom Not License; Neill, A. S.

Teacher; Warner, S. Ashton

Spinster; Warner, S. Ashton

Experiment at Berkeley; Tussman, Joseph

Death at an Early Age; Kozil, Jonathan

Report on High Schools; Conant

Sheepskin Psychosis; Keats, John

Supervision for Better Schools; Wiles, Kenneth

36 Children; Kohl

The Mission of the University; Ortega y Gasset

New Ways in Sex Education; Baruch, D. W.

New Ways in Discipline; Baruch, D. W.

One Little Boy; Baruch, D. W.

The Vanishing Adolescent; Freidenberg, Edgar

Coming of Age in America; Freidenberg, Edgar

Dignity of Youth & Other Atavisms; Freidenberg, Edgar

The Art of Loving; Fromm, Eric

Man for Himself; Fromm, Eric

The Sane Society; Fromm, ERic

Between Parent & Child; Ginott, Haim G.

The Conspiracy Against Childhood; LeShan, Eda

Educating Human Beings; Lane, Howard

Toward a Psychology of Being; Maslow, Abraham

The Schools; Mayer, Martin

Creativity and Conformity; Moustakas, Clark

On Becoming a Person; Rogers, Carl

Person to Person—The Problem of Being Human; Rogers, Carl

Summerhill, The Loving World; Snitzer, Herb

In Defense of Youth; Kelley, Earl C.

The Miseducation of American Teachers; Koerner, James D

The Way it Spozed to Be; Herndon, James

from:
New Schools Exchange
\$10/ yr (monthly)

2940 Hidden Valley Lane
Santa Barbara, CA 93193

Liquid wrench

Make your own liquid wrench (cheap)
¼ cigarette lighter fluid
¾ regular motor oil
the more lighter fluid the faster it works

Howard Sutherland
Berkeley, CA

Trail crotchets

If you find yourself in the woods on a rainy evening without dry ground, and not enough energy or light to set up a tent; try carrying a nylon knit hammock and a 6X8 sheet of sailcloth in a pocket of your pack. With two trees about eight feet apart you can drape the sailcloth in a V over your hammock, sleeping bag, pack, boots, whatever and stay completely dry the whole nite through. A space blanket works well for a covering too!

For back woods travel (and about grade 3 ARS) White Boot's of Spokane, Washington make one of the sturdiest boots I know of. They are generally referred to as loggers boots, and come with either vibram or caulk soles. I've had mine for six years and used them in all kinds of conditions; not even a loose stitch!

Dread pulling everything out of your pack at dinnertime? Try putting everything in "Baggies" and then letting them mold themselves into the shape of a Tupperware container. These strong plastic boxes fit perfectly in the compartmented Kelty Pack. Also good if you are concerned about concentrating the weight in your pack.

The Virginian
Pax River, MD

P. S. Can anyone fill me in on vinyl cements?



How to Start a High School Underground Paper

A remarkable practical little manual on this subject is available (free? send postage at least) from:

John Schaller
530 N. Brainard Street
Naperville, Illinois 60540

It has a lot of stuff I wish I'd known when we started the CATALOG

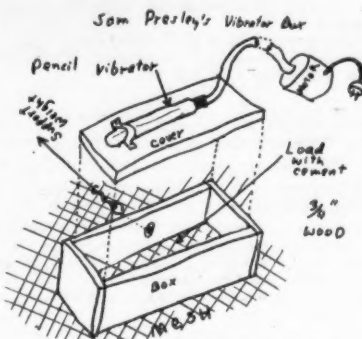

Vibrating cover forces cement thru mesh like hypodermic needle.
Start box at top and move down.
Men inside stop cement with trowels and check penetration.

ADVANTAGES OF FERRO-CEMENT

- Less Critical building techniques
- Cheap
- Waterproof
- Few Tools needed
- Adaptable to many forms
- Multiple (land-sea) uses
- Variation in materials that can be used
- Easily obtainable materials
- Lasts

- No strange chemical or pollution hang-ups for workers
- Sound absorbent
- Relatively inert
- Fireproof
- Can Be drilled
- Flexible (really)
- Easily repaired
- Gets stronger as it gets older (for first 50 years)
- Does not break down under sunlight

Derek Van Loan
Sausalito, California

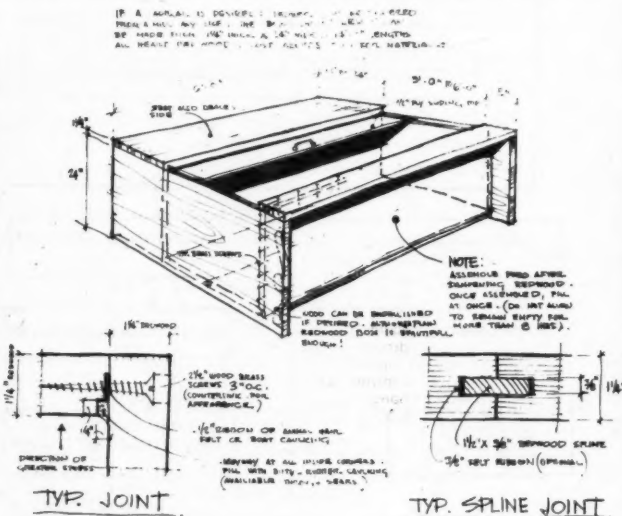

Communal Bath

We have been using a "Furo" (Japanese Bath) or (Japanese Bath Ritual) for some time here in Hawaii. The Furo is as old as fire itself for it consists of a large body of hot water and a bucket! The basic principles are as follows:

1. Wash by first wetting oneself with a bucket of water outside the tub.
2. Soap up luxuriantly with soap (as in a shower).
3. Rinse with another bucket of water.
4. Then slip into the furo for a therapeutic spacious bath in sparkling clean water of about 100° Fahrenheit.

The unique advantages of this method of bathing are many. However, the most important are—water economy (5 to 10 gallons per person), the ability of a furo to accommodate several bathers at one time, the establishment of communal bathing rituals so important for the spirit as well as the body.

The sketches and details I've enclosed are one cheap and simple way to build a Furo for a community. If manufactured fuel is not readily available, a copper bottomed Furo can be built for wood or coal heating.

If additional information regarding the construction of communal baths is needed, please write to CBS and Associates, Inc. and we'll be glad to help in any way possible. Also, any suggestions, improvements or information on other existing installations would be appreciated.

Aloha,
Nick Carta
P. O. Box 1041
Kealahou, Kona, Hawaii 96750

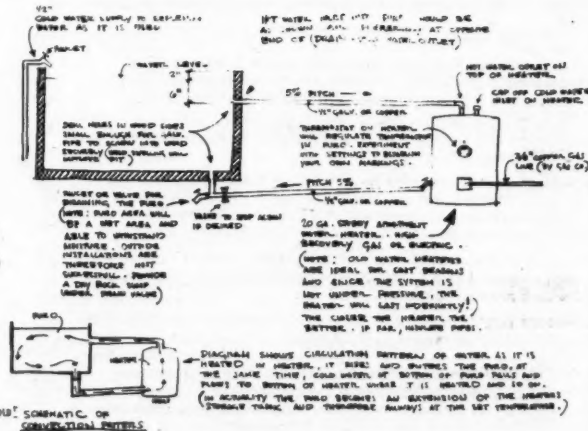
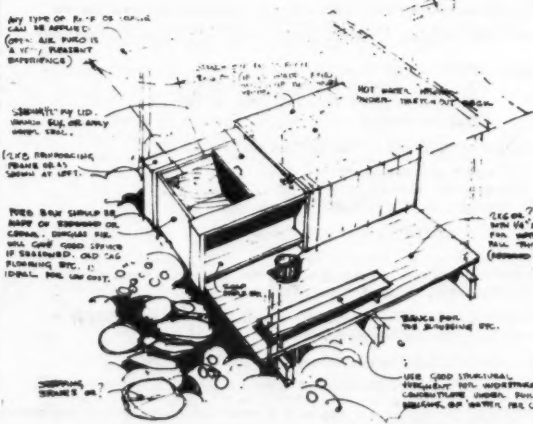

Breakfast

We've made up a breakfast cereal which makes a great hiking food.

rolled oats	5 cps
All-In-One	3 cps
soy groats	1 cp
toasted buckwheat groats	1 cp
sunflower seeds (hulled)	1/2 lb
coconut (unsweetened)	1 cp
raisins	2 cps
dried apricots (chopped up)	hand full
dried apple bits	1/2 lb

This will make about 16 cps of cereal which is enough for 2 people for 8 days. For hiking add several cps of brown sugar so you don't have to carry any extra sweetener.

All of the measurements are variable. All-In-One is a cereal from Foodmill—which has Whole Wheat, Oats, Corn-Rye, Barley, Wheat germ and Flax. The seven-grain cereal from El Molino Mills is similar and more expensive. We usually get everything from the Foodmill in Oakland.

Cook 1/2 cp of cereal with 1-1/2 cps of water and some salt for 5-10 mins. Eat with honey and milk.

Challenge makes a dried whole milk which is good for camping.

To make a good yougert for about 25-30¢ qt.

- mix 3/4 cps whole milk with 1/4 cp dry milk
- heat to 150° (about). let it cool to 110°
- mix in 1 tbl yougert starter. The Bulgarian Yougert makes a good starter.
- cover the container and place it in a box which is insulated with foam. Let it sit for 4-8 hrs. It should not be jiggled or placed on a slant during this time. The longer the incubation period the more sour the yougert will be. Mix a teaspoon of jam in with the dish of yougert to give it a flavor. Save a tbl. for the next batch. The starter shouldn't be over 5 days old or the yougert may be watery.

Also, the yougert might get lumpy if too much starter is used.

Laura Line
San Rafael, CA

Bread

At Tassajara we dig your catalogue and supplements. Here is a possible contribution to use as you wish, the favorite bread from our kitchen noted for its good bread. Its chewy, and un-sweetened, un-yeasted

Bill Shurtleff
Tassajara Zen Mountain Center
Carmel Valley, CA

TIBETAN BARLEY BREAD (2 loaves)

4 c Barley flour	4 T Sesame oil
8 c Wholewheat flour	4 T corn oil
3 t Salt	7 c Boiling water
1/4 c Sunflower seeds	4T Tahini
1/2 c Roasted whole sesame seeds	

TO PREPARE

1. Pan roast barley flour in 2T oil (1T sesame and 1T corn) until darkened
2. In large bowl add 8 c wholewheat flour to 4 c barley flour. Add salt, sunflower seeds and sesame seeds. Mix.
3. Add 3 T each sesame and corn oil. Thoroughly mix by rubbing flour between palms of hands.
4. Add 7 c boiling water and mix.
5. Add Tahini, mix in, let cool 10-20 min.
6. Knead in bowl then knead well on board
7. Force into loaves and press into oiled (sesame and corn) warm pans. Cut 1/2" deep slit lengthwise down top. Let sit 3-6 hours or overnight.
8. Bake at 450° for 40-60 min.

Purchase of Whole Grain Products and Beans

Items such as brown rice, whole wheat flour, wheat germ, cracked wheat, rye flour and dried beans are available at most supermarkets, but they are cheaper at farmers' co-ops and feed and seed dealers. To locate one of these outlets, check the yellow pages under headings Feed Dealers, Seed Dealers or Grain Dealers.

Here's a comparative list of prices obtaining now in the Pacific Northwest. Obviously availability and pricing will vary locally and regionally.

Item	Supermarket price per pound	Feed Dealers' price per pound
Brown rice	25¢	18¢
Wheat germ	50-75¢	20¢
Whole wheat flour	14¢	10¢
Whole wheat flour	14¢	10¢
Rye flour	20¢	10¢
Pinto beans	25¢	16¢
Small red beans	17¢	17¢
Large red kidney	33¢	33¢
Split peas	21¢	17¢
Pearl barley	25¢	14¢

Marilyn Thompson
Eugene, Ore.

Survival book, Jr.

A quirky latter-day boyscout manual called *Syllabus of Survival, covering Perception, Shelter, Fire, Food, Water, Sanitation, Sleep, Creation, Meditation, Responsibility*, is offered for sale for \$5 by:

T. D. Lingo
Adventure Trails Survival School
Laughing Coyote Mountain
Black Hawk, Colo. 80422

Hydroponics (Aquiculture)

The following is excerpted from a fascinating report by *The Toronto Youth Project*, sent to us by:

Larry Williams
Toronto Youth Project
393 Spadina Avenue
Toronto 130, Ontario,
Canada

Fertilizer grade chemicals provide all plant nutrients. Costly pharmaceutical grade chemicals, as used in plant research lab growth chambers (hydroponic method), provide a degree of control which would be excessive for crop production. Plants thrive in any of the various food solution formulas. Plants practice selective absorption and adapt to different formulas as they do to different soils.

Only a few controls over the conditions of plant growth are necessary to produce crops hydroponically. All nutrients must be continuously in solution; test for the presence of each ion are simple and inexpensive. A steady pH of the solution must be maintained. The root medium must be kept warm. Roots need air; no more than a small aquarium pump is necessary. The nutrient solution must not contain injurious substances such as fluorine or selenium; tests are simple and inexpensive. Growth of algae and other flora and fauna in the solution is prevented by the pH and darkness. With careful gardening any amateur (amateur means lover) will find plants in hydroponics doing what plants do, only very well. (See Gericke for elaboration).

Support for plants is provided either by 1) an aggregate in which the plant takes firm root or, 2) a combination of wire mesh, support trays, strings and poles, so the plant roots dangle freely in the nutrient solution. Gericke has a complete comparison of these two approaches. We are presently considering the suitability of light-weight mineral aggregates (not known in the 40's, and not used recently) and traditional cropping techniques.

Sunlight can be simulated. Theoretically, an ordinary incandescent bulb supplies the full spectral range necessary for photosynthesis. Incandescent bulbs alone, however, are too hot in relation to their light output. A combination of cool white fluorescent and incandescent fixtures have proved to promote growth maximally with no damage from heat. There are to date, however, no reports of crop yields for artificial lighting. . . .

In regions of short growing season and cold or other excessive conditions, hydroponics has considerable advantage over ordinary greenhouse methods. Soil or compost has to be hauled into the greenhouse at least once every two years presenting all the problems of the field: pests and soil disease. When soil disease (some species of every form of life: fungie, algae, bacteria, viruses, insects, people damage the growth and function of plants) is severe the greenhouse must destroy all plants—or make them inedible with pesticides, in addition to sterilizing the soil there or replacing it once again. Sterilization of soil or compost by steam is costly and tricky because beneficial organisms which break down chemical compounds making some elements and materials available to the plant must remain alive. In hydroponics, these elements are already in solution. Soil must be fertilized regularly and the costs for fertilizers alone can exceed the cost of chemical nutrients used in hydroponics. (See Hollis). . . .

Ordinary greenhouses require heavy labor, professional management, and costly maintenance. One man could manage, handle the equipment, and care for the plants of a fairly large hydroponics operation; one capable of providing 10 people with nutritious, pesticide-free food year round. Our research is intended to develop the technique in this direction, to find the newest and most commonly available materials, to include all the advances since Gericke, and to innovate constantly. Note that the figure of one man feeding ten from his hydroponic garden is for a few hours attention per week.

Growth in hydroponic is exaggerated growth, it is not the freaky growth of plants given additional hormones. Only those chemicals which are food to the plant are provided in the solution; they are the same as in soil. Root development in hydroponics is unusual. Roots and root hairs proliferate and have the appearance of a sponge. Plant nutrients are always available to the plant. With the appearance of any deficiency system, that deficiency can be checked by the addition of the particular nutrient salt of the solution. For these reasons yields of hydroponics will always exceed (however narrowly for some crops, like tobacco) yields of the best soils. For, not only is the medium liquid in the form it must ultimately be in soil, it can also present changed constituents to the plant sooner and with smaller total amounts of constituents.

BIBLIOGRAPHY

The Complete Guide to Soilless Gardening
W. F. Gericke
Prentice-Hall, Inc.
New York, 1940

Gardening Without Soil
A. H. Phillips
Chemical Publishing Co., Inc.
New York, 1940

Growing Plants Without Soil
Maxwell Bentley
Hydro-Chemical Industries (Pty.), Ltd.
Johannisburg, 1955

Profitable Growing Without Soil
H. F. Hollis
English Universities Press, Ltd.
London, Great Britain, 1964

Sand and Water Culture Methods
E. J. Hewitt
Commonwealth Agriculture Bureau
Farnham Royal, Bucks, England, 1966

Chemical Gardening for the Amateur
Connors and Tiedjens
W. H. Wise and Co.
New York, 1939

Growing Plants in Nutrient Solutions
Wayne Turner and Victor Henry
Chapman and Hall, Ltd.
London, England, 1939

Dome math

I have a few comments to add to your review of "Geodesics", by Edward Popko: the pictures are beautiful and the examples diverse, but they are mainly industrial enclosures and large public buildings. Domes for small groups of people get rather short treatment. The angles and chord factors are given only for the "triacon breakdown" which is the least useful type for small domes.

The equator of a triacon dome does not coincide with any members, so you need to build a special set of triangles at the base. Prof. Popko points this out, but doesn't give the parameters of the so-called "alternate" dome, which does not have this disadvantage. The parameters for 2 and 4-frequency domes of this kind are written down on the enclosed figures. The numbers are obtained from routine, unpatented analytic geometry. The figures show how a face of an icosahedron is "broken" into a dome section.

Also, there are useful descriptions of other kinds of domes given in a book by B. S. Benjamin, "The Analysis of Braced Domes" (Asia Publishing House, N.Y. and Bombay, 1966).

Sincerely,

Robert Ellsworth
Washington, D.C.

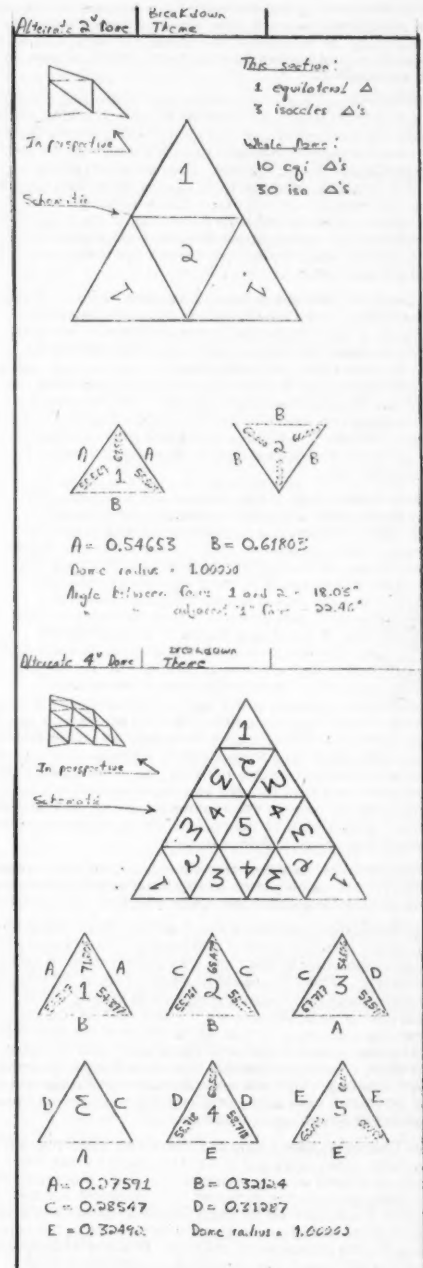

Vegetarians disregard

You might pass on that the government will pay you not to grow crops or raise pigs. You can buy 3 piglets raise them to 8 months of age, breed them & end up with 12-16 in each litter (36-48 total) rather than selling them tell the proper government official you will breed them up to 500 & uncle Sam will pay you about 1/3-1/2 of what you would make to not breed them. Then you take the baby pigs, raise them until they are 3 1/2 months old & slaughter them yourself. You can sell the skins when cleaned for \$10-15 apiece or trade it off and put the different meats into a homemade smokehouse & smoke the meat for a couple of weeks. Voila! 3000 lbs of smoked bacon, ham chops, roasts etc. that need little or no refrigeration. that will hold you for feeding a magic mountain eat-in-plus.

Michael McAuley
Chicago, Ill.

Canada

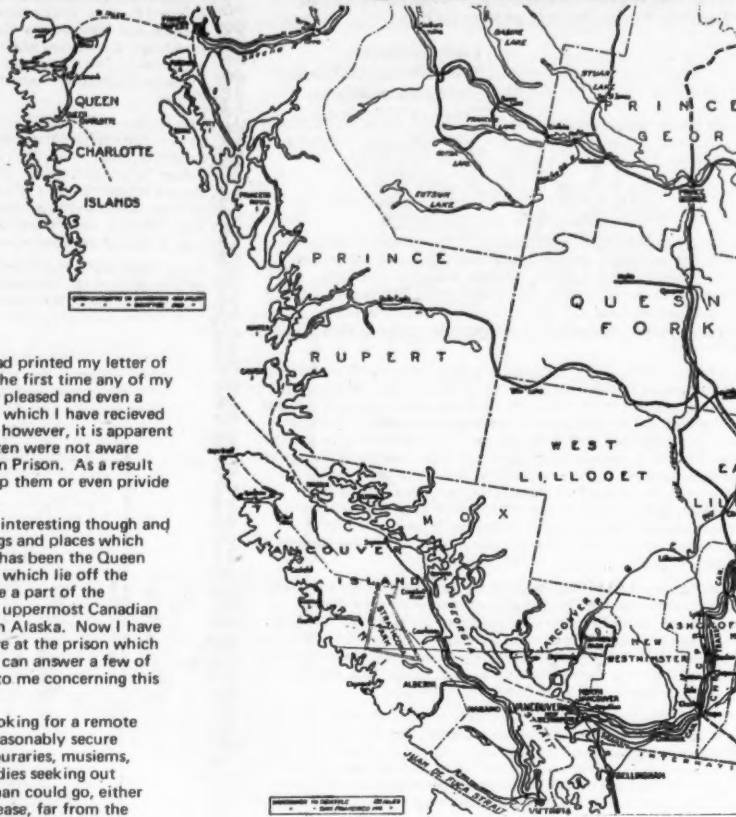

Island Fantasy, in depth

I was surprised and pleased to hear that you had printed my letter of June 20, 1969, in the "Supplement." It was the first time any of my writing had appeared in print and I was quite pleased and even a little flattered. Some of the letters of enquiry which I have received as a result of this printing are very interesting, however, it is apparent to me that most, if not everyone, who has written were not aware that I am a prisoner of the state in San Quentin Prison. As a result I am somewhat limited in what I can do to help them or even provide them with information.

Some of the enquiries I have received are very interesting though and show considerable interest in some of the things and places which I mentioned. At the forefront of this interest has been the Queen Charlotte Island group which I mentioned and which lie off the West coast of Canada about 70 miles. They are a part of the Province of British Columbia and make up the uppermost Canadian island group before you run into South Eastern Alaska. Now I have very little research material available to me here at the prison which concerns this area but perhaps from memory I can answer a few of the many questions which have been directed to me concerning this paradise of the northwest.

When in Canada in 1965 as a fugitive, I was looking for a remote place where I could find a new home and be reasonably secure from discovery. I spent many long hours in libraries, museums, archives, and in university laboratories and studies seeking out every secret and hidden area in Canada where a man could go, either alone or with others, and live with reasonable ease, far from the intrigues of our cities and society in general. After nearly five months of looking and having to evade the Mounties on at least one occasion, I finally decided that the Queen Charlotte Islands (on really old maps they appear as the "Washington Islands") would be my best bet.

Having found a place to go it was necessary to determine just how to get there as this area has only limited contact with the outside world. Albeit this contact is on a regular basis and can be generally depended upon. I found that there is a regular steamer service out of Vancouver which lands at Skidgate City on Graham (the North Island of the group) about once every week. There is also the inland passage shipping route from Vancouver to Prince Rupert which will take you there in class for a very high fare. From Prince Rupert it is then only 70 miles to Charlotte City which is also on Graham and from which it is reasonably easy to get a fishing boat to give you passage across the Hecate Strait. There is also a sea plane service which lands at both Skidgate and Masset and because of the traveling time by other means this may well be the most economical way to travel from Vancouver to the islands. You may also drive the Alaskan highway and take the Prince Rupert cutoff, although it is a bit of a rough road and you must be able to make your own repairs in the event of a breakdown. As a final thought you could possibly hitch a ride as a paying passenger or even a workalike on one of the many fishing trawlers heading north out of Vancouver. To my knowledge there is no direct train or bus service to Prince Rupert.

A few of the pertinent details of this island group which I remember will now follow in the remaining body of this letter as will a somewhat incomplete bibliography which the reader may find to be helpful.

The Queen Charlotte Islands have a land area of about 4,000 square miles and are occupied by about 3,000 people, mostly Haida Indians. There are two high schools that I can remember, one at Skidgate and one at Masset. There is a paved highway of about 68 miles in length between these two towns and numerous logging roads. Fishing and lumbering operations are the best sources of a cash income and wages are good in both fields. Most of the approximately 500 white residents are located at Skidgate and this is the most important town. There is a R.C.M.P. Station at Sandspit and to the best of my knowledge this is the only law enforcement agency in the area. The only hotel I am aware of is at Skidgate and most other general services originate out of this town.

The Queen Charlottes have a long and interesting history which is still being made. They were and still are occupied by the Haida Indians who developed what is probably one of the most successful hunting, fishing, and trading societies in N. America. According to old records it was possible for these people to gather and prepare for storage in three months, enough food to feed the entire community in high style for the remainder of the year. This was so back in the 1800's and it is still true today despite the encroachments of "civilization."

There is available from the National Geodetic Survey and Mining Office in Ottawa a set of 44 topographical maps which literally cover every inch of the island group. Every spring, river, creek, lake, ore deposit etc. is covered in marvelous detail as are all of the man made features in the area. This set of maps cost \$22 but is a must for anyone interested in going to the area for more than just a superficial visit. The many navigational charts of the area, also available from the National Geodetic Survey and Mining Office, are a worthwhile investment and a must for the boat owner.

I am of the opinion that the Charlottes, as a wilderness area still undeveloped, have far more to offer those individuals who are of an adventurous nature than any other area I know of. Providing of course that you are willing to adapt yourself to the special features of this island paradise and not just try to change it to suit yourself. It does rain a lot and for those who like a completely dry climate, all I can say is, stay home! It is a type of precipitation which is easily endured and may be loved by many, especially some asthmatics. Don't let the weather discourage you, however, for it seldom rains hard enough to need the usual rain gear and a good wool shirt will shed most of what falls.

There are numerous wilderness locations for building community settlements, cooperatives, or communes which are unmatched for beauty anywhere and which may be had for such a low price as to seem unbelievable. There is an abandoned whaling station on Naden Harbor, a six mile long natural harbour on Masset, which would make an excellent site for a commune with room to grow to about 2,000 people and no one would be crowded. No one lives on Naden harbor at this writing and it is 30 miles by boat to Masset. The nearest neighbours are on a small island named Langara I. about 20 miles north and west. I have forgotten just how many Indians live there but they occupy a historic village site and in my opinion would be good neighbours. There are fresh water springs and creeks in this area which feed into the Harbour. There is also ample grazing pasture and brush for a good size goat and sheep herd and a part of the area is also a wildlife sanctuary for migratory water fowl.

The harbour is deep enough for ships with up to a 30 foot draft and is calm and easily navigable by small boats. This harbor is remote and beautiful and is my personal choice of a place to live away from the troubles of the world but, a good boat is a must and this may not be an easy item for an individual to acquire without considerable funds. For a commune it would probably be easy enough to get one of the canneries to finance a boat for you and even train your crew. Some of the best halibut fishing in the world is just outside of Naden Harbour and you would be able to pay off the boat in no time. Gardening is also possible on land cleared of brush and trees near the old whaling station which is located on the west shore of the harbor on the estuary of a small salmon stream midway between the mouth and the head of the harbour. Beekeeping, poultry, etc are also good possibilities here.

A much easier place to locate a settlement on and much nearer to community services, including electricity, is on the south shore of Masset Inlet which is also on Graham I., about 26 miles east of Naden Harbor. This sound is much larger than Naden Harbor and much different. It is bottle shaped with a 1/2 mile wide channel leading down from the North to its inland body of water. It is quite a beautiful place and lies about midway between Skidgate and Charlotte City. The South shore has been cleared of trees and there is a large pasture like area which was previously used as a recreation area for one of the large lumbering companies. There are also some buildings here which were not previously being used (I don't know their present status) which belonged to the forementioned lumber company. The prevailing attitude in the North West has been that it is better to have your buildings occupied by "anyone" rather than stand vacant and it might be possible for a group to buy or lease this whole area for a pittance. The natural resources of this area are extensive and you have access to the main highway by a good road. From the Inlet it is just a short drive to town. There are giant crabs to be had in the sound along with the usual fishes etc. There is also a herd of wild cattle in the area should you prefer beef and elk, a herd of about 600, exists just to the west of the Inlet. The local limit on deer is one per day per person every day of the year and you usually need go no further than the nearest beach to find several.

Otter and bears will sometimes be encountered on occasion and tend to be, along with raccoons, about the worst nuisances to be encountered throughout the entire area of the island group. Aside from brown and black bear there are no major predators on any of the islands so the woods remain relatively safe for livestock. Some poultry and honey bees will fall prey to skunks, however and this is to be expected. Hives must also be protected from the bears. Any surplus of either products will find a ready market in town or the lumber camps at the highest possible prices.

Back in the 1930's a group of about 200 Russian emigrant farmers settled on the east shore of Graham. They cleared farms out of the brush land and bush. A few years later they abandoned these farms and moved to the mainland and closer to "civilization." There is today only one farm left on Graham and this in spite of the reputation of the area for producing 10 tons of potatoes to the acre: The abandon farm sites can now be bought for almost nothing and reclaimed for the cost of your own labour. As I recall they average from 40 to 60 acres in size and could be bought for about \$5.00 an acre or less. There may even be some homesteading sites left to be filed upon if you are interested. The major drawback of this area is the lack of small harbors where boats can dock. This means that boats must be pulled completely out of the water when not in use lest the choppy seas of the strait beat them to pieces.

To the south of Graham I., just off the coast of the long, mountainous, south island there lies a large island of about 25 square miles which has some unique characteristics and on which a commune organized as a resort operation might find considerable success. I think the name is Louise Island. This island which is covered mostly with forest has a number of mineral hot springs which feed several small lakes and there are also tar pits and asphalt deposits to be found as well. Game is also abundant and some minerals may be found. It is only a short boat ride from Skidgate to the island and its possibilities are only limited by the resources and imagination of its colonizers.

There are numerous other possible locations for settlements throughout the entire group of islands but I will have to leave it to those who are in need of a place to settle to find them. I do not even have a small map of the area to refer to for further details so perhaps you can appreciate my predicament. For those who want to remain in the U.S. though I will suggest a look at the town of Craig on Prince Edward Island in S.E. Alaska. There exists also an infinite number of sites where individual dwellings could be built from native materials at almost no cost other than your time and labour. If you just squat upon a piece of land in this area it is quite unlikely that anyone will bother you unless you just plain over do it and get into everyone's way and generally make an unwelcome nuisance of yourself.

It is not difficult to live from the land in this paradise as I have already stated. There is also, however, work to be had in the island industries paying about \$30C per day. For group investments you might get a Japanese firm to finance a fish storage locker or cannery operation for you and home crafts are a definite possibility. A ready market also exists for any surpluses from your gardens.

A marvelous thought occurred to me while answering a letter from another reader concerning the Charlottes and I will try to pass it on to those of you who may be interested. As I have already mentioned, the Indians of this area had a highly developed culture at a very early date, having to work only three months of the year to earn their subsistence from the land and sea. Inasmuch as these Indians lived in large community dwellings which were erected with the resources of the occupants perhaps they have already laid the best foundation plans for establishing communes, cooperatives, or communities for this area. When the Indians built one of these community houses everyone who was to live inside contributed lumber for its erection, but they retained ownership of this lumber and should they move or be thrown out could take it with them. These people were both capitalistically oriented and socially conscious. They worked individually and together depending upon the nature of the project and property rights were a sacred matter to for both individuals and the whole tribe. This is still true. Inside the houses were partitioned off with each family having a room or area with the central part of the house being used for cooking. A modern version of this same thing would work quite well for the initial structure for a group attempting to establish itself in the area and later individual homes on the same lines and pattern could be built. An interesting psychological point worth noting here is that in the Indian method of ownership no one would want to see a portion of the roof or walls belonging to a fellow tribesman removed and this no doubt contributed considerably to the spirit of community cooperation and individual consideration. It was simply to everyone's advantage to preserve harmony within the house lest it be literally torn apart by its owners and rebuilt someplace else by the divergent factions. A friend of mine named Bill Holm who can be reached through the University of Washington Press, Seattle, Washington, built one of these Indian houses with volunteer labour and milled lumber in the San Juan Islands of Puget Sound for a cost of about \$3,000. This house was about 35' x 70' as I remember but they are sometimes much larger and could be smaller if desired. It sits on land belonging to a private camp and is quite well done and I think that anyone who is interested could get further details from him or the University of Washington Publications on the subject. Another similar house was built by Mr. Mungo Martin at Thunderbird Park in Victoria, B.C., and photographs and details are available from the park curio shop. You can also collect \$70C a month in Social Assistance from the Government for everyone in the community if they don't have jobs or just won't work.

My thought for this proposed commune or community project is a little different from the motivation behind the two houses I just mentioned. A family, family group, or larger unit of individuals coming together in the Charlottes for this project would be able to accomplish the house and housing project with little more than an "Alaskan saw mill" chain saw, a couple of adzes, and the other and more usual tools of carpentry. For those who don't know, an Alaskan sawmill is a two man chain saw which is generally operated by three men. You walk it down the length of a squared log and a roller device determines the thickness of the board or slab to be cut. These boards should be adzed smooth for painting when used on the front or inside of the house but the sides may be left rough. As you can see a house could be started in the most primitive fashion and still become just as modern as you like. These large houses will shelter quite a few people in the beginning and as individual families grow and require more room the community can contribute its efforts to build each family the basic framework for a house and leave it to the occupants to decorate and improve upon it to suit themselves.

Between pages 288 and 289 on Plate XIII in "Primitive Art" by Franz Boaz, Dover Publications, Inc., N.Y., 1955, there is a photograph of the framework of one of these great houses. Further details may also be had from the publications of the Museum of the American Indian, N.Y. City, The Denver Art Museum, 1300 Logan Street, Denver, Colorado, Washington State Museum, Seattle, Washington, the Chicago Museum of Natural History, and the Smithsonian Institute, Washington, D.C. There are other U.S. sources but these will do for a start. If you are in Canada the museums in Vancouver, Victoria and Ottawa will be most helpful and have some excellent material.

When you research and study these houses don't make the mistake of stopping there. Examine the lives and culture of the people as well. They have already set a splendid example in developing a completely unique culture and a mode of living much of which is well worth doing again in this modern day. A word of warning is also due for the cultural explorers among you. The Haida are a proud people, jealous of their heritage. Learn their customs before you approach them and do not be presumptuous or paternalistic. Most of them make exceptionally good livings from the sea and probably don't need anything you have to offer. Don't use old totems and designs of the area without getting permission of the family who owns that design first. They may be flattered by your request and give you the free or limited use of the design; they may refuse absolutely to let you use it or; offer to sell it to you. In each case it is quite according to their traditions and their wishes should be respected at all cost.

The art of the Haida, like everything else about them is unique and worthy of your interest and use. I hasten to refer the reader to the forementioned book, "Primitive Art," and also to "Northwest Coast Indian Art; An Analysis of Form," by Bill Holm, University of Washington Press, Seattle, Washington, 1965, 1967, \$7.50. There is no finer study into the form and style of this art and I highly recommend it to any artist for further study.

Anyone who has read this far and who is seriously considering the move as I have suggested will do well to make considerable preparation in this country and in Canada before finally embarking. Take everything with you that you can in your first trip. Upon entering Canada as a landed emigrant you are allowed a considerable amount of duty free goods which is quite an advantage to you. I would suggest that you bring all of your personal clothing, furniture (maybe), and equipment and vehicles if possible. If you plan to garden or farm you will be wise to bring your own rototiller (I suggest the large Aarens or Howard Rotovator) and such other power equipment as you have or think you will need. Many of these things are cheaper in the states and you might find a good used piece of equipment for sale at a low price here, in the Charlottes you won't. A car, jeep, truck, or if you wish, a horse and buggy are all in order. A boat, Kiyak, or seagoing Canoe are all in order but you can buy or build them in Canada just as well as here. For the nomads among you a two man kiyak of the "Kittiwake" pattern as described in "Canoes and Canoeing" by Percy Blandford, Lutterworth Press, will be of especial value as they will carry 850 lbs. with no strain. Outfitted in any one of the possible ways, this type of boat will be a real joy to have. A commercially built boat which is almost as good may be had from Klepper of Germany. See a boating or sports shop or magazine for more details.

As I have stated, wool clothes are a must, but don't buy any until you are there, then let the circumstances dictate the nature of your purchase. The Hudson's Bay Co. Catalogue can supply many of your needs but so can some of the Indian women who knit wonder natural wool garments which will shed quite nicely the occasional light rain. These garments are sometimes called Cowichan sweaters, caps, mits, etc. Keep in mind that it seldom if ever goes below 30 degrees throughout this area and a couple of wool blankets or a down comforter are just about all you will need for bedding.

Anyone planning to camp out at the start will do well to bring an A shaped tent with one or better, two, over fly tarps as tents tend to become soggy if continually exposed to light showers over a prolonged period of time. There is an excellent open front half shelter illustrated in the back of "Alaskan Adventure" which would make a perfect shelter for most campers.

The small one burner Coleman stove will be best for cooking if you can't afford the extra shipping weight of larger stoves and once established you will be able to get something better. A good lantern or the kerosene lamps listed in "The Whole Earth Catalogue" will also be desirable items to bring. A hint here, if you don't like the smell of kerosene then burn pearl oil which is produced by Shell Oil Co. and is just a deodorized kerosene.

After arriving in the islands and selecting a location, get started, build your house and start exploring the possibilities of the area. The Queens Printer, Ottawa, Ontario, Canada, has printed a two volume set of books just dealing with the plant life on the Queen Charlotte islands. The vegetarians and nature lovers among you will love it.

The University of California at Berkeley or Davis have printed material on how to build an anaerobic compost for disposing of animal or human feces and producing natural gas for cooking and heating, when the matter is spent it may be safely applied to the land as fertilizer. These composters if properly built and operated should be perfect for the operation of each large "Clan" house and I think may produce all of your cooking and maybe most of your heating needs.

Examine the possibilities of using material in "Japanese Homes and Their Surroundings" by Morse, Dover Pub., for aids in making the interiors of your houses as livable and comfortable as possible.

Make the acquaintance of the R.C.M.P. representative in your area and let him know something of what you plan to do. This is better than arousing their curiosity and having them snooping around trying to find out what you are up to.

Find out whom among the locals both white and Indian that you can depend upon for help and advice. Don't waste any time getting to know your new home. If you have hard times when you first arrive you may apply for and receive Social Assistance from the government for each member of your group in the amount of about \$70C per month.

Aside from vast forest and a tremendous wildlife population there are also gold, iron, coal, argelite (a form of slate), and other mineral deposits which will be useful to you. Get a good and BIG dog and keep it with you in the bush but train him to deal with bears first.

A good 308 caliber rifle will be an asset but the small over and under 20 gauge shotgun and 222 rifle combination currently available in all firearms outlets will meet most or all of your needs for getting pot meat. Pistols are generally frowned upon in Canada and you don't need one anyway.

Aerial photographs are available covering the whole island group from the forementioned Geodetic office so if you are in doubt it will only cost you a few cents for a picture of any objective you may have in mind and the office will enlarge specific areas to suit your needs and your detail requirements. No area need be entered without a fore knowledge of just what it holds.

Those among you who consider yourselves "Indian traders" will do well to include a large supply of Blue abalone shells and 1/4" to 1/2" white shell buttons in your barter bag for use as gifts and for trading goods. These Indians sometimes use several pounds of pearl buttons to decorate a blanket for use in the winter pagents held in the community dance houses.

If you plan to keep goats and I think you should then by all means send \$3.00 to the "Dairy Goat Journal," P.O. Box No. 837, Columbia, Missouri 65201, and get their literature. There are already a number of B.C. goat keepers who advertise in this publication and who will be only too glad to supply your needs. One of them is, Alpine Meadows, Mrs. Irene McDonald, Rt. 5, Langley, B.C., Canada, 7581-209. Although I am fond of the Nubian goat it is possible that some of the other breeds would be better suited for the Charlottes. Perhaps the French Alpine, Toggenberg, and maybe the Saanen would be the best for milk and perhaps the angora would be worthwhile for its wool if it likes the climate of the area.

Now, if I can be of further service to anyone interested in this project I stand ready to act in the capacities of adviser and coordinator for forming groups for commune or cooperative projects. Just address me at the above address and I will answer you at my earliest possible convenience. A word of advice, it is not likely that either the white or Indian population would make a negro welcome in the area and I don't encourage anyone to encourage such unwelcome emigration.

I am very interested in seeing something done of a worthwhile nature in the Charlottes and may move there myself when I am finally released from this prison. I am also interested in material concerning the Charlottes and anyone who has any publication, book, map, or pamphlet which they do not have further use for I would be grateful if you would send it to Rabbi Traub, Jewish Chappel, San Quentin Prison, Tamal, California, with a letter inside stating that the inclosed material is for me. Although I am not Jewish this kind man preforms

this service for me as otherwise all material sent to me would simply be destroyed. I am also interested in other community projects and any old literature of this sort which is no longer needed will be warmly recieved and will be widely read as there are others here besides myself who are interested in this sort of project and we share our information, freely.

At this writing I am also preparing a paper, later to be published as a book, dealing with the material contained here. It will expand upon this project considerably and go into details concerning the workings of the community projects which I have mentioned here and it will in so far as my resources and research material will allow paint an accurate picture of what can be or is being accomplished by the participants for themselves.

I hope to provide maps house plans, boat designs and clothing requirements as well as information on virtually every other aspect of this project. This will be needed by the modern day colonist in order to make a success of establishing an organic community at one with its surroundings and a part of the ecology. This outline is understandably brief and my research limitations have, unfortunately, limited it more than I would have liked but, for the serious minded among you who would like to pursue the matter further I offer the following bibliography which is itself quite limited in its scope but potentially useful and through it considerable expansion of the contents of this article may be made. Feel free to write and express yourselves if you feel you have something of value to offer but please try to give as many details as possible and be specific to details.

- Basketry of the Tlingit, Memoirs of the American Musiem of Natural History Vol. 3
The Chikat Blanket, Memoirs of the American Musiem of Natural History Vol. III
Indian Silversmiths on the Pacific Coast by Barbeau, Marius Haida Carvers, 1957, Anthropological Series No. 8, Bulletin 139, National Musiem of Canada, Ottawa.
Native Arts of the Pacific Northwest, Robert T. Davis, 1949, Stanford University Press
Report on the Queen Charlotte Islands. Geological Survey of Canada, Report of progress for 1878-79, by G.M. Dawson.
The Whale House of the Chikat, Musiem of Natural History, Vol XIX
The Art of the Northwest Coast Indians, Natural History, Vol. XXX. Making a Bird or chiefs' Rattle, Davidson Journal of Anthropology, Vol I, No. 2, 1955a
Indians of the Northwest Coast, Erna Gunther
The introduction of Monetary Shells to the Indians of the Northwest Coast, Heizer, Robert, Pacific Northwest Quarterly, Oct. 1940
N.W. Coast Indian Art, R. B. Inverarity, Washington State Musiem Heraldic scenes of the Tlingit, E. L. Keithahn, Alaskan Sportsman Vol. XXVIII
The Haida Indians of Queen Charlotte's Islands, James G. Swan, Smithsonian Contributions to Knowledge, Vol. XVI, 1874.
War Helmets and Clan Hats of the Tlingit Indians, Louis Shotridge, Musiem Journal, University of Pennsylvania, Vol. XX.
Monuments in Cedar, 1963, Superior Press.
The Coast Indians of Southern Alaska and Northern British Columbia, Albert P. Niblack, Report of the United States National Museum, 1888.
Tsimshian Sculpture, the Tsimshian: Their Arts and Music, Paul Wingert, Wingert, Vol XVIII, Publications of the American Ethnological Society. University of Washington Press.
"The Bark Canoes and Skin Boats of North America" by, Adney and Chapell, U. S. National Musiem Bulletin No. 230, 242 pages, \$3.25, 1964, U. S. Government Printing Office, Washington, D.C. 20402.
"Frontier Living" by Edwin Tunis, 166 pages, 1961, The World Publishing Co., 2231 West 110th St., Cleveland 2, Ohio. In Canada, Nelson, Foster & Scott, Ltd.
"Colonial Living" by Edwin Tunis.
"Kayaks to the Arctic" by E. B. Nickerson, 1967, Howell-North Books, Berkeley, California, 197 pages.

I remain Cordially,
Kieth D. Gilbert
Tamal, California

Canadian Tax Land for Sale

H. M. Dignam Corp., Ltd. sends out a brochure every 6-8 weeks listing parcels of tax land for sale through the company. Lists parcels in all provinces and includes a brief but accurate description of each along with its location. Prices range from \$200. to several Thousand depending on Locale, size, etc.

Tracy S. McCallum
Minneapolis, Minn.

\$1.00 brings four issues of brochure from

H. M. Dignam Corp., Ltd.
85 Bloor Street, East
Toronto 5, Ontario, Canada



Land Info on Alaska

Bureau of Land Management
Department of the Interior
Fairbanks Land Office
2nd Avenue
Fairbanks, Alaska 99701

State of Alaska
Dept. of Lands & Minerals
Fairbanks Land Office
State Office Building
Barnette & Sixth
Fairbanks, Alaska 99701

State of Alaska
Dept. of Lands & Minerals
Juneau, Alaska

Bureau of Land Management
Department of the Interior
Anchorage Land Office

MAPS:
U. S. Geological Survey
Fairbanks Office
1st Avenue
Fairbanks, Alaska 99701

Merritt Helfferich
College, Alaska

Agricultural Info

New Canadian immigrants who are setting up farms or looking for suitable sites should acquaint themselves with the publications of the various Departments of Agriculture. In addition to the Canada Dept. of Agric. each province has a department of its own. Most publications are free. The quality however, is subject to great variability. Some are excellent, some are disappointing. (For example "Ontario Vegetable Production Recommendations 1969" contains an excellent and complete variety of information covering all aspects of raising each individual vegetable, while "Ontario Fruit Production Recommendations 1969" is concerned solely with the use of insecticides.) The subjects covered range from very general ("Farming in Canada") to very specific ("Control of the Purple Backed Cabbage Worm in Newfoundland").

The Canada Department of Agriculture will send copies of up to ten publications free to individuals. The List of Publications is available from: Information Division, Can. Dept. Ag., Ottawa. They also offer for sale at \$2 each a great series of soil surveys—very useful to anyone considering buying land for farming.

Each province has its own Department of Agriculture. In Ontario the provincial dept. will send up to ten free publications to each adult resident who requests. The list of publications is available from: Information Division, Ontario Dept. Ag. and Food, Parliament Buildings, Toronto.

In isolated areas cultured dairy products such as yogurt, cottage cheese and sour cream are unavailable at the shops. However these can easily be prepared at home. Recipes, information and bacteria cultures are available from: International Yogurt Co., 8478 Melrose Place, Los Angeles 46, California, or, in Canada, Institut Rosell de Bacteriologie Laitiere Inc., 507, Rue Fortune, Montréal 22, P.Q. In areas where the fresh product is available the product itself can be used as a starter (as, of course, it contains the required strain of bacteria.) With reasonable care to preserve sterility one culture will last a long time.

Does anyone know a satisfactory method for growing bread yeast? This turns out to be the most expensive ingredient in making bread.

Mr. and Mrs. Peter Ruppell
Hearst, Ontario

SELECTIONS: Canada Department of Agriculture publications	
1296	Farming in Canada. 60 pp. Illus. 1966
1224	Climate of the Upper Peace River region. 20 pp. Illus.
868	Manures and compost. 16 pp. 1962
---	Catalogue of Plans: Sheep housing and equipment. 28 pp. Illus. 1965
1019	Sunflower Seed production. 24 pp. Illus. 1967
849	Plums for cold areas of Eastern Canada. 16 pp. Illus.
1217	Culture of cigarette burley tobacco. 8 pp. Illus. 1964
1205	How to grow mushrooms. 16 pp. Illus. 1965
1127	Swine Breeding. 36 pp. Illus. 1962
1023	The dairy goat. 16 pp. Illus. 1957
861	Mushroom collecting for beginners. 32 pp. Illus. 1958
1192	Gardening in the Yukon. 32 pp. Illus. 1963
1322	Booklice. 1 pp. 1967
1362	How to grade furs. 96 pp. Illus. 1968

ONTARIO Department of Agriculture and Food	
128	Beekeeping in Northern Ontario
487	The Grape in Ontario
502	Table Turnips
94	Cultured Dairy Products
193	Tractor Transmission Systems
476	Farm Water Supply
321	Wine Making in Small Quantities
283	White Grubs
226	2,4-D Can Damage Crops
	Monthly Seasonal Fruit and Vegetable Report



Crown lands

The Acquisition of Crown Lands in British Columbia (Land Series Bulletin No. 11) is the official word on procedure, regulations and the access to further information on obtaining government lands in B.C. (I'd guess that the other provinces publish similar bulletins.) Get it free from the Government Printing Bureau, Victoria, B.C. Comes with 2 maps of B.C. (back to back): No. 1—Land Recording Districts and a list of Land Series Bulletins Nos 1-10 (each is reputed to give info on physical features and economy of subdivisions of the province.) No. 2—Index to Provincial Land Status Maps.—each divides available from non-available lands in a small area of B.C.

The procedures for obtaining gov't land in B.C. sound arduous and in all cases except outright purchase, access is limited to British subjects or immigrants. Nonetheless, far more cheap land appears to be available in Canada than in the States. We'll be checking these rumors, gathering information and looking for land this year. We'll keep you informed.

Bill Dickinson
Marysville, WN

Climate info

The most convenient source of accurate information on the climate & weathre for Canada is a small series of mimeographed sheets, two for each and every province, entitled "Precipitation Normals for British Columbia" (or wherever) and "Temperature Normals of British Columbia" (or, again wherever) The cost is a mere 10¢ per sheet.

Unfortunately, the temperature sheets give only the monthly and annual normals of mean daily maximum, mean daily minimum, and mean daily temperatures. No map is included either, nor even the stations' latitude & longitude. But all this information, plus a mountain more is given for much of the country in two sizable booklets called *The Climate of Central Canada* and *The Climate of British Columbia and the Yukon Territory*. The cost of these nice booklets is \$1.30 each.

All the above publications are now obtainable, remittance with order, from the director, Meteorological Branch, Department of Public Transport, 315 Bloor Street West, Toronto 5, Ontario Canada.

The above is a reprint from page 21 *The Complete Walker* by Colin Fletcher.

Thanks
Uncle Tom Rosen
L.A., CA

Other People's Mail

From almost-editor of Nomadics section

I write to tell you, very sadly for me at any rate, that I won't be able to work on the Catalog as we had planned.

The reasons for this are very puzzling to me, and to everyone with whom I've discussed the matter. From the very beginning, all I've written for the Catalog have been honest attempts at correct evaluations of products and services, and the passing along of as much useful information as I have relative to the Catalog's areas of interest. The fact that I work for the Ski Hut presented certain problems, as you yourself said somewhere, so that for a while you were hesitant to mention the Hut at all in the Catalog. But, as you further said, my own statements plus those of other people who were writing to you, indicated that the Hut was indeed worthy of inclusion. This made me happy for two reasons: first, because I do work for the Hut and so am interested in its welfare and believe that the Whole Earth Catalog reaches a very important market for the sort of gear we sell, a market which I don't think we get to in any other of our advertising. Second, because I do believe that the Hut sells good stuff, and that people should be aware of it when they're in the market for quality equipment. Also, in the same vein, I recognize the quandry of the mail order buyer with a handful of catalog, trying to distinguish between superlatives, and was in hopes that the Ski Hut could offer a service beyond the ritual processing of orders and cashing of checks.

When you asked me to edit the nomadics section of the catalog, I was happy at the thought of being able to correlate a lot of material relative to the camping and mountaineering merchandise market and presenting a kind of unsavory buyers' guide, particularly slanted to those people who know nothing about what's available or how good it is, and are hesitating about getting their feet wet to the tune of several hundred dollars. On the other hand, I realized that in editing that section, I would be able to present the Hut in the most favorable honest light possible, concentrating on the many items we make and sell which are really tops in the field.

As I told you, the number of catalog requests we've received at the Hut which mention the Whole Earth Catalog have been so phenomenal that they've actually made me wonder whether the thousands of dollars we put out for conventional advertising are really well spent. As a stated part of my job is market research and opening up new ways to get the Ski Hut across to the potential mail order market, I felt that I was performing my job in a particularly unique way. Additionally, I felt that the favorable image of the manager of the Ski Hut Mail Order Department acting as editor of a section of the Whole Earth Catalog, and giving credit where it is due to the Ski Hut's competitors, was an even more valuable piece of publicity, and an assurance that Ski Hut mail order customers will be afforded fair and honest treatment, on as personal a level as is needed, which is the truth.

Sadly, however, the management of the Ski Hut does not see things my way. I am sorely tempted toward an orgy of name-calling and vituperation, but will try not to indulge myself. From the outset of my association with the Whole Earth Catalog, my employers have not been happy with what went on, and have tried their best to search out areas to complain about: Are you doing this on Ski Hut time? Are you revealing to the Whole Earth Catalog our sources of supply? Are we losing sales because of items we sell that the W.E. Catalog sells, too? Are you making a lot of unauthorized discounts to people who write in because of the W.E. catalog. What's it costing us? Etc, Etc. Each time these things were levelled at me, I tried as best I could to allay their fears and to assure them that the Ski Hut's inclusion in the Catalog was all on the credit side, and was the cheapest form of advertising that anyone ever heard of. As each issue of the Catalog or the Supplement came out, I made it a point to bring it to their attention, pointing out all the nice mentions that were in it. To my continuing surprise, they remained unimpressed and suspicious.

Finally, however, they have been able to find something that falls definitely within their canon of transgression. I have actually had the temerity to say something good about our competitors! This, they feel, is "unbusiness-like" despite the possible truth of what is said. I'm sure this is correct, and it's why I'm as enthusiastic as I am about the W.E. Catalog's importance in helping to change the way business is presently done. However, they have indicated that my continuing participation in the Catalog will be regarded unfavorably by them, and so on and so forth.

So, sad to say, you see yet another poor chap ground in the machinery of commerce. Given my responsibility to my family and my continuing reliance on the various monetarily-gained product of the world, I feel acutely the importance of steady, reasonably well-paid employment, as I told you a long time ago. So, if you watch closely, you will observe the spectacle of fearless Roland frantically copping out. Sell out! Sell out! they scream, as I snarl, say "Lemme alone, ya bastards!" and sidle off hyena fashion.

I do now officially repudiate all the good I've said about the Ski Hut's competitors. They are all vile trash, attempting to make a silk sleeping bag out of a sow's ear. Don't buy none of their junk, gang, the Hut's where it's at. I musta been drunk when I said those other things, or all doped up. Shows you what happens when you hang out with hippie catalog makers. And back I go under the wing of the great powers of Backpack land. However, as Galileo once said, *Eppur, si muove.*

I will of course continue to contribute pieces when you want them, perhaps under various *nom de plumes*: Raskolnikov, etc. And Ski Hut mail order customers can still depend on me to be as helpful as I can and responsive to their needs. And, of course, everything is always changing, right?

Love,
Roland Jacopetti.

P.S. Know of any good high-paying near-to-Marin County gigs?

P.P.S. Roland has since left the Hut and is directing a movie with Ben Van Meter and the Congress of Wonders, may they never cease.



What is responsibility?

We asked for a review copy of a Midwifery book.

Your undated inquiry got here on December 15. Before the inquiry got to my desk, the content of the inquiry initiated a good bit of buzzing among the personnel. In any event, I am happy to answer.

We are a publisher and not a distributor (if by distributor you mean a wholesaler who serves as an agency for publishers). Although we are in a position to supply a review copy for your catalog, I hesitate to do so because of the many ramifications. Although one would expect the birth process to be as natural as is any other body expulsions, the occasional birth is accompanied by complications. I am familiar with your catalog and thereby hangs my reservations. You risk little when you encourage your readers to build their own houses, but you risk death when you encourage them to attend to their own pregnancies and deliveries. Or do I miss the intent of the inclusion of a book on midwifery?

Yours sincerely,

Dick M. Hoover
Vice President and Editor-in-Chief
William & Wilkins Company
Baltimore, Md.

DMH/dw

Dear Mr. Hoover,

It's not a question of whether we are encouraging non-professional home deliveries—they are occurring in large and increasing numbers anyway. The question is whether we encourage the use of good information in conducting those deliveries, (such as full knowledge of the risks). We do encourage this. Will you?

Whole Earth Catalog

From Moe Armstrong

this is my third year in new mexico, the second year just living in national forest, in wickiups, this year its more like a lodge 35 feet long, 6 feet high. the ranger loves us, (we keep a "Model camp") and we got a jeep truck.

Moe Armstrong
Vallecitos, N.M.

the river
running south
running brown
running south
sun setting
on
brown mesas
turning
clouds
golden
(rays like lances)
the valley
the river
the sun
the clouds

all turn
into
a feather
and
drift
towards me
waiting
for
the truck ride
to end
waiting
for
the hiway
to go
somewhere
else
and me
to live
another
way
and
find
something else
to do
(with what i got)

snow fell
clouds
storm came
went
walking.
met
jim
saw
the meadow
returned
to
chop wood,
drink tea,
getting
warm
and dry

Sorry

I'm W.E.C. subscriber and I am now more frenzied than I was before and it was bad before.

Clark Natwick
Pacifica, CA

Evolution

Gentlemen,

I have to comment first on an inclusion in the catalog, *Process and Pattern in Evolution* by T. Hamilton. This is perhaps the single worst book on evolution currently in print. The style, such as it is, is a travesty of academic prose. The contents, such as they are, misplace emphasis, create fictional categories, convolute real ones and generally miss the whole point. You do your readers a disservice. *The Life Picture Book of Evolution* would be better: at least the illustrations mean something.

Also, *Design for a Brain* is pretentious, nothing more. The book you want is *Machinery of the Brain*. It is a nontechnical exposition by a man who appreciates the ultimate subtlety of his subject matter.

Access to tools in the natural sciences: Study Nature, not books.

Almost all science books are worthless from this viewpoint. One is interested only in books which advance ideas. Interpretation, synthesis, particularization, instantiation, verification, extension and application are what it means to conduct ones own education. These things are done, not read about.

There is, for example, only one book about evolution: *The Origin of Species*. Its all there. You can make of it what you wish, or read what somebody else* made of it if you really care. There is no book about ecology. Ecology is a synthesis and extension of two fundamental idea nets, evolution and genetics**. There is no book about the brain, because the brain is the unsolved problem of man. There are however background books on the brain which should be available: *Conditioned Reflexes* by Pavlov, *The Study of Instinct* by Nico Tinbergen, *The Computer and the Brain* by von Neumann.

The problem with getting on top of technology is separating knowledge from fact. One should avoid imprinting his brain with too much data before he is prepared to process it. Processing works both ways.

Chris Smith
Eugene, Ore.

*Not T. Hamilton.

**J.D. Watson's *Molecular Biology of the Gene*, for want of anything better.

Reply:

Thanks for much-needed criticism, most of which I share. I've looked and looked for something decent in evolution (Darwin wrote a needlessly heavy book to overwhelm criticism—needless now anyway—and a lot has happened since Darwin, such as genetics.) For introduction, Hardin's "Nature and Man's Fate" is looking good. I haven't seen the Life book; should I? DeBeer and Ehrlich have hobby horses they ride too much (Ehrlich's an old teacher of mine). What do you recommend? I study evolution in my own head, which gives a handy time scale but monumental Heisenberg obstacles.

What is instantiation?

Stewart Brand

Reply:

I have collected the following suggestions: The best general book on evolution: Verne Grant, *The Origin of Adaptations*. An alternative to Hardin, for light reading: Huxley, *Evolution in Action* (paperback). Three difficult but very good, advanced books:

Simpson, *The Major Features of Evolution*
Rensch, *Evolution Above the Species Level*
Mayr, *Animal Species and Evolution*.

I learned about evolution in a textbook of general biology, *Life*. The evolution parts are due to Simpson and are some kind of classic, the best part of the book and perhaps the best available introduction. I have not read any of the five books suggested above.

The problem of hobby horses seems to be quite general. There are two main classes of evolution books, anthropology books and biology books; biology books may be written by zoologists or by botanists and differ accordingly. There are also various heretical books which would deserve notice if they were less polemical. Apparently there is nothing to do but read a lot.

I have only looked at the pictures in the Life book, but they are enough. The whole Life Nature Library is easily as good as the Science library, for the same reasons. The set costs something like \$90. Someday I am going to buy it.

A paragraph in defense of the great book theory of education... The theory obviously applies sparingly, if at all, there being just too much information to assimilate in any way, least of all an inefficient way. However, the advantages of reading ideas in their original, developing forms are considerable. If the idea is complex, the original form may tentatively suggest a line of thought that would be suppressed in subsequent, well-formed texts. If the idea is simple, the original form may be brilliant. Evolution is a simple idea. It is easy to state. So is the four color map problem. The unusual power of such statements is displayed only by example. Evolution deals specifically with the most incredibly complex structure ever conceived, not by simplification, models, approximations or limits, but directly. As theories in science go, this is a lot. The best way to see it is to read a book like *Origin of Species* which (with a style in the great tradition of heavy-handed 19th century scholarship—a nice change from obscure modern writing) gives a feeling for the depth and range of explanation allowed by the theory. It is of course true that Darwin did not know about genetics, but genetics takes books just to write down. Furthermore, there are no great books in genetics. The object of study was not even defined until 1953, and early research understandably tends to be confused or superfluous. This is certainly more typical of science, and it serves to emphasize the importance of the few great books that do exist.

"Instantiation" was supposed to be "instantiation." I was listening to Abbey Road, if that helps.

Chris Smith

What is instantiation?

Sell Snuglis

Should any of you satisfied Snugli Mothers care to spread the Snugli word in your areas, drop us a card. We'll send free Snugli brochures and details on handling Snugli commissions at \$5 for each sale. No complicated process involved.

SNUGLI
Route 1, Box 685
Evergreen, Colorado, 80439
Tel: 303-277-0131

Alternative child styles

There are unfortunately so many things to do in the process of finding alternative lifestyles that there isn't time to list them, let alone do them, and I hesitate to add to the list. However, there's one very real problem I haven't seen mentioned, and that I think most certainly ought to be, and that's the difficulty of finding any sort of literature for our kids that doesn't constitute total propaganda for the establishment set. Particularly for those of us who are in the untrustworthy over-thirty group, have kids, and for one reason or another cannot drop out totally at this point, there is a terrific need for something in the way of reading materials that the kids can enjoy that isn't completely based on the S.A.L. (Standard American Lifestyle.) There is so little you can give them that doesn't involve the Papa X, the Mama X, and the Wee Little Baby X, in their Own Little House, with the Own Little Beds and their Own Little Chairs, and so on ad infinitum. Every media they're exposed to gives them the impression that no other arrangement is even possible for human beings, and there are too many ages for which *The Harrad Experiment/Stranger in a Strange Land* and so on is just not very interesting, even if they can read it. Breaking down the dependence on the holy Family, breaking down the Romeo-Juliet Myth, all of that, is a fulltime job for us guerilla families, because we live surrounded by it. (Sure, getting the kids out of it is the best way, but in the meantime the problems remain very real ones.)

It seems to me that two steps need to be taken. One, we could use a list of already available materials. Folktales from cultures which do have alternative lifestyles, for instance. Fantasy that kids can handle, little ones as well as big ones. Somebody ought to do some research and find out what already exists (and I'm sending a copy of this letter to the people at *WHOLE EARTH/PORTOLA*, since they are perhaps best equipped.) Suggestion Two, some of our people ought to write some things that would be of use to compete with the S.A.L. literature. I'm not suggesting that we do *The Bobsey Twins at Morningstar*, although at this point I'd almost welcome that—but we should be able to do some good things.

I know there's lots of other stuff around, music, games, just observing those of us who are fortunate enough to live in The Country of the Loving Mind, talk, dance, on and on. But we really do need reading material for our kids—mine are the omnivorous, devour two books a day kind, and I am continually fighting the hangups the available children's literature gives them. Maybe I'm just ignorant of what really exists? If so, I'd appreciate being educated.

Love,

Suzette Haden Elgin
San Diego, Calif.

Congratulations

Thank for the new catalogue. But what I did on 12 December was to deliver my 1st child at home absolutely unassisted. Not the recommended method but (good for me) fortunately successful. ♂ → Noah Sky Kelsey Lundy ♀ I will review Needham as soon as I've finished reading it but I'm missing a volume or 2 or 6 Did you see Soleri photos in last week's *Life* (with antelopes on the cover)?

Claire Weintraub
New York, NY

Hot Scandal

Want to call your attention to one thing: Jeff Schlanger's review of Paul Soldner's kick wheel—p.54, spring 69. Being a professional potter of some ten years—I really take exception to it. And I'll tell Jeff next time I see him. Paul Soldner's a nice guy & good potter and his wheel is OK. But the key to the statement that he "produces the best potter's kickwheel" is kickwheel. *It isn't the best non-power wheel nor the least expensive* by any means. And Schlanger knows better—it isn't his 1st choice either. What,—did he get a free wheel out of Soldner for writing that review.

The best non-power wheel made in this country is a treadle wheel made by H. B. Klopfenstein & Sons, Rt. 2, Crestline, Ohio.

Schlanger has one, and swears by it, (privately anyway) as does every potter I've ever known who knew about or owned one. They sell for \$175.—f.o.b. Crestline, Ohio.

The thing is few people know about them.—They have no publicity and even if you write for info they just send you a little sheet of paper that wouldn't sell anybody on them unless they already knew how great they are.

People who have them call them the "Rolls Royce of manual wheels" they have lots of advantages over Soldner's kick wheel—much more sensitive, smooth, and more versatile. You can throw larger on them cause you can get on top of the clay—since you're not captivated in a seat. Besides which they cost less.

They have been making them for years and they are just as precision made with the same expert craftsmanship today as they were ten years ago. I know. I bought one just a month ago.

I have a friend who got one 7 yrs ago — she throws on it 6 hrs/day every day. — never oils it or cleans it — gave it one paint job in all that time — it still works beautifully — she can throw fifty lbs. of clay on it and it will take it without a waver. — It's a real beauty and so few people know about it — a damn shame — cause the wheel you work on — makes all the difference.

Be Gentle

One suggestion on the catalog.

You might mention that it is best if people only send for info on items they might really want, since hundreds of curious people who don't buy can quickly raise to an unbearable level the publicity & catalog cost of the smaller artisans & companies we like so much.

Edward N. Robinson
New York, N.Y.

From Vietnam to S.F. Chronicle

Editor—The Army is throwing an unfortunate man, Lieutenant Calley, to the lions den of the most politically immature population of the modern world.

We are foot soldiers, and know the type of war this man was engaged in. In war there are no rules, and in this war only one thing has any meaning, and that is to stay alive.

Charlie comes in both sexes and various age groups, from the old man who keeps a daily count of a convoy, the woman who is a member of a female mortar squad, the babysan who attempts to steal a few rounds of your ammo while you are giving candy to his little friends, to the teen-ager who fires the Russian Ak.

There's no such thing as a non-combatant in this war. If you move into a village complex and are ambushed, or lose men to booby-traps, as retaliation for a first encounter you may just burn down the offending houses. To lose friends in a second or third ambush, or to encounter more boobytraps in an area you've just recently cleared requires a more forceful and lasting counter action.

You know that this is a VC village, they are the enemy, they are part of the enemy's war apparatus. Our job is to destroy the enemy, so kill them; a war can be won only when the enemy forces are destroyed or too demoralized to fight effectively. In my estimation they are all soldiers, old or young, male or female. They all can contribute to the death of an American soldier. Only when they can no longer harm my friends or myself are they noncombatants.

Why must Americans be so childish, this is not a game. Rules of kindness and nobility do not belong here. No other nation in the world would fight a war with the enormous restraints and restrictions that we foolishly place on our military. It's ridiculous to expect us to be the nice applepie and mom-loving GI's that are our nation's myth.

The VC murder people who refuse to cooperate with them; I know because I've seen the bodies.

I want to come home alive, if I must kill old men, women, or children to make myself a little safer, I'll do it without hesitation.

War is ugly. There are no rules of good conduct toward the enemy. Lieutenant Calley was trying to keep himself and his men alive, in doing so he killed some of the enemy. This man should not be tried for what thousands (on both sides) are doing now, millions have done in the past and will do in the future.

I'd be willing to bet that the next time American units went into that village they'd encounter very little opposition. To my mind his was a successful, and anything but unique, type of operation.

It's unfortunate that the American Army, Government, and people do not have the intelligence to see it as it is, accept it, and support the men whose lives are on the line, who are dying and being mutilated by a murderous, efficient and brutal enemy that can be defeated only if we are as inhumane as he. Grow up Americans. Are we to be condemned to a philosophy of idealism and good guyism until we bring about our demise by falling to a goal-oriented enemy who sees things realistically and who lets nothing stand in his way?

Sgt. Raymond Hicks,
SSG Bobby L. Stengill,
PFC. Carl W. Jackson,
SP-4 Daniel L. Niessen,
Sgt. Frank R. Nilsson,
25th Infantry Division.
APO San Francisco.

coyote call
on a dark nite

down
the
canyon

(holding
the dark
in
the shape
of trees)

first
one,
then
two,
then
several

coyote calls

smoke
circling
inside
the roof
trying
to get out
the
smokehole

but
just
coming
down

lower
eye level

finally
the fire
burning

bright

snow
coming
off the trees

in
big bunches

filling
the air
with
white powder

all
yawns

fired up,
letting
snow melt
off
the wickiup



ON THE SUBJECT OF WHEELS—

TH SHIMPO—Japanese made is one of the best power wheels—beautiful design, good except for very large amounts of clay—price fluctuates but it sells most places for around \$300,—but unlike the Klopfenstein it is getting adequate publicity.

Anyway, thought you should know about the Klopfenstein—I've never heard of anyone being unhappy with one—which is something I can't say about Soldner's kickwheel.

Mary Ann Gehan
South Ackworth, N.H.

OPTIONAL EQUIPMENT

- reversible throwing head for making plaster bats with a special band and locating slug for re-centering \$15.00
- adjustable hip rest \$15.00
- shipping weight approx 240 lbs.
- price \$175.00 f.o.b. crestline, ohio

h. b. klopfenstein & sons route two crestline, ohio 44827

Why people here fight over who gets to open the mail

Dear Whoeveropens this letter,

Please send me a copy of your creation entitled "The Whole Earth Catalog"

Please send whichever 69 catalog that is in season. If I like it, I may buy the other. Isn't that nice. Good-bye.

George

P.S. Below is a picture of my house in case you lose my address, you can still send it.

Sorry, I changed my ever-lovin stoned mind. Please subscribe me. But be gentle, this is the first time I have ever been subscribed to. I have always wanted to and have wondered what it is like. My parents told me that subscription was evil. But others have told me that it is beautiful. I hope so. Mummy & Daddy said I should save my subscription for whoever I intend to marry.

But can't I subscribe in a meaningful relationship without being "legally" married?

Please stop laughing, this is my first subscription and I want to be sure of what I am doing.

After all, I don't want you to lose your respect for me. I hardly know you, but here I am subscribing to you.

Please!!

You will be carefull
Won't you?



From Steve Baer

Things are going well here. Day is leaving for a month in N.Y. and Boston hitching to the East Coast. He finished one version of a sun tracker. It is powered by water pressure—a few gallons of tap water a day—and controlled by an automobile radiator thermostat. It is nice. Beautiful and very sensitive. The design using feedback has this funky radiator thermostat performing a most delicate flow control. We thought the whole system would wobble from side to side—"hunting" they call it but no it tuned in perfectly. The clumsy apparatus performing was beyond expectations—very exciting and encouraging. I look at it with the shadow line in the perfect place—and I think of an elephant writing on the back of a postcard.

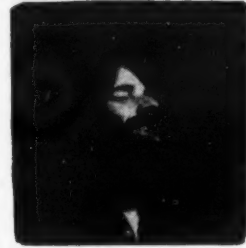

Steve Corrales, N.M.

How to Dig a Dome

Our first dome is almost completed. Name Rana Grande from the arched windows that were thought to look like frog eyes. Tomorrow we finish off the first third of the pur and then decorate the dirt dome. Wednesday we expect to carve the mound. Weds afternoon to the vigil. Thursday we finish Rana Grande & let it cure for the grand excavation & dedication Saturday.

The dome of Rana Grande is 12 ft in diameter & 9ft high. It is more or less a hemishere with the front sliced off. (Dont worry about the spelling. I know how to spell but this typewriter doesn't & I dont give a damn.) It is a mound of earth upon which we are puring a 6 to 4 inch shell of cement. Saturday we will excavate the dirt mound and reveal the completed room. It has a fireplace poured at the same time.

This dome method should have real applicability to the alternative community because it is cheap, artistic, organic, romantic, practical. This one is taking fifteen sacks sement @ 1.50, 10 tons concrete mix @\$2, & 15\$ worth of reinforcing bars, screen door (from the dump, and window \$5. Total about \$65.

Another advantage is that there are no skills needed. See one and build one. Simple. You dont even have to be artistic. Tools needed are shovel, wire pleirs (for wiring reinforcing bar together), Concrete mixer not, strictly, required. Do it (mixing) in a box. So the other tool you'd need would be a concrete mixer or hoe with mixing box.

Our domes are built into the side of a hill. Much of the structure will be below grade level when finished. Some of excavated dirt to be used to form a terrace in front.

See diagrams for more explanation.

Good luck & thanks for going to the trouble of putting out such an interesting catalogue.
Virgil Byxbe
Sweets Mill, CA

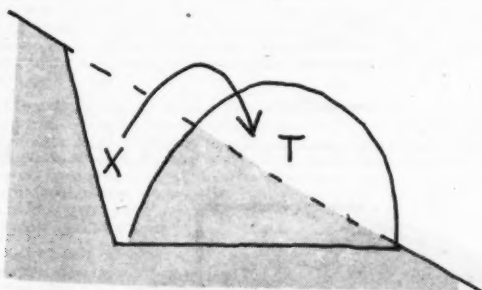

Dirt from X(cavation) is thrown on top of hill to finish off dome. The mound is formed partly by excavating a ditch away from a central circle & partly by thowing the excavated material on top.

Canal boats

If the freeways ever pave their way over domes & tipis there is an outlet

Canal boats 80' long are available here for \$800-3000 livable as is or conversions with no building codes etc. Our tie-up fee in the city of Amsterdam is \$6/a month. It's a common independent life for many of the most interesting people in a rather free metropolis.

My wife asks if it is possible to print future issues of the CATALOG on vinyl so I needn't replace it with our food budget, or perhaps include listings of printed salt crackers or otherwise edible books.

Best regards
and good luck in
your fantasies
Dan & Sue Brown
Amsterdam-Zuid, Holland

Yikes

Sir,
Whole Earth Catalog, Fall 1969, (How to save the World) would lead people to believe it is easy to adopt a baby. Nothing could be further from the truth!

Since 1960 California has consumated over 50,000 adoption. (Most of these children were illegally ripped-off un-wed mothers.) Calif. now has some 20,000 children free for adoption. "Enough people to adopt cannot be found" so the story goes. A) If these babies were not ripped-off in the first place the problem would not exist. B) If all the couples who have already been qualified to adopt, tried, they would be denied any attempt to adopt the existing 20,000 babies.

You rightfully state couples should adopt existing babies, rather than bring new babies into an overcrowded world. But to go to an agency for that reason a couple would be denied. "Altruism to adopt is suspect."

You rightfully state the adoption picture has changed. But that's all, only the picture! Nothing else. A couple must still prove sterility. It is still just as impossible to adopt today.

Over 50% of all adoptions in the state were on the Grey Market without benefit of a Social Worker. There is no evidence to show these adoptions turn out any different than agency placements. (so.) it would follow that the social workers inability to exercise her selectivity is no loss after all.

We place babies simply by sending the un-wed mother to be into hospital in the prospective adoptive parents name and the baby is born to them. Its legal.

Unless you recind your attitude, you are part of the problem.

Respectfully,
Dr. T.R. Calaman
3340-A 22d Street
San Francisco, CA 94110

For warmer baby-having

I had my first baby 3 1/2 months ago in a hospital in S.F. which was supposed to be the best around. [French Hosp.] The delivery was beautiful, but the next 24 hours were some of the most unhappy in my life. 45 minutes after he was born, they took him away from me and I was allowed to see and touch him only twice in the next 24 hours for a total of about 1 1/2 hours. Fortunately I left after only 24 hours. The point of all this is—I know it is as bad or worse for every woman in this country who does not have her baby at home—and there are very few doctors willing to deliver at home. I think ultimately the only solution is more home deliveries and/or maternity homes that are warm, understanding and human. I would like to hear from others who feel the same way and either:

- 1) know of doctors or midwives anywhere in the US,
- or 2) know of or have ideas for good maternity homes with rooming-in 24 hours a day, starting immediately at birth.

I would be happy to supply any information I get to anyone else who writes me and wants to know—but please send me a stamped, self-addressed envelope.

Also, you should list *Common Edible & Useful Plants of the West* by Muriel Sweet. Obtainable from Naturegraph Press, Healdsburg, Calif. About \$1.00. I know it does not cover the whole country, but all the books you list (Euell Gibbons, etc.) are really not much use in the West. Other helpful Western books are *Early Uses of California Plants*, by Edward K. Balls, \$1.75 from Univ. of Calif. Press, Berkeley. *Guide to Common Edible Plants of British Columbia*, by Adam Szczawinski & George A. Hardy, Handbook No. 20, available from the British Columbia Provincial Museum, Dept. of Recreation & Conservation, Victoria B.C. about 50¢. This letter has 76 pages of illustrated plants, and is valuable, not only in BC, but to a varying degree (less as you go southward) along all the U.S. Pacific coast. Two other excellent books for Westerners are *California Spring Wildflowers* and *California Mountain Wildflowers*, by Philip Munz—well illustrated & non-technical. I have found that in using herbs, you have to read as many as you can find and extract the useful parts from each one. There is no one good, reliable all-purpose herbal & plant identification book that I know of. If an herb is listed in one book as having a certain property, don't believe it until you find it corroborated in another book. Often one will list many uses for an herb, while another will warn you that it is poisonous and not to use it. It's hard to know who to believe. Also, medieval cookbooks & herbals are fun and sometimes useful. Likewise household encyclopedias and how-to-do-everything-under-the-sun books from the nineteenth century.

Roxane Friedman
824 Pelton Avenue
Santa Cruz, CA 95060

Name your poison

Your WHOLE EARTH CATALOG and Supplements have just come to my attention. What an exciting, worthwhile venture. I was so pleased to see the Pyramid paperback edition of my *The Natural Foods Cookbook* included, as well as other items and groups well known to me. May I suggest a few more for your consideration?

—Enclosed is a mimeographed statement describing the Federation of Homemakers, a group devoted to keeping food safe and pure, without additives or pesticide residues. It deserves support, and welcomes membership from all who wish to help with letterwriting. Although it is primarily a group of women, men are also welcome. We are not female chauvinists! [Federation of Homemakers, 927 North Stuart Street, Arlington, Va. 22203

—Enclosed is a fier on another of my books, *Gardening Without Poison* (Houghton Mifflin 1964). In view of the growing concern over the persistent pesticides, I have attempted to outline the sane, safe and effective alternatives. This is a book not only useful to gardeners, but of interest to all consumers. [\$5 from Houghton Mifflin Co., Wayside Road, Burlington, Mass. 01803.]

—Please publicize a dandy little 8 page mimeographed pamphlet, *If You are Pregnant and Want your Child*, made available from the Student Research Facility, 2214 Grove St., Berkeley, Cal. 94704 (no price, but surely a modest contribution would be appreciated so that the pamphlet can be distributed to those who need it). It was written by Thomas Brewer, M.D., a socially conscious California physician who has worked with low income pregnant women in a prenatal clinic to teach them the importance of nutrition.

—You have publicized *Consumer Reports*, the magazine of Consumers Union, Mount Vernon, New York, which does a commendable job on many consumer goods, but is horribly poor on the subject of food and nutrition. (It assumes that whatever the government sanctions must be safe. ha, ha.) Please, please publicize *Consumer Bulletin*, official publication of Consumers' Research Inc, Washington, New Jersey 07882. It is the oldest pioneering consumer research organization in USA, and has been testing and reporting on products since 1927. It is consumer-supported, non-profit, and is not supported by any manufacturers, dealers or government agencies. For this reason it is completely independent, reliable and unbiased. Throughout its history it has had an excellent record of information on foods, nutrition, the dangers of additives, pesticides, the inadequacies of FDA protection, etc; Mr. F. J. Schink, its president and technical director, will be remembered as co-author of *A Hundred Million Guinea Pigs* and author of *Eat, Drink & Be Wary*, etc; \$8 per year for twelve issues (Canada & foreign \$9); the Annual, \$2.95 (Canada & foreign \$3.25)

Beatrice Trum Hunter
Hillsboro, N. H.

Stock Answer No. 1, in depth

Hey Hello Whole Earth Catalogue,

I saw in your supplement that you were going to compile a list of people who wanted people for communal families. Hello, hello, add one more for your list!

After thirteen years of wasted education I'm tired of the whole mess, and I've decided to leave it I've decided to fulfill a dream that I've been playing with for a few years. You see, [etc., etc]

After this I would gather together with like minded people to form a cell together (and to the degree that we can) we confront others with our way of life, when they see that our way is better, they will join us. [etc., etc]

Robin

Dear Robin:

Hmmm, well, sounds like you still qualify as an individual, rather than a functioning community, which means you gotta find your own compadres. We're really too remote from you to be any sort of useful avenue—what we had in mind was already-existing communities who want new members—significantly, I feel, we haven't had even one wanting to be so listed. My very own personal, off the record opinion is if you can't find like minds in your own back yard, so to speak, a printed "ad" won't help much. What you need are warm bodies & clear minds, right? If we published your name what you'd get would be weird letters. Anyway, we said we were staying out of it. Good luck—

Sincerely,
Diana Shugart
Whole Earth Catalog

From Zen Mountain Center to Anonymous

Here goes an attempt to explain what we are trying to do: Zen Mountain Center is a religious community based on the teachings of Shunru Suzuki Roshi and thru him, the Buddha, & on the need of finding an alternative way of life to those that have so far been offered to us by the mid-20th Century American tradition. Our way is traditional in that it represents 2500 years of spiritual growth, decay & growth, & is unique & undefined in that the Sangha, the men, women, dogs & cats here, take care of themselves in ways that were not possible for Buddhists in the past. But we are lucky because our leader supplies a center of trust & so there are never any real problems. But I think he would say we were actually unlucky.

Yours,
Peter Schneider
Vice President at
Tassajara Zen Center
Carmel Valley, Calif. 93924

Farmers of 40 Centuries

I ordered one copy—*Farmers of Forty Centuries* by F.H.King, from Hillary House Publishers in New York, only to learn that it is out of print.

If you have any copies in stock kindly send me one. If not, let me know how we can get someone to reprint it, as I have read this book and have found it not only full of practical advice on farming, but a most encouraging source for anyone trying to lead a simple life in harmony with the universe. In fact, I have come across few books that display such a sensitivity to the interrelationship of all as part of one.

Sincerely,
Ken Freidens
Warren, Maine

Hillary House is considering reprinting the book, if they know people are interested. Write to:

Hillary House Publishing Ltd.
303 Park Avenue South
New York, NY 10010

See Wendell Berry's review in Spring 69 Whole Earth Catalog.

—Tinkerbell



From Drop City to anonymous

Drop City has evolved a tradition of which we feel we can be proud, a tradition of taking life easy of surviving efficiently.

A stint in D.C. is an absolute must for potential community dwellers, for the merely curious, for the vaguely interested. Just move in, give someone all your money, eat the food, ignore everyone who tries to kick you out. Eventually someone will have to leave to make room for you.

The experience gained thus is invaluable. In all likelihood you will be acclimated to communal living before you have to leave.

Droppers

From Tom Duckworth

The Nucoa Ranch (the low cost spread — Nu Community Attempt) is alive and well. We've been settled since late August—have a years lease (rent free) starting Jan '70—like I said, we're settled. The campers are off the trucks and the trucks are back to work again—gathering firewood, making a little money, etc.

Am tempted to ramble about our activities (pressed 30 gallons of apple juice and hard jack—the chicks make a farout homemade ketschup, etc) but that must wait for my "Memoirs"

RELATED ITEM
(July Sup) "Buncie Shadden Di Gesu suggests"
DMC Encyclopedia of Needlework

We got a copy (price is up to \$7.50 & .50 handling) Connie and Nancy both love it — got better view of macrame than Macrame book. Good on sewing and other related items — REALLY a good book.

MORE NOTES ON GETTING BY WITHOUT MONEY (see Jan '69 Sup) lumber mills sell slab ends very cheaply—out here they cost \$1.00 for a truck load (1½ ton truck)—ideal for building sheds, gates, fence, room partitions, etc. (Slab ends are miss cut boards, outer slices with bark on one side, knotty planks —) Mill ends (off finished pieces—1-2 ft plank and 2x4) cost between \$1-4 a truck load—good kindling, childrens building-blocks, bookcase supports—We made our apple juice from good apples left behind after the pickers were through—"ground" apples were free—we got about 20-30 bushels.

The Nucoa Ranch Suggests
For good prices on Chain saw sprockets and chains, write to
ZIP PENN INC
P.O. Box 876
Bellingham, Washington 98225

Tom Duckworth
Embudo, N. M.

Brazil

Brazilian land can be purchased at prices starting at 6¢/acre up to two dollars, with legal title and tax exemptions. If any of your readers would be interested in further information they could contact me by mail at the address below and I would be happy to supply what ever information they require.

John F. Thrall
550 Seal Place N.E.
Atlanta, GA 30308

Peace Corps let down

There was this outstanding publication called *Tech Notes*, edited by Lester Goodin, published by the Peace Corps, which carried invaluable information on village technology. The August 69 issue had well-illustrated articles on water wheels, sealed wells, a Chad chain pump, raising rabbits, fertilizer in corn production, a grain dryer, and news on technical manuals.

So we wrote *Peace Corps* to find out what this dandy item would cost in the states and we planned a big space for it in the CATALOG. Confusing letters came back from various people, ending in the one below. We wrote Lester Goodin to find out what was happening and got a tart reply that he was no longer with the Corps and *Tech Notes* was discontinued. Interesting. They opened a letter addressed to him. Turns out they open everybody's mail.

Your request for permission to publicize *Peace Corps* publications has been brought to my attention by Mrs. Nikkel. It is understandable that our manuals and publications could be thought useful by members of the American public, as well could they be in isolated cases. However, these materials are designed specifically for use by our Volunteers in underdeveloped countries. Formulas, techniques, and plans of action are relevant to the degree of technology, available materials and cultural mores of those countries, and as such give these items a small degree of suitability to the United States.

There are numerous agencies which should be able to assist anyone in need of materials equivalent to *Peace Corps* publications. To name only a few: the Department of Agriculture, Department of Health, Education and Welfare, Housing and Urban Development, Forestry Service and the National Education Association. Such agencies can supply a more adequate selection of materials relevant to specific needs.

We appreciate your interest in our materials and your concern to aid the public. We hope that you will understand and ask that you withdraw any ads from your catalog which concern *Peace Corps* publications, especially *TECH NOTES*.

Thank you for your cooperation.

Sincerely,
David A. Miron
Deputy Director
Program Development,
Evaluation and Research
Peace Corps
Washington, DC 20525

FIGURE 5
WATERWHEEL IN PLACE

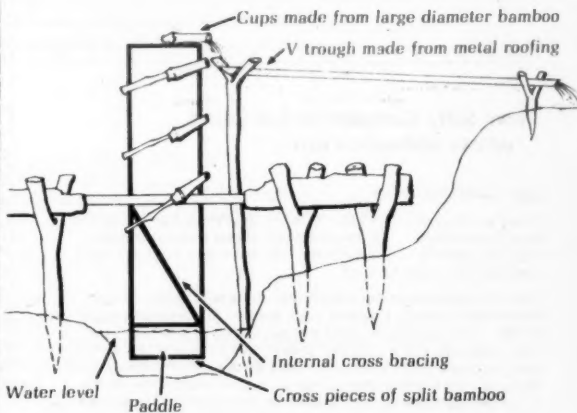

From TECH NOTES

Customer Controlled Quality—a true story

Oct. 21, 1969

Dear Whole Earth:

There is something I wish to bring to your attention concerning my reactions to a recently purchased product, which is listed in the catalog.

This particular product is an Ashley 27C, Thermostatic woodburning heater. I purchased this heater on the basis of the Catalog's evaluation, assuming that the heater was of good quality; as they probably were when you tested them.

Anyway, the heater I received was terrible. The workmanship was about the worst I have ever seen. Specifically, there were numerous casting faults in the heater door and top i.e. the lower hinge on the door had a fault all the way through to the pin hole. This was covered by a small piece of tin which promptly fell off. The heater top had been ground to a ragged and razor-fine edge thus making it very dangerous. The top door was poorly fitted and emitted large amounts of air thereby causing the thermostat to malfunction. The asbestos gasket on one side of the front door fell off after only four fires. Finally, the bottom stand, upon which the heater body mounts, was badly warped from stamping, making it very hard to assemble the heater.

So I don't feel that this heater is worth the \$90. odd dollar cost just for a thermostat and I would appreciate your retesting and evaluating this economy heater as it seems their quality has changed.

Your attention is appreciated.

Peace
T. Coleman
P.O. Box 75
Casper, CA

Mr. Robert Smith
ASHLEY SPARK DISTRIBUTORS
710 N W Fourteenth Avenue
PORTLAND OREGON 97209

24 October 1969

Dear Mr. Smith,

I am enclosing a letter written to us by a catalog reader who ordered a stove on the basis of our listing in the Catalog.

We have sold several stoves as dealers by now, and have never received any complaints. All our customers have been delighted with the Ashley Spark products and one even ordered a second stove.

However, we feel that more can sometimes be learned from the dissatisfied customers than from the glowing reports of the happy ones. So we thought you would be interested in Mr. Coleman's letter.

Sincerely,
Hal Hershey—Manager
Whole Earth Truck Store

Dear Bob:
Thanks for forwarding this letter to the factory as we can certainly use it to an advantage with our quality control people.

Mr. T. Coleman
Post Office Box 75
Casper, California

October 21, 1969
(Dict. 10/18/69)

Dear Mr. Coleman:

Thank you for your letter of October 6 advising the type of workmanship on the Model 23-CF Ashley Heater which you recently received.

The Ashley heaters have always been known for their superior quality and workmanship. It is certainly not our intentions that a customer should receive a unit which does not come up to these standards. However, when the human elements are involved, there is always chances for error.

We certainly appreciate fine customers like yourself who will bring these matters to our attention so that some action can be taken to see that the problems are corrected.

We are issuing an order for one Model 23-CF Ashley Heater to be shipped to you immediately on a no charge basis. I will personally inspect this unit before it leaves the factory and would appreciate your dropping me a note as soon as you have the unit installed advising if it is entirely satisfactory.

Please use this letter as authorization to return the defective unit to the Ashley Automatic Heater Company, Sheffield, Alabama, freight collect and marked to my attention.

Again, may we say we are very sorry for all the inconvenience caused you in this matter.

Yours very truly,
ASHLEY AUTOMATIC HEATER COMPANY
H. C. McMurray, Manager
Sales and Service

HCMc/bpg
cc: Mr. Bob Smith
Ashley-Spark Distributors
Portland, Oregon

November 19, 1969

"Full many a flower is born to blush unseen,
And waste its sweetness on the desert air."

Thomas Gray's Elegy

From Stanley Marsh 3 to Steve Baer 1

December 12, 1968

Dear Steve:

A stranger passing in the night lent me your book, *Dome Cookbook*, and I promised to return it to him by mail. However, after having read it, I decided to keep it until I could get my hands on one for myself. Please send me five copies of *Dome Cookbook*, and enclosed is a check for \$5.50 to cover mailing.

North of Amarillo, overlooking the Canadian River, I own a ranch. Through the ranch runs Tentmakers Canyon. At the point where Tentmakers Canyon enters the Canadian River, there are huge towering cliffs. I want to build a zome on this cliff overlooking the river and the canyon. I will go on week-ends with my wife and child to this zome and watch the deer and coyotes. It is one of the wildest areas in the Texas Panhandle. I want you to come to Amarillo, Texas, some day, and design it for me.

I will be in Russia hunting bears until after January 15th, and after that time, if you will call me collect at the above number, I would like to talk to you.

Very truly yours,

Stanley Marsh 3

I want you to come to my studio at 608 Polk on Friday, November 21, from 5 to 7 p.m. for a drink and snacks and hear more about the proposed Art Center in the Fine Arts Complex at Amarillo College. Would you please call the above number and tell us if you can come. Also you will be able to see an example of my theory of art and I thought I would write you about it.

The Taj Mahal is a wonderful piece of art and a BOON to all MANKIND because very few people have ever seen it. I'll bet it is AWFUL. Imagine riding in a hot and sticky car in India where there are a lot of flies and poverty to see it. I'll bet it is all gymnastic and spitty.

BUT, it is a SPLENDID thing for the world and all of us who have grown up to hear about the beauty of the Taj Mahal, the love of a prodigal maharaja for his wife, his plans for a matching black one, the proposed silver bridge and the long reflecting pool. Indeed, by its geographical obscurity, the Taj Mahal has enhanced the lives of millions of people.

I am now building a giant SOFT pool table 20X scale. The painted beach balls are forty inches in diameter, the straw-filled canvas cue is 100 feet long and will undulate across the felt, which will be green-dyed prairie hillside (80 feet by 160 feet). I will plow around the edges to look like wood and dig the holes.

When I first started this soft pool table it was to be built near a lake where I am building a house. It could be seen from Highway 66 and from certain tees at Tascosa Country Club. But, it is too important and too precious a thing to allow

Artistically signed,

Stanley

Fleshfeather wants to know

what is postmonetary economy?

fleshfeather

Good question.—SB

in case you haven't heard, St. George Bryan, retaining subscriber and brother, has been lost at sea off the island of Maui.

Gari Waters
Honolulu, Hawaii

Responsibility of Perfection

Young Ladies & Gentlemen:

The contents of your catalogue may quite possibly offer an attractive option in life styles!

Since I'm currently serving a four year enlistment in the U.S.A.F., it is no wonder that I have a real concern for my life's routine, pattern of living, et al.

My occupational bibliographic sketch or vocational-educational profile would suggest a career in electronics. However, I'm, by nature, discontent with the traditions of habitual conformity & security.

Your guide to living—*The Whole Earth Catalogue*—may suggest more versatile & exciting avenues or horizons from which to view the vigil of "the 8 to 5 p.m. city commuter." For in all honesty I prefer to spectate as oppose to participate in the above mentioned example.

"What am I'm living for?" Good question. I think I prefer an atmosphere of communal living with very tolerant & humane freedom to express one's views, manner of dress & choice of company. Perhaps an art colony.

I like a group that invites creativity & scorns bureaucracy.

Such a group must have purpose, meaningfulness, and imagination to each & every member aboard the crew.

It must be disciplined in the responsibility of perfection. It should not, however efficient, eliminate or ostracize one of its members on the grounds that he or she is not quite up to par with the rest. Rather, it should encourage & develop the latent talents & abilities that lie inert within all of us.

The tragedy of the human individual is that his spirit often dies long before his physical death (paraphrased from a quote by Albert Swietzer).

Please give me & others like me—a choice not a chance to decide what role we may play in our own self-fulfilling prophesy.

We do not scorn work. We do scorn exploitation & pollution of human materials. Help us rekindle that spirit that endowes all the great men—service to mankind.

Yours in spirit,
John L. Wilson III
Griffiss AFB, NY

From John Holt

Remember that washing machine I told you about. [from Proctor & Gamble] My niece got one, and says it works fine. I am going to order one myself, and will tell you more about it when I get it.

A note on the Hi-Fidelity front. Dynaco has come out with a new loudspeaker, their first. It sells for \$80 and is a humdinger. I consider it about equal in quality to the considerably larger, \$130 KLH-6, still one of the best in the business.

The Rectilinear Research Corp, 30 Main St., Brooklyn, NY 11201, has just come out with the Rectilinear-10, a \$200 speaker which I and people I trust now think is about the best speaker available at any price. I would say, if you can afford \$200, get that one; if not, the Dynaco.

Best,
John

people to know where it is, so I HAVE DECIDED TO HIDE IT.

I will fly in Italian craftsmen from Rome, blindfold them at the airport and drive to a secret location (which only I will know) to assemble it. I will then forget the location, or perhaps I will remember so to be able to move it from time to time.

It is TRUE, you know, that I am building it. At my studio you can see the pool balls, cues, rack and chalk. Photographs will be allowed, but only in part, so that people will know that it exists. It is much too important to be photographed in full. Of course, my table is too serious for any museum and too precious for Onassis.

The trains from the Santa Fe Railroad leave Amarillo at 12:30 a.m. and 5:00 a.m., and I may place it where train passengers could see it, only if the train were late. Of course, I would only leave it there for a few days because I fear the Santa Fe would soon run excursion trains to see it and we could not have that.

This giant soft pool table will be my GIFT to mankind. . . the same way the maharaja's gift of the Taj Mahal was. Children will know that perhaps some day when they grow up if their car breaks down and they are walking across the prairie, or if they were a cowboy riding across the plains, or a geologist looking for oil, that someplace in the Texas Panhandle they might see the world's largest soft pool table! WOW!

Wouldn't it be wonderful if a volcano covered it up as soon as it was made and only part of one of the balls was left to be seen?

Fish protein

Some time ago I read in Newsweek, and again in Dubos' *Man Adapting*, about a powder made from whole fish, defatted to remove the fishy taste, that was supposed to be about 97% high quality protein and cost about 3 cents a pound. It was going to help solve the world's protein shortage. The reason for the Newsweek article was that the FDA had just cleared it for distribution within the US. Since then I have heard nothing more and have never seen the stuff. Any help?

Don Symons
Primate Ecology
Lajas, Puerto Rico

Anybody know about this?

How to have a secure, rusty ax

Catalogue tip: If an axe handle loosens, immerse the axe into a bucket of water; the wood will swell and the axe will be as neat as new after a few dippings. By "few" I mean, of course nights.

I would buy your boffing kit, but I am a hermit; I have a one-man commune, and I don't dig to boff with bears.

Good luck—if luck ever comes to Menlo Park.

Love,
Vaughn Marlowe
Parksville, B.C. Canada

What if we run out of plastic ore?

Something that should be pointed out to Lloyd Kahn and all the people who are pushing plastics as the construction material of the future: plastics are a non-renewable resource. The raw material for making plastics is mostly oil and coal. The promise of plastics alone should be sufficient argument to convince most people that we shouldn't be burning up what remains of these important reserves. The important thing is that man learn to treat forests as we would any other crop; distinguishing of course, between recreational forest and economic forest. With proper management, further inroads into virgin timberland should be unnecessary. If population growth could be checked, we could even plant some farmland with trees. Right on.

Also, Right in there with *The Teachings of Don Juan*, *Altered States of Consciousness*, *Ideas and Integrities*, etc. should be Laing's *Politics of Experience* and Watts' *Psychotherapy East and West*. Whoever reviews them should have read them all.

Since most people seem to have books on dope sitting around, they should know that one of the most interesting, especially for the really esoteric stuff, is *The Ethnopharmacologic Search for Psychoactive Drugs* (Government Printing Office FS 2.310.2; \$4.00)

Also, for people that are into organically grown food, they should be told not to worry about using treated seeds, because once they're sprouted, the crap on the outside of the seed is minor compared to the crap that is everywhere. Organic food-food Natural vitamin pills are an incredible Rip-off; A Rif. Total B.S.

Sincerely,
Ken Colstad
Madison, Wis.

From Sally Campbell to Lai Ching,
whose address we lost

Dear Lai Ching,

I was so pleased to see your letter in the Whole Earth Catalog July Supplement. It's the paragraph about children's books that particularly interested me. You list many I haven't read and will try to get hold of.

To your question of how to obtain children's books cheaply I have two answers. 1) go to your library 2) investigate paperback books. Of course both solutions have their problems. You can't keep the library books forever, but then you can go out and buy only those you really want to own after reading them through. As for paperbacks not all the wonderful children's titles are available but you would be surprised how many are. They stand up remarkably well under hard use too. I'm a children's librarian (as you might have guessed from suggestion 1) and in my library where books are really worn the paperbacks do very well.

A few publishers you should investigate include *Scholastic Books*—they were the first to publish widely in the children's field but only sold to schools now some of their titles are available in bookstores. *Viking Seafarer*—a brand new line has taken over a few of Scholastic's titles and made them more handsomely, along with some new titles

Dutton—also brand new. They have a really handsome *House at Pooh Corner* for \$1.25.

Dell Yearling—consistently high quality in selection of titles and format. *Charlotte's Web* & many others

Puffin—*Penguin*—sadly most of their best titles are available only in England—you could get them from Blackwells though (see letter next to yours in Whole Earth Catalog)

Grolier—old picture books such as Potter & Greenaway. Lovely paper & print but the pictures not always as crisp as they should be. May be hard to find because they give book sellers low discount.

Dover—beautiful old items, including the Blue (& other color) Fairy Books but somewhat more expensive 1.25-1.95 *Harcourt* — *The little Prince*—in French & English both.

I wish I knew the San Francisco book scene so I could tell you which stores are most likely to help you. If you are ever in Los Angeles (I studied at UCLA for one year) you really should go to Campbell's Bookstore (no relation) in Westwood at the south end of UCLA's campus. If Mrs. Blanche Campbell is still there she'd have a wonderful time talking to you about books. For that matter if you plan to be in New York do let me know so we could talk about books. The best library in New York is the Kingsbridge Branch (where I work) and the best bookstore is the Eighth Street Bookstore (where my husband works.) We have a bookloving home.

My best to you and especially your daughter.

Sincerely,
Sally Campbell

The sour stomach of success

You have grasped a great idea. Don't let go and protect yourself. You will be submitted to all sorts of pressures to conform, change in someone else's direction, or pull your punches. Don't. Many of these pressures will be subtle or even invisible.

D. M. Moore
Galesburg, Illinois

Yup.

Air structure contractors

Birdair Structures, Inc. Cidair structures Co.
2015-Walden Ave 130th & Indiana Ave.
Buffalo, N.Y. 14225 Chicago, Ill. 60627

Air-Tech Industries, Inc.
9 Brighton Rd.
Clifton, New Jersey 07012

All the above companies made bids to Harvard to build their big air support athletic building. Air-Tech won the bid and built a quite impressive building.

This is the kind of thing new radical schools must look into.

Best,
John Holt
Boston, Massachusetts

Brown rice again?

Speciality food sells 100 pounds of brown rice (short grain organic) for \$15 & its quality is far above Walnut Acres. Quality in fact is on same level as Chico San & El Molino brands. (both several times the price.)

Speciality Food
116 W. Houston St.
N.Y., N.Y.

J. E. Dombroski
Washington, D.C.

Aircraft inspection

Recently I came across a publication from the GPO on aircraft inspection that might save a life or two, and it only costs \$0.50:

Personal Aircraft Inspection Handbook
FAA
1964; 71 pp.

It is intended for student mechanics, pilots, and aircraft owners who want to become more familiar with aircraft and inspection techniques. It contains valuable information for the pilot who just wants to preflight his aircraft and for the mechanic who wants to determine the airworthiness of one.

There's a lot to be learned from this book by anyone who flies an airplane. My flight instructor sure didn't go into all the detail inside. It explains what causes wear and tear, and how to check for it. Fifty cents is a pretty low insurance premium. If something goes wrong you can't just pull over to the side of the road and call the auto club.

Malcolm Blackhall
Carmichael, CA

Pure land & ecology kits

As an ethologist, ecologist and agriculturalist I would like to recommend that you stock the great little book, *Bees: Their Chemical Senses, Vision and Language* by the contemporary genius Karl von Frisch. The price is \$1.45 from Cornell University Press, Ithaca, N. Y. His experiments have no parallel in comparative psychology for simplicity and beauty of design. What makes this book relevant to your subscribers is that it will show them how to decode the secrets of animals at very little financial cost. I would be happy to review it if you wish.

The other thing I wanted to bring up is that I am the director of the NEW ALCHEMY INSTITUTE and our goals are to rebuild the land and protect the seas as well as inform the earth's stewards of the health of the environment. We are non profit and also act as environmental consultants. My own research will be described in a forthcoming issue of *Scientific American*. The NEW ALCHEMISTS have recently embarked on a project to prepare environmental idea kits for those who wish to inform themselves of the present state of the environment. At the present they are general but we hope to proceed into specialist kits, e.g. DDT or lead or ozone etc. We also hope to map North America for "pure regions" for homesteaders. Our own Loth Lorian experiment will involve several thousand acres in Nova Scotia and our survey to locate the region on the basis of environmental factors such as lead, PCB's, DDT fallout etc combined with agricultural suitability for replanting climax forests and eroded valleys has begun. By using a variety of organic techniques and our ecological savvy we hope to rebuild the land in fifty years or so instead of several hundred, or thousands depending on the soil type and rain. If man wakes up and doesn't destroy his environment and himself we might succeed, we might set a precedent. We are broke, exhausted and happy.

With my best wishes, I am
Sincerely,
John H. Todd
Department of Zoology
San Diego State College
San Diego, CA

Staff Gripe Page

The gripe page is a peace-keeping device where Catalog staff can make personal statements which the editor may not edit. He may add a remark or two.

We deal, by now, with innumerable suppliers, subscribers, customers. Most of the transactions are smooth and friendly—a pleasure. Ones that aren't you may hear about here.

Credit depts. of publishers who neither answer nor act upon requests for changes of errors on statements. e.g. John Wiley & Sons [since acknowledged]

Lois

Why isn't Meher Baba in the Catalog?

Joe

People who don't send us their change of address when they move & then want extra copies of Catalogs because they didn't get theirs.

Diana

Print (in Supplement) a challenge to the fellow who telephoned & called me a "Whore to the Businessmen of America," etc, etc. to a Boffing match & then let Stewart stand in for me.

Mary

I think we have just defined the role "pimp".
—Stewart

Cappy: Fanny Farmer isn't in; Ayn Rand is.

noting the catalogs choice of translations of the tao te ching i was a bit dismayed.....

having studied a little classical chinese myself and having read many xlations of the tao te ching, and in the spirit of Ezra Pounds "The Chinese Written Character as a medium for poetry" (city lights) and considering that E.P. knows a great deal about it, and having attempted translation of a few passages of the ttc, i heartily reject the notion of the concept of the tao being rendered as "nature and intelligence" and recommend instead a translation by Dr. Chung, published by the St. Johns Press.

thank you

tracy

People who don't check every box } on the subscription form.
" " don't " ANY " }
Poh.

Sometimes I don't care about nothing, but right now I do. It sickens me to think that over 150,000 people are going to pick up the Whole Earth Catalog and thoughtlessly think it's great, like I did.

The function of the catalog is to provide access of tools for and from the WHOLE earth. Roughly 80% of the peoples of this WHOLE earth are being sucked on by various capitalistic countries of this world. Yet for some reason the problems of these "third world" people are not even mentioned in the catalog. There are books and various publications written by educated and experienced writers on these problems and their solutions. I really don't think the title "Whole Earth" is quite adequate for the catalog at this point.

Stewart Brand, the man who originally erected and conceived the idea of a Whole Earth Catalog and truck store, does not seem to share my feelings that these types of political books and various publications should be included in the catalog. Once, while working with him on the catalog, I asked Mr. Brand if he would not carry any of a various number of politically oriented underground newspapers. Upon reply he told me that three of the first restrictions he made for the catalog were no art, no religion, no politics.

I would like to point out that, although Mr. Brand apparently does not seem to think so, all of the three basic ground rules he set up for himself at the beginning and told me of little over two months ago, he has broken.

To start with art and the contents of the catalog, just to name a few:

- Art Prints
- Art and Illusion
- The Très Riches Heures of Jean, Duke of Berry
- The Natural Way to Draw
- The Photograph: A Social History
- Film Making in Schools
- Pottery
- Tantra Art
- Macramé, the Art of Creative Knotting.

Then we move along to religion. Here we find only a few; The I Ching, Tao Teh King, The King and the Corpse. One could argue that these are not religious books as say compared to the Bible, but I do think one would find that they are mostly interesting to the religiously minded person. Lastly we come along to items of political significance. In this we find quite a few.

- Handbook for Conscientious Objectors
- The Population Bomb
- Population Evolution and Birth Control
- Birth Control Handbook
- Atlas Shrugged
- The Wall Street Journal and any number of "future" books.

I can understand why Mr. Brand makes such a distinction between, for example the Handbook for Conscientious Objectors and a good book on Marxian theory, it's because he's a capitalist. The inclusion of books on these subjects would hinder catalog sales, and after all it's not serving the people that he's interested in, it's making money, and believe me he has plenty of it. Besides it's against all his economical beliefs.

Yes Mr. Brand's personal feelings really show up in what should properly be called the "Stewart Brand Catalog." From all the 128 pages of the Whole Earth Catalog there emerges an unmentioned political viewpoint. The whole feeling of escapism which the catalog conveys is to me unfortunate.

I could go on about the unfairness which has occurred in hiring, firing and salaries at the truck store but I'll spare you.

Instead I'll say how I feel the catalog should be. It seems to me that the art department is o.k. A good religion section including all of the works of our avatar Meher Baba is deeply needed. And, you guessed it, a section concerning the repression and liberation of the oppressed peoples all over this whole earth.

The idea of the catalog is a good one. The people need a Whole Earth Catalog, but not the one they're getting! If you feel at all the same, write Stewart Brand.

Jai Baba

Jay Bonner

Counter gripe

Jay worked with his brother Joe doing layout on the Fall Catalog and was not rehired for January production because of too many technical mistakes on his pages. Jay is 17. (I'm 31. How old are you? It matters, more than any of us like.) Correct I have some money, thanks to parents, which I'm putting into work like the Catalog. My salary is \$5/hr. The Catalog is non-profit, so our income above expenses can only be spent on further educational projects. The capitalism question is interesting. I've yet to figure out what capitalism is, but if it's what we're doing, I dig it. Oppressed peoples: all I know is that I've been radicalized by working on the Catalog into far more personal involvement with politics than I had as an artist. My background is pure WASP, wife is American Indian. Work I did a few years ago with Indians convinced me that any guilt-based action toward anyone (personal or institutional) can only make a situation worse. Furthermore the arrogance of Mr. Advantage telling Mr. Disadvantage what to do with his life is sufficient cause for rage. I ain't black, nor poor, nor very native to anyplace, nor eager any longer to pretend that I am—such identification is good education, but not particularly a good position for being useful to others. I am interested in the Catalog format being used for all manner of markets—a black Catalog, a Third World one, whatever, but to succeed I believe it must be done by people who live there, not well-meaning outsiders. I'm for power to the people and responsibility to the people. Responsibility is individual stuff. My responsibility with the Catalog includes choosing what goes into the Catalog and who works on it, and sometimes that's enjoyable and sometimes it's not, such as when you have to fire somebody you like.

Stewart

Another change: Observers Handbook

Price given in Fall CATALOG was \$1.00. It should be \$1.50

from:
Royal Astronomical Society of Canada
252 College Street
Toronto 2B, Ontario
CANADA

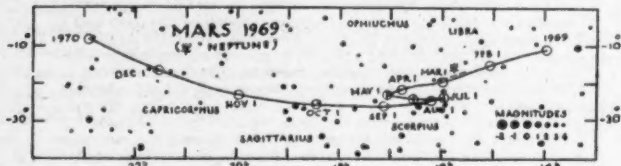

Another change: Green Revolution

Year's subscription price has gone up from \$3.00 to \$4.00

from:
School of Living Center
Heathcote Road
Freeland, Md. 21053

THE GREEN REVOLUTION

A MONTHLY JOURNAL FOR ENVIRONMENTAL ACTION AND SOCIAL JUSTICE

Environmental Defense Fund
Rules For A Community
How To Compost

Earth Flag

The Truck Store is mailing the Earth Flag minus stick because all the ways to mail it safely with stick are too expensive.

\$1.50 postpaid

from:
"WE" Inc.
19 Troutman Street
Brooklyn, N. Y. 11206

or WHOLE EARTH CATALOG



From brain to eye

When the eye is disconnected from the optic nerve in an undrugged experimental animal, impulses passing through the optic nerve abruptly cease. If an animal with detached optic nerve is given LSD, the impulses are somewhat diminished but nevertheless still occur. Since the optic nerve has been disconnected from the eye, these impulses cannot possibly be the result of external stimuli. What is seen is not found in objective reality, but arises from within oneself. This is what is meant by the term hallucination. Experiments conducted with totally blind human beings using LSD yield similar results.

From LSD-25, a factual account,
\$1 from superintendent of Documents,
U.S. Govt. Printing Office, Washington DC 20402

Food from Waste

An inkling of the broad vision and planning needed comes from a sleepy little Mississippi town called Bay St. Louis. There, a National Aeronautics and Space Administration facility was scheduled to be phased out. But government officials and Louisiana State University [Baton Rouge 70803] representatives worked out a plan to use the buildings, scientists, and a fraction of the usual budget for a fantastic new idea of food production. Using a bacteria strain discovered in a sugar cane field by an LSU associate professor of microbiology, the scientists attempted to convert cellulose waste products—corn cobs, grass, leaves, sugar cane residue, and even logs—into high protein food.

They succeeded. In contrast to a 1,100-lb grazing cow, which produces about 1 lb of protein a day, 1,100 lb (much more than they now have working) of their busy microbes could turn waste products into 12,000 lb of protein each day—and do it without adding to the environment's burden of pesticides and nitrogenous fertilizers.

"The stuff doesn't taste bad at all—something like egg yolk with a little salt in it," says Dr. Clayton D. Callihan, LSU associate professor of chemical engineering and director of the project. It analyzes down to 50% protein, and the rest cellulose, carbohydrates, and fat."

Dr. Callihan is jubilant: "I know we already have some good cattle feed. If we ever get FDA approval, we could have human food. And we've found we can convert old books, rags, newspapers, and magazines, too."

[Item from unknown magazine sent to us by Phil Less in Berkeley]

The space out

"A nuclear holocaust on Earth would still be an unspeakable tragedy, and might still wipe out 99% of our numbers. But the 1% who had dispersed could not be wiped out simultaneously by any man-made catastrophe, and they would remain to carry on the promise of our destiny. Perhaps some of them would also come back to repopulate the Earth, after the radioactivity had cooled. I at least find it a consoling thought that the human race will one day be invulnerable, that we have only to survive this awkward period of a century or two between the discovery of nuclear weapons and the large-scale expansion of our habitat, and then we shall be masters of our fate, freed from the threat of permanent extinction."

The recovery of an open frontier seems to Dyson to be the deepest benefit that space offers. But he doubts that most people will go to Mars and the other planets.

"I do not think planets will play the major role in man's future," he states. "For one thing, they are most uninhabitable. For another thing, even if they are habitable they will not increase our living-space very much. If we succeed in colonizing Mars, Mars will soon resemble the Earth, complete with parking lots, income tax forms, and all the rest of it..."

"I believe the real future of man in space lies far away from the planets, in isolated city-states floating in the void, perhaps attached to an inconspicuous asteroid or perhaps to a comet."

Each comet is a mine of biologically useful materials and together they provide a thousand times as much living space as the planets.

"Above all they provide an open frontier, a place to hide and to disappear without trace, beyond the reach of snooping policemen and bureaucrats... Space is huge enough so that somewhere in its vastness there will always be a place for rebels and outlaws... Perhaps most important of all for man's future, there will be groups of people setting out to find a place where they can be safe from prying eyes, free to experiment undisturbed with the creation of radically new types of human beings, surpassing us in mental capacities as we surpass the apes."

(See "Human Consequences of the Exploration of Space" by Freeman Dyson, Bulletin of the Atomic Scientist, September 1969)

From *The Futurist*, December 1969, \$7.50/yr (bi-monthly)

from:
P. O. Box 19285
20th St. Station
Washington, D. C. 20036

Kill-or-Cure Method for cleaning goked-up typewriters:

Remove ribbon, swab typewriter inside & out with Gunk Auto Engine Cleaner. Allow Gunk to work for about 10 minutes, then blast off gunk and Gunk water. Dry immediately with compressed air.

Works fine with regular typewriters—rumored to have worked ok with an electric.

L. B. Holman
Tully, N. Y.

Cyclops

When ewes ate false hellebore on the 14th day of pregnancy, lambs were born with one eye in the center of the head. If ewes ate the poisonous weed one week later in gestation, lambs were born with leg deformities. Cows were most likely to have calves with birth defects if they ate beanweed, or lupine, between the 40th and 70th days of pregnancy.

from *The Progressive Farmer*, Jan. 1970, \$2/yr (monthly)
from:
821 North 19th St.
Birmingham, Ala. 35202

Computer image

A computer system, developed for film and tape animation, could soon have a number of interesting applications in engineering R & D—simulating mechanisms and studying their operation.

Computer Image Corp., 2162 S. Jason St., Denver, Colo., has, in fact, designed two systems. One, called "Animac," is capable of generating its own images for animation. It was developed specifically for producing full-length cartoon motion pictures. The other, a smaller, simplified unit called the "Scanimate," can produce animated television commercials, films and video tapes, but it requires original artwork to start with. It has a TV camera that transfers the basic image from artwork to computer's cathode ray tube.

With either unit, the image can be exploded, zoomed, twisted, squeezed, undulated, or pulled through itself. The original drawing is only the beginning for a progression of combinations, juxtapositions, and transformations, as this example shows.

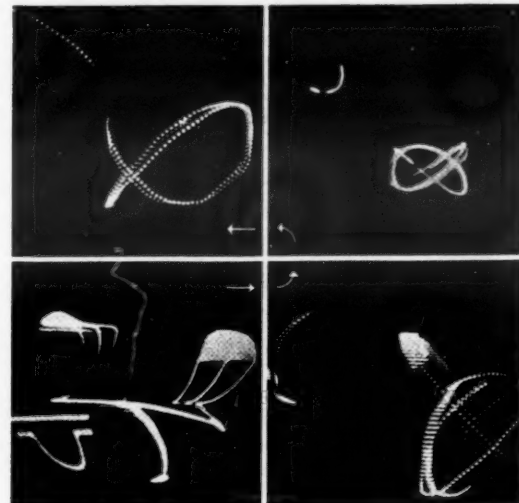

Computer Image is now using the systems to make films at its Denver plant. But, by spring, it expects to have enough units built to begin leasing and franchising them to interested organizations.

Note: For more on computer graphics, see *PE*—Aug. 25 '69, p 86. (1.24, 6.34, 4.444)

From *Product Engineering*/November 17, 1969, \$15/yr (bi-weekly)

from:
P.O. Box 430
Hightstown, N. J. 08520

Skintight

A farmer at Hood River was loading a cluster of us tramps into his pickup for an out-of-town "spot job." (A spot job is a short job picked up on the street.) One Slim had no bag, no bedroll, not even a cap. The farmer hollered over at him, "Hey, fella, where's your suitcase?" "Sir," said Slim, "I'm standing on it!"

Ah so! So are we all. Scientist, seer, citizen, tramp. None of us can jump out of our skin and be purely objective. We're all standing in the human ground. And that's the only place we do stand. All the rest is wobbly, phony, topheavy. "To be thoroughly human—that's it," says Jalal edDin, "all the rest is longwindedness."

From *Moving On*, \$2.50/yr
from P.O. Box 1349, San Francisco, CA 94101



NOTICE!

NOTHIN BUT THE TRUTH KIDS
OR
ITS GOTTA START SOME PLACE



ATTENTION: COMMUNES, EXTENDED FAMILIES, GROUPS, TRIBES, FAMILIES, LONERS

PEOPLE

SUBJECT: HEALTH & SANITATION OR SANITATION & HEALTH

IT IS RAPIDLY BECOMING CLEAR THAT IF WE DO NOT PAY ATTENTION TO SOME BASIC FACTS ABOUT HEALTH & ITS RELATION TO SANITATION WE ARE GOING TO HAVE SOME PROBLEMS. THESE PROBLEMS WILL NOT/CANNOT & WONT GO AWAY. NEITHER CAN WE. THERE IS NO WHERE TO GO. PEOPLE THRU OUT TIME/SPACE HAVE ALL WAYS HAD TO DEAL WITH THESE PROBLEMS.

SO

PEOPLE EAT FOOD WHICH MAINTAINS BODY WHICH REJECTS WHAT IT CANT USE AS WASTE

WHAT TO DO WITH IT OR HOW TO GET RID OF IT
THE EASIEST WAY IS TO LEAVE IT WHERE YOU LAID IT. PROBLEM: SOMEONE ELSE HAS TO COPE. DONT PASS YOUR LOAD ON. WE ARE ALL ONE. WHATS YOURS IS MINE. AN OTHER EASY WAY IS TO PUT IT IN THE RIVER/STREAM/DITCH. YOUR STILL PASSING ON YOUR LOAD. REMEMBER WATER EQUALS LIFE. WHO WANTS TO DRINK WATER WITH YR. LOAD IN IT. THERE IS A GOOD SOLUTION PUT IT IN THE GROUND. GIVE IT BACK TO MOTHER NATURE SHE CAN USE IT (NITROGEN ETC.)

DIG A HOLE

BUILD A LITTLE HOUSE OVER IT. KEEPS THE RAIN/SNOW OFF. SCREEN IT TO KEEP FLYS OUT (IN?) DONT SHIT WHERE YOU EAT OR EVEN NEAR IT. DONT PUT IT UPWIND OF YR. KITCHEN. FLYS FLY. DONT PUT IT WHERE IT WILL LEACH INTO GARDEN. PUT IT SOME PLACE WITH A GOOD VIEW. LET GO IN BEAUTY. KEEP A CAN OF LIME INSIDE. (HARDWARE STORE HAS IT) USE IT! SPRINKLE A COVER ON EACH LOAD. COVER HOLE/SEAT. SQUAT OR SIT. WASH YR. HANDS WHEN DONE. HEPATITIS & DYSENTERY ARE SPREAD THRU FECAL MATTER. WHEN YR PILE GETS TOO BIG MOVE HOUSE BURY REMAINS OR USE CAUSTIC SODA. KEEP A WAY FROM KIDS IT COULD KILL THEM. GEN'L STORE SELLS IT & DIRECTIONS FOR USE. OTHER SYSTIMS AVAILABLE CHECK C.I.C. OR LIBRARY. THEY COST & WASTE WATER (5 GALS. A FLUSH) BUT! YOU MUST DEAL WITH SHIT. DO IT WELL! DO IT NOW! TOMORROW NEVER GETS HERE.

JUST BECAUSE YOU DEAL WITH DONT ASSUME I DO. OK?

KNOW WHERE YOUR WATER COMES FROM. A DITCH/STREAM/RIVER IS MOST LIKELY POLLUTED. IF THERE IS NO OTHER BOIL WATER OR USE PURIFICATION TABS. CHINEESE ADD HERBS CALLED IT TEA. THERE IS NO WAY AROUND CONTAMINATED WATER. IT IS OR IT ISN'T. IF POSSIBLE FIND A SPRING. HAUL IT IF YOU HAVE TO. 5 GAL MILK CANS ARE GOOD. IF YOU DRILL OR DIG A WELL CHECK LOCATION FOR NEARBY SEPTIC TANKS, OUT HOUSES ETC.

NEXT

DISHES & UTENSILS—EASY AS 1. 2. 3. WASH, RINSE, STERILIZE.
IF SOME ONE IN YR. WHATEVER IT IS IS SICK IF YOU DONT DO THIS YOU MAY BE NEXT. DONT BE PARANOID 1. WASH DISHES. USE BIODEGRADABLE SOAP (CHECK GEN'L STORE FOR INFO. DONT USE DETERGENT. ITS A POLLUTANT. IT GIVES YOU THE RUNS. RINSE OFF EVERYTHING. WASH & RINSE USE HOT WATER. IF YOU DONT HAVE A STOVE BUILD A FIRE. IT CAN BE DONE. AFTER RINSE STERILIZE. THIS IS ESSENTIAL METHODS: BOIL—AT THIS ALTITUDE ADD SALT BOIL 40 MINUTES NO LESS. USE CLOROX. WORKS BUT LOUSY AFTERTASTE. USE GERMICIDES SOME OF WHICH ARE BIODEGRADABLE. FOLLOW ALL PRINTED INSTRUCTIONS EXACTLY THEY CAN BE DANGEROUS. BY BIODEGRADABLE IS MEANT—IT BREAKS DOWN BIOLOGICALLY, REUNITES WITH ORGANIC COMPOUNDS. CHECK RECENT MAGS FOR PICS OF DETERGENTS IN OUR RIVERS. PRETTY!

IF YOU GET SOME "THING"

HEPATITIS, DYSENTERY, VD ETC. GO TO LA CLINICA OR YR. DOC. TAKE YR. MEDICINE TELL THOSE WITH WHOM YOU LIVE/LOVE WHAT YOU HAVE/HAD THEY MAY NOT HAVE TO GET IT TOO! DOCTORS ARE US TOO. ALLOW THEM TO SERVE THE PEOPLE. HELP THEM.

FINALLY

KNOW & UNDERSTAND

THESE FACTS ARE NOT UNIQUE TO ANY GROUP. THESE ARE REALITIES WE ALL MUST FACE

NOTHING WRITTEN HERE HAS TO DO WITH GOOD OR BAD. ITS COMMONSENSE. IT HAS MOST SIMPLY TO DO WITH YOU & ME & HOW WE ARE GOING TO LIVE

TOGETHER

WITH EACH OTHER & OUR PLANET.

IN BEAUTY/PEACE/LOVE/CO-OPERATION.

from Taos underground newspaper. Sent by Joe Bonner

Haste made waste

It may be that some of the difficulties at the Altamont Rock Festival transpired because the organizers didn't take time to make the proper preparations. Such would be: Formally asking the local Earth-Spirit for permission to use his space; requesting indulgence of the grass, insect, and bird beings whose homes and bodies would be trampled on; expressing gratitude to the sky and air spirits and all living beings for their presence; beginning the gathering with a blowing of conches, and mantras and spells of love and peace; ending it with a prayer of thanks. Such was all done at the Gathering of the Tribes—the first Be-In—in Golden Gate Park. —G.S.

Earth Read-out, 439 Boynton, Berkeley, CA 94707

Curta Calculator

The address we gave in the Fall CATALOG was insufficient if you want a calculator from the Curta Company. Make it:

The Curta Company
14438 Sherman Way
Van Nuys, California 91405

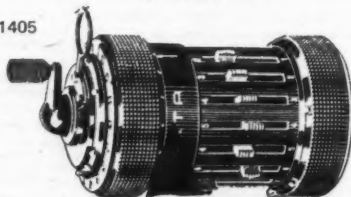

Tools at University of Illinois

Most people come here to get educated. A few come to get the tools they need to do the things they want to do. To these few: here are some two-legged tools; they are recommended by your peers. This is by no means a complete list of the good people here, but a start. Use them. Tear up your advance enrollment sheet and start over.

Babb, Daniel	Electrical Eng.
Beckett, G	Econ.
Brun, Herbert	Music
Cage, John	Music
Chanler, Josephine	Math
Cherrington, Blake	Electrical Eng.
Coitz, Laus	Math
Costello, C.	Rhet-English
Erich, Richard	English
Exline, Gerald	Architecture
Feinberg, Walter	Education
Fisher, Rob	ART
Gambill, Norman	Art
Ghent, A. W.	Biology
Gold, Louis	Pol. Science
Gottheil, Fred	Econ.
Gould, Orin	Education
Hensler, Gary	Math
Hilsdorf, Hubert	Civil Eng.
Jackson, Boyd	Counselor, Reading Clinic
Jackson, Herbert	Art
Kieffer, George	Biology
Kleinman, A	English
Mast, Plessa	Elec. Eng.
Long, Norton	Pol. Science
McDonough, Craig	Econ.
McPhail, Clark	Sociology
Millar, James	Econ.
Miller, David	Biology
Nievergelt, Jurg	Computer Science
Noclarse, Samuel	Psycholinguistics
O'Halloran, Thomas	Physics
Perrino, Daniel	Dean of Students Office
Powell, George	Math
Purves, Alan C.	English
Rosenberg, Wolf	Music
Sanders, Charles	English
Schiller, Herbert	Communications
Shakhashiri, Bassam	Chemistry
Smock, H Richard	Off. of Instructional
Slotnick, Daniel	Computer Science
Stegemeier, Henry	German
Sticker, J.	Chemistry
Sweemey, A.	Zoology
VonFoerster, Heinz	Elec. Eng.
Wetmore, Louis	Urban Planning
Wetzel, John	Math
Werner, Louis	Philosophy
Wilkie, Brian	English
Winklehake, Claude	Architecture
Woelfel, Joseph	Sociology

from the Whole University Catalog, made by Heinz von Foerster's Heuristics Class at University of Illinois.

Important change: Birth Control Handbook

This outstanding booklet is published by the students at McGill in Montreal. We indicated in the Fall CATALOG that you could get them from us, but you can't, because we can't get them in quantity from Canada, due to some copyright problem with the border. However you can order single copies direct from McGill.



Birth Control Handbook
McGill Students' Society
1968, 1969; 46 pp.

individual copies free plus postage (10¢),

from:
Students' Society of McGill University
3480 McTavish Street
Montreal, Quebec
CANADA

We Are Stranded On an Island in Space

September 20, 1969
 Jerry Mander
 Aspen, Colorado
 John Muir Institute Seminar

Everyone talks about the Earth being round, but does anyone actually believe it? Maybe the problem in really getting the idea has to do with understanding the nature of roundness, which is that you eventually get back to the same place. That is, there's nowhere else to go; that's all there is. There is no infinity.

People who live on islands understand the phenomenon very well.

I have some friends who about three years ago moved to Hawaii after living most of their lives on the mainland, and who recently wrote me that they are suffering from island sickness, a common syndrome of expatriate mainlanders, which is to spend weekends driving clear around the island, maybe more than once, thinking that eventually some new direction will appear, but it never does.

The natives of Hawaii don't have this problem I am told, and as I've just returned from the tiny islands in Micronesia, I can tell you that most of the natives there don't have the problem either.

They know perfectly well what finiteness means and, still undazzled by what we westerners know is true—that technology can accomplish anything—simply don't think about getting off the island. Well, in history there have been some brave souls in outrigger canoes who attempt to cross the seas to see if they can make it, or to see what's on the other side. You might think of them as the astronauts of the islands, but the difference between the islanders and us is that they don't put much faith in those canoes ever getting back in time to feed anybody next year, or at all, but I think we are all so technology crazed that some of us may actually believe our astronauts will lift us all off of here the day before we all starve to death. Never mind such easy matters as farming the oceans to feed an infinitely growing population, as though the oceans were infinite.

Micronesian "out-islanders" in particular—that is, those who live across a hundred miles or more of sea from any neighboring islands, and whose contact with the rest of the world is limited to the few souls who arrive on the eighty foot government boat every six months—simply don't think about infinity, or to put it more accurately, the idea that everything is possible.

In order to survive out there by themselves, they've had to gain a pretty good feeling for pacing the breadfruit production and the coconut eating. In some of those places the highest crime is cutting down a coconut tree without communal permission.

And on the islands surrounding Yap—where a culture thrives that is as nearly untouched by non-island ideas as any in the world—there is a very rigid birth control which works this way: Everyone gets married very late—late twenties or early thirties. While there is no particular emphasis on virginity until then, there is plenty of emphasis and sanctions against illegitimate children.

No man will ever marry a woman who has given birth first, and consequently the ladies have devised an intrauterine device made of hibiscus bark which works as well as the plastic ones and I'll bet doesn't cause cancer.

What I'm talking about, of course, is balance between man and environment. In some places it still exists and in other places it doesn't and I'm suggesting that perhaps it's time to take as a model for our future survival-thinking the way islanders have managed to do things, because that's what we're on, it's round, and there's only so much of everything and in general people haven't realized that.

CP Snow alludes to all this in "State of Siege" where he describes the generalized anxiety that everyone, but everyone, seems to be feeling these days and says that it is caused by "condensation," that is, the Earth is getting smaller, and there's no place to hide and so people are getting panicky, forming communes on mountaintops, becoming ever more isolationist, not leaving their neighborhoods, not leaving their homes at night (with good cause) and so on.

Of course it isn't really condensation, it's just condensation of the mind. What's happening is we are all living through one of our most terrifying dream horror fantasies: We're locked in a room, and the walls and ceiling are closing in on us. All the things we've been raised to worship—Man's limitless power, the ever-giving nature of Mother Earth—all those infinite possibilities, are beginning to seem less infinite, in fact the infinite horizon is heading this way fast. We should have known all that the minute Columbus did his thing.

I dare say most of us in this room have probably, though perhaps only recently, begun to perceive that, but what about everyone else?

The major struggle in conservation is obviously what the black studies demonstrators called "the need for reeducation." In other words, it is a propaganda problem. And, I believe, the propaganda goal might very effectively be defined as this:

Develop an island psychology in everyone on Earth. Maybe we should start by giving a few professorships to the out-islanders of Yap.

But the trouble with that is, as soon as the Yapese arrive (as some of course already have, as students in our colleges) they are dazzled by such things as roads, and cars and most especially, by the way, canned fish. It's reverse culture shock . . . they are prepared to give up their house by the sea, their leisure economy, their abundant fruit and relaxed loving life—in other words everything all us businessmen have been working for—for a Yamaha motorcycle.

They will be (and are being) as dazzled by technology as we have all been because they have never articulated a value judgment to themselves about which way of life is better. They have only known one and are stunned by the one, much as a fish is stunned when he sees your face mask shining under the water. He doesn't notice the spear.

So in a way while not needing re-education, they are really in need of, let's call them, island appreciation courses . . . so if they do opt for plastic culture they'll at least know there's no getting the other back. I'm not kidding about this. The educational problem is as serious for islanders who already know how to survive on islands and who can teach us what we need to know, as it is for the rest of us, and if there are any young activist SDS hippie anarchist conspirators in the audience, I would respectfully urge you to go and shut down some colleges until they institute Departments of Green Studies on your campus, and make it requirement for everyone, but most especially students in science, engineering, business and government . . . who, without it, can do the most harm.

SMITHSONIAN
 INSTITUTION

CENTER
 FOR
 SHORT-LIVED
 PHENOMENA



60 GARDEN STREET
 CAMBRIDGE, MASSACHUSETTS 02138
 UNITED STATES OF AMERICA
 CABLE: SATELLITES NEW YORK
 TELEPHONE: (617)-864-7911

THE PURPOSE OF THE CENTER

The Center For Short-lived Phenomena may be described as an early alert system and clearing house for the reception and dissemination of information on short-lived natural events such as volcanic eruptions, major earthquakes, the birth of new islands, the fall of large fireballs and meteorite showers, major short-lived environmental pollution, and sudden changes in biological and ecological systems such as animal migrations and colonizations.

The Center was established to improve opportunities for research by providing an organization whose function is to collect and distribute information on short-lived events while environmental changes are still occurring. Rapid receipt of event reports may permit research teams, with their instruments and equipment, to enter event areas in as short a time as possible to collect important data that might otherwise be irretrievably lost to science.

Center participation in events includes contact with event areas, obtaining information and data on the events, interviewing reliable witnesses in event areas, collecting photographic and cinematographic documentation, issuing event notification reports and cables, event information reports and cables, continuing event status reports, final event reports, and preliminary results of field investigations.

COMMUNICATIONS SYSTEM

The Center has access to the responsive international communications system of the Smithsonian Astrophysical Observatory which is capable of reaching virtually any point on earth within minutes. This communications ability enables us to contact event areas quickly and to notify scientists of events while they are still in their early stages. The Center has developed a capability to respond quickly to event reports and is currently able to report most significant events within a matter of hours after they occur.

CORRESPONDENTS OF THE CENTER

In order to establish an effective global reporting network for short-lived events, the Center has invited scientists in many disciplines and from many countries of the world to join the Center as correspondents. These correspondents receive reports on short-lived events of interest to them and in return report short-lived events occurring in their respective areas. Correspondents are scientists, scientific institutions, or field stations that cooperate with the Center by reporting events, obtaining follow-up information about events that occur in their areas, traveling to events occurring in their area to make up-to-date reports to the Center, and occasionally providing assistance to research teams that might be sent to investigate events in their areas.

The Center now has over 2000 correspondents located in 122 countries on every continent.

SERVICES OF THE CENTER

Event Notification and Information Cards

The Center notifies subscribers of the occurrence of short-lived events through the issuance of Event Notification and Event Information cards. These cards are issued within 24 hours of the receipt of the event information by the Center and are immediately dispatched to subscribers. Event Notification cards contain initial information on the occurrence of current or recent events. Event Information cards contain additional information and data and the current status of continuing events and/or preliminary results of field expeditions. Subscribers indicate the field they are interested in (earth sciences, biological sciences, astrophysical sciences, archaeological sciences, anthropological sciences) and receive Event Cards that pertain to their field of interest. Event Cards are primarily intended for research scientists, research centers and laboratories, university departments, and teachers. Archives, libraries, news media, government departments and environmental research centers may wish to receive all event cards issued by the Center.

Suggested by Bill Hutchison
 Cambridge, Mass.

World Game

The only coverage we've seen of the "World Game" workshop in New York last summer organized by Ed Schlossberg (Buckminster Fuller spent 3 weeks on it) was a 3-page article in *Think*, the IBM house organ. Marty Blumsack sent us a copy.

Who has information on how the big World Game is coming in Illinois?

"This is not an exercise in politics," Fuller said to the under-30 group. "We want to have the answers ready when the politicians are in trouble and turn to us. . . ."

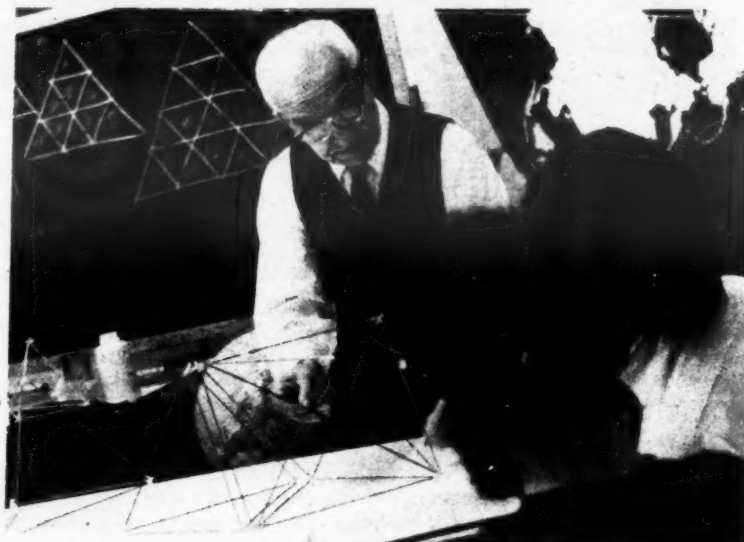

from Nov. 69 *Think* (bi-monthly), IBM, Armonk, N.Y. 10504

Then, all of us Establishment types can start agitating for something a little more respectable sounding: say, Departments of Humilities.

The Humilities curriculum would be the opposite of the sort of curricula black studies departments have lately been introducing, whose goals are to help some people feel their potency for the first time. The Humilities courses would strive to develop a little more feeling of impotency. Respecting the limits of things, most especially our technological toys.

I realize that the title of my talk, as printed and handed out, had to do with expanding the individual so as to reduce his environmental demands, so I'd better throw in right here the observation that if all of us recognized our quite limited place in the order of things, we might relax a little, getting-ahead-wise, and find there was time for some other joys we've only barely heard about. I didn't meet any Yapese that I could describe as unhappy and they seemed to fill their day quite satisfactorily without any of the accoutrements we find necessary. I'm not advocating any return to nature philosophy, though that's not a bad idea, but I am saying that we don't have to wait for the computer-operated robot men we will soon create to turn on us and enslave us like the movies say they will. Their technological parents already have. But let's leave mind expanding to the tea-groups for the moment, and get back to Humilities. Dave Brower has begun the fight beautifully I think. I have heard him speak more than once the nonsense of our current economic and political rhetoric, exhorting towards "a vigorous expanding economy." That has to be the first infinite idea to go.

And I like the implications of Dr. Hardin's Pregnant Pause very much and I believe it would work, if pushed hard, but the problem is so basic to Western thinking that we must all face the fact that re-education means everything, starting in grade schools with some kind of environmental studies . . . maybe even nature walks, depending on who's doing the leading.

So it's the schools that in the long run are most important, but still, what about meanwhile? Can we really wait for all those children—educated better than we are—to grow up and save us?

Of Course we cannot and I for one am committed to the use of media to get across the message, which, as an ad writer, let me put this way:

WE ARE STRANDED ON AN ISLAND IN SPACE: WE ARE RUNNING LOW ON FOOD AND WATER: AND (with due credit to Dr. Snow) WE SEEM TO BE GOING CRAZY.

It's the island part that I think is most important. If we can convey that notion, somehow, in a mass way, the islandness of things, we may have to live through some mass hysteria while people drive around (or fly, perhaps) aimlessly, but once they get the idea that it's all a big circle, the race may survive. If we all go under that won't stop the regenerative process, so let's be clear that it's people that are the endangered species.)

I never thought I'd be glad about the flight to the Moon, but in spite of its absurdity, in my view, considering the other needs of the day, it may yet turn out to be the critically important thing from a conservationist's viewpoint, because it may accelerate the idea of Earth as an island.

It seems to me that if we can get enough pictures of Earth taken from space, and the further away the better, the more the context will sink in. We are isolated in all that blackness. We can never, as a race, make it across that sea. This is the only place we have and these people on this globe are our only possible friends and lovers.

We proposed once before in a Sierra Club ad the idea of an Earth National Park; a wildlife island in space, where we are the wildlife. It is our only possible home and perhaps we should practice thinking about it in those terms and thinking of more ways to pass it along.

Thank you.

Technical Supplement

The following are excerpts from a supplement to the Willamette Bridge (Portland's underground paper) printed last July through Portland E.A.T. (Experiments in Art and Technology.) Copies are available for 25¢ from:

Jack Eyerly
1990 S. W. Mill St. Terrace
Portland, Oregon 97201

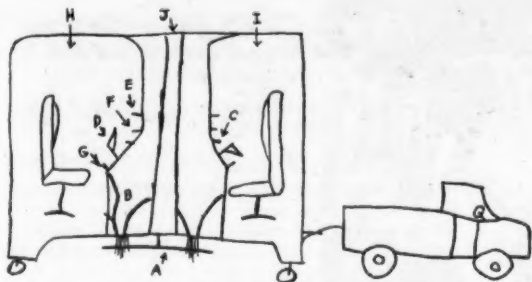

The Jet Propelled Kennedy -Stanley Jones

A. Propeller. B. Jet engines and jets. C. Lever to let ship loose of truck. D. Steering. E. Up lever. F. Sideways lever. G. Signal for truck to go. H. Teacher compartment. I. Student compartment. J. Where ship breaks in two for dual controls so student can learn to fly.

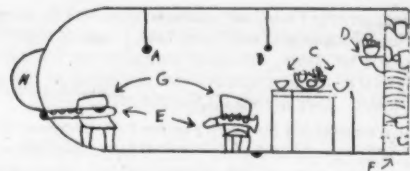

The Musical Bullet

-Ruby Dell halton (clarinet)
-Kathy Volkman (flute)

Playing the clarinet makes it go up. The flute steers it.

- A. A control for the flute to play it while eating.
- B. A control for the clarinet ditto.
- C. The dinner table.
- D. The food shelf.
- E. Flute and clarinet.
- F. The panels for the wires for the lights.
- G. The chairs.
- H. The window.

Fifth Grade Flying Machines and Airships



Dayton Grade School

Mr. Kennedy
Chief Engineer

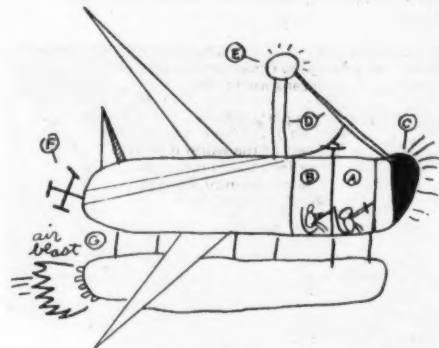

Sun Machine -Denny Downs

The men at control room A flies at day time. The men at control room B flies at night. The copper ball at letter C gets hot from the heat of the sun and air friction and the heat goes through tubes (D) by a blower and the antenna reflects (E) heat and sends it to the propeller (F). At night time the man in control room A turns on the air blast (G) to fly at night. It has wings and floats.

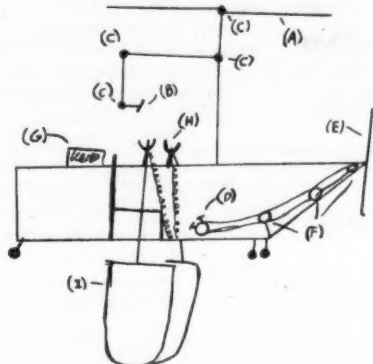

The Gear Machine -Steve Armstrong

It works by man power. To make the first propeller (A) run you take the first pedals (B) and pedal like you're riding a bike only with your hands. The gears (C) are to hold up the chain which runs the propellers. The second pedals (D) are to run the second propeller (E). The gears (F) are to help run the propellers.

The parachute (G) is in case of an emergency. The car holders (H) are to hold up the wings (I). The wings are for gliding.



Dayton, Oregon
March, 1969

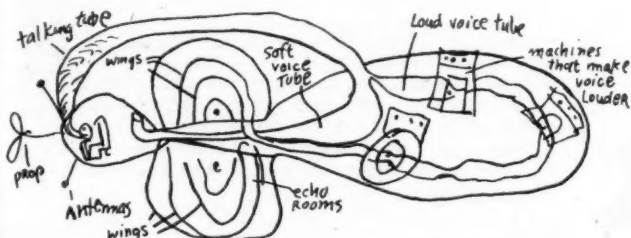

Talking Flying Machine -Sylvia Gusman

You talk into the talking tube and it goes back and the soft voice noises go into the soft voice tube and go around up front and out a hole. The loud voice noises go in the loud voice tube and through machinery that makes it louder, and then it goes into the echo room where the noise shakes kind of bird-like wings and makes it fly. The louder you talk the faster the machine will go.

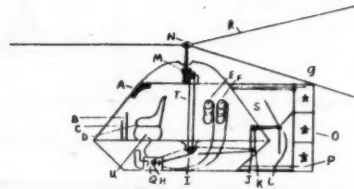

The Engine Raider -Bob Leppin

- | | |
|---------------------|------------------|
| A. Control panel | L. Wheel |
| B. Up-down throttle | M. Wheel |
| C. Forward throttle | N. Wheel |
| D. Chair | O. Rudder |
| E. Oil tank | P. Rudder string |
| F. Water tank | Q. Engine |
| G. Rudder string | R. Blades |
| H. Wheel | S. Blades |
| I. Wheel | T. Balts |
| J. Wheel | U. Gasoline tank |
| K. Wheel | |



Heartbeat Wings -Debbie Martin

You put the wings on your arms and hook two wires to your heart. But get them from a doctor. Then put the wires on a part of the wings. When your heart beats the wings will!

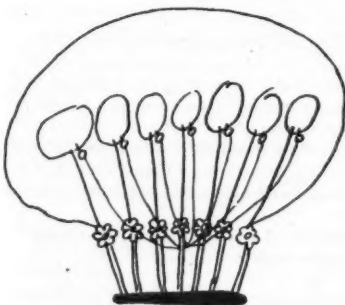

The Flying Flower Ship -Gee Roth

It's a machine that flies. One person in it. You can stand or sit down or lay down and go to sleep on the flying carpet bottom. It has seven balloons. It has steel poles around it with hard flowers on the ends. The balloon string is tied onto the poles. You pop all the balloons if you want to go down by pulling a string sticking needles in the balloons. Then they all fall down and you go down by parachute. The flowers are just to look pretty.

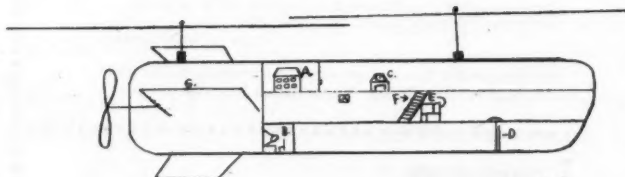

Feather Ship -David Noto

Letter A has a certain rod to make the propellers go. Letter B is the captain's quarters. Letter C is the radar for anything above it. Letter D is a pole that they slide down. Letter E is some boxes of supplies. Letter F is the stairway to get supplies. Letter G is the guiding fins that make it go straight.



The Flying Carpet -Gene Holdredge

- A. A box that makes it go.
- B. The flying carpet.
- C. A chair to sit in.
- D. Rudder.

How it works:

You put a jar of bees in the box by the chair and it goes up, and the wind pushes it and the rudder steers it.

Peradam

Peradam was an event held last Autumn Equinox to bring people from technological and long-haired worlds together. It was styled after Alloy, the event organized by Steve Baer in New Mexico at the Spring Equinox, and some of the same people attended. (See March 69 Supplement.)

Peradam was assembled by Dave Evans of the Augmented Human Intellect group in Menlo Park. The gathering took place in a wooded canyon near Santa Barbara. The 3-day meeting did not have a particular program, and suffered for the lack. Also Alloy was a tough act to follow.

Participants came from SRI, Zomeworks, Portola Institute, Pacific High School, Parnassus Institute, Hog Farm, Ecology Center, Southcoast, Beckwith & Langsner, Office Design, Placitas, and etc. Steve Katona cooked.

Here's some of what was said. The strongest stuff came from students and teachers from Pacific High School.

How do you continue to live a life of learning once you escape the institutions set up for learning?

Guerilla theater is usually about something that's already up that isn't satisfactory.

It's not enough to protest. We're trying exemplary forms.



Monks from the Zen Mountain Center.

It's the problem of being an American, to be sitting here with a full belly while the rest of the world starves.

The Playboy guys came by and said they wanted to take pictures, and we said we wanted a well, and they said you got a well.

We've been forced again & again to the old religious truth.

We've become anal about our own gifts. We're afraid we might bruise ourselves.

Computers are beginning to give the mechanistic world a brain. And it's our job to give it a soul.

All I know is, when you fuck a robot, you gotta get a shot for lockjaw.

The machine doesn't solve all our problems, it gives us more problems than we'd have without it. Like the first airplanes. It'd be easier to ride a horse.

We're gonna choke on our own self-satisfaction. Any of the things we do have an active life of about a year. It may be on the order of a natural jaw. Maybe people shouldn't have a sense of failure. . . . The things that sustain us are the trickle of information, but what pushes us on are the new surges. Get what you can out of it & move on.

They zoned Soleri's place as habitable sculpture.



We got a lot of myths we plug into.

Tires can be made into sandals.

Sex & violence are kind of related. (Girl in the audience:) No shit.

Something deeply in the heart of language is what's fucking us up.

Jail is the national monastic center.

You learn something different when you do it yourself.

They all crap in the same sewers. That ought to bring them together.

All that amateur radio operators do is talk about the weather and describe their equipment. Those media are really ripe for infiltration.

We're starting with an incredibly powerful technology, and what we've got so far is an incredibly primitive technique.

There's a whole mass of information stirred in the computer. It's a filing cabinet that's so fast and so together that it makes a whole different kind of difference.

It takes 500 people to incorporate into a community. 30 is about the carrying capacity of most communes.

The guys I went to high school with are just about running the country now. I didn't get along with them. Nobody here did.

We gave everybody a spoon and the rule was you couldn't feed yourself.

At various times the situation has become very entropic. We seem to be taking the attitude this year that there are certain kinds of urgent things that need doing. . . . We have some 20 boarding students. All the staff are living at the place. If you want a place to live you better build it, and you better find out what the design considerations are.

It isn't enough to say I am a music teacher and my door is always open. We are going to do music at a certain hour on a certain day.

Yoga. Sociology. Math. Music. French. Biology. Literature—those happen to be the fields of competence of the staff who are there.

The changes that can come down in like 10 days are just real. There may have been a revolution while we're away.

The least active students right now are the new students. I guess it's right. They're going through shock.

What's our policy on drugs? "You're not free to get the school busted." It's the same with sex.

We don't know whether we're on a 5 year thing or a 500 year thing.

It's all show. It's the life show and the show show and we're trying to get them till they're all one.

In public high school I could sort of dig the idea of being a classroom Commando. But at Pacific it's obvious you're just fucking yourself.

The hospital is right next to the stage and the kitchen is next to that. And we put the light show on the girls washing dishes and with all that energy the dishes just wash themselves.

We called our group at first Bum Academy.

Entrance requirements: You must walk from Tokyo to north of Japan to south of Japan, with no money.

Preparing the student for "the Future". High school will prepare you for college. And college will prepare you for a job. And a job will prepare you for retirement. And retirement will prepare you for death. We call that "The Sorrowful Round." It's based on the present, not the future.

It's really far-out to look at a teacher as an overgrown student, and a friend.

The students ask to graduate. It's a privilege of the staff to decide. We huddle in a smoke filled room. We get the student in there. We have certain criteria which we hold up against the student:

3 quarters of presence (we've graduated some at less) is 18 years of age clear idea of what he wants to do

Tips on Galvanized Roofing and Siding

Here are tips from professionals to help you get the best service from galvanized steel roofing and siding. They're of value whether you do the job yourself or have it done.

Framing. Fasten purlins or nailing strips to rafters before nailing down galvanized steel sheets. When rafters are spaced on centers of 48 inches or less, you can lay 2- x 4-inch purlins flat. With rafters wider than 48 inches, place purlins on edge for greater support.

When putting steel sheets over an existing roof, install 1- x 3-inch nailing strips with extra-long nails through the old roof into the rafters. Space strips as you would purlins, making certain that there is a strip where metal sheets lap.

Nailing. For good holding power, use galvanized ring-shank or screw-shank nails with a lead or neoprene washer. Lengths of 2 or 2½ inches are best for this. They allow a 1¼-inch penetration into the wood.

Nail every third corrugation when working with 2½-inch corrugated steel sheets. With 1½-inch corrugated sheets, nail every fifth ridge.

Nailing at the top of corrugations on roof will direct water away from the nailhead and create a slight tension that increases holding power. (Nails can be driven into valleys on corrugated siding.) Never "overdrive" nails because it can damage sealing washers.

Handling side and end laps. For both roofing and siding, overlap one full corrugation at sides of sheets and overlap 6 inches at ends.

Extend roof sheets at least 3 inches beyond purlin at the eave for a drip edge. Siding sheets should overlap foundation or splash planks 2 to 4 inches.

Start on a left-hand corner of the building when installing siding. Work your way around the building, bending steel sheets around corners to ensure weather-tightness.

Getting started. Start the first sheet of roofing in a lower corner away from prevailing winds to make the roof more windproof. Be certain the first sheet is on course and then follow with additional sheets according to the diagram shown. Lay sheets across the eave first and then up the slope.

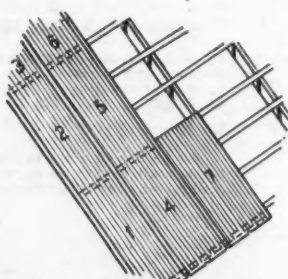

Start roofing in a lower corner.

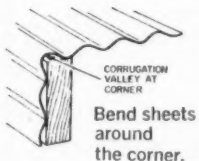

Battle of the giants

Last month I heard Abbie Hoffman at Stanford (doing an evening of fund-raising rap, sharing the stage with Scott Beach and Del Close of the Committee and Wavy Gravy.) His delivery reminded me so much of Herman Kahn's and Paul Ehrlich's that a debate came unpreventably to mind. They all are bastard sons of Lenny Bruce and each at the center of major issues. Next day I wrote this letter to the three of them.

Dear _____

This is a feasibility probe to determine your interest in being 1/3 of a public event:

HOW TO SAVE THE WORLD

Paul Ehrlich
Abbie Hoffman
Herman Kahn
(and Greek Chorus: The Committee)

Time: Spring 1970, Saturday Night.

Place: San Francisco Bay Area

Size: 3,000 — 10,000 audience; should be newsworthy.

Admission: \$3.

Profit: Split the net take 3 ways; send your surplus to the Cause of your choice. (If you want a minimum guaranteed, say so.)

Sponsorship: Portola Institute has front money (from Whole Earth Catalog), experience (Trips Festival, Whatever It Is, Liferaft Earth), and non-profit educational legitimacy.

Format: 3-way debate; as much audience participation as you're comfortable with.

We'll proceed with the event only if all three proposed participants are interested. All are being invited simultaneously. If you are interested, we need to start bracketting a date: what months/weeks are most possible for you next spring?

Yours for a world without end, amen,
Stewart Brand
WHOLE EARTH CATALOG

After a few weeks and prompting phone calls, they all had answered, and all wanted to do it. The most agreeable date was Monday night February 23. So, barring jail sentences and other hazards, that's when it will be. That's all we know at this moment.

Cutting. You can cut several sheets at a time by using a portable circular saw with a metal-cutting blade or a reversed cutting wood blade. Never use a rip blade. To do a neat job, clamp a board to three or four sheets as saw guide. Always wear goggles or safety glasses while cutting.

Bending around corners or gables. To get a smooth corner without special trim, line up a corrugation near the center so that the valley is right at the corner instead of starting the edge of the sheet at the corner. Nail the sheet to one wall, bend free half of the sheet around the corner, and nail.

Work toward either wall with the siding. When you are two sheets away from the next corner, measure to corner and adjust so that the valley of a corrugation is again right at the corner.

Sealing. Use flexible filler strips that are formed to fit corrugations. Place strips between foundation and siding, siding and plate, roofing and plate, ridge roll and roofing connections.

Lining up the siding. Measure a distance equal to length of siding from roof to foundation or skirtboards and mark it off with a nail on both corners. Stretch a chalkline between the two marks. Snap the chalkline and then tack a 2- x 4-inch board or other straight board at the line. Rest sheets of siding on the board as you nail them into place.

—Mike Creel.

The Progressive Farmer, Jan 70, \$2/yr (monthly), Box 2581, Birmingham, Ala. 35202. Magazine has five area editions.

Hangover-ade

According to Videa 1000 (\$15/yr (monthly), 54 Park Ave, NYC 10016), "highly reliable medical research indicates that the new 'quick energy drink'—Gatorade—is good for hangovers. Perhaps because it enters the bloodstream 12 times faster than water, which can soften the blow caused by dehydration and the chemical imbalances that ensue."

Business

The great mail hassle

We were having CATALOGs sent to subscribers 3rd Class mail, aptly named junk mail. Gradually we learned that delivery to the East Coast was taking up to six weeks, when delivery occurred at all. Subscribers were patient and amused, considering ("Got Catalog in January. Somewhere in transit the Post Office tried to see if it would float."), but we were getting desperate.

Our local post office pointed out that we qualified for Second Class mail privileges, which would give the much faster service that other periodicals get—more reliable too, maybe. So we applied and tried to explain that despite the name, we are not technically a catalog, not by Post Office rules, having to do with content, subscribers, advertising, newsstand sales, etc. — nor by commercial intent. We are a periodical, in spirit and letter.

The application came back. We asked why. "Catalogs go 3rd Class." "It's not," we said "a Catalog." "It says WHOLE EARTH CATALOG on the cover." "The Rolling Stone," said Dick Raymond, "is not a stone. We didn't know about Post Office classifications when we named our publication." "Catalogs go Third Class."

I was ready to burn a flag to the deity of General Semantics when Dick Raymond came up with a concept so original it took my breath away: call our Congressman, our representative in the Federal Government. Dick had worked on our Congressman's successful campaign; that might count for something.

It did. The gent who beat Shirley Temple Black, a Republican named Pete McCloskey, foe of the Vietnam War, friend of environmental issues, very capable cat, checked with the mail classifications office in D.C. and suggested we appeal our case to them. Meanwhile we would get "2nd Class Pending" service from Post Office.

With amazing speed our appeal came back from Washington, refused this time because sometimes the publication was titled "Supplement to the Whole Earth Catalog"—making it two publications, in their eyes, neither published often enough to qualify as a periodical.

Ever ready to compromise on empty issues, we re-applied with the explanation that "Supplement" had been dropped and we were publishing six Whole Earth Catalogs a year (as always), and like other magazines they would have varying sizes and prices at different times of the year. No answer as yet.

If we get the 2nd Class classification, mailing will cost a little less than 3rd Class, but we would gladly pay 3rd Class rates, or worse, if we could get 2nd Class service. When you have 6000-7000 subscribers, you give good service or you get crushed by bad karma. I wonder if the Post Office never feels that way about taxpayers.

The great Fall CATALOG mailing breakdown

Mailing Mart in San Francisco, who was to mail out the Fall CATALOG to subscribers, lost track of the 2,000 or so new subscribers since September and took nearly a month finding their addresses. We considered suing Mailing Mart for this lapse, but lost heart about prolonging the whole sickening affair, and instead mailed complimentary "Fool" posters (derived from Brown's Laws of Form) to all the injured subscribers and spent some time ensuring that they finally did get CATALOGs (cost about \$1000). We sincerely hope that Republic Corporation, our new mailing outfit in Burlingame, will do better.

Will the CATALOG sell out, and, if so, to whom?

Dunno yet. Last September we said we would cease publication in the Spring of '71 with a big Last Catalog, to be distributed by somebody big and good at it, like a New York publisher. Distribution in the meantime is being handled nationally by Book People in Berkeley (see next page).

Since our announcement we've been flattered by attention from Doubleday, Holt Rinehart, Grossman, others, and particularly Dutton, who was the only one to make a firm offer: \$6000 advance with a 10% royalty to 7500 copies, 15% thereafter. Because we would be doing much of the publisher's work, right up to page negatives, we're looking for a better offer.

We've heard so many rumors (including one from the *Christian Science Monitor*) that various people have the Last Catalog sewed up that we're tempted to start a few ourselves (I hear the Catalog has been bought by Walt Disney). One day we heard that the CATALOG was bankrupt and read in the paper that it was rolling in dough. All we know is that the first 60,000 Fall CATALOGs are sold out, and a new 100,000, with a better cover, have been printed. And we're paying off our original loan.

Production Costs

Total: \$6,039 (does not include research, mailing, shipping)
40,000 copies printed January 1970
Unit cost 15¢

\$1 Catalog production cost pie

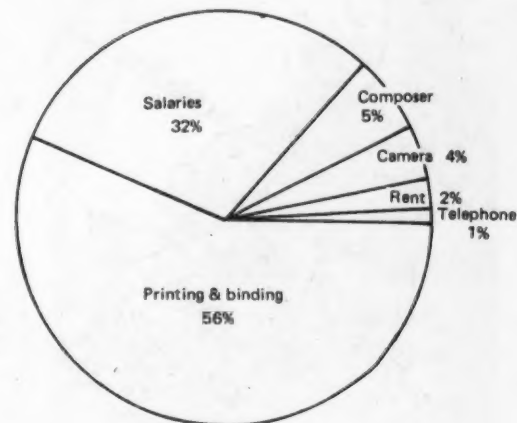

Suggestions for the WHOLE EARTH CATALOG

An item is listed in the CATALOG if it is deemed:

- 1) Useful as a tool,
- 2) Relevant to independent education,
- 3) High quality or low cost,
- 4) Easily available by mail.

Please fill in as much information as you possibly can; it helps a lot.

My name _____

Address _____

Date _____

Phone _____

I SUGGEST:

Title of book or name of item: _____

Author _____

Price _____

Publisher or Supplier _____

Address _____

If an item suggested is intended to replace an item already in the CATALOG, please fill in the item to be replaced:

I would like to write a review. _____

Attached is a review of this item. _____

I would recommend _____
(name, address, phone)
to review this item.

Additional information: _____

Whole Earth Truck Store

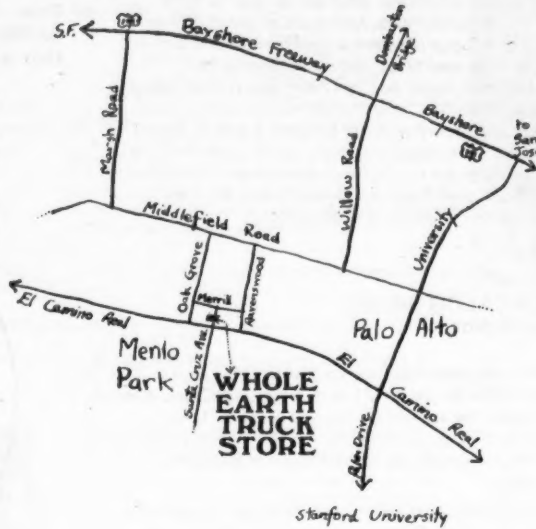
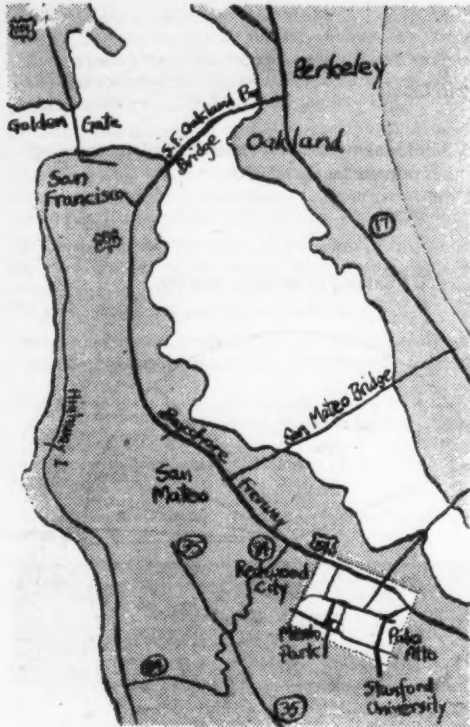

A major research source of ours is the Menlo Park Whole Earth Truck Store, which stocks most of the items in the CATALOG. We see who's buying what. We hear complaints and suggestions. We try out items that might be in the next CATALOG. We have a place where friends can come and see what's happening.

Hours: Monday-Friday, 9 am - 6 pm
Saturday, 10 am - 6 pm

558 Santa Cruz, Menlo Park, CA 94025

Phone: (415) 323-0313

Catalog Distribution

Book People, by agreement with the Bookworks, announces national distribution of

THE WHOLE EARTH CATALOG

The Whole Earth Catalog is published six times a year—2 large ones (Spring and Fall) and 4 smaller ones. As the materials are not completely duplicated, you can carry everything in print. Currently available:

- Spring CATALOG \$4
- July 1969 Supplement \$1
- September 1969 Supplement \$1
- Fall CATALOG \$4
- January \$1 Catalog

All retail, wholesale, and library distribution is processed through Book People; please do not direct your resale orders to Whole Earth Catalog Store.

TERMS:
All retail, wholesale, and library distribution is processed through Book People; please do not direct your order to Whole Earth Catalog Store.

TERMS:
Retail: 1-14 assorted 30%
15-up " 40%
Wholesale: 100 up assorted 50%
(qualification: meet the requirements of our certificate of wholesale endeavor)

Invoices are due net 10 EOM
Accounts 30 days overdue will not be shipped.
Credit accounts will be established through your Dun & Bradstreet rating, new businesses are advised to enclose their financial statement.
Returns: request label. Unauthorized returns will be discounted at a penalty.

NOTICE TO NEW ACCOUNTS:

For immediate shipment, please enclose check to cover order. Catalogs are \$4.00 retail for Fall and Spring issues, \$1.00 retail for the others (Jan, Mar, July, Sept.). Figure your discount. Allow one pound for each catalog or each seven supplements. Figure your freight charge at Book Post rate:

12¢ for first pound
6¢ each additional pound

Thank you,
BOOK PEOPLE
2010 Seventh Street
Berkeley, CA 94710

Phone: (415) 349-3033

Subscription Form

Send to: **WHOLE EARTH CATALOG**
Portola Institute
558 Santa Cruz
Menlo Park, California 94025

\$ _____ Amount enclosed.

\$ 4 One issue of CATALOG 1969 Fall 1969 Spring (The Fall 1968 CATALOG is no longer available.)

\$15 Five copies of current CATALOG

\$ 8 One year subscription: six CATALOGS, two large (Fall & Spring) and four smaller.

U.S. and Canada starting 19__ Fall CATALOG 19__ Jan. \$1 Catalog 19__ March \$1 Catalog
\$9 surface elsewhere; 19__ Spring CATALOG 19__ July \$1 Catalog 19__ Sept. \$1 Catalog
\$14.60 air elsewhere.

\$ 25 One year Retaining Subscription

\$100 One year Sustaining Subscription

ZIP

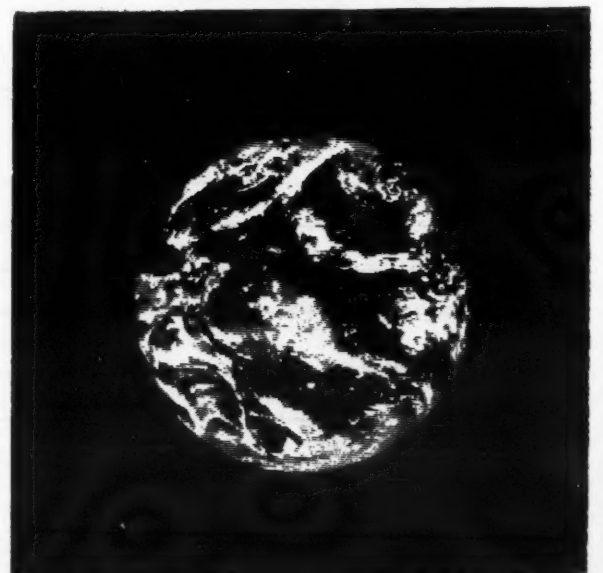



PORTOLA INSTITUTE

INC.
1115 MERRILL ST.
MENLO PARK,
CALIFORNIA
323-5155

Music Studies Program

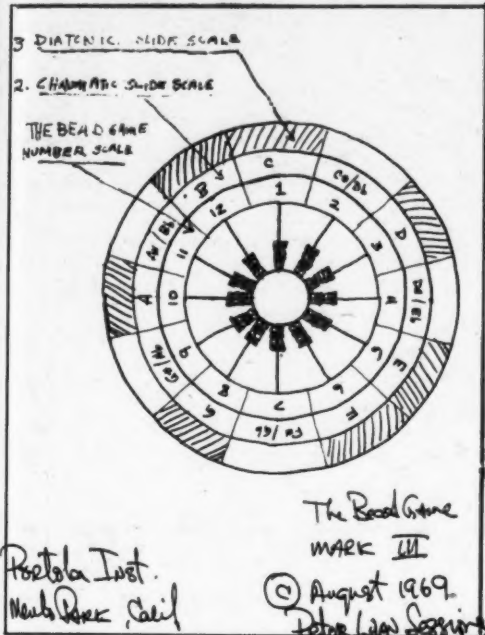

The Bead Game: a composition system

The Whole Earth Catalog is one division of PORTOLA INSTITUTE, INC. Other present activities of the Institute include



Ortega Park Teachers Laboratory



High school underground newspaper meeting at Scripps.

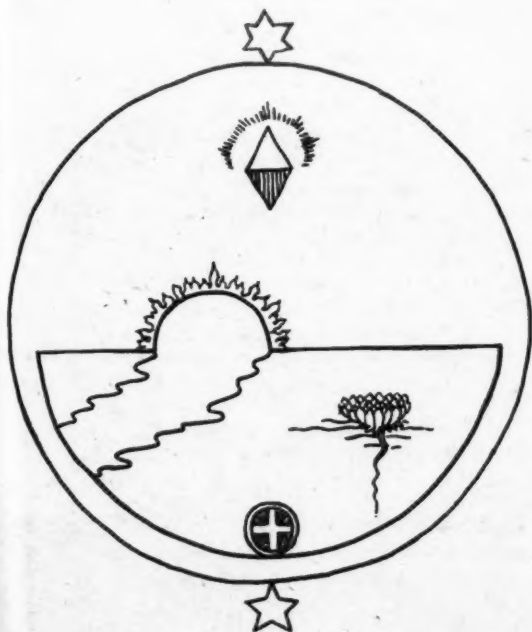

Scripps Off Campus Project Center



Two posters for recent meetings at Ortega Park.

PORTOLA INSTITUTE was established in 1966 as a nonprofit corporation to encourage, organize, and conduct innovative educational projects. The Institute relies for support on private foundations and public agencies, to whom specific project proposals are submitted.

Because Portola Institute is a private organization with no need to produce profits or guarantee "success", it can experiment with new and unusual educational projects that would be difficult to administer within more structured organizations. For this reason the staff and facilities of the Institute are deliberately kept small and flexible.

Within its framework a wide variety of projects dealing with innovative education can be created as people with ideas are able to interest people with funds. New projects are always being considered, both within the existing divisions and programs, and within as yet unexplored realms of the learning experience.

Portola Institute, Inc.
1115 Merrill Street
Menlo Park, CA
94025

More information on Portola Institute, please. Especially _____

zip

WHOLE EARTH CATALOG
558 Santa Cruz Avenue
Menlo Park, CA 94025

SECOND CLASS
PERMIT PENDING
MENLO PARK, CA



Guy alone sharpens a spoon alone. Stripe of light on the stone floor traverses because it is sunlight from the slot of light up the hinge side of the door. Leather hinges, wooden door, log walls. The door must be locked from outside. Say it's a trap (he does).

There's a fragment of mirror (okay?) jammed in the logs opposite the door. Say meals and water and such are taken care of, no explanation. The spoon goes with the food. The guy says he's sharpening the handle end of the spoon so he can cut the food better. On the stone floor he scrapes assiduously so the spoon will have an edge to cut his food better.

The work goes better rhythmically, so he hums with the scraping. Two sounds, humming and metal, got them? And the guy crouched over his work.

Dust seethes in the bar of light from the doorcrack. Sun comes in from what outside? (Many times, any time, he has looked through the crack, registered bright grass and bugs and rustlings, meadow in fact, and visible far line of forest. Forested hills, mountain high horizon, sky, cloud code, sun . . . mostly it's nothing to him. Sometimes heartbeat rears up within him and connects with what he cannot grasp and he flays the stubborn door or his incessant chest, indifferent targets, same rage.)

Stripe of light proceeds—daypass—toward the humming busy back. Stonebright bar of light, bent back, rocking, stone dust; and the two sounds. You should know the spoon has been sharp since yesterday.

Superimpose yesterday. The rocking back came to a halt yesterday, halted forward pressing the spoon too hard into the rock. And the sound of the scraping

was replaced by the deliberate beat of human skull against rock—against knowledge: NOT FOR THE FOOD. Try it: pain goes to flash goes to blank.

(Later yesterday.) He woke up with a headache and a giggle, and hustled to the mirror to see what a giggle looked like. Saw bearded grumpy face; laughed further with shaking head. (Try this.) The shaking reflected face had eyes which did not move with the face. Instead they opened like mouths. During the madness that ensued he bit himself in the arm and acquired a dangerous taste.

So, for this day's work the spoon has become no sharper, merely less spoon. Skill has increased. Despite his wounded arm, the guy is moving ever more precisely, taking ever more care with the delicate blade in his hands.

The humming and metal scraping, a universe of that. Then in a fresh test of the edge he leans back, and the bar of sunlight falls dazzling on the blade. New universe.

What isn't blade and hand is dark. He doesn't move, just waits for the newness to become familiar (Not for the food). It's quiet.

Then he goes to the door, kneels there by the crack, checks on what's outside (meadow, sun), and resumes waiting. Heartbeat up, gradually up.

Leather hinge or incessant heart, either can be cut by a knife, friends. Do you know which is which?

[The ending I like is: he works on up to frenzy, goes abruptly clear, stabs the spoon into the door, stands up into calmness, matter of factly walks over and gets the always sharp mirror fragment, and cuts the hinges with that. The open door and the mirror and the sun make a configuration I leave you with.]