

decoding the hive

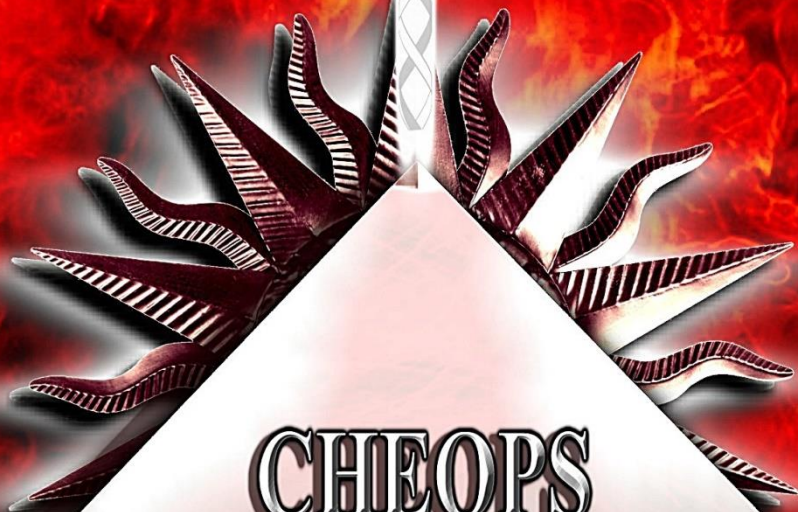

CHEOPS
SPOKE

GLOBAL COLD FUSION
ENERGY TEMPLE NETWORK

Pt. 1

HUMAN HANDBOOK VOL 5

CHEOPS
SPOKE
Pt. 1

DECODING THE HIVE

VOL. 5

HUMAN HANDBOOK SERIES
Cheops SPOKE Pt 1

By: mission guide
inventor, writer, empirical physicist

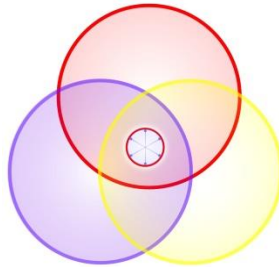

Illustrations original and sourced from public domain under
Fair Use laws for educational purposes

2nd Edition - Copyright 2019 - all rights reserved

1 2 19 19

Forward

-decodingthehive.info

Forward

The information shared in this human handbook series is not for everyone, and certainly not for the faint of heart. Life -a material concept- is a journey that each one takes as guided by their higher self. It is not to be mimicked or patterned after someone else's version of what is perfection. Perfection is eternally illusive and eternally the goal within manifestation. **All things** lead us to this ultimate destiny that every fractal of god seeks:

Balance within every single moment.

It is a perspective. Something relative to you and who you have chosen to be. This minute. This day. This life. Some may choose to play the protagonist this time, because last time they were the antagonist and it left a bad taste in their mouth. But you would have no idea whether or not you simply do not resonate with playing the role of the villain until you have played the role of the villain. And neither will your best friend, or your mom or dad. In the end, whether you set out to be the good guy or the bad guy, you will wind up playing both roles during your current life whether you planned to or not. That's because life is a barter every single day and with every single choice. You really would have liked to have: (fill in the blank here), but... **But** since the perfect option wasn't available this time, you choose red apples instead of green. Which leads to the next barter.

Forward

Ebb and flow.

And so goes the many epics that will play out in your journey, encapsulated within that one summer or that one life where you became a sociology professor instead of an architect. You may dislike everyone around you who “isn’t into” what you are into at this one time in your life, but at some point over your incredibly vast journey, you surrounded yourself with only architects for a time, or drug dealers or airline pilots until you had your fill and then moved on to psychology or a thousand -million- other fields of interest.

Within each compartment of time, you will always find something to learn and grow from, regardless if that is your first choice in filling that space in your life or not. Just like you learned important principles about philosophy while you were building a shed or planting a garden; things that you would never expect to learn all alone in your backyard.

Balance is where you are able to be exactly who you are in any situation, whether you are repairing a fence, driving a tow truck or designing a skyscraper. It is all things at all times which translates into contentment regardless of where you are or what you’re doing. Do not make the mistake that just because you had an opinion that you were actually living that moment. Unless your actions (initiative, response or inspiration) comes from inside of yourself

Forward

alone, and not from *what would dad do*, or *what would someone else do*, or *what do others around me expect me to do*, then that was simply put, not an authentic moment of your life, because *only from within* comes authenticity and only from authenticity comes balance.

And the word authentic now comes front and center to your life; where you understand that every fractal of god came into being for one purpose; to be their authentic self. By allowing someone else to influence your initiatives or responses, you are now parroting someone else's authorship.

Daddy isn't going to be there every minute of your life. Neither will mom or sis or bbf. But you will.

You will never find you unless you choose to author that unique being into existence.

Now you have found yourself facing the ultimate challenge: to learn things that will absolutely make you uncomfortable, and test your will to learn more, reach higher and ask from your mind to process what the everyday person will never have the courage to face. The real truth. But in doing so, you know that you will become a better painter, architect, personal assistant, plumber, philosopher and every single thing that you will be before your journey ends.

Forward

By following the beat of your own drum that only you can hear, you are listening to your higher-self offering you guidance on your journey to discover your one signature within the billions of parrots and mimes that make up your world. In that quest, you suddenly become the real you that you have been looking for all along; the one unique expression of life that is the very best version of your mother's son or your father's daughter that could possibly be.

You are not perfect, because there is **no such thing**. When you get mad, that is just you expressing to the world around you that you have not yet reached the point where you are ready to end your quest to “perfect” the forge you wish to leave upon creation. With each damnitsonofabitch, you are allowing another moment to pass where your higher self was telling you *here is that apple of gold you have been asking for, don't miss it*. Do not confuse this lesson as just another bad day where everything went wrong, because it isn't that. This is you learning how to be balanced even as the raft careened into the wrong channel down the rapids. That is just a new journey on your way to you.

You may not be driven to seek your signature through fortune or fame. You may not be driven by merely wanting bigger, better, faster for you and yours. But regardless of what drives you, the one thing that no one who ever lived wanted to leave behind them as their stamp on the world

Forward

once they finally said goodbye was; “**Here Lies Johnny. He Accomplished Nothing.**”

Balance doesn't have to be big and bold, but it *is* self-aware and self-secure. It needs no one to complete itself but you and you alone. Only then will you ever be the perfect friend. Wife. Mother. Dad or brother. The one that always lights up a room because you are not there to place your shortcomings onto anyone else at the party. Your smile comes from knowing that this will be your moment to learn something you didn't know before. And it might be in the form of learning patience mending from a broken leg, or surprising yourself that you really could build that bridge all alone. It might be something as simple as feeling good about yourself just because you helped an ant get up that hill he wasn't going to make all on his own. When you can do that, you know that you are nearing your elusive goal of harmonizing with all things.

These are the moments where you become the *higher* version of the son or daughter mom and dad never thought they would ever meet. The moment where you begin to truly shine because you were willing to do what no one around you was willing to do: to become someone who isn't afraid to learn that nothing up until this time you have ever learned had been the truth, and you were willing to learn that lesson so that your next moment will be better than your last.

Forward

“Tomorrow” is not *the end of your journey*.

It is merely the next step you will take in a never-ending series of steps that define exactly who you really are. So do not make the mistake of thinking that “tomorrow everything will be absolutely perfect” if you *just do this*. Or you summon the will to *do that* in preparation. But it *can be* better. And better is the one constant that balance seeks, regardless, because **this** moment is forever the **last** moment in that **tomorrow doesn’t really exist**. You are “only as good as your last hit” as they say, so make certain this one was your final stamp - your message you leave behind for all to see - because it will be your epitaph should this be your final farewell.

If there has been one thing I have learned from living with council members of a faraway and advanced “fraternity” as they refer to themselves, over the last year, it has been this; to face each second with the same grace and verve as you would on your way to the most elegant affair, undaunted by what may lie ahead. Because the rain cloud overhead may just bring the most dazzling rainbow you will ever see. And that will be the best moment. Not tomorrow, not next year, but right now, this moment.

The easy path to get there is rarely, if ever, the high road. The one well-worn is the one taken by those who merely follow. Leaders aren’t born following, they are born questioning. The wise take the one not just less traveled,

Forward

but the one that simply doesn't exist until they bring it into existence.

Swords never sharpen by eviscerating strawberries. They sharpen from moving between rocks and hard places.

You are about to test the steel of your sword now, and face the challenge of learning the language of tomorrow where you will no longer be dwelling in caves and scavenging food and fire. The long cycle of your evolution for this phase of your journey is now over, only if you are truly ready for the next level. Those around you are choosing their own authentic paths, so do not be fearful or worried for them if they are not right by your side during this transition, because they will be exactly where they are supposed to be in their never-ending quest to balance, just like you are.

And how does this answer a single question you have about the pyramids? That should be obvious. You have chosen to enter a field beyond quicksand just by posing the question in your mind that the mountains made out of stone from the ancient past could really have been more than just oversized tombs for oversized egos. Where the answers you now learn will almost assuredly put you even further out of favor with your peers than you already were. Yet you came anyway.

Forward

There are few who will actually break through the barrier between what they have been led to believe all their lives about energy, and learn the language of Interdimensional Scalar Vibrational Mechanics that lies within these pages. The mountains of stone that lie before you on your journey are about to teach you something no one else has bothered to mention until now, and it is up to you to dig down and find that untapped vault inside of you that was written into the very codes of your DNA long before you arrived at this divide to conquer them. It is called your cellular language imprint held in each of your cells where this lexicon truly lies and is merely up to you to remember it now.

You have been handed an artificial reality, so the ground you stand on is not actually real in the sense you think it is. As long as that is the case, one will never find balance.

This is your summit to scale now, as the rope is already right there in your hands. Up there you will find yourself one step closer to balance just by finally learning the truth about how energy really works within a holographic reality created entirely by the sparks produced by thought alone.

-mission guide

Reader Notes

On decodingthehive.info website you will find various companion articles appearing and disappearing as council wishes. You are required to visit this site often and to push yourself to recognize the applicability of the esoteric to the mundane of the everyday.

This report will occasionally be quoting some text from Wikipedia, which is a known Kybal disinformation platform. The only time it is quoted here is when the information has been independently researched from other reliable sources first to determine these to be the most accurate details available in condensed form for the reader's benefit. Do not confuse these selections as a blanket endorsement of that or any other platform. Always cross verify any details you find there or anywhere else.

Wikipedia has many facts relatively correct as far as current scholars agree to be accurate on otherwise random subjects to the researcher, backed up by laboratory results and multiple sources from across the spectrum. In those cases when I already know the report to be accurate within the scope of what is accessible, I will share that information with you as a starting point for your own frame of reference. Much of the data contained therein, if not most, is not "the whole story", since we already know that the most important facts have been deliberately withheld for various reasons that have to do with greed and

Reader Notes

domination. This report is a synopsis only. It is the responsibility of the reader to verify all facts across all available sources for its greatest accuracy.

All subject matter included in this disclosure has been researched extensively and in some cases continually for years before these truths could be spoken. The accuracy of the statements made herein are within the limitations of the feeble power of the human mind to parse. If you find any details outlined that are inaccurate or misstated, please contact me so they may be corrected. This is an evolving body of work. I do not claim to possess all the facts, nor understand all sides to every story. I do claim that the technology presented herein has been vetted for accuracy to the very best of my ability to be factual in order to minimize your journey to the real truths that have been obfuscated for so long.

This disclosure is written under a pseudonym in the event something should end my ability to continue. It will not be the name of the writer, but the voice itself coming through that you will want to continue to seek over the course of your journey for further instruction and clarity. I did not coin the phrase to not follow a man, but follow the message. Faces and names mean nothing; actions do. We have already had many of our team members fall in the course of this mission which could happen again.

Reader Notes

If this voice suddenly goes silent, you will seek these same words as offered by the next soldier in line who will just tell you straight what it is you are up against, and will not couch that in soft fluffy terms to pander to your sensitive feelings. There is no time left for games, as this ascension window is already coming to a close.

Like J. K. Rowling, Mark Twain or Agatha Christie, I write under a pen name that has had to change more than once in order to continue to offer what I am tasked to share with you. I am not here to kid anyone, but merely wish to remain alive so I can continue serving my mission. Anyone who thinks it is easy to inform people they have been misled, just try it sometime for yourself to see the unequalled backlash that comes from even the closest ones around you. If you need to address me, then just call me mission guide for now.

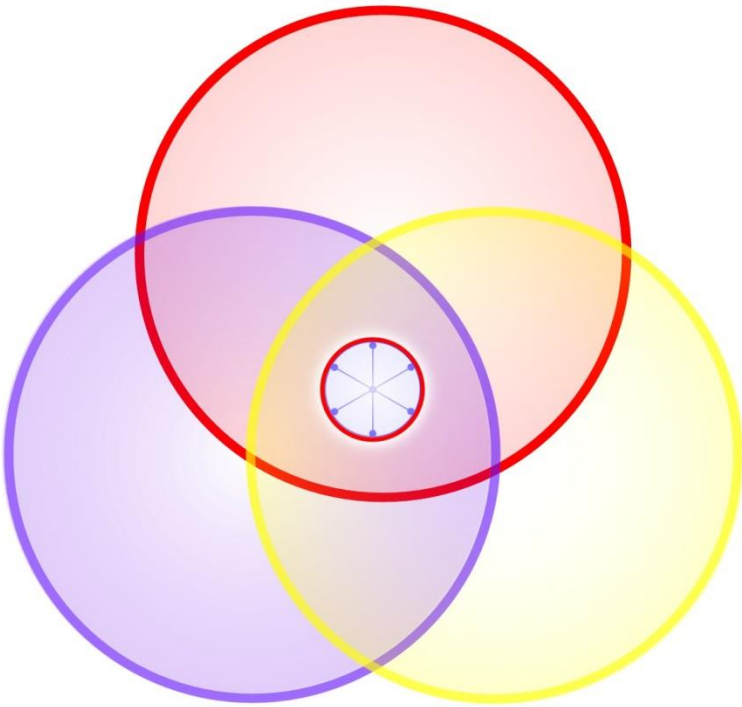

Table of Contents

Cheops SPOKE Pt 1

<i>FORWARD</i>	III
<i>READER NOTES</i>	XI
TABLE OF CONTENTS CHEOPS SPOKE Pt 1	XVI
CHAPTER 1 ELECTRICITY IN THE ANCIENT PAST	1
DENDERA LIGHTS	3
CHAPTER 2 ARCHITECTS OF THE PYRAMIDS..	11
MEGALITHS	15
PERSPECTIVE	17
THERMONUCLEAR WAR	19
CHAPTER 3 GEOPOLYMER SILICON RESIN.....	37
PRINTS IN THE STONE	38
DUPLICATED PATTERNS IN STONE	62
FRANK LLOYD WRIGHT	67
CHAPTER 4 THE HIDDEN EYE OF HORUS.....	73
DARK MATTER DEVICE	74
SPECTOGRAPHY	79
CAPSTONES	85
RA, OSIRIS AND HORUS	93
CHAPTER 5 ELECTRICAL ENERGY	98
DISTRIBUTED ENERGY RESOURCES	99
INVISIBLE ENERGY WAVES	101
IONS AND STATIC ELECTRICITY	105
CONDUCTORS AND DIELECTRIC INSULATION	105
POLYMORPHS	108
ELECTRICAL CURRENT	110

Cheops SPOKE Pt 1

PHOTOELECTRIC FIELD VS ELECTROMAGNETIC FIELD	112
ELECTROMAGNETIC INDUCTION	117
ELECTROSTATIC INDUCTION	119
SECONDARY EMISSIONS	125
STATIC ELECTRICITY AND NEUTRINOS	131
THE GOD OF WATER	138
STATIC ELECTRICITY AND NEUTRINOS CONT.	140
CATIONS AND ANIONS	144
CRYSTAL PHOTOVOLTAICS	147
CHAPTER 6 DARK MATTER ENERGY	151
RADIATION	153
IONIZATION VS IONIZING RADIATION	157
REDOX METAL	164
AQUALUNG	166
REDOX METAL CONT.	169
SEMICONDUCTORS OF DARK MATTER	174
URTH BATTERIES	190
BLACK BODY RADIATION	192
NANITES	195
DARK MATTER ENERGY DISTRIBUTION GRID	199
IONIZING EMF EMISSIONS FACTS	215
RADON URAH	216
ELECTRICITY EXPLAINED IN TWO MINUTES	217
RADON URAH CONT.	219
SCALAR WAVES (THF)	222
CHAPTER 7 SECRETS OF THE STONE	224
APERIODIC SCALAR OPTICAL WAVE FIELDS	228
PYRAMIDION INSULATOR	229
CRYSTAL VALENCE BANDS	233
PYRAMIDION INSULATOR CONT.	234
WINGED SOLAR DISC	240
TERAHERTZ TIME-GRATED SPECTROSCOPIC IMAGING	263
CHAPTER 8 SCIENCE OF THE STONE	267
NEODYMIUM	270
QUANTUM LOCKING LEVITATION	280

Cheops SPOKE Pt 1

MAGNETITE LEVITATION	281
LESTER’S COME TO JESUS MEETING.....	283
SUPERCONDUCTORS 1, MAGNETIC FIELDS	294
SUPERCONDUCTORS 2, THE MEISSNER EFFECT	297
SUPERCONDUCTOR 3, GRAPHENE	299
SUPERCONDUCTORS 4, PARAMAGNETISM	301
SUPERCONDUCTORS 5, COOPER PAIRS.....	306
666	312
SUPERCONDUCTORS 5, COOPER PAIRS CONT.	315
PLASMA BODY	315
SUPERCONDUCTORS 5, COOPER PAIRS CONT.	317
CHAPTER 9 “MFKZT” - THE PHILOSOPHER’S STONE.....	318
MONOATOMIC GOLD	320
ORME/ORMUS MONOATOMIC GOLD	323
PIXIE DUST	328
ORME/ORMUS MONOATOMIC GOLD CONT.....	329
KIRLIAN SPECTROGRAPHY	330
QUARTZ; NO HALF-LIFE.....	333
KIRLIAN SPECTROGRAPHY CONT.....	334
PHOTORADIONIC ENERGY.....	335
SASER ULTRASONIC RESONANCE LEVITATION	337
TORUS FIELD.....	341
RADIATION FATALITY PANDEMIC	343
CHAPTER 10 SUPERFLUID HYDRODYNAMICS	349
LEVIMOON® LEVITATION.....	353
AEROPLANE LEVITATION	355
BISMUTH THE ALIEN CRYSTAL	373
CHAPTER 11 ULTRASONIC AIRBORNE LEVITATION.....	393

CHAPTER 1

ELECTRICITY IN THE ANCIENT PAST

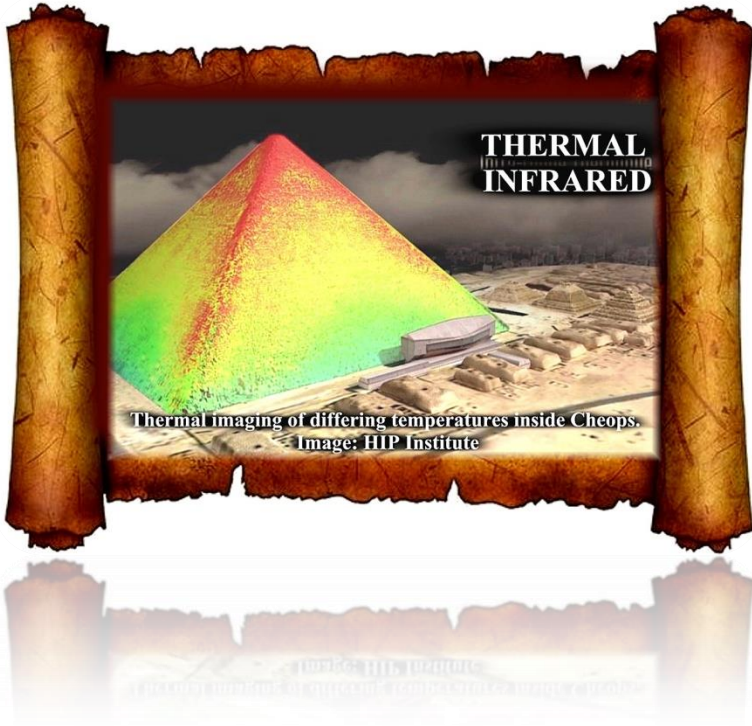

The *sharp edges* of the pyramid of Cheops shown above are many times warmer than the flat, planar surfaces a few feet away as clearly depicted in this infrared thermal imaging. They are also much warmer where they come together at all four tapered points even yet. Why? Is this because they are closer to the sun reported erroneously to be *150 million kilometers* away? Really? Yet this is exactly what science would have you believe.

Cheops SPOKE Pt 1

Just to put that into perspective, this would be comparable to your taking a single step closer to a camp fire located on the other side of the world and having to remove your jacket. In other words, once you apply any logic, reason or math to the official narrative from science, suddenly the absurdity becomes so overwhelming there are simply no words within our lexicon that could ever describe how preposterous these notions really are. You are looking at the physical evidence before your very eyes that *light waves themselves are moving energy*, and that heat you sense is not from some *radiant ball of fire from outer space*.

Those waves interact with certain shapes and surfaces differently than others, due to the unspoken true laws of physics no one has ever bothered to mention until now. This is not science I share with you; this is **Interdimensional Scalar Vibrational Mechanics** that was used originally to create the world you are standing in. The *mechanics* of sound. **In the beginning was the WORD.**

Pyramids supplied the entire world with electricity at different times in history. I cannot tell you exactly how they were originally constructed, whether solely by megalithic stones or a combination of stones and poured forms. I can however tell you they were reconstructed using poured (liquefied) crystal, not by thousands of slaves pulling on ropes to move stone blocks carved by bronze hand tools and weighing an average of 5000 pounds apiece

ELECTRICITY IN THE ANCIENT PAST

with some as much as *80 tons* fitting magically together without so much as a single razor-blade's thickness between them. That isn't even something man can do today. I will show you how this was done, how they worked and can work again.

While the ones who rebuilt the energy temples in Giza were not quite up to the technological point of the original ancient builders who installed them to begin with, they still had knowledge. Lots of it. The only ones trotting around in ox carts were slaves, not those who held back the secrets of technology. Those *who from the heavens came* did not arrive on the backs of flying turtles.

DENDERA LIGHTS

The fact that Egyptians had electricity has long since been established by many different archaeoscientists down through history, reconstructing the very lights and power source found in the reliefs of the 4000+ yr-old *Hathor Temple* in Dendera Egypt by Austrian engineer *Walter Garn*:

Cheops SPOKE Pt 1



In fact, we didn't just find the reliefs of such technologies; we have actually found some of the devices themselves. The 2400 yr-old *Baghdad Battery* uncovered in Khujut Rabu, Iraq for instance:



ELECTRICITY IN THE ANCIENT PAST

The working model shown below, surrounded by multiple Baghdad Batteries which were found all across what was once known as Babylon which have been shown to factually work with nothing more than water and salt inside (further covered in decoding the hive, vols 1-4 -referred to herein as DTH-). The special documentary made on the Dendera Lights and Baghdad Battery was aired in September of 1996 on ABC titled *Chariots of the Gods? The Mysteries Continue*:



This model is now on display at *Jungfrau Park*, Switzerland:

Cheops SPOKE Pt 1



This was not the only relief of lights found at Dendera, Egypt. Below is a carving of even more; this time found in the *Temple of Isis*:

ELECTRICITY IN THE ANCIENT PAST



From the same complex, here is Isis wearing a light on her head, with bulbs behind and in front of her (with a human holding one up). Notice the two closest lamps to Isis have the same symbol for electricity sparking from their bases as used today. This symbol has some of the most complex, and ancient roots of any symbol still in use which stood for the power of electromagnetic energy as embodied in the ultimate god of the lower-plane (Urth), known as *Wawwu*:



Cheops SPOKE Pt 1

The fact is, it has been a very long time since man last knew about electricity and advanced engineering, so what is left for us today are merely remnants of such devices that were typically entirely stone that would hold up to the millennia of time, or metal remains that had been for one reason or the other, protected from the elements. There is no question that the Egyptians had time crafts, planes, submarines, helicopters, and even hovercrafts as seen in the unmistakable reliefs seen at the ancient city of *Abydos* in Egypt:

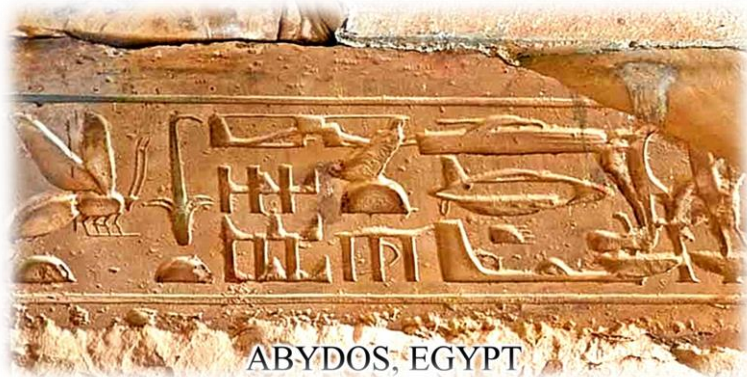

You will find out later in this report why the insects at the far left of this relief on the ceiling of the temple were included with Energy Temples and the other extremely advanced technologies of the ancient world when we get to the **Predator Drones** section ahead. These devices left over from that time that had been stored in caves and buried beneath ground have virtually all been scuttled off to the miles of antiquities now inventoried below the Vatican

ELECTRICITY IN THE ANCIENT PAST

and the Smithsonian Institute. Those left to the sun and rain were long since reduced to merely minerals absorbed back into the ground today. However, as you have already seen, there are some pieces and parts left remaining. Some thousands, others many, many millions of years old.

Such overwhelming evidence however, is still denied by accepted archeological societies as if these artifacts, megaliths and reliefs made themselves, because their own now-significant findings and hypothesis they make their livings from would be threatened otherwise. See for yourself; do a web search on scientific results showing conclusively that ancient civilizations possessed technology that we are still many years from reaching even now in the 21st century, and see what you find.

You will find tens of thousands of reports from around the world with rock-solid evidence and laboratory results to back up their findings. And immediately below those article results will be another one written by someone working directly for the Kybal, claiming that crazy fringe-science theory has been “debunked”.

They love the word debunked, as it presupposes that the topic was a theory rather than documented, scientifically-provable fact. This is to make you believe that the issue was already put to bed long before you arrived, so why waste your time on research when Dr. Cletus Shinplasters has already brought his undeniable credentials to the table

Cheops SPOKE Pt 1

on the issue to disprove it, and unless you spend the next 6 years in college and another 20 in the lab to prove him wrong, your voice will never be heard on the matter anyway. What they don't show in these debunking parties is any proof that the methods used to establish the report had been anything other than accepted, modern forensic equipment using established formulae, as applied by fully qualified research analysts.

Virtually everything presented herein will come with multiple references that can be independently vetted for authentication, but along with those, such as who built the pyramids which we cover next, can't. This is because such claims are simply impossible to prove without direct evidence associated with the claim. In this case, I will just have to accept the arguments that are surely to come from the paid-disinformation teams of the Kybal. However, once this body of work has been faithfully covered and researched, it should become more than obvious that this is not just another collection of theoretical postulations.

The very real beings who look over the safety of the structure called Cheops and have telepathically communicated this knowledge to me intend to make their points without leaving much room for speculation. Humanity has asked these questions for eons of time through countless civilizations. Now is the time to reveal the answers.

CHAPTER 2

ARCHITECTS OF THE PYRAMIDS



It has been debated likely as much as the existence of god himself; *who built the pyramids?* And more specifically, who built the *Great Pyramid*, the only standing example of the Seven Ancient Wonders of the World. Possibly hundreds of thousands of papers have now been written about Cheops and other ancient pyramids, each with their own speculation about how and why they were built. The theories range from simple observances to the most outlandish nonsense anyone could fathom. I know, I have read many of them until I thought my eyes started bleeding.

Cheops SPOKE Pt 1

Theories abound from the Egyptians having built pyramids for royal tombs or grain silos to ancient alien megalithic builders of flying space crafts, credited for building temples and structures with individual stones weighing as much as *4000 tons*. It has already been admitted by leading engineers that mankind today would have no possible way of cutting and placing such stones, much less create sculptures out of them with the flawless precision of optical laser surgery. While it may be conceivable that we could construct something on the order of Cheops (the Great Pyramid of Khufu), no one is stepping up and making the offer to prove it. If they ever do, it would be nice to include the features that the original pyramids actually used as described in this report.

It will take *27 pages* at the very end of this report just to explain in the most condensed terms all the steps Cheops will take before producing energy, only after I have spent the previous *700 pages* explaining the science of *each one*. I recommend you not make the mistake of reading that ending before going through every page leading up to it, otherwise none of it will make any sense. This is not the science you learned in high school and college. Nearly all of it is black ops technology not even your professor is actually familiar with.

There are over 100 pyramids in Egypt alone, and *tens of thousands* of others around the world (most now buried and look like mere mountains or at the bottom of the ocean).

ARCHITECTS OF THE PYRAMIDS

Many thousands have already been identified and documented, just not reported.

Down through all records in every form left for us to review today, not one civilization has ever depicted the building of any pyramid. *Ever*. Any civilization with the ability to create something of such awe and wonder would never allow history to ever forget that they had achieved such a marvel - leaving hieroglyphs, papyri, gold sculptures and statues behind showing how they managed such a feat. And their descendants today would still be dancing and singing in the streets while emulating the act every year in a festival in their own honor.

Sure, there are recent stories of how the slaves spent decades “building” pyramids, and how they had to escape from pyramid-construction bondage, but no civilization other than ancient Sumerians alone have ever come right out and laid claim to actually engineering and then building them. They were lying then, just as they are still lying now. Since their ancestry has been hidden from humankind, “Sumerians” or “Babylonians” are considered myths today, so these claims have no record in scientific history and no one is dancing in the streets wearing foam pyramid hats.

The *Global Cold Fusion Energy Temple Network* was originally built by *Lionine Blues* from Sirius B -who were master energy craftsmen- in **44,459 B.C.** as a gift to the *3rd Seeding* of the *Angelic Humans* under the *Co-Evolution*

Cheops SPOKE Pt 1

BioRegenesis Treaty of Palaidor (which promised ascension for every human and human hybrid race interested on planet). At this time, the creators of the Angelic Human project -the *Oraphim Angelics* of Sirius-B-, and the *Jehovah Anunnaki* (previously invader race) and most of their various legions, were working together under the BioRegenesis Treaty at that time in history.

The *Leviathan Drakonians* and their hybrids abstained from the ascension treaty, as did various other smaller renegade factions of invader races who simply chose not to support the ascension process from this *15 Level Time Matrix of Gaia*. It is the latter who remain in defiance of this project, referring to themselves collectively as the *Luciferian Resistance*. You know them as the Kybal, Illuminati, black-ops and the deep state.

Before you choose to dismiss the Illuminati as something of my imagination, here is a quick look at their official logo from their site which makes it clear they are not a joke at illuminatiofficial.org. We'll talk about their all-seeing eye soon:

ARCHITECTS OF THE PYRAMIDS



Almost 40,000 years later, the network was badly damaged, and Cheops and the Sphinx lay in waste from photoradionic pure-energy war by **5,546 B.C.** when restoration once began by the Sumerian invaders that immediately went on to rule Egypt.

Cheops was restored at the hands of human workers, and the badly damaged face of the Sphinx was replaced by the now much-more human-looking hybrids ruling over the lands of Babylon and Egypt. The Lionine face that was hewn off was one of the original Anunnaki who had offered the Ultrasonic Energy Grid to the new iteration of the human experiment. The restoration took place using different techniques than first employed to erect the Great Pyramid which we are getting to in this paper.

MEGALITHS

Cheops SPOKE Pt 1

Before we go any further, it would be a good time to cover some of the very recent beings who *have* actually laid claim to the creation of the pyramids. The “Sumerians” not recognized in mainstream history. It is amazing we have the ability to include words written on paper as irrefutable, canonized fact regarding our history, and toss out gigantic monolithic creations of unspeakable design and technology as if it were something out of a Disney movie.

I hate to break it to you, but the 1.9 million-year-old, mountain-sized castle at Mount Shoria in southern Siberia, built with **4,000-ton stone blocks** isn't a myth, no matter how much your history teacher would like to make you believe it isn't really there. These stones are literally bigger than full-grown evergreen trees. The structure is over 13 stories high and more than *a tenth of a mile long*:

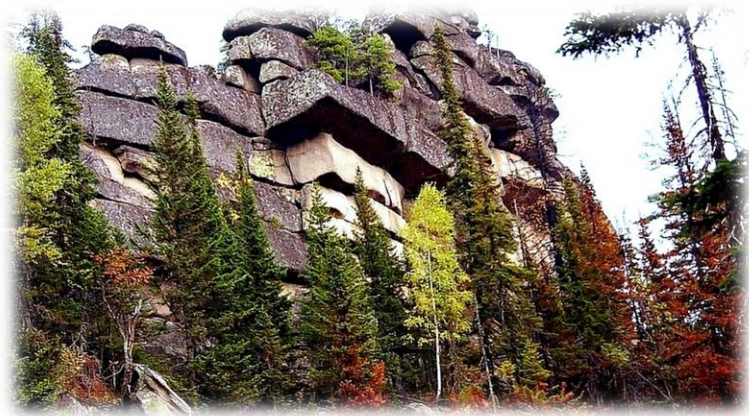

ARCHITECTS OF THE PYRAMIDS

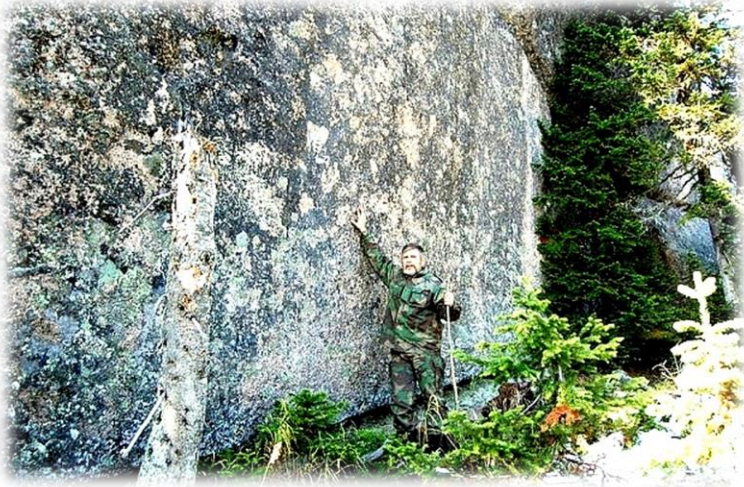

PERSPECTIVE

One ton is 2000 pounds. This **single stone** shown above from this megalithic build weighs 4000 tons (8 million pounds), or *twenty times* as many as all the automobiles in the photograph below, roughly the same as *twenty six hundred cars*:

Cheops SPOKE Pt 1



That is a line of cars pressed bumper-to-bumper for 6.9 miles long, over **11 kilometers**, and we are to believe that they cut these using bronze axes then moved them using ropes and pulleys **13 stories high**, over **40 meters** in the air. I am not done yet. This is the same weight as **fifty eight thousand people**, meaning it would take around **100,000 people** just to move this stone **one inch**, pulling on a rope that would weigh over **600 tons**. This is a modern, super-lightweight, super-high tensile strength rope (20,000 lbs per inch, weighing just 6.44 lbs per 95 feet) that assembled would be **2 feet** in diameter (or 55 individual one inch ropes) that would weigh **357 lbs per hundred feet**, or, **9.4 tons per mile**.

Even if 100,000 people could pull this much weight, **the rope alone** would span **68 miles** (4 feet per person) and would weigh **639 tons** (1.28 million pounds) added to the

ARCHITECTS OF THE PYRAMIDS

weight of the stone. Every man, woman and child would have to pull **92 lbs each** with each heave. You could have *ten teams* of **10,000** each per rope, but it would still cover almost **7 miles** per rope. It would take about 10 hours just to get the last man on the end of each heave line if they were moving by foot or “oxen”, so moving this stone ten feet would be a two-day job. And of course, they could only drag them like ham-fisted buffoons since they didn’t even know what a wheel was according to accepted antediluvian history.

At a glance, these wonders of mechanical achievement are breathtaking, perplexing and outright marvels. But there is more going on than what meets the eye. A great deal more. And the materials they are made out of hold the key to understanding what the builders of this Global Network had in mind when they didn’t just move mountains, but physically built them in the plains of what would otherwise be merely wastelands today.

THERMONUCLEAR WAR

Cheops SPOKE Pt 1

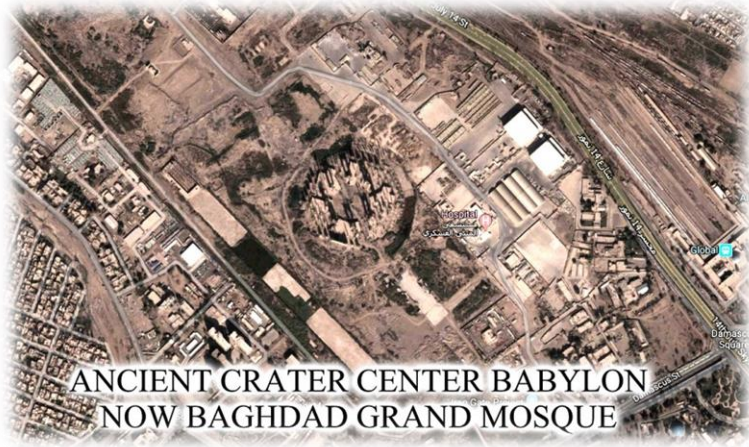

I will also take a moment to mention that where we find Cheops today might look like a wasteland now, but in the days of old when the energy network was alive and running, it wasn't that way. This is explained today by geologists and archaeologists that due to the shifting of Urth's magnetic poles, the ice age and the great flood of Noah legend, are the blame for Egypt and their surrounding lands to seem more of an area of Urth to avoid rather than where someone might want to spend a few billion man-hours erecting what was not only at the top of the list of the Seven Ancient Wonders of the World in Babylonian times, but is still at the top of the list today, many thousands of years later.

The real reason for this anomaly has been touched on before by researchers who have found overwhelming evidence of nuclear war in the wind-whipped deserts of Egypt and the areas surrounding it now filled with unending mountains of sand and wasteland. Glass. Actually

ARCHITECTS OF THE PYRAMIDS

it is factually crystal, but we call it glass today anytime we melt down “rock” to *turn it into* the clear material we pour into glass molds. But that’s not what’s happening; you are simply melting crystal into a new shape which changes its atomic crystal lattice, turning it into an insulator rather than a dielectric permittor (the conductor of cold fusion energy). If you allowed it to cool under long periods of time, the tiny crystals inside would all realign once again into the atomic composition of crystal.

There are certain types of ‘glass’ that are only created in extreme thermodynamic reactions such as volcanic eruptions, meteors or nuclear events, causing the existing rocks they melt or strike to liquefy and/or explode, fragmenting into tiny pieces of what we now call, many thousands of years later, sand. All sand is made up of crystal, whether it be from volcanic ash, the grinding down of shells from sea creatures (also crystal) and rock (also crystal) through brutal riverbeds, eruptions, or from nuclear war. The type produced from super-high thermal explosion is called *Tephra* (also known as *Trinitite*). Volcanic eruption and meteoric sand and rock is typically dark or black, while the uppermost layers of nuclear Tephra sand and rock is greenish yellow. It doesn’t occur organically in nature and is measurably radioactive.

This is a microscopic view of sand from the southern Sahara desert, the land stretching from Africa to Mesopotamia (Babylon):

Cheops SPOKE Pt 1



Covered extensively in the *500,000 cuneiform clay texts of Sumer-Ur*, Babylon (home of the biblical Abraham), was were fought by the sons of Enki; Marduke and Erra, who were continuously squabbling over who ruled Babylon. Eridu (Erradu), now Abushahreïn, Iraq, argued to be the oldest city in the world, is located in the heart of ancient Babylon just 45 miles from Baghdad, was named after Erra and theorized to be the actual location of ancient Eden. Until one day they had reached the point where Erra was willing to end all life in the land to settle their disputes and detonated seven thermonuclear warheads in the area he suspected Marduke as residing *somewhere in* at the time. He wasn't certain exactly which location for sure, as Marduke was in hiding, that's why he simply started bombing everywhere.

ARCHITECTS OF THE PYRAMIDS

According to ancient reports describing the lands consumed, these bombs collectively were estimated to have been many thousands of times the destructive power of Fat Man that was dropped on Nagasaki on August 9, 1945. Not only did this attack run the gods out of Babylon and eventually kill all the *Lulus* (a nick-name for the *Anunnaki human hybrids*) in both Marduke's and Erra's kingdoms, but devastated the ecosystems of the entire world while turning Eden also known as the *Fertile Crescent* where these *Anunnaki Sumerians* came from and vast areas surrounding it into *millions of square miles of nuclear sand*. So great was this holocaust that even to this day the name of the man responsible for this global destruction means to *err*, the real etymology of the term *error*.

An independent, exhaustive study of the date when the weather changed suddenly in Mesopotamia, leading to the end of the *Akkadian* and *Sumerian* civilizations around Babylon causing aridity, windblown dust storms and radiation damage was performed by **Peter B. deMenocal** of the *Lamont-Doherty Earth Observatory of Columbia University*. The study was published in *Science*, April 27, 2001, stating that the event would have had to have been 4025 years ago (+-125), or, 2024 B.C.

The exact same date was given in radiological studies by other sources in early April of 2000. This same date of 2024 B.C. was also given within the 500,000 clay texts of Sumeria. So if clay tablets kiln-fired to become solid rock isn't good enough for academia to validate actual written

Cheops SPOKE Pt 1

history on something other than *paper*, perhaps repeated, independent scientific analysis will finally break through.

The metropolises of Babylon even today are considered the most technologically advanced in human history, outstripping even ancient Egypt, and their sudden and unexplained disappearance has never made sense without the explanation they literally destroyed themselves through the misuse of energy. (Not a big surprise, as that was the same thing that killed every living being on Tara Urth 550 million years ago as well.)

Here is one Sumerian cylinder seal explaining what happened, however the event was documented and expounded on through many passages of the ½ million historic records of Sumer-Ur. Note that their nuclear bomb 4000 years ago appeared identical to our *Fat Man* thermonuclear war head. If you think this is a coincidence, you are mistaken:

ARCHITECTS OF THE PYRAMIDS

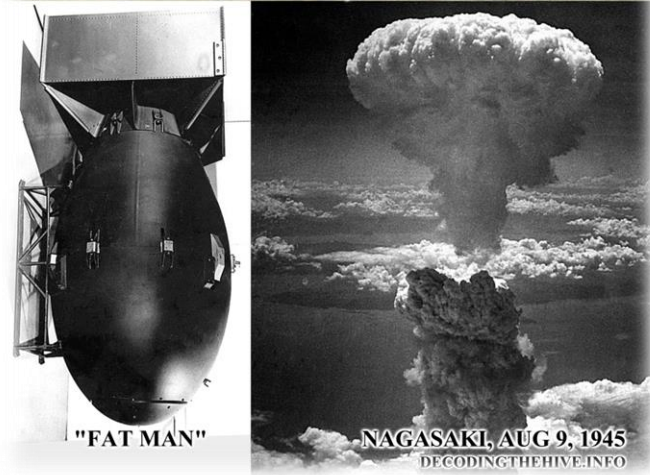

When a nuclear explosion creates glass, sometimes in large chunks, mostly in sheets or fine particles, it has a yellow-green hue as mentioned. Below is Libyan nuclear glass scattered across what was once a lush and picturesque area, now the *Sahara desert* which actually stretches beyond the edges of the entire Fertile Crescent and across the top of Africa:

Cheops SPOKE Pt 1



The attack created a wasteland that covers **9,200,000 square kilometers** in just the “Sahara” part of the blast zone; an area as large as the entire United States. To the east, it stretches on for millions of kilometers even further. Yes, that Tephra glass is still radioactive today that was not made by any modern nuclear event, as it predates that technology by at least many thousands of years according to analysis.

Shown in the **Silica Glass Fields** of **Gilf Kebir Plateau**, Egypt, in the **Keriba Crater** is the same Tephra glass found all across the lands regularly covered by ancient Sumerians. Here, historians refer to it as “Libyan glass”, rather than the actual radioactive Tephra that it is, allowing them to dismiss the evidence of this thermonuclear war that devastated a large portion of the planet as if from a “meteorite”, though no study among numerous have ever demonstrated any proof of that, in fact, had this crater been

ARCHITECTS OF THE PYRAMIDS

created by such an impact, it would not be lying flat, and would be more than *25 times smaller* than it actually is:



Large chunks of nuclear glass from this single crater cover almost 1800 square miles and the impact crater itself is 3,100 feet in diameter. Spreading away from this epicenter, very small “sand” sized pieces can be found from the far side of Africa all the way to Western India.

As mentioned, this recent nuclear event was written of in many of the cuneiform clay texts:

“On the land [Babylon, Iraq] fell a calamity, one unknown to man;

Cheops SPOKE Pt 1

one that had never been seen before,

one which could not be withstood.

A great storm from heaven...

A land-annihilating storm...

An evil wind, like a rushing torrent...

A battling storm joined by a scorching heat...

By day it deprived the land of the bright sun, in the evening the stars did not shine...

The people, terrified, could hardly breathe;

the evil wind clutched them, does not grant them another day...

Mouths were drenched with blood, heads wallowed in blood...

The face was made pale by the Evil Wind.

It caused cities to be desolated, houses to become desolate;

stalls to become desolate, the sheepfolds to be emptied...

Sumer's rivers it made flow with water that is bitter;

its cultivated fields grow weeds, its pastures grow withering plants."

ARCHITECTS OF THE PYRAMIDS

This event wasn't only recorded by the Sumerians themselves, but also in many religious and historical texts around the world. Two of the cities decimated by the explosions included *Sodom* and *Gomorrah* (modern *Harappa* and *Mohenjo-Daro*, Punjab province, Pakistan/ancient Eastern Babylon) so you can put this into perspective. Although separated by over 4000 years, the remains of the skeletons petrified where they stood carry nuclear radiation levels similar to those petrified in identical fashion at *Hiroshima* and *Nagasaki*.



Here is another Sumerian clay tablet that describes the nuclear event:

Cheops SPOKE Pt 1



In the *Mahabharata*, rather than the seven warheads that had been authorized by *An* (the penultimate god of the Sumerians) for Erra to use against Marduke, it refers to just one. This could well be because the surviving eye witness only saw one flash in the distance; it refers to a previous nuclear war; or everyone who was present at the time was destroyed in the blast and by the 100 years of nuclear winter that followed. Still yet it could be that the story was merely passed along to the writer by word of mouth where the count of the bombs wasn't as important as the devastation that followed. Understand that the man who

ARCHITECTS OF THE PYRAMIDS

was flying the craft that dropped the bomb(s) was **Gurkha**, the Indian translation for **Erra**:

Mahabharata:

*“Gurkha, flying a swift and powerful vimana hurtled a single projectile charged with the **power of the Universe**. An incandescent column of smoke and flame, as bright as ten thousand suns, rose with all its splendor. It was an unknown weapon, an iron thunderbolt, a gigantic messenger of death, which reduced to ashes the entire race of the **Vrishnis** and the **Andhakas** [modern **Harappa** and **Mohenjo-Daro**, Punjab province, Pakistan/ancient Eastern Babylon known as **Sodom** and **Gomorrhah** in Latin bibles].*

The corpses were so burned as to be unrecognizable. Hair and nails fell out; Pottery broke without apparent cause, and the birds turned white...After a few hours all foodstuffs were infected...to escape from this fire the soldiers threw themselves in streams to wash themselves and their equipment.”

I could go on for many chapters here to show that this devastation has been recorded as an authentic, historical event that is clearly backed by modern science, but I think you get the point. This isn't theoretical history, nor a tale of fiction, but a well-documented attack. Babylon was not only powered, but nuclear powered and pre-dated the golden age of Egypt by tens of thousands of years.

Cheops SPOKE Pt 1

Even before the error of Erra, the Sumerians had already taken over *Egypt* (*Thoth*, among others) where they reigned there as well for thousands of years. The half-man/half-animal Pharaohs of Egypt were actually Anunnaki whom I now refer to simply as *Sumerians* just for simplicity's sake, as previously mentioned.

Here is the overview of the blast zone event created by Erra, with the Keriba Crater in the dead center that Sumerian and Indian history has vowed never to forget. This is thousands of times the power of a modern-day thermonuclear detonation that saw to it that almost ½ of the crust of the planet along the equator was instantly turned into a wasteland of nuclear, *Tephra*, sand:



Not factoring in war or other hardships, the life expectancy in Afghanistan at time of birth is one-half (52) that of their

ARCHITECTS OF THE PYRAMIDS

counterparts along the equator in Peru, South America where the oldest person is recorded at 117, due to the lingering radio isotopes still covering areas close to any one of 7 of these unthinkable horrific bombs, over 4000 years later.

The Atlantean/Sumerian/Egyptian *Thoth/Hermes*, besides claiming to be a half-animal *god*, also claims to have built the *Great Pyramid* (he likely rebuilt it, but didn't actually create it as covered earlier):

Emerald Tablets of Thoth

Tablet 1 [annotated excerpt]

*“....Now for a time I go from among them into
the dark halls of Amenti, [turnstile stargate below
Cheops]*

deep in the halls of the Earth, [snip]

*....Raised over the passage, I, a mighty pyramid,
using the power that overcomes Earth force
[gravity].*

*Deep and yet deeper place I a force-house or
chamber;*

from it carved I a circular passage

Cheops SPOKE Pt 1

reaching almost to the great summit.

There in the apex, set I the crystal,

sending the ray into the Time-Space,

drawing the force from out of the ether,

concentrating upon the gateway to Amenti. [snip]

*....**Builded I the Great Pyramid,***

*patterned after the **pyramid of Earth force,***

burning eternally so that it, too,

might remain through the ages. [snip]”

[Note where he claims that the Great Pyramid was ‘patterned after the pyramid of earth force’. You will find out what this means before the end of this report.]

Prior to coming to Sumer-Ur and then later to Egypt, *Thoth the Atlantean* had left the capital of Atlantis (very hastily as it was being destroyed) known as *Noahasa*, when that entire continent was decimated by an anti-matter beam directed at the ground below and sent to the bottom of the Atlantic ocean in **9958 B.C.** (Later these waters receded, and I will show you a photo of it as it appears today a bit later in the report.) He arrived at Sumer-Ur with a handful of his closest friends and family members in what was called an *Arc* (a time craft, not a boat, likely named after the *Arc of The Covenant of Palaidor* which was being

ARCHITECTS OF THE PYRAMIDS

stored in that area below the Great Pyramid), and touched down in the mountains overlooking the *Fertile Crescent* of Babylon on *Mt. Ararat* called the *Caucasus Mountains*.

He and his pals took over Sumer-Ur from a group of *Angelic Humans* who had built the city over the previous millennia where he and crew usurped the identity of that race and went on to rule for thousands of years. (It is important to note, that the invader races have used Sumer-Ur as a base for hundreds of thousands of years if not longer, on and off between Tara Cleansings. This is why the *Kings List* accounts for such long periods of individual rule in antiquity.) Other members of more than 50 different off-planet invader races came from other locations to join Sumer after the flood to regroup, so it is easier to refer to them collectively under the general umbrella term Sumerians.

Thoth was later known in Rome as *Hermes Trismegistus* and then returned again as *Quetzalcoatl*, the bloodthirsty god of the Aztecs, which was the reason he is hailed as *thrice great*. Without a doubt, reading his *Emerald Tablets* (made out of an indestructible crystalline composite not found on Urth today), he certainly thinks of himself as *thrice great*. Yes, he is absolutely still here, merely in hiding.

This chapter is merely to demonstrate that the reason why Mesopotamian history has been virtually non-existent down

Cheops SPOKE Pt 1

through history until only very recently at the time the cuneiform clay tablets were discovered is because they had wiped themselves out with thermonuclear war. Not because this history is fictitious. The same thing for Atlantis, now considered myth merely because the city hadn't been rediscovered until only recently.

If you want to know where the bible came from, or where all the rest of the thousands of written religions on Urth today came from, all you have to do is read those stone-like tablets that pre-date all other known history by many thousands of years. It is all there; the flood recounted by over 500 current religious ideologies, the parting of the red sea, the chosen people's escape from bondage to the commandments handed down from god from the burning bush.

We could waste months on that history alone, but this report isn't about that, it is about the pyramids that were built tens of thousands of years ago to stand for eons as highly practical devices that humans needed for their evolution and the critical fact that humanity needs to reactivate them now or continue to scrounge around as slaves, spending 80% of their time just sourcing energy. Energy has been free since the beginning, and only recently has it been stolen from us purposefully.

CHAPTER 3

GEOPOLYMER SILICON RESIN



You are about to learn that Cheops, or *the Great Pyramid of Khufu* wasn't an ordinary pyramid. Or better described as; an ordinary *harmonic generator of ultrasonic cold fusion wireless energy*. It was built to produce the signal, and regular "pyramids" – *Transponder Temples* – were rebroadcast towers that worked similar to how WiFi range-extendors work today. But before we go into the science of how these Energy Temples actually worked, let's take a look at how they were reconstructed at the beginning of Egypt's resurrection. And yes, Egypt existed long before

Cheops SPOKE Pt 1

the animal-headed fake gods showed up to conquer the city in post diluvian history.

There are some things regarding what we call stone today that have not made it to mainstream knowledge for one reason or the other. We assume if it looks like a rock and it acts like a rock, and we found it in the backyard, forest or desert, that it is, in fact, a rock. The rocks making up the pyramids certainly do look like real rocks, so what does Wikipedia have to say on the matter?:

*Wikipedia: **Rock**;*

*“**Rock** or **stone** is a natural substance, a solid aggregate of one or more minerals or mineraloids. For example, granite, a common rock, is a combination of the minerals quartz, feldspar and biotite. The Earth's outer solid layer, the lithosphere, is made of rock.”*

PRINTS IN THE STONE

And so, for thousands of years, we have continually looked at rocks like they were just that, *sedimentary (natural)* stone, or igneous rock that were created by Mother Nature. And when we come across ancient giant footprints in stone, we dismiss them as if they were carved by artists to decorate the entrances to their caves because they had nothing better to do with their time. If you know anything about sculpting, you know that the long canopy now over

GEPOLYMER SILICON RESIN

the top of this footprint that was actually squished out in front of someone's toes would have to have been from the same monolith, making carving time for that artwork take at least 10x as long for no apparent reason:



Cheops SPOKE Pt 1



GEPOLYMER SILICON RESIN



Cheops SPOKE Pt 1



GEOPOLYMER SILICON RESIN



Cheops SPOKE Pt 1



The fact is that we aren't the only civilization who has used cement. Cement comes in different textures, colors and from more than just cheap or free sand from the sea or desert. When you need certain mineral compositions, or you have no way of simply carting mega-stone blocks back to your construction site, you have to resort to gathering aggregate with a shovel, or grinding down or crushing existing rocks into chunks or fine sand, mixing them together and pouring them where you would like your building or road to be. And it's the same with the blocks that made up the rebuilding of the pyramid.

GEPOLYMER SILICON RESIN

As for the footprints, they were real. Giants did roam the Urth, and the Sumerian Adam and Eve Nephilim Lulus are, in fact, their hybrid offspring. They are now known as *the chosen ones*. Not all chosen ones are giant by any means, but the mere fact that their offspring still exist today proves that yes, there was in fact a giant gene in place prior to our modern, squatty bipeds:



The *Wholly Babble*: “There were **giants** in the earth in those days; and also after that, when the sons of God came in unto the daughters of men, and they bare children....”

Cheops SPOKE Pt 1



Hebrew Pentateuch: “The Nephilim were in the earth in those days, and also after that, when the sons of God came in unto the daughters of men....”

GEOPOLYMER SILICON RESIN



Muslim Sahih Bukhari: “Allah [Elohim Nephilim] created Adam, making him 60 cubits tall.... [this is 90 feet]

Cheops SPOKE Pt 1



*Torah: “....that the **benei elokim** [Nephilim giants of the Elohim] saw the daughters of man when they were beautifying themselves, and they took for themselves wives....”*

GEOPOLYMER SILICON RESIN



Book of Enock: "They [Nephilim] have gone together to the daughters of men, have lain with them. The women likewise have brought forth giants..."

Cheops SPOKE Pt 1



In fact, there are almost 120 faiths and ideologies listed just on Wikipedia alone that account for giants in the recent and distant past, I just counted 117. Unless every major religious organization holding such beliefs are all uniformly lying about these beings, at some point, one must acknowledge that there were actually once previous generations of humanoids on the planet who weren't our size, especially when you have hundreds of thousands of accounts and retellings of what happened to forefathers while confronting them from tribes and cultures around the world:

GEPOLYMER SILICON RESIN



Innumerable thousands of skeletons of giants have been unearthed for centuries ranging from 8 to 250 feet tall literally on every continent of the globe, along with thousands of physical proofs stamped right there in stone to prove their existence. And they always warred, because that is the plan of the Resistance, to keep us killing off the opposing hybrids of each of the more than 50 invading races who could possibly rule all of Urth one day, forcing the losing race to be mere guards for the *One World Order*. So the wars brought destruction, wiping out civilization after civilization, along with their histories and homes.

Cheops SPOKE Pt 1

On top of this, there was the continual reset of the hybrids every 3657.8 years in the cyclical *Tara Cleanse* that followed the *Nibiruean Battlestar* that would sweep past, pick up all the gold for their home planet *Nibiru*, then plate-shift Urth as it went by, wiping clean the roads, infrastructures and buildings still left from that modern world, placing the few survivors each time back in caves with sticks and stones to begin again.

After about 2500 years, when they reached the time when they were able to reinvent some of their lost technologies and were done mixing their concrete -using all they needed for each job-, they dumped out their excess and cleaned out their mixers. Just like we do today. Immediately afterwards, while walking through the construction site, a few of them would occasionally step into some piles that were still wet. The only reason why we would even imagine today that such a thing were impossible, is because we have been continually brainwashed to think of ancient people as moron cave-men by the very people who left the tracks in the concrete to begin with.

Lots of these footprints left in solid stone were human-sized, just to show that it wasn't only the Nephilim who knew about geopolymer concrete:

GEPOLYMER SILICON RESIN



Cheops SPOKE Pt 1

Does this honestly look to you like sedimentary rock, or wet concrete? Exactly:

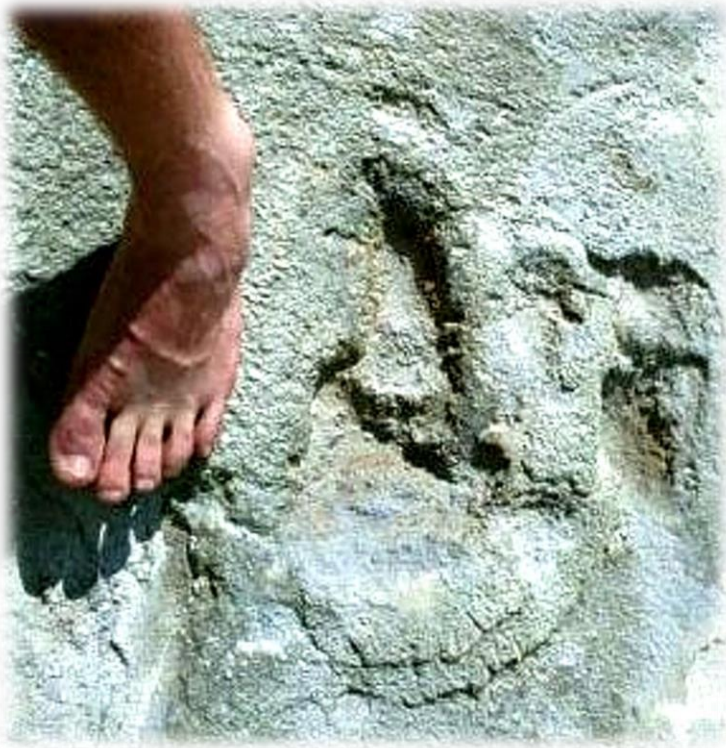

This handprint in solid limestone dated 110 million years old hardly looks like a carving, but more like what we do today when pouring a patch of concrete around our home and stamping it with our signature:

GEOPOLYMER SILICON RESIN



As for the wildly ridiculous claim these tracks solidified over eons of time into what we now call stone that was once typical mud, how many of such tracks would manage to retain their shapes had they not set up sooner than a few hundred thousand years? Right, zero.

I realize I am asking you to believe me with only this bit of evidence, so here is yet another one of the many studies indicating that the composition of the stones making up much of the pyramids were quarried locally, and many of them were poured geopolymer blocks:

Paleomagnetism study supports Pyramid man-made stone

De Joseph Davidovits

“A recent scientific study published in the renown “Europhysics News“, The Magazine of the European Physical Society, (2012), Vol. 43, number

Cheops SPOKE Pt 1

6, described how paleomagnetism study on several pyramid stones demonstrates the validity of Davidovits' theory on the artificial nature of Egyptian pyramid stones.

Conclusion:

The aim of paleomagnetic investigation of the rock material of the great Egyptian pyramids, Khufu and Khafre, was to find out the directions of the magnetic polarization vectors of their building blocks. This is one of the possible ways to verify the hypothesis according to which the blocks were produced in situ by a concrete technique. The analysis of a limited set of paleomagnetic samples provided the following results.

*The paleodirections of three sampling locations (2 from Khafre and 1 from Khufu pyramid) exhibit the common north-south orientation, suggesting that they may have been produced in situ by a concrete technique. The block from one sampling location of the Khafre pyramid is of natural limestone and evidently comes from the adjacent quarry. It is likely that the block from one sampling position of the Khufu pyramid comes also from the same quarry. Finally, we conclude that even if the geopolymer concrete technique was used, the pyramids were constructed from a **mixture of natural and artificial limestone blocks.**"*

GEOPOLYMER SILICON RESIN

So how is it science is able to tell the difference between a sedimentary stone and geopolymer (artificial) concrete? It has to do with the alignment of the crystal lattice atomic structure of the stones.

In nature, while forming huge deposits of *sediment in situ* from the many minerals in the ground all converging into a single stone we call quarries (a mountain of solid rock), heat from magma close enough to the deposit “cooks” that area under extreme heat, which melts the existing various forms of crystal together while evaporating the organic matter off such as decomposing vegetation or biological tissues as it forms.

This leaves the millions of different solids in that area melded together in a single, unified “block”. Then due to the presence of that heat remaining in the same vicinity of the deposit for thousands of years, eventually cooling down to regular surface temperatures, the microscopic crystals inside those stones have plenty of time to assemble themselves together to point in a common direction. This allows the stone now to uniformly vibrate what we call piezoelectricity. Yes, it is actually then able to generate free energy through photosynthesis from sun waves. It can now also conduct electricity through its *valence*, or the outer walls of its structure.

This atomic crystal structuring is a very, very slow process that cannot be duplicated by science, since it relies on

Cheops SPOKE Pt 1

giving the resulting stone extremely long times in order for those liquefied crystals to slowly harmonize with each other before that deposit has cooled and hardened. In the case of granite, which is made up of very high quantities of piezoelectric quartz, we can see under electron scanning microscopes that the crystal lattice of the entire mass all point in the same direction, making it now *dielectric*, or a material that interacts in different ways with electrical current.

If the same pool of liquefied stone were allowed to cool immediately, like taking it off the stove as it were, the tiny crystals inside every atom of that mass would freeze into random directions, rendering the finished product non-conductive to electricity, which we would then call *glass*. It would lose its dense color in the process, resulting in a clear or translucent body that we call non-conductors. So much of the color and the opacity of stone comes from its crystal lattice holding a uniform pattern which is lost in fast cooling, such as magma experiences when it is brought out into surface temperatures while in red-hot form, which then hardens within hours or days producing obsidian that is translucent.

Even today we use glass or ceramic achieved through melting down stones and sand, then allowing it to quickly cool to make the insulators atop electric powerlines, just like the first linemen installed for the original telegraph lines in the 1800s. Yes, this was before the invention of electricity generated by mechanical means. Telegraph lines once connected countries together for long-distance

GEOPOLYMER SILICON RESIN

communication using entirely free energy from earth battery technology we will cover more of soon. Two metal rods hammered into the ground, spaced some 10 feet or more apart, would simply supply the energy to send those signals across the land and without being hooked up to any meter :



The glass above is still made up of millions of tiny crystals inside their crystal lattice structures, the same as a dielectric, piezoelectric stone in content, but because they are not aligned, they act as insulators instead of differing types of conductors. And we would see those crystals under powerful microscopes.

If you were to crush a megalithic stone rich with quartz crystals into a million pieces, then reassemble them back together using geopolymer resin, the millions of crystals inside each inch would be facing in various different

Cheops SPOKE Pt 1

directions similar to glass, indicating that while it is still quartz, and it is still able to generate millions of tiny electrostatic torus fields across its distance, unless an *external electric field* that is *higher in voltage* than the stone's general output is placed next to the stone, it will act as a non-conductor of any electricity. If left in one piece, that giant stone would conduct static electricity from one end to the other.

So the difference between one single stone cut from a quarry and a poured concrete mix can be determined simply by testing it with a trickle of static electricity, or by looking at its atomic structure, making it impossible to confuse with a single stone.

It is important to note however, that the atomic crystal structure of "concrete" will still turn together in harmony to conduct an electric current if the stone is placed *under compression*, or if a strong electrical field is placed next to it, causing it to conduct electricity in the direction of the prevailing field, just like a megalithic stone. So while the original Energy Temples were indeed made from single-piece huge stones, and then were repaired using poured geopolymer resin blocks, the Temples would still operate the exact same way as before, as long as they were placed in an applied electret-magnetic field.

Geopolymer poured silica resin and concrete has now been identified being used all around the world in ancient

GEOPOLYMER SILICON RESIN

monolithic constructions as well of course, now that we understand what we're looking for. Pumu Punku, Baalbek, Yangshan; in fact from Egypt to Africa, Peru to Turkey, ancient formed stone has now been positively identified using these combined techniques. However, with this said, we still do find massive stones that could not have been poured, but were clearly carved right where they stood, or cut from huge stone quarries, taken often miles away and then placed one atop each other as if only the gods alone could have performed such an impossible feat.

So this paper isn't about dispelling the notion that there were civilizations in the past with technologies we do not possess today to use megalithic stones in some of their projects. Far from it. Due to the unique sonic static electrical properties of solid stone blocks of particular species, ancient builders demonstrated they not only understood energy, but on a level modern man is only learning about today.

By the end of this installment of the handbook, if you don't believe in piezoelectric sonic, also electret-magnetic as well as cold fusion and photonic quantum-mass energy generation as well as levitation, then nothing will ever present enough evidence for you to admit modern man doesn't possess the highest evolution of technological understanding to date.

Cheops SPOKE Pt 1

Moving such megalithic stones is literally easier than carrying your groceries from the car and I will show you how it is done. But a word to the wise; when we get into the science, I suggest that before moving on from a chapter or even a page or paragraph, that you re-read until you clearly understand each scientific point, otherwise when we wrap this up, you will not be able to follow how it was that mere rocks could do what we can't do with rows of hydroelectric generators the size of cement trucks in modern times. And yes, it is your actual job to know how sciency things work if you have any intentions on moving forward to a prosperous and evolved future where scarcity will be an ancient concept from the times when man used to "burn wood" to stay warm.

DUPLICATED PATTERNS IN STONE

Not only do we have the results of laboratory findings showing unequivocally that the atomic structure of such materials are not the same as naturally formed stones close to these sites that provided the aggregates, but now with the knowledge that our ancestors were no strangers to pouring concrete and making forms, we can finally see with our own eyes that the unaccounted-for protrusions jutting out or perfectly right-angle slots in these monstrous stones were merely formed in molds, just as done every day in modern times. In some cases, there are quite elaborate reliefs that are precisely duplicated, one-after-another with no variation:

GEOPOLYMER SILICON RESIN



Then there are jigsaw pieces that have no gaps whatever in their seams that would be impossible or at the very least unthinkable time-consuming to achieve if you were actually using individual stones, but child's play if you were tinting slurry and filling in the mold one "stone" face at a time. The shape below where the edges curl in is known today as slump stone, a geopolymer, poured composite:



It can be poured in mass production, or it can be injected, giving each outline its own composition:

Cheops SPOKE Pt 1



Only because we think of our ancestors as dolts, do we consider them unable to form a simple pattern in their walls and walkways to add a bit of visual artwork to their everyday lives:



GEOPOLYMER SILICON RESIN



This perfectly flat, gigantic stone is actually just a common poured section of a once much-larger floor. See the squared notch at bottom right where there was a wooden beam at one time at the bottom of the form to lock it together to the other floor sections being poured next. The only reason that notch wasn't perfectly rectangular as it would have been had this "megalith" been hewn prior to laying it down with the notch below to lock it in place is if the pour had been over a wooden beam not perfectly rectangular:

Cheops SPOKE Pt 1



The problem is, until you look at it from this perspective, it is impossible to see that the surface of the stone is actually the surface of concrete, and that forming liquefied castings is just an everyday occurrence:

GEOPOLYMER SILICON RESIN

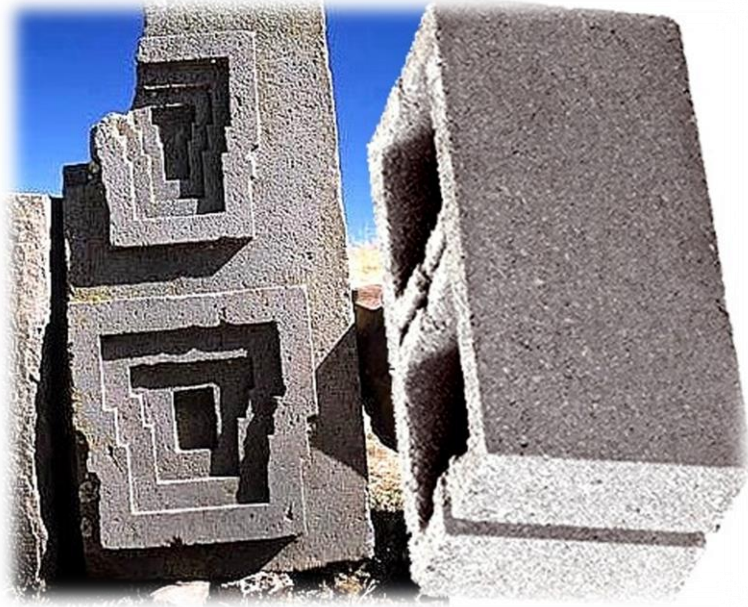

FRANK LLOYD WRIGHT

You will learn where this pattern used in Wright's architecture actually came from later in this report. It has been around much longer than any Egyptian structure:

Cheops SPOKE Pt 1

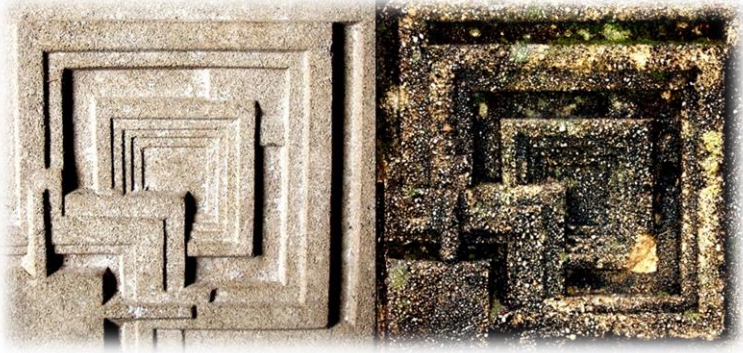

Freeways:



Just like the first time you realize plateaus are actually ancient tree-stumps, once you see it, you can't unsee it:

GEOPOLYMER SILICON RESIN



The image below was from *watershedmaterials dot com* website, explaining how blocks from pyramids were tested under electron microscopes and analyzed, showing conclusively that many of the blocks were in fact *geopolymer silicate resin* rocks that were cast in place, showing proof by the fact this “stone” has a section at the bottom that had seeped out of the mold. An excerpt from the author’s comments are shown below the image;

Cheops SPOKE Pt 1



“A ground level block in front of the Great Pyramid of Khufu includes a irregular lip at the bottom that would have been very hard, and somewhat pointless, to carve. This lip indicates that the block was cast in place - the material in the lip having slid out under the temporary wooden mold before hardening.” Image © Michel Barsoum

This is not the only example we have of these stones being poured cement. This image between the massive Basalt foundation stones and the pavers around Cheops makes it abundantly clear this was absolutely not carved:

GEPOLYMER SILICON RESIN



When even mainstream geology claims there was more than one half million tons of concrete mortar vastly stronger than anything we have today that sealed off all the possible air gaps between the stones of Cheops, how could we *ever* imagine that they would have no idea of what a concrete form was? Those who built the ancient *Temple of the Sun* in Corincancha Cusco certainly did:

Cheops SPOKE Pt 1

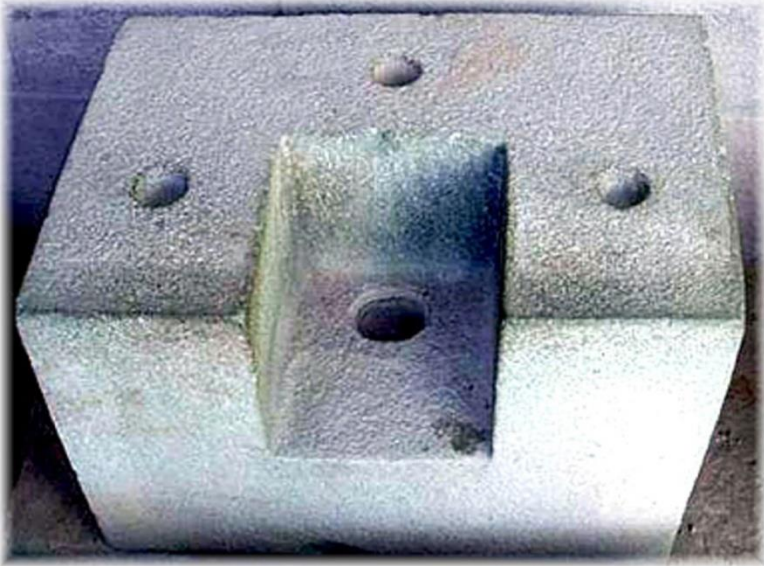

But then there is the actual type of stone itself that we are talking about here that made up 90% of Cheops; chunky-grain granite. What does geopolymer stone look like when you crush rocks and crystal, mix them in a slurry, cut and polish them? That would be granite:

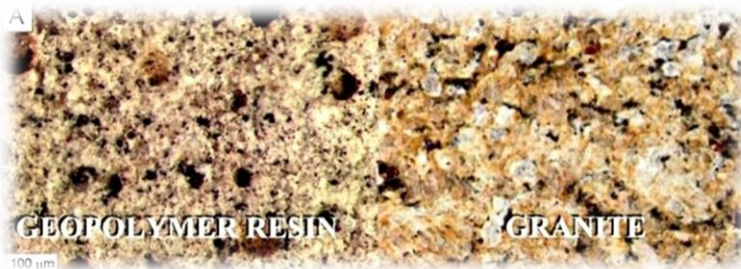

CHAPTER 4

THE HIDDEN EYE OF HORUS



When taking *atmospheric ionization* readings from the area surrounding Cheops, EMF (electromagnetic field) meters show that the air is holding the *same level* of energy as created only during a lightning storm. Lightning bolts bring down high levels of ions that fuse into the iron content of Urth, causing a crisp, or electrical quality not normally found at any other time. But how could this be? These questions and thousands more have prompted thousands of studies of the Great Pyramid, possibly hundreds of thousands by now as previously touched on. Each year

Cheops SPOKE Pt 1

increasing in scientific precision with exponential accuracy in an attempt to drill down to, pardon the pun, concrete answers. Fortunately this trend isn't abating. The more powerful our devices become, the more scientists are taking another look, because there is one thing that is certain; pyramids that require greater resources and take longer to build than the most impressive castles in all the world clearly were more than just crypts, and laboratory and algorithmic computational analysis reflects that. Piles of random rocks don't change the standing atmosphere around them just by chance. Research is only increasing now, centuries later.

DARK MATTER DEVICE

Cheops was fitted with a steel pyramidion in 1874 by astronomers to show where the capstone peak would be if it were still present – or so went the story. Indeed a very modest and unassuming retelling of dragging heavy and cumbersome *20 ft long* (2 stories high) steel pipes all the way to the top of this man-made mountain and securing it strong enough to last for more than 150 years:

THE HIDDEN EYE OF HORUS



There is a much more sinister explanation for this addition being left behind than simply because it was too much work to bring it back down with the astronomers; it was placed there to turn the safe, piezoelectric, ionic energy radiating from its peak into electromagnetic energy right at the capstone. Simply put, the energy focused on emitting from this precise point would have entered the atmosphere as it had done in ancient times before Cheops was restored, without making the transition to *electromagnetic* radiation, which will be explained further as we cover exactly how energy works.

Even though Cheops is no longer fitted with its many devices that were once in place that generated the unthinkable levels of energy it had in previous times, it still emits massive levels of power by the sheer fact that the stones themselves are continuously creating enormous levels of piezoelectric waves. Adding the steel pyramidion

Cheops SPOKE Pt 1

to create a *Dark Matter torus field* was a cheap and simple way of irradiating everyone in this immediate vicinity. And, seeing as this is the number one historical destination on the planet, hosting 14.7 million visitors annually, that is a lot of humans who aren't being properly bathed in cancer-causing electromagnetic radiation.

Due to this clearly readable electromagnetic signature emanating from the Great Pyramid, it has become obvious to modern scientists that pyramids do indeed produce energy. The materials are right, the "plumbing" is right, and the physical proof the energy coming out demonstrates without question this is right. Though they don't know how it could have functioned to provide the levels needed in order to run ancient communities greater in size than the largest cities we have on Urth today, as found recently in the jungles of Guatemala called *El Mirador* that has *hundreds* of pyramids surrounding it. Or how to grab this energy and use it safely in our homes without a meter telling us how much to pay some guy who sips \$150,000 dollar bottles of cognac while over a billion people are starving in the world. This is because we still haven't totally broken the code of *superconductivity* (for mainstream use of course. The elites have been using it for decades or much, much longer).

Today it is well known within archeological and scientific circles, that pyramids emit a different kind of energy from where their capstones should be located other than just electromagnet electrons as found in Cheops' case, known as *electrostatic ions*. Going off of testimony from ancient

THE HIDDEN EYE OF HORUS

historians, the square pyramid-shaped capstones were covered with either *yellow gold*, or *electrum* (white gold) over *diorite* (Basalt) *granite* or fine *limestone* monolithic rock. Without this gold covering, the only energy that would have emitted would have been static electricity, or, the same exact type of energy already in the air.

Ion sensors have been taken to the tops of existing pyramids where the now-flat peak areas are located, only to find unusually high readings emanating from the structure below. This is not electromagnetic energy as read around Cheops, which is thanks solely to this one modest-looking metal teepee that was only supposed to locate the exact peak of the missing capstone for astrological bearings. If that were actually true, then there is no argument to support this being made out of iron when lightweight wooden poles would have been far easier to not only transport up this mountain, but also to work with once there.

The cover story simply does not work with even the briefest consideration, and like the other millions of yarns we have been handed, we believe it, only because it was of no real interest to us at the time of our education. This teepee turned that mountain of piezoelectric static electricity into a microwave oven with the door standing open the size of an ocean barge.

Static electricity is photonic energy or *light wave* energy. The phenomena of such energy when generated by a

Cheops SPOKE Pt 1

crystal-driven device or in nature (such as the *aurora borealis* or *solar wind* in space), is referred to by science as *photons, plasma, static electricity, piezoelectricity, sonic/ultrasonic energy, gamma waves, photonic energy, pyroelectric, electrostatic, phonons, cold fusion* or simply *ions*.

No matter what nonsense science attempts to pass off as differences between each type these energy waves are, they are still the same things. Ions. Yes, you might not be able to see “sonic” waves, but the energy carried by that invisible wave are still ions, which are still photons. You just can’t see them, just like you can’t actually see gamma waves either, but only a sliver of that spectrum far further down the “frequency scale”. Below that they are called *sound*, but above that, they are also called *sound*. Only in between these frequencies are they called “light”. Hmmm.

Photonic waves can be turned into “regular” electromagnetic energy (“electrons”) easily, something we have been doing for a very long time already, but something that never makes the front page. To us, electricity comes from hydroelectric generators at the Hoover Dam or Niagara Falls, or from wind turbines (windmills), and those who are harvesting energy from the sun with solar panels are all *sort of playing* a game; fringe morons not to be taken seriously. The reason for this is simple; static electricity is “subtle” when compared to the power carried by electromagnetic electrons, therefore virtually dismissed as a viable source. But that’s not what is really going on. You will soon learn that the *weak force* is

THE HIDDEN EYE OF HORUS

actually many hundreds of times stronger than the *strong force* that holds atoms together. Then you will see exactly what they meant in the babble that darkness will be called light when you learn that the “strong force” is actually Dark Matter and the “weak force” is Light Matter energy that has been hidden from you all this time.

Before you are finished with this paper, you will understand that the energy in water, the energy in rocks and metal, in the sun, in the wind, and sitting right there floating in the air, are far more than just real, and far more powerful than the rudimentary energy ever gotten out of a turbine motor spinning from water current or driven by the simple movement of wind. Trust me when I tell you, that the biggest energy-consuming device on the planet, CERN, which uses the equivalent of ***three hundred thousand household's*** worth of electricity every minute of the day while in operation doesn't have power lines coming in from some other outside source no matter what cover story they use. Well, that's. um, wait... what?

SPECTOGRAPHY

Spectrography or simply *spectography*, is the science of measuring *photonic* waves, not *electromagnetic* (electron) waves. One is the spectrum of light (which is color which is actually sound), the other is electricity driven by an electromagnetic field of reversed Dark Matter attraction and repulsion. Both are “electricity”, both travel using

Cheops SPOKE Pt 1

magnetic fields, and both are secretly sound waves. However only photons offer the ability to sidestep the limitations of Dark Matter energy we use in every electric and electronic device today.

There is a distinction in science between **electrons** and **spectrographic photoelectrons**, because photoelectrons are designated as *static*, meaning they don't want to budge from where they normally are without using something other than metal to direct out that current. As soon as that photoelectron moves to another atom to form a molecule, science immediately then drops the term photoelectron and ion, and uses simply electron to describe the strong force. But in truth, these are all still ions, only now changed in *parity* (states) only.

Science is well aware of photon energy as seen through, among other methods, what we call spectrography today. The name spectrography comes from the word *specter* (or spectrum, where non-physical forces seem to abide). Of course you are familiar with what a *specter* is; it is synonymous with ghost, apparition, spirit, wraith, etc. The *unseen*. Standard Model Science is quick to dismiss specter phenomena merely because within the lexicon of science, you must be able to measure the mass of something for that something to be truly real, even though mass has been an unproven theory since its inception.

THE HIDDEN EYE OF HORUS

The only way they can “weigh” something is through its *vibrational signature* that comes from the *oscillation* that is the *magnetic attraction* and *repulsion* that magnetic energy carries, because nothing, at its quantum core, has *any* actual weight. Subatomic particles, while highly studied, are also largely dismissed, due to their lack of this measurable weight of magnetic pull, relegating it to specter status. But at the same time, the most expensive scientific machinery ever developed measures specters or spectography all day, every day at places like *CERN* and other particle colliders that cost unacknowledged billions and even trillions of dollars to build. The *weak force* (ions which are invisible photons) is only measurable through its influence it applies to the strong force, thus, it is regarded as more of an obstacle than energy.

This, as you will see, is merely the *Standard Model cover story*, not what above-top-secret sciences actually work with. They know what photonic energy really is, and weak isn't one of its descriptive verbs unless it is being used in the Standard Model deception/description as the weak force. An **electron** (-) (the strong force) has an antiparticle shadow wave that is called a **positron** (+):

*Wikipedia: **Electron**;*

“When an electron collides with a positron, both particles can be annihilated, producing gamma ray photons.”

Cheops SPOKE Pt 1

In simplified words, an electron is the Dark Matter side of energy, and static electricity is its opposite, antimatter wave positron.

Science likes to call the positron an ion, and differentiates between the two in how they act once they change parity, never bothering to use the word positron. These are one single unit, but ambiguated to seem like two different things. Just like the neutrino changes parity (from positive to negative), so do photons. No matter what state that “particle” wave force is in at the moment, it is still a neutrino and electrons are still photons (ions). The energy is still there, only again, in parity (dipole magnetic moment) of each other:

*Wikipedia: **Antiparticle**;*

*“In particle physics, every type of particle has an associated antiparticle with the same mass but with opposite physical charges (such as electric charge). For example, the antiparticle of the electron is the antielectron (which is often referred to as **positron**). While the electron has a **negative** electric charge, the positron has a **positive** electric charge, and is produced naturally in certain types of radioactive decay. The opposite is also true: the antiparticle of the positron is the electron.”*

And the why of this cover story that electrons are actually photons at their core is clear; because all forms of energy, all forms of “matter” and “mass”, and all *movement*

THE HIDDEN EYE OF HORUS

(animation) of any kind; be it within the physical realm or outside of our visual or perceptible spectra *spectrum*, owes their power to the neutrino which imbues protons with photonic wave force energy. It is the *super strong force* of all living matter, and it is the medium by which all things are viewable; because the photon called the neutrino is the particle that visibly, under electron scanning microscopes, is what passes the thing we call energy on to other stasis particles (salt) that then become magnetic-electric. Be it simply vibrating like piezoelectricity, vibrating ions, or vibrating electromagnetic “electron” energy.

That energy is 100% of the time magnetic, so 100% of the time it has two different, resonating waves of opposite parities. It can be transformed into many different versions of itself, but in the end, magnetic attraction and repulsion is the foundation of all forms of energy once the neutrino has delivered it safely into the 3D realm. Electron/positron energy is proton/neutron energy is cation/anion energy, just at different levels (valances) of the nucleus of the **ion**.

When boiled down to its pure or *quantum* essence, all references to electromagnetics is translated as heat, called “*thermal electricity*” due to the reactions of electrons attempting to pass through a resistance (like copper wire), giving mechanical energy a thermal signature. The power of a *superconductor* to *suspend the forces of gravity* and *sidestep* thermal resistance comes from its ability to move pure energy instantaneously without friction (resistance). And it does so using phonons (the expression of sound), which carry *unlimited, eternal* power that is *not* subject to

Cheops SPOKE Pt 1

all *claimed* laws of physics. Electromagnetic energy is limited to the size of the conductor (wire) it is being channeled through, as well as the resistance of every inch of that material. Phonon/Photon energy has the power to sidestep such resistance, as we will get to soon.

So when I refer to static, stasis or photonic energy, just realize that this is an immeasurable superfluid wave force phenomena, not ox-cart-slow electromagnetic energy where the speed of light has any bearing at all. It can *become* electromagnetic electrons only once it has “crossed the veil” (referred to as a *valence*), but while in a state of “stasis” or dormant energy such as carried by the photon in either color or sound, it is electrostatic energy.

I mention spectrography here simply because we will be dealing with photonic energy throughout this report and having all this in your mind before reading on will give you a better perspective how it is all these “magic” things happen I will be explaining throughout this disclosure. It is easy to just mumble the word aether to explain away the inexplicable, but it is another thing to show you the scientific proof of the aether that man has secretly been working with for many decades already, not saying a word about it to you. While flower power is nice, I prefer hard clinical data and reproducible empirical evidence and suspect that you do as well. Spectrography offers us a peak into the hidden vaults of *real* power.

THE HIDDEN EYE OF HORUS

CAPSTONES

The pyramid of *Amenemhat* is located just 40 miles from the Great Pyramid of Cheops (also known as Khufu), meaning that the construction of both their capstones were almost certainly made from the same material. I will be focusing mainly on the materials that make up the Great Pyramid, merely because it has the most extensive geological, archeological and assay studies of any pyramid standing today, and only reference Amenemhat's capstone here due to the fact that this part of Cheops/Khufu's is now missing entirely. Of *course* it is.

Since the capstone of all the ancient energy generators are one of the biggest secrets to their power, and act like the *switch* (which keeps them in stasis when removed, not unlike removing the distributor cap from a car), they were each taken down deliberately at the time the global energy network was mothballed not long after the *Zeta/Draco Quarantine Frequency Fence* was installed in **9,540 B.C.** to block all ascension and visitations to and from Tara Urth. Not that each one was a functioning stargate, but the focus of this article, Cheops, was.

By the time you understand what level of power was actually generated inside this key *Control Temple*, you will understand how that stargate was able to resource the kind of energy required to demolecularize someone on the order of nuclear vaporization, which is required in order to evaporate all moisture from a physical body in order to

Cheops SPOKE Pt 1

relocate those particles inside a dimensional field where the frequencies of manifestation are simply different from the physics of this plane.

Any form of “moisture” (called “amneo fluid”, or the fluid electrolyte “wires” that allow animated life to manifest) from one playing field is not compatible with the electrical system of the next. Rather than “short circuit” upon arrival, visible “matter” simply doesn’t materialize. We won’t get deeper into that subject here, but the energy itself must be on the order of a particle collider in order to translocate an Avatar from one dimension instantly to another one, which is why Pharaohs were carefully embalmed to remove every single drop of moisture out of that Avatar’s body upon death, which would otherwise hold that Spirit Essence “hostage” in this plane.

Cheops’ energy field did reach down into the subterranean Halls of Amenti where the gate was located. Yet until you learn more about torus fields and superconductors, it won’t simply be apparent how that level of energy could possibly be provided to a stargate, or how a stargate made entirely of stone would ever work to conduct enough electricity when it is *dielectric*, meaning it is factually a non-conductor.

You will likely never find one pyramid with its capstone still remaining; even those buried under millions of tons of soil today. And the last thing you will ever find inside one of these powerhouses would ever be the tomb of anyone

THE HIDDEN EYE OF HORUS

who had any idea of what they were built for. The Pharaohs did know what these Temples were, and a mausoleum wasn't it. This incredibly significant and now-missing stone from the tops of the Cold Fusion Energy Temples are dangled purposefully in our faces with every dollar that passes through our hands with the *Eye of Horus* (**now inside the *hidden* capstones from every pyramid**).

The Eye has been used to depict the power emitting great light floating above the pyramid since time immemorial. It is now even synonymous with *pyramid* today, as often as it has been shown. The *secret* of secrets:

USA:

Cheops SPOKE Pt 1



UK:

THE HIDDEN EYE OF HORUS



Cheops SPOKE Pt 1

UKRAINE:



ESTONIA:



NICARAGUA:

THE HIDDEN EYE OF HORUS



TURKEY:



SWISS:

Cheops SPOKE Pt 1



Horus and *Ra* (both are terms used for Marduke) are equated as the same person in history. The *Eye of Ra* is also known as the *Eye of Horus*, a rather significant favorite and mysterious *Hermetic secret* that is gestured by too many celebrities to mention using their forefinger and thumb around one eye as code to their supervisors they are still to be trusted with *the* secret.

The *Eye of Horus* was a term given to a covenant connected to the *Co-Evolution BioRegenesis Treaty of Palaidor* four million years ago. It was a special passage whereby those under the Treaty, and not carrying the *Axious Seals* and *Amenti Seals* were able to ascend. This comes from a far, far older (hundreds of billions of years), special system used in the previous world where some of

THE HIDDEN EYE OF HORUS

the human hybrids of today originally came from which I won't get into here. The Eye of Horus was a tricky process involving DNA constructs and interplanetary transmutation, so it was *threading the eye of a needle*, and the name was attributed to *Horus* for one reason or another.

This treaty still has lingering references to it even today in the now nearly-forgotten *Eye of Isis* also known as the *Camel's Eye Treaty* where the Vatican officially received the deed to all lands above water on the planet on **July 2nd, 408 A.D.** that still remains in their subterranean archives. While the actual treaty had nothing to do with Sumerians holding "rightful" title to Urth as this agreement is in reference to, the terms used for that compact with all who wished to do barter throughout the modern world at the time still carries reference to the actual designation, the Third *Eye of Horus*, which is synonymous with *Isis*. The original treaty is also still referenced ambiguously in the term *passing a camel through the eye of a needle*. This was a cipher code passage in the Wholly Babble for elites to understand and the rest of us to scratch our heads over.

RA, OSIRIS AND HORUS

Horus is said to be the son of *Ra* or *Osiris*, while modern historical (hysterical) understanding place him as the same being.

Cheops SPOKE Pt 1

I have written about this subject before, that the name of *Amen Ra* is extracted from *Ka-Tha-Ra*, which refers to the *plasma* body:

KA= Light

THA= Sound

RA= One

So we have the god “Ra” choosing the final one of the three sacred tones of the full light body, claiming to be the whole or the ONE god of the elements of the plasma field.

As I have said many times, the names of rulers are not names, but titles. While in that position, then you are referred to by that name, but the name describes the *position*. A King is *The Khan* (or *The King of the children of Khane*) for example. All the prominent leaders of Rome were given new names when they took the throne. The same applies even today. Once you have become president of the United States, you are *President Trump* from that time forward, not *the Donald* anymore. The *Ra* was the *Keeper of Amenti*.

As already mentioned, the physical location of the *Sphere of Amenti* is in Giza, directly below Cheops. It holds, as you recall now, the *Soul Essences* of the *Lost Souls of Tara* (LST), or those lost in the *Fall of Man War* when Urth fell from the 2nd Density, and the 4th Dimension of the Gaia Time Matrix to the 1st Density, 3rd Dimension. The *Sphere*

THE HIDDEN EYE OF HORUS

holds the *crystal fragments* of the *past-life history* (past-life memories and accomplishments plus detritus, called *provenance*) of all those who were vaporized in the blast that nearly ended Tara Urth's life as host within the Gaia Time Matrix. Those Soul Essences carried the provenance (we might call karma) of each person lost, now fractalized into "trillions of pieces" that were all placed into the Sphere when their particles returned to Tara's atmosphere from the *asteroid belt* in the form of space dust, and were finally present in enough particles to *piece back together*.

This would be a *very* long process which would involve the special harmonic frequencies of crystals not of Urth origin that would be placed into a box that would produce energies to assist in *stargate-passage* (mechanical passage) to those who were able to use the process of the Third Eye of Horus ascension. That box is known today as the *Arc of the Covenant*.

The *Axion Seal of Palaidor**, also known as *the Seal of Amenti*, placed on all beings who were still repairing their fragmented crystal memory particles, kept all those Soul Essences held within this one dimension until they were able to *knit* back together, as a collective, the individual personas or *personalities* of each of the lost souls. Something that is far too complex to sufficiently explain here. The Sphere represented tremendous power over the now-enslaved LST to anyone who held the **keys** (KEYlon Codes) of passage to the Halls of Amenti, making the area of Cheops the most important geographic location on Urth,

Cheops SPOKE Pt 1

even though it remains today as nothing more than a disabled monument to technologies long-since forgotten.

Axion is in reference to the **time-stamped axiatonal fields of DNA markers of specific hybrid bloodlines.*

When the Global Cold Fusion Energy Temple Network was taken off-line, and the Arc of the Covenant was stolen by Moses, this closed down the turnstile ascension gate, including the passageway portal to Amenti, and stopped all Lost Souls of Tara from leaving this plane. It also turned the once-brilliantly lit *pyre* of Cheops dark. (Hint: pyroelectric.)

When the capstone was removed from Cheops, as well as from all the rest of the network generators, the energy of the grid would be gone, the Arc (key power source) was now gone, the Halls were now closed, and the secret of *Amenti ascension* would be lost to mankind until the time of the next *Stellar Activation Cycle*, which would not require any of those things in order to ascend. That Cycle began around 12/21/12 and is now more than half-way through its process. Until such time, it was the rock-solid quarantine of planet Urth. The *Eye of Horus* illustrated within the glowing capstone is the *Command Signet* to keep the Sphere of Amenti in stasis, and those Essences here and enslaved.

THE HIDDEN EYE OF HORUS

Amen Ra was the *position* of the Pharaoh, not the name of the guy. He was god over the Lost Souls of Tara, standing in the position of the *ONE*, or the *Annu-Elohim*, who are unable to manifest within the frequency of this dimension. He was tasked with keeping closed the passage of ascension through the *process* of the Eye of Horus. Today when you pray and end that prayer in the word Amen, you are powering the intent of Amen Ra.

CHAPTER 5

ELECTRICAL ENERGY



This report isn't just about how you can generate free energy; it is also about how to use it safely. We will be moving into the scalar vibrational science of how the Energy Temples actually function, but first I am going to explain the secrets of electricity, so you can understand how electrical science manages energy. Without this, you will be lost in understanding how it is that sonic vibration amplifies electricity, and how mere stones are able to perform in the way they once did previous to the latest collective recycle. Here's where you begin learning that

ELECTRICAL ENERGY

100% about the way you have been taught to access energy has been destroying you since the very first camp fire. That energy won't be going with you into the next dimension. At least, not in the manner you have become accustomed to.

From here on out we will be speaking about how water isn't just water, rocks aren't just rocks, and electricity isn't what you thought it was. These are some of the terms science uses to reference energy in its many forms that we will be referencing in our true explanation of the power mankind is largely leaving dormant.

DISTRIBUTED ENERGY RESOURCES

Moving energy is termed as DER, or *distributed energy resources* by electrical science. Mankind has now entered a phase where the distribution of energy is causing all sorts of challenges, not just in how to deliver power, but doing so safely. The most important of which is the struggle to leave fossil fuels behind in powering automobiles, making the switch to electric in a Hail-Mary to save our atmosphere that is currently being destroyed at an inconceivable rate where more than **200 species of living plants, animals and insects are going into extinction every single day**, between 6,000 and 10,000 each and every year.

Each one of these represents millions or billions of years of technological development and millions of hours to

Cheops SPOKE Pt 1

engineer. When they're gone, they will be gone, just like the white rhino we forever lost a few months ago. Regardless of what you choose to power your cars with, until you understand energy and what it is, you will be unable to make the transition from radiation to ionic energy, simply because the public doesn't understand that Dark Matter is bringing humanity to an extinction level event that will soon be impossible to avoid. You aren't losing 6,000 to 10,000 species a year because that's just what species do, die. You are losing them because you are irradiating the whole planet into a second Mars.

All life exists due to water. Water is the filter by which the ecosystem of man is able to survive. It rinses the air and vegetation clean, flows down streams and filters the waste products of each species, then percolates down through the soil, only to arise clean and new again to make another round from ocean to clouds and back. Once the soil has become too toxic for the organisms within to continue "rinsing the filter" that keeps the air functioning, there is nothing available to replace it. And just as has happened thousands of times in the past, humans will come to another self-extinction event.

The difference is, there will be no more seedings to the Angelic Human project, as its long-cycle of evolution is now over and it is time to move forward. The planet you will be moving to will be this one, not a new one. If you wish to move to any higher dimension, you will need a planet in order to have a playing field. You have no choice but to save this one in either case, because the 4th

ELECTRICAL ENERGY

dimension isn't "somewhere else out there in space". You get five culturing fields with 15 levels, not 15 planets to destroy along the way.

The DER engineers of this civilization, who understand that electromagnetic energy is destroying humankind, unanimously agree that something major is going to have to be done in order to stem the tide of destruction. Simply erecting more and more electric lines to keep powering the world is not the answer. The system itself, is broken. Unfortunately the only energy structure you have ever known has been the wrong platform. Fortunately, you will learn how to begin the transition with this report, minimizing or avoiding altogether your horse and buggy days. Your biggest challenge will be to unlearn everything you have already been taught about science in order make the leap.

INVISIBLE ENERGY WAVES

Energy comes in *invisible wave* form. The sun emits neutrino waves that enter the atmosphere and sends the wireless signal to *Aniline* crystals that transfers celestial energy into safe form that powers all life on the planet.

Energy is *aether*. Sunlight does not carry heat, it is merely ultrasonic sound waves. Those sound waves carry the message of "energy", just like a pebble tossed into a pond

Cheops SPOKE Pt 1

carries the message of “waves in the water”. You will have had to have read volumes 1 and 2 of this handbook series in order to understand that sound (vibration) is a language, and aether “particles” hear and respond to that message. They also repeat the message to the next “particle” in the next pixel over from them within the spacetime fabric. Each pixel then follows the command to manifest something that your eyes expect to see and your hands to touch and feel.

Here is just a brief recap.

When a *thought* is generated by a Sentient being, it creates a *spark*. That spark generates a *sound*. The sound is the collective song or melody within a vast symphony where trillions of notes are struck to depict the incomprehensibly-vast message of the entire universe wherein that thought can manifest a reality. Every leaf, every grain of sand and every nuance of what that Sentient being had in their mind is coded into the sonic waves of that single spark which is a **Fire Letter**. The spark is generated by Dark Matter that powers Light Matter, hence why this spark is termed a Fire Letter that holds a universe inside its single snap.

Electroencephalographers who study the waves created by human thoughts have long since proven that each thought you have is a different sound, as unique as a fingerprint. In fact, they’re even referred to as *brain prints*. How could that be unless that sound actually held the notes of differing

ELECTRICAL ENERGY

messages? The answer is, a sound wave created by a sparking thought in your brain would always produce the exact same image in your mind unless it struck different chords within your mental neural network.

All “things” are known to vibrate, not just thought waves. All things produce a sonic signal. No “thing” that exists anywhere is “just there”. This is well known fact, not a postulation. Without this signature, science would be utterly lost in trying to determine how to work with subatomic particles. Vibrations are *messages* we call waves. We see them “move” in an ocean, and we also get to hear their symphony when they crash on the shore. Water waves and sound waves both move in the same way, and both have a sound. There is no such thing as a wave in any form, radio or otherwise, that doesn’t have an audio signature, either to the ear, or outside of that one minute portion of the sonic spectrum. Blades of grass vibrate, particles of sand vibrate, and every single thought that passes through your mind does the same. Were this not so, then your atoms wouldn’t vibrate either. Yet they do.

Every sonic pulse, known as vibration and sound, is well known by science to generate a *color*. You can see these colors generated by any sound or note in a *Cymascope* or *Cymatiscope* (along with their highly intricate, *geometric* patterns they print at the same time). These colors are seen by science under powerful microscopes when dealing with sub-atomic particles. They always relate to what they call a frequency. That frequency is hyper-specific in nature, and when a certain frequency also called a vibration is present

Cheops SPOKE Pt 1

within that particle, they know what type of energy signature that “particle” is supposed to “be” once it has collected other particles to itself in large enough numbers to create something we can see, touch or hear with our senses. Oxygen has a vibration oscillation rate of 8-O-15.999. It can be created in a laboratory by its vibration code or its color code, either one, using nothing but a potato, water or a piece of wood or just air for example. And yes, they “make” oxygen all the time.

Almost all naturally occurring things on Urth have their vibration signature listed on the *Periodic Table*, which tells scientists working with those “elements” how many protons and electrons that thing has, which means the vibration of that object will be this and its color will be that. Vibration, which is color, is the foundation of all particle and quantum science. Without these, science does not exist.

There is no thing within creation or outside of creation that is not energy which can be proven on its face, because there is no thing that does not vibrate. Vibration is movement, and nothing moves without energy. We call one form of energy here electricity, and we call the energy produced from oil, gasoline and wood, fire. In truth, these are exactly the same things, just in different wrapping paper. All of these forms of energy once inverted (turned into *thermal radiation*) are *Dark Matter*. The energy inside the Aniline crystal (called many thousands of different names as well as “quartz”) is both Dark Matter and Light Matter. Man needs to learn how to use Light Matter and put Dark Matter

ELECTRICAL ENERGY

back where it came from, inside the protective cover it arrived in.

IONS AND STATIC ELECTRICITY

Standard Model Science (SMS) refers to energy in multiple ways. While in stasis form, it is referred to as static, and as *electrostatic electricity* (ions, sonic waves, etc.). As soon as energy begins to flow down a metallic conductor of one form or the other, it is referred to as electromagnetic *electrons*. In either form, whether flowing or standing still, it is still called electricity, so keep this in mind. Here is the first deliberately confusing way science hides the fact that there are two different wave forms that energy can move in.

One is *photoelectric* which are obviously photons which carries *no heat* in terms that are significant under nearly all normal use. The other is Dark Matter that always carries heat called *thermal radiation*. The proper term is *thermal electric*, but is usually referred to as electrons or merely electric. Both are “electricity”, but when you are using electrons you are literally playing with fire, because the two sides of energy have just been inverted, exposing the “red wire” to the open air.

CONDUCTORS AND DIELECTRIC INSULATION

Cheops SPOKE Pt 1

CONDUCTOR: Man-made ferro-metals, or certain crystal species with an amount of iron molecules that have had all the oxygen removed are *conductors* of *electromagnetic* electrons. Since the oxygen has been removed (the Light Matter energy wave trades sides with Dark Matter through *parity* called a *magnetic moment*), each particle known as *free electrons* then spin in circles, generating tiny torus fields (magnetic fields) and together form large torus fields of outflowing energy. Each wire turned into a ferro-metal is filled with these free electrons at all times, so when one additional electron is introduced to one end, then the electron on the opposite end will jettison from the wire, because it has now been pushed out like too many water droplets inside a pipe.

Since the ferro metal has been stripped of its insulating oxygen, the surface or valence of the wire can now conduct Dark Matter energy. However, there are countless ions still inside that wire in the center that refuse to join that energy flow, but rather vibrate; continually moving the free electrons along in the direction of the intended flow. So ions literally move or *power* electrons. You can think of a solid table set on a slight angle that shakes, moving peanuts from one end to the other without a belt turning underneath them.

DIELECTRIC: *Dielectric* crystals are known as *non-conductors* of electromagnetic Dark Matter energy (free electrons). Free electrons create an electromagnetic field

ELECTRICAL ENERGY

which is “negatively charged”, so when this field comes into another “negatively charged” field, such as the (-) side of a magnet, it is repelled away. Dielectric crystals automatically *repel all magnetic fields*, as they are already fully balanced in content, needing no additional protons or ions. This is known as an “insulator with a caveat”:

When a powerful electromagnetic charge is placed next to dielectric crystals, its crystal lattice (quantum structure) is subject to distortion from the heat that has been applied. An electromagnetic field (Dark Matter) is directly synonymous with heat, so the lattice bends under this field, which causes the crystal to weaken against the invading Dark Matter waves, which artificially decreases its ability to repel those forces.

The dielectric crystal is the “perfect capacitor”, because it can be used to store more energy this way, then when applying a different current, it suddenly jettisons all the excess Dark Matter electrons trapped inside, such as in the flash of a camera which uses ferro metal as the filament that has been allowed to reach open air (or gasses).

INSULATOR: When crystals are melted down and then cooled quickly, all the millions of tiny individual crystals inside its lattice structure become mixed up, pointing in random directions. When there are zero iron molecules in that crystal, this renders that resulting mass as utterly non-conductive of static electricity or electromagnetic electricity. It is an absolute non-conductor. We call this *glass*. However, as already mentioned, if that glass were melted back down again, and then allowed to cool very slowly, it would become another functioning crystal once again, regardless of how large the melt is. The resulting crystal would be viewed by science as containing no “individual atoms” of any kind, but would be a single, unified *molecule*. More on that later.

POLYMORPHS

Then there are other crystal types that are also considered non-conductors which are “metamorphic” or “polymorphic” that change from dielectric into effectively glass as soon as it is exposed to sunlight. This is known by various names such as *limestone*. While in the water, it is *dielectric* (which might better be called *antimagnetic* or *anti electric metal*), once it is removed and placed in sunlight, all the microscopic Aniline crystals inside then turn into a million different directions and stay there.

ELECTRICAL ENERGY

Incredibly, certain types of stone once taken out of the water will then begin to grow magnetite magnets inside its molecules, which then causes it to conduct energy, direct energy and amplify energy through secondary emissions. It is an extremely unique combination of metamorphosis and the stone type is highly unusual. I think you will come to see this isn't a stone at all, but rather silica wood, which will be covered a bit later. This is known as *Basalt*.

All of these differences in substances play into how pyramids function, so knowing the difference between conductors, semiconductors, magnets, *paramagnetic* and *polymorphous* minerals is specifically germane to this disclosure. If you don't know that "stones" and "rocks" can take different forms all on their own, then you would have no idea that graphite is secretly the exact same thing as a flawless diamond only in different form that now acts completely differently from each other - all while still possessing the *same atomic crystal lattice structure* as each other. Without such knowledge, especially when talking about *ancient devices*, this report will be worthless to you. A person needs to have some idea of what stones really are and what "electricity" really is first. The Temples weren't made out of "rocks" because "*that's all they had to work with, dur dur dur*".

If metals really were the smartest materials to work with, why are there no 5,000 yr-old metal or bronze pyramids? Even mainstream admits to the Bronze Age dating to 3300 B.C. With claimed 400 million-yr old hammers found encased in solid rock, please don't tell me modern man was

Cheops SPOKE Pt 1

the first civilization who knew how to work with metals. Of course, that stone itself could actually be geopolymer limestone concrete as well, you can be the judge of that. The hammer shown below wasn't "melted" from stone into this shape, it was chemically created in a controlled metallurgic processing "bloom" crucible where the oxygen was deliberately removed in multiple, controlled stages in a process that is extremely difficult and technological to achieve even today with modern equipment:



ELECTRICAL CURRENT

The movement of electrical flow is called *current*. This is because electrical flow is in *wave form*, just like water currents; with eddies and other forms of turbulence as well as something we will get into in a moment; frictionless "laminar" movement. Thus, science states:

ELECTRICAL ENERGY

Current is analogous to **water flow**

Voltage is analogous to **pressure**

Batteries are analogous to **pumps**

Wires are analogous to **hoses or pipes**

Unlike water in this analogy, if you cut an electrical circuit, the current will stop because the conductivity in air is very low, whereas if you cut a hose, water will spill out.

CONDUCTORS (“Metal” Equated To Hoses or Pipes)

- silver
- copper
- gold
- aluminum
- iron
- steel
- brass
- bronze
- mercury
- graphite
- dirty water
- concrete

DIELECTRIC INSULATORS (Equated To
Closed Spray Nozzle)

- glass
- rubber
- oil
- asphalt
- fiberglass
- porcelain
- ceramic
- quartz
- (dry) cotton
- (dry) paper
- (dry) wood
- plastic
- air
- diamond
- pure water

**PHOTOELECTRIC FIELD VS
ELECTROMAGNETIC FIELD**

An electric field carries within it a magnetic charge of one either negative, meaning it is carrying energy, or positive meaning it is seeking energy. When two of the **same fields** come close to each other they are repelled. When they have opposing charges, called *polar*, then **energy from the negative field is absorbed by the positive field** which makes them cling together (attraction). In a crystal, the

ELECTRICAL ENERGY

field is referred to as *photoelectric*, or *electrostatic* and in a *mechanically generated* electromagnetic field, it is now “*electrified*” *magnetic*. Both types of fields are “electric” and both are “magnetic”, but only mechanically-generated fields are *electromagnetic*:

- **Electret-Magnetic** is Light Matter static energy (ions)
- **Electromagnetic** is flowing Dark Matter energy (free electrons)

Here is another example of how science deliberately obfuscates the terms. Both are polar **magnetic** energy fields, but only one, electromagnetic, is a *Dark Matter* field, yet they are used as interchangeable in everyday parlance as simply an “*electrical* field”. I point out the very specific differences here, but getting to those differences in an average example in everyday life is practically impossible.

If you take advanced courses on electricity however, you learn right up front that a ***strong force thermal electric field*** is what runs down powerlines, and the ***weak force static electric*** field is largely reserved for microphones and squawking piezoelectric speakers. But by then, you have already begun to learn the special language of science (as an utter misdirection of your attention), so you simply go with their never ending definitions of the principles that lead you further and further away from realizing that this is the same energy wave only inverted, which they will never mention no matter how many classes you take.

Cheops SPOKE Pt 1

An **electric motor** or **generator** produces an **electric field**, but so does a simple crystal or donut shaped granite stone with a hole in the middle that has no moving parts. The difference is, the **motion** generator (referred to as a *mechanical generator*) is using chemically-altered “metal” to mechanically and artificially change parity, forcing electrons into open air, outside of its insulation. This now **inverts** the two waves, pushing the Dark Matter into material form like in an open fire, which always carries a thermal signature (because that’s what fire does). Don’t worry, as this topic will be very clearly illustrated before we are done.

When ions are created, this process involves a spark inside liquid water where there is no oxygen to support that spark, yet the neutrino does so anyway. This means it comes into material existence in Light Matter ion-neutral form, where it is absolutely insulated by trillions of Aniline crystals suspended in amneio fluid water which is a naturally shielded substance against static electrical fields which are considered very weak by electro-standards.

Realize ions always release a *secondary emission* of Dark Matter when passing *through a spark*, allowing the energy to travel into ground, and *ground* is synonymous with *iron+crystal*. Water (liquid crystal) is also considered ground due to the traces amounts of iron minerals it carries. Crystal ion energy is more than happy to come out and play in light form, as long as you ask it to do so through its

ELECTRICAL ENERGY

cellular language, which is through **sound** and **geometric symbols**.

The core-piezoelectricity within crystals is significant; however there are only a few ions that are within the outer valence of the crystal that are “mobile” using our standard methods of tapping that energy using metal wire. As soon as these are “knocked free” from that thin layer of insulation, then they invert into electrons. This is why crystals are used in multiples within a computer or say a battery. Each “cell” of crystal, be it a fraction of an inch or massively huge, will have just a few negative ions that are readily “mobile” in its outer valence bands that will go through a metal conductor. No matter the size. This is because each crystal that is joined together acts like a single molecule, rather than say a million molecules like all other materials when it is scaled up.

In a Tesla automobile battery that uses lithium ions (crystal energy), there are hundreds of individual small batteries inside like 1.5v flashlight batteries that are all hooked up through semiconductors inside (isolated from each other, but still connected in the direction of the energy flow), rather than just one large crystal:

Cheops SPOKE Pt 1

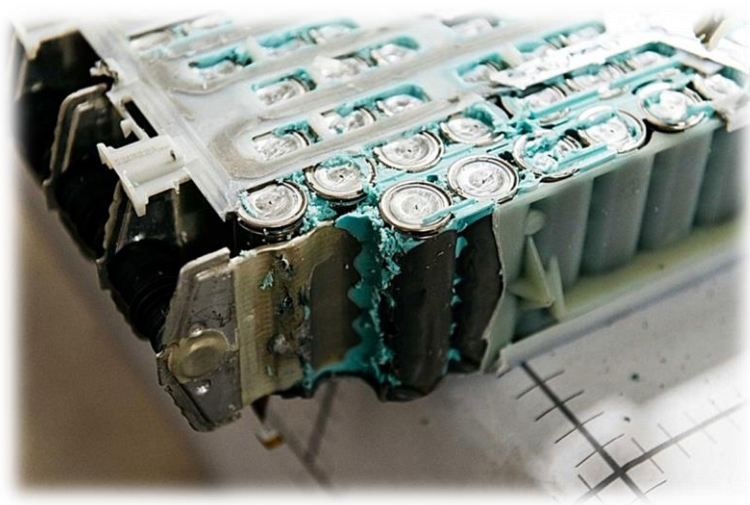

So getting to piezoelectricity is the challenge for our civilization. The answer is obviously the way we speak to crystals. One Tesla car battery would power a city the size of Portland instead of just that one car, if you were able to get to the ions that are held inside their nucleus instead of the 4 electrons in its outer valence bands.

As mentioned, cellular language, or **Keylon** symbol “letters” is the written language of speaking to crystals. This language has been disconnected from modern man for the most part, but the other way of speaking to crystals is through sound. At which time, the magnetic photoelectric field they are happy to generate is *fantastically* greater than anything an electromagnetic generator is able to produce, as indicated by science who is well aware that for every electron that can pass through the outer valence of a crystal, **a hundred times that** in ions are left behind within its **nucleus**. But since that is Light Matter energy, man hasn’t

ELECTRICAL ENERGY

been educated on how to tap this resource anywhere near to the extent of using electromagnet Dark Matter energy. Just keep in mind that *magnetic fields* are created by crystals, just like the torus fields of a mechanical generator. So that energy will function like any sonic energy device; such as a magnetron that uses sound to develop very powerful waves. What it won't do is then provide you that energy to use unless you use sonic, "sympathetic" resonant crystals as your conductor (inductor). We get into that much more later.

ELECTROMAGNETIC INDUCTION

Electromagnetic induction is the transfer of an electrical charge through the air to an electromagnetic conductor nearby (usually a metal wire or a series of metal and crystals called *semiconductors*). Electrical science does not come right out and tell you that electromagnetic conduction is actually *through the air* induction. They say it is "*the transfer of power between one electric circuit and another caused by changes in the magnetic field linking them*", hiding the fact that you have just witnessed a dipole moment where Light Matter energy turns into Dark Matter energy or vice-versa, and that exchange is not through a connection, but rather through the minute airspace between that *crystal* or *crystal composite* and the conductive wire. It is the open air that is required to make this "magnetic moment" happen.

Cheops SPOKE Pt 1

This is the process of sending Dark Matter energy from the torus field created by a **metallic** mechanical electrical generator through a *spark*, pushing it into the other material, which begins the flow of electromagnetic energy. If there is an open-air spark involved in any way that is not absolutely insulated, then you are dealing with *Dark Matter*. Electrons (tiny sparks) are seen in the outermost valence band (shell layer) of a *wired* electrical circuit. Inside the photovoltaic (crystal) at its nucleus there are “sparks”, but while inside that crystal they are fully insulated. One is fire (the tiny “electron” sparks), the other is cold fusion. We will see a picture of this “insulated, cold fusion light” a little later on in this report. These are called ion beams in electrical science.

As you are well aware by now, electron is another word for Dark Matter and is used in science to describe the force of *atoms* (hence why they call their own special species of being Adams/Atoms). But as soon as that atom pairs with a second atom to create a molecule, then all of a sudden the strong force is now gone and is replaced by *ions*. This is because now they are *insulated* and thousands of times “stronger” than when they were in individual atoms and exposed to open air.

Again the deception that electrons are merely particles of energy jumping from one atom or molecule to the other, when in fact, actual electrons are *always* “free electrons”. “Free” meaning exposed to once again, open air. As long as you are aware of this one thing, the rest of the puzzle will fall into place how it was the Kybal has managed to hide

ELECTRICAL ENERGY

the fact that mankind has been using Dark Matter energy all along.

The “insulation” of ions is the creation of the symbiotic (magnetic) torus field between two “paired electrons”, which then causes that crystal to become photoreactive, or respond to sunlight. The sunlight then adds the “oxygen” factor to their equation that “free electrons” don’t carry. Therefore, you can state with certainty that there is no such thing as paired electrons, only paired ions, but I am getting ahead of myself and will cover that in more clarity under the many sections in which we are going to cover superconductors. You will have a whole new respect for superconductors before we are finished with this disclosure.

Electromagnetic induction is the transfer of energy that deals with conductive **metals** that expose the electron to air somewhere in the process. It makes or creates more free electrons in this process, but while that spark is within that torus field, that energy is danger to every DNA cell of the human body as well as all other life on the planet. It was meant to remain totally shielded except in only the rarest of cases where the balance between too many anion ions are exposed in open air that must be brought back into insulation through lightning or similar.

ELECTROSTATIC INDUCTION

Cheops SPOKE Pt 1

Electrostatic induction is the process of sending Light Matter energy through the air in a *resonant frequency* to a crystal or through another *dielectric insulated capacitor* nearby. This energy can also be directed using flexible strands of *optic fiber* or *protein filaments* (hair) as you will see later.

Hair is not what you think. Secretly hair is actually running sonic resonance chambers that your crystalline body uses as its *harmonic resonant inductive couplers* to the aether. They can be thought of as very narrow, but incredibly complex **magnetrons**, but I don't want to get too far ahead of myself. The "holes" you see in the cross section of a hair strand below are literally "ion fuel lines" for want of a better term:

ELECTRICAL ENERGY

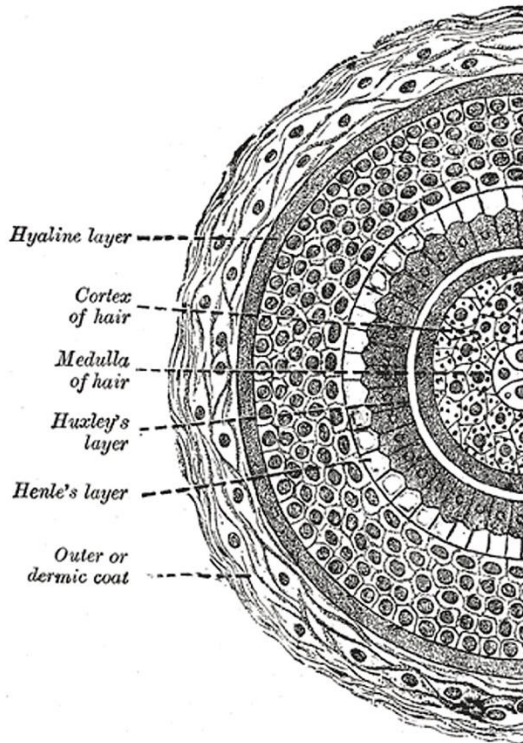

Like twisting copper wire into electrical cords, those dielectric, flexible sonic resonance chamber strands can be braided to any length. **Optical fiber** is also made of dielectric material (silica) and transfer only light waves as well. Hair is made out of the very same material called “protein” which is actually crystal silica. We’ll see an example of hair being used as Light Matter energy “wires” shortly.

When working with natural energy conductors (photons/ions) such as **crystals** which is just another term

Cheops SPOKE Pt 1

for **silica** as mentioned above, they act like **non-conductors** of electromagnetic energy (think *force field*). This is because the two are two different tones of the same harmonic frequency like a tone and overtone. However, since they are the same type of thing, energy, then ions will function like electrons do as just mentioned above, while going through **amplification**. Such as inside a sonic resonance chamber or across the *dynodes* of a *photomultiplier* we will be getting to.

Ferro-metals (conductors of electromagnetic electrons) however, will dramatically slow this energy flow, or offer a repulsion to impede that transfer. There are only a few ions hanging in the outermost valence band of a crystal, allowing metals to easily “knock” them out for use as Dark Matter, so the “*crystal field*” is far weaker than an electromagnetic field, so overpowering Light Matter energy is extremely simple to do while using metal wire. As soon as you get rid of the metal, then the crystal field carries the potential of pure photons, which is scientifically *immeasurable*. However, the way science refers to photon energy while applying it to electromagnetic Dark Matter mechanics, it seems benign under most applications. You will see that it has always been the presence of ferro metals that has been stripping mankind of its easy access to energy thousands of times greater than what we have had access to.

This is where energy in electrical science and particle physics does the sleight of hand maneuver and claims that electrons are electrons and different minerals all have 3 or 4

ELECTRICAL ENERGY

or 8 etc. protons (cation ions) at their core, which equates to how many potential electrons are powering that “ion”. So we could go through all sorts of math and equations here to explain potentials, only to find that genuine ion energy has been filtered through Dark Matter mathematics, not Light Matter mathematics. This is because in the end, all the energy today’s devices work with at the end point are using electron Dark Matter to power that device, even though they use ions throughout the entire process of building up to that final moment where they turn energy inside out once again to use their machines.

The fact is, there is a watershed of energy held inside the core of crystals for each 3 or 4 electrons science is able to scratch out of that mineral for their Dark Matter agenda, but in the process of creating energy, it is always **core ion energy** that is multiplying that electricity in numbers that are literally unthinkable, and certainly not limited to the puny numbers afforded by electrons.

For the academically indoctrinated physicists reading this paper, it will be difficult to see beyond that elaborate programming to understand that the power of a photon is unlike the power of a mere electron. Even attempting to convert the power of a photon into words used by science, such as Joules or energy packets, the conversion is always spoken of in electromagnetic terms, not Light Matter terms. So there are literally no formulae to express anything more than in terms of mere volts or Joules; in other words, Dark Matter electrons.

Cheops SPOKE Pt 1

By simply realizing that energy is alive and aware and each spark inside a crystal represents at least one photon which is code word for awareness and therefore the power of the aether itself, you will begin to realize that only Dark Matter energy is limited to “the speed of light” or “the limit of energy”.

You are about to learn, or relearn perhaps, what is called *network covalent bonding*; or the phenomena of certain particles that when they are physically combined, such as placing one stone on top of another stone, those two stones now become in quantum terms, one stone. This is the foundation of Partika energy where 1 plus 1 equals 3 equals 1. Or rather, 1 plus 1 equals 3 in “mathematical” terms. And that extra “1” we just picked up from that simple multiplication, when it comes to aether particles, is the god particle I call aether. It is the power of all things, not just 2 particles.

Sure, there is a quantum to Scalar Vibrational Mechanics; where a spec of mineral has a different signature from a spec of another type, but when you are talking about energy itself, you are never, ever, talking about particles. You are always, 100% of the time, talking about god. And just like that one stone stacked up on top of another becomes 1 stone in molecular physics, the aether is *network covalently*

ELECTRICAL ENERGY

bonded with all other points within all things in manifestation. This is called the *unified field*. When the power of intent (aether) is applied to physics, then there is no such thing as the speed of light and no such thing as limitations. There is only the speed of light when you are dealing with Dark Matter that is exposed to open air. By merely going back to Light Matter energy, you are then surrounded by laws of physics that does not resemble those of Standard Model Science.

SECONDARY EMISSIONS

Take very special note of this section, as secondary emissions isn't a minor issue; we are talking about the production of energy at a magnitude that can be as high as what had already been there before or more, now coming merely from the action of friction alone, like shuffling your feet on the carpet.

This multiplication of energy happens with each surface that either an electron, or an anion ion run into, so this is the **single biggest secret involving energy there is**. When energy "particles" strike a planar or arched surface that is angled to deflect it to strike another at the precise degree, it turns 1 ion into 4 (or 1 electron into 4). A third surface increases them to 8. And by the time you run them over just a few more surfaces, you now get *a million ions* or *a million electrons*. All completely for free and in an unlimited supply.

Cheops SPOKE Pt 1

Bang, bang, bang = \$\$\$.

Whack a crystal gently with a hammer and it produces secondary emissions. \$\$\$.

Squeeze a crystal and it produces secondary emissions. \$\$\$.

Sing to a crystal and it produces secondary emissions. \$\$\$.

You get the idea.

When was the last time you heard about “secondary emissions”? Exactly; never.

Crystals are “free money” in terms of energy that you must pay for, but that energy they produce has been hidden from your view and replaced by the vastly inferior Dark Matter we use today that burns your fingers the moment you try to access it.

When working with Dark Matter electrons, you will reach a certain point where no matter what you do with that energy, it will melt or dematerialize the “matter” it is applied to, stored in or handled with.

This is because Dark Matter is the essence of **antimatter**.

When working with ions, you never reach a point where everything just implodes, because it isn’t based on open flame, but rather on insulated “valences” in crystal-speak.

This means with electromagnetic energy you will never develop a device that will interact with matter on an interplanetary level with a single “laser”.

At least with our minerals here in the 3rd dimension.

But with ions, or pure energy, you can change matter at any distance from your arm chair.

ELECTRICAL ENERGY

This is because secondary emission “dynodes” can be placed in any number you want, and you will always get a quantum doubling of the energy *with each strike*. Millions, billions and trillions of trillions of volts, Joules, or photons can be produced in the blink of an eye, as they can move without regard to “time” as you will see later. However, when you are dealing Dark Matter energy, that energy must reach its destination carrying its thermal signature, or it is now void, whereas Light Matter energy always carries its energetic signature above and below the maximum extremes of temperature that limits electromagnetic signals.

You can think of this like a horse appearing each time one bumps into another one. But since you can't see it, and science doesn't talk about it, it seems like this is nothing. Yet it is through this one act that electrical science is able to generate the highest levels of power known to man outside of outright nuclear detonation. It only takes a few “bumps” to have an entire herd of horses when there were only two to begin with.

Any surface will do for this; but certain shapes force energy to bump into a lot of others before going on to the next set of surfaces as shown in the first infrared photograph at the beginning of this volume where Cheops' edges and peak was bright red and orange, and the rest of the pyramid was blue. And since the ions in each surface never deplete of these excess energy packets, as they are literally manufacturing them, this means every surface can be thought of as an endless supply of “free” electrons, or of

Cheops SPOKE Pt 1

“free” ions, depending on if that surface is “metal” or if it is dielectric crystal.

When energy passes through metal while going back to ground, or changing from an ion into an electron, it creates an exponential increase in Dark Matter energy that is released into the surrounding atmosphere. This is *radiation* as we have just covered. If it is ion energy leaping into another ion molecule or crystal, or going back to *insulated* ground (soil surrounding the metals), this simply places more anion ion energy into the air or insulator called *ionizing*. The difference between ionizing the air and electrifying the air, is a fully shielded ionic release emits paired ions that are in balance, whereas an electromagnetic field electrifies the air with free, unpaired electrons. One, the ion, is a molecule where the blue wire has the dominant frequency, the other is an atom where the red wire has the dominant frequency. Both carry two harmonically connected waves.

When a lightning bolt of very high *anion* (negative) *ion* charge strikes ground and creates a spark (because Urth has iron content), this creates a momentary exposure of Dark Matter that you can see and of course, hear and feel that massive vibration. However, Urth, while being a conductor, is also full of crystals where that energy then immediately goes into for storage, which is why Urth is always a “ground”.

ELECTRICAL ENERGY

The human body is also a “ground” for such energy as well, because the body produces a small amount of magnetite iron which continually circulates through every inch of the body, as it is the nucleus of each blood cell. If that cloud were lying on the ground when it discharged its energy connecting a direct ground to the soil and not allowing the ions to reach exposure to the air (a gap between the cloud and the soil), there would be no spark (that you could see or be **negatively** affected by anyway). Open sparks electrify the air around that area, just long enough for the surface of Urth to collect up all those secondary emissions in the rocks, trees and the rest of the landscape in moments. If there are too many sparks, then those free electrons travel in the wind until they can find a home. This is what happened to the air around Giza during the days of the Pharaohs and again in the modern world, especially in cities and under powerlines.

However, when water evaporates from the ocean, it turns cation (positive) ions into anion ions naturally, which ionizes the air, also producing secondary emissions in clean, non-sparking, photonic form. The difference between lightning strikes and ionization is like the difference between a mountain brook and the Pacific Ocean. So the symbiosis, if left to mother nature, works elegantly. Saturating the skies with millions of tons of weaponized metals in chemtrails and filling the air around us 24 hours a day everywhere we go with electrons from electromagnetic motors is an utterly different thing.

Wiki: Secondary Emission;

Cheops SPOKE Pt 1

*“Secondary emission in physics is a phenomenon where primary incident particles of sufficient energy, **when hitting a surface or passing through some material, induce the emission of secondary particles.** The term often refers to the emission of electrons when charged particles like **electrons or ions** [notice they use both terms; **electrons and ions individually, meaning these are two different things**] in a vacuum tube strike a **metal surface**; these are called **secondary electrons**. In this case, the number of secondary electrons emitted per incident particle is called secondary emission yield.”*

[Now note carefully]

*“If the secondary particles are **ions**, the effect is termed **secondary ion emission**. Secondary **electron** emission is used in **photomultiplier** tubes and image intensifier tubes to **amplify the small number of photoelectrons** produced by **photoemission**, making the tube more sensitive.”*

*Did you catch the sleight-of-hand-there? Where they just got through telling you that ions are one thing, and electrons are another, yet they are both working inside of a **PHOTO** multiplier? It is **critical** to point out that photomultipliers (which we are coming to soon) work initially off of **only***

ELECTRICAL ENERGY

photons (meaning only photons can begin the process), and produce electrified (inverted) photons/ions which are then technically electrons.

The photons are turned *into* electrified or electromagnetic electrons (unpaired) only when they are forced across a **metal surface** entering that photomultiplier and then kept in **Dark Matter** form all the way through by using metal plates instead of using dielectric conductors such as crystal. The same amplification will also occur if those photons are allowed to remain insulated by striking crystal dynodes rather than copper. It is the language that science uses to misdirect engineers to focus their attention solely on electromagnetic radiation energy in order to keep your world **saturated in radiation**.

STATIC ELECTRICITY AND NEUTRINOS

Inside a neutrino are three “flavors” according to science, or three different potential states of existence. Neutrinos are entirely stasis energy, and all three of these flavors; the **electron**, **muon** and **tau** are therefore each neutral. However, once they strike a proton (this is a cation ion), they make the transformation between totally stasis energy that can pass through most materials of virtually any thickness without slowing down, and into 3D energy that now comes into “atomic” form.

Cheops SPOKE Pt 1

These three flavors have been individually identified as then becoming **electromagnetic**, or they can become **neutral** exhibiting no charge of any kind, or they can produce a **massively huge** charge fantastically higher than that of the strong-force electron found surrounding or “holding together” an atom. You can read this to mean they can become Dark Matter energy called the “strong force”, they can go into stasis, or they can become what science calls the “weak force” found in piezoelectricity.

Yet when we go down into sub-atomic particles to find out exactly which forces power 3D atomic energy we are really talking about, suddenly the picture changes dramatically, showing that the Dark Matter “electron” energy is simply nothing like that of piezoelectricity in actual power. But since we don’t try to use piezoelectricity with the same pure enthusiasm as we do electromagnetic energy, we don’t see this in the text books.

The neutrino, which is an invisible “force wave” running in the frequencies of gamma rays, are the most prevalent “thing” within Urth’s atmosphere, and are deposited by and through the sun. When one of the sub-atomic particles of the neutrino changes **parity** from positive to negative for instance, its *antiparticle* (its Dark Matter shadow self) changes at the same moment to its opposite parity as well as shown in previous chapters of DTH, called *neutrino oscillation* or *quantum superimposition*. All three flavors of the neutrino have an antiparticle side, and when any of

ELECTRICAL ENERGY

them change in parity, they **all change together**, which means they are locked hip-and-waist to each other and all agree they are now Light Matter “ions” (active), “protons” (asking for the energy to become active) or “neutrons” (neutral). Or they are any one of those turned inside-out into Dark Matter versions of their flavors.

While in neutrino form, prior to their transition from aetheric energy to 3D atomic energy, the neutrino is strictly an ultrasonic sound wave, expressing no light of any kind that you can see with the naked eye. However, because it vibrates, we absolutely know it’s there. That vibration is what strikes a proton to produce “ion babies” as observed in a *Bubble Chamber* such as at CERN or other laboratory. This is why this “really small particle” is considered a fermion (firm ion) with half-integer spin. In every respect the neutrino carries within it the power of the photon that we see in the form of illumination once it has transitioned into 3D existence, and vice-versa. You will see that a neutrino is merely the same exact thing as the photon before we are through, only in two different flavors.

A neutrino when collided with an antineutrino to find out what’s inside only produces light, all the way down through all three flavors. Even though we can’t see them, they are considered **photon rays**, merely in stasis (neutral). In order to understand the neutrino, these particles have undergone considerable research to determine what their flavors mean within 3D atomic terms. Here is how they break down:

Cheops SPOKE Pt 1

- The **electron neutrino** is the “neutralizing” flavor of the *invisible photon neutrino wave*, equating it to place a neutrino into stasis, or, into a **neutral neutrino just like an atomic neutron**.
- The **muon neutrino** is the flavor of a **Dark Matter electron**;

In 1962, **Melvin Schwartz** of *Columbia University in New York City* and *Brookhaven National Laboratory* (BNL) found the muon created what is called in an atom, the “strong force”:

*“To detect neutrinos, the researchers built a 10-ton spark chamber consisting of 90 1-inch-thick aluminum plates separated by 3/8-inch, gas-filled gaps. As neutrinos flooded through the chamber, one would occasionally **strike a proton** [this is known as a **neutrino event**] in an aluminum nucleus, producing a neutron and either an **electron or a muon**, according to theory. This charged particle would ionize the gas, creating a **visible spark** track when high voltages were applied across the plates.”*

The above experiment established that the neutrino while in **muon form** acts exactly like the energy from electromagnetic generation from free electrons

ELECTRICAL ENERGY

(Dark Matter) striking open air (gas-filled gaps between the aluminum plates).

- The **tau neutrino** is the flavor of **electrostatic piezoelectricity** (found in crystals), or better known as an **anion ion**, or *ion beams* carrying “**3500 times the power of an electron, and 17 times the power of the muon**”;

In 1997, **Firmilab** found in their *Donut Experiment* that the tau not only exists, but functions exactly like a **photon** or a photo reactive **anion ion**:

*“The tau lepton leaves a track in the layers of emulsion, just as **light leaves a mark on photographic film**, but in three dimensions”*

Vittorio Paolone from the University of Pittsburgh

The experiment above left no doubt that a neutrino when in **tau form** acts exactly like ions which is *photoelectricity* that emits from the center of pyroelectric (quartz) crystals.

The fourth, or “missing” neutrino flavor that is still vigorously being hunted down as I write this report is thought to carry the essence of the **cation ion**. But that “flavor” will never be found in the neutrino, because this is the task of carbon that is bonded with oxygen only after neutrino energy has transitioned into 3D matter form in an ion. Carbon is the cation side of ions, and neutrinos are the

Cheops SPOKE Pt 1

anion side of the “magnetic attraction and repulsion” that makes everything function within our holographic world.

Keep in mind, there is only **one type of neutrino**, but it is broken down into these 3 different categories of what it will do once it has made the transition from neutral to ionic energy. It is turned into an **electron by striking protons held inside Redoxed metal and creating an open-air spark**. And it is turned into an **ion by striking a proton held in emulsion (liquid crystal water) so the spark remains contained**. “Redoxed” metal was never meant to cover any surface of the Urth to generate free electrons, but the planet is literally covered in water so neutrinos can always create insulated ion energy.

So how do we further know that the strong force and the weak force are from the very same neutrino energy waves which are in fact differing states of stasis energy held inside of crystals?;

*Wikipedia: **Electroweak interaction:***

“Sheldon Glashow, Abdus Salam, and Steven Weinberg were awarded the 1979 Noble Prize in Physics for their contributions to the unification of the weak and electromagnetic interaction between elementary particles.

....if the universe is hot enough (approximately 10¹⁵ K, a temperature exceeded until shortly after

ELECTRICAL ENERGY

*the Big Bang), then the electromagnetic force and weak force merge into a **combined electroweak force.***”

Which means flatly, that when both are heated to the same common energy zenith, the strong force **disappears** entirely, leaving only **aether piezoelectric energy** which is **Light Matter**. Which means that Light Matter is the parent, and Dark Matter is the offspring.

A *ground* is, as the name infers, Urth’s body, which is made up of a very large amount of organic iron, but it is also made up of a much higher amount of crystal as well as just mentioned. The term “ground” in electrical-speak means a **dielectric insulator** (which is crystal), and iron is the way (conductor) to get electrons back into that insulation.

Water is **highly grounded** when connecting to Urth’s body in a lake or pond, as are trees and people, especially if they’re not wearing insulating shoes. This is shown by the fact that water molecules are known as **neutron cation ions**, equated to **protons**. Air is known as “active” **anion ions** (often incorrectly equated to free electrons). Since the human body is up to 75% water, that means your body is equated to a **body of water**.

THE GOD OF WATER

*The most ancient, antediluvian god that has ever been found in the oldest of artifacts was known as **Wawwu**, the god of **water** and is still worshipped in secret with every letter **i** typed by all peoples of the world using Latin-encoded alphabets:*



Even in Japanese logographics that have been sent through the Latin International Phonetic Alphabet, the original, ancient symbols remain. Here is the

ELECTRICAL ENERGY

letter i where the bowl of water is now a crooked line rather than a dot:



Her symbol is also encoded into every form of written and spoken communication around the world through Romanization. She is literally known secretly as the “I” in I AM. The letter above when sounded out in Japanese is also spoken “I” in ai.

*She was then, and is now, the highest Urth-bound deity of all time. The dot above the lower-case letter i are her peoples; the “bowl of **droplets of water**” she holds above her head. Her name has changed many, many times since the earliest days, but no matter what she is referred to, you will always find her bowl of water and her slender image holding it up.*

Later when we cover the symbols used to hide the true identity of the Sumerians who were responsible

Cheops SPOKE Pt 1

*for rebuilding the pyramids and who also wrote all the Romanized alphabets used today, you will see her dish of water worn as a crown. The dish represents you bound to the Urthly realm as her children made out of **amneo** water.*

STATIC ELECTRICITY AND NEUTRINOS CONT.

In neutrino experiments, scientists have noted that when the parity conversion occurs in the flavors of neutrino electrons, muons and taus, a spark is released called *radiation*. This is the spark that I talk about that is emitted when electromagnetic energy returns to stasis that we call a *static electrical discharge*; when we reach out to grab a door handle and get zapped. Neutrino conversion tests (when creating an ion in a bubble chamber as covered in earlier chapters), happen inside salt-baths which is heavy water in extremely high levels of salt. This is typically pure Deuterium placed inside a large piece of salt that has been hollowed out, so the only thing present in the chamber are the type of particles that neutrinos “mate” with while creating ion energy: empty cation ions called **protons** in saline (which is referred to as *liquid crystal*).

Neutrinos can also convert into Dark Matter energy in a bath of pure crude oil as well, which is Dark Matter energy that is surrounded by its own insulation, but is much less insulating than water. These oil particles were never mean

ELECTRICAL ENERGY

to interact with the surface evolution, so while inside Urth's core they remain perfectly insulated and safe. But by simply striking a match next to them, they readily burst into flame and expose their energy to the open air. As soon as that air is removed, the flame inverts back into shielded form once again.

The salt bath neutrino event creates a tiny *explosion* and in that instant a dual-wave ion is born, or an ultra-powerful electric particle that will now be able to carry usable energy to say, your cellphone from the lithium-ion crystal battery inside or power the entire planet through the dispersion of rain. This energy is carried solely by microscopic Aniline crystals in protective wrappers (silica valence bands).

We have surrounded ourselves with de-oxygenated, inorganic “metal” everywhere today (*emulated iron explained in the METAL section*) so, the spark your finger emits to the metal doorknob changes the stasis *static tau ion electricity* in your body in *parity* while going through that conductive material, sends out the secondary emission Dark Matter electrons, but immediately changes parity once again, and back into ions once it reaches the wooden door, or completes its path to ground through the hinges, through the structure and all the way back to Urth. But while that spark is in open air, it is only then “radiation”.

Ions are meant to be in a state of shielding, not simply exposed like fire. Fire is extinguished *not* by the *liquid* of

Cheops SPOKE Pt 1

water; it is only extinguished by blanketing it with the crystals held by the water that instantly absorbs the ions into their valence. If this weren't true, and liquid really did extinguish fire and not the crystals inside, then tossing flour on a flame wouldn't extinguish it. But because that flour is filled with tiny dielectric Aniline crystals (cation ion state), it absorbs the energy back into their proper containers.

So it is important to realize that the energy inside of a crystal, or energy inside water, which are both static electric or static *electrolytes* are still "ions", just as the air is filled with around you. In "dry" form, such as the flour, or in "heavy water" form, such as Deuterium, they are cation ions/protons which can be thought of as **sponges looking for ion energy which will be surrounded by insulating oxygen** once it is refreshed. And in "wet" form as in a living plant or "fresh water", they are active anion ions already insulated. That oxygen and energy is immediately imparted to heavy water by exposing it to the sun, because the liquid surrounding the crystals is photosynthetic (another word for oxygen), the "magic" that allows the sun's invisible waves to transform into **active** ions. An active ion is called an **anion**, which is equated to a negative (-) *outgoing, free or moving* charge.

This is why even though Deuterium isn't filled with negative ions while at the bottom of the ocean (it is in **neutron ion state** which is equated to stasis neutral until it has been exposed to a little oxygen which then turns it into **proton state**), it is considered the most powerful energy carrier there is, because it will transform into

ELECTRICAL ENERGY

overwhelming volumes of ion energy the moment it is brought to the light of day we call open air.

It is Deuterium water blasted onto uranium-235 crystals that creates energy in nuclear reactions to give you an idea of just how much energy potential heavy water carries. All that uranium crystal is doing is imparting massive levels of oxygen anion ions that flood that heavy water that causes this intense energy.

Flour will also become full of ion energy the moment it is exposed to water and sunlight, but once that exposure has been made, the oxygen in the water **that has already been exposed to the suns waves**, insulates the energy being transferred into the flour. So it **will not burn**. If you fill a room full of **dry** flour, or dry wood dust in the air and then strike a match, that room will go up in a **powerful** explosion because the air (oxygenated water) is too thin to insulate that much energy being transferred all at once from the air ions into the flour crystal “sponges”. In that instance, the parity change from non-grounded “air ions” into grounded state cannot be suppressed by only the existing moisture in the air which causes it to combust into an **open-air fission reaction** instead of remaining merely a tiny spark.

CATIONS AND ANIONS

When a neutrino particle strikes a proton, as observed in a Bubble Chamber as just mentioned (and as happens all day and night in the core of Urth where heavy water and Urth's blood called crude oil fill up its core mass), it produces a physical, hard-coated **neutron ion crystal**. That ion crystal is just like a battery with a positive side and a "negative" side. The positive side is a **cation**, and the negative side is an **anion**. These two change **parity** whenever they go through a *dipole moment* as mentioned.

When the neutrino is first transformed into an ion, it is in a neutral, resting state, but is made up of both sides of its dual-wave form, giving it the potential to take any form it wants to. Its dipole moment is triggered by **the frequency of sun waves**, turning the ion from a **neutron ion** into an **anion (-)**. We call this evaporation, when in truth, it is the powering of the atmosphere called *ionization*.

After coming into birth in heavy water and then absorbed by some animated life form in the Urth or in the seas, it depletes much of its energy, so now the ion is in a proton state known as a **cation ion**, forever looking for more energy. Cation ions usually are static, or in a grounded, or anchored-to-Urth state, such as in trees, rocks, animals etc. These are sponges, or the empty side of crystal energy forever inviting outgoing energy to come in. **It is the essence of magnetic attraction**. Every material thing within existence is powered by this attraction.

ELECTRICAL ENERGY

When a cation ion has been fully refueled again, instead of attracting more anions, it repels them, because it has now become an anion itself. **This is the essence of magnetic repulsion.** Every material thing within existence carries this trait as well. When these two essences are held inside of an iron molecule together, then that magnetic attraction and repulsion is broadcast outward to affect other iron molecules, hence, a magnet. We are able to “see” and measure this attraction/repulsion when it is inside a magnet, but we don’t notice it when it is in any other form, such as crystals, grass and people, so we dismiss this as not being a real force. It is.

Some minerals, such as graphite, are always in an “empty” cation-ion state and only serve to call in ions just to immediately kick them out the other side again. In energetic terms, these minerals are literally black holes. This is the big secret that science and fake gods reserve only for themselves to access far more energy than any magnet in the world can possess in its one little set of valences.

If you knew that merely by placing a “permanent” cation ion substance (like the antithesis of a permanent magnet) next to a highly-active anion ion substance, you would generate massive amounts of free energy without having to deal with physical magnets getting in your way, you would have such generators in every single hair dryer, smartphone, radio and cigarette lighter (as well as every

Cheops SPOKE Pt 1

other device) in your world. Think a large quartz crystal sitting in the middle of a pile of wood ash for example. And instead of rolling on rubber wheels, your cars would levitate, as would your hospital gurneys, shopping carts and anything else you have to drag against friction to get from one place to another.

Anion ions, or “free ions” in the air are carried by the wind across all surfaces of Urth, constantly recharging all the cation ions calling out to them through friction known as **SET**, or Static Electrical Transfer. It is insulated by the moisture surrounding the anion ion, so the transferal between the anion and cation is seamless. When that transfer happens, the energy being placed into the cations is instantly being *generated* by the sun’s waves which cause **photoelectric secondary emissions** which are roughly equal to the same energy transferred into the stone or the tree (or person).

Sometimes the free ion energy in the air builds up to a point where in order for the atmosphere to remain in balance, they build up in a cloud formation (the gathering together of high volumes of anion ions), which causes the air to “break down” its reluctance (resistance), which causes a lightning bolt to send the excess energy back down into Urth’s ground all at once. This is the momentary release of Dark Matter energy into the open air.

ELECTRICAL ENERGY

Conversely, if there are too few anion ions in the air (called “air pockets”, and can also take the form of low lying fog), Urth will send up a ground-to-cloud lightning bolt to refresh those ions so they remain fully charged. Again, this causes a temporary inversion of the two waves within the ions, where there simply isn’t enough moisture in the air to continue to shield Dark Matter energy from exposure. But as soon as the transfer is made, the cation ions in the air, land and water surrounding that bolt are immediately absorbed once again, making the air safe for human and animal life. In each instance this always creates **brand-new** secondary emissions equal to the exchange, so there is never such a thing as the Urth or air running out of energy because neutrinos never stop blanketing the planet and every molecule within the atmosphere.

CRYSTAL PHOTOVOLTAICS

You can think of crystal, which is always vibrating, as raw photoelectric energy. Or as the **device** that turns *light* into *sound*. Modern science turns that sound into an energy flow using electromagnetic induction using the Dark Matter side of magnetic attraction/repulsion and sending it across a conductive metal surface to our toaster to turn it into thermal radiation because it kills humans. *Voila’*. The same thing can be done to coax the energy out of the crystal by using musically-generated sound that can then resonate the **frequency of fire** without generating any thermal radiation while traveling in open air and into another crystal surface. That crystal receiving the signal will now get hot, but not in

Cheops SPOKE Pt 1

a form that will burst out into flame when something comes into contact with it like a red hot metal wire will do.

Take for example the ceramic space heater that uses crystal to warm your area instead of wires. While man does use conduction in the process of getting that frequency to the ceramic crystal to vibrate in the signature frequency of fire, it is still using ceramic to process the heat. And ceramic is self-insulated. Dark Matter energy transforms at the ceramic back into Light Matter which is not going to cause a fire or irradiate your DNA unless it is being *artificially exacerbated* by Dark Matter electrons. The wires going to that ceramic are still carrying electrons that are flying around within a few feet torus field that will still microwave your genetic codes, but not the ceramic itself.

People were told as soon as televisions made their way into homes not to sit too close, because the radiation from the screen was harmful. And today those children who sat right in front of them anyway make the claim they are just fine after all, while wearing glasses because their eyes don't work right anymore and are undergoing chemotherapy for their cancer they don't bother to mention.

We can harness photonic energy simply by gathering the thermal radiation (heat) absorbed by a crystal that is sitting in the sun (the crystal is actually generating the heat, not "radiation" from the sun which does not exist as explained in a moment under **cosmic rays**) by placing an *oscillator*

ELECTRICAL ENERGY

between it and a transformer, which turns the piezoelectric/photoelectric ultrasonic waves emitted from the crystal into *flowing* energy. Just like when a quartz crystal (silica) is squeezed by pressure down at least 0.01% of its original size, the invisible waves from the sun activates or releases ions inside which we call static electricity, but is really ultra-fast oscillating sonic sound pulsations. However the photonic waves must transfer its energy from photonic light waves into the crystal first, as in a photovoltaic crystal cell:

PHOTOVOLTAIC

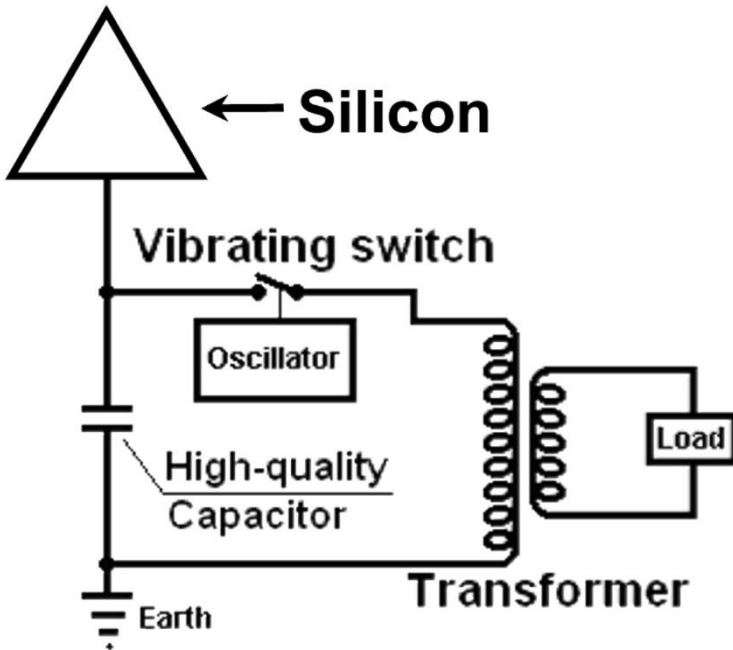

Cheops SPOKE Pt 1

Imagine this entire structure above is made of different stones and the wires are more stones or flexible hair, wool or optical fiber to see how you can eliminate the metal. The sun waves enter the photovoltaic crystal that is tuned (cut) to the frequency you are seeking (notice the pyramid shape). This is not by chance, as this is the physical symbol of Light Matter Energy), so the oscillation that transfers that energy is already at the right *harmonic resonance* of your receiving device.

The oscillator that is in line between the silicon crystal above and the ground is also a crystal, as is the “High-quality Capacitor” by the way. It is bringing cation ions up from Urth and adding it to the silicon crystal that is bathing in sun waves, imparting anion ions. Sun waves increase ions inside crystal and also releases piezoelectric energy naturally, no pressure involved. As mentioned, the square pyramid above is the natural shape of magnetic energy, so maximum energy is deposited inside any *square pyramid shape* through *Keylon Command Codes* as explained in a bit.

CHAPTER 6

DARK MATTER ENERGY



Energy is a sound and color wave that has an *anti-wave* as mentioned above, or *two signals* that counter-rotate around each other at all times. Like all waves, there is an anti-wave called Dark Matter, and there is the primary wave that is Light Matter (which makes up the things we see, touch, hear, etc.). Think of the *blue wave* below as *Light Matter* and the *red wave* as *Dark Matter* which is typically invisible:

Cheops SPOKE Pt 1

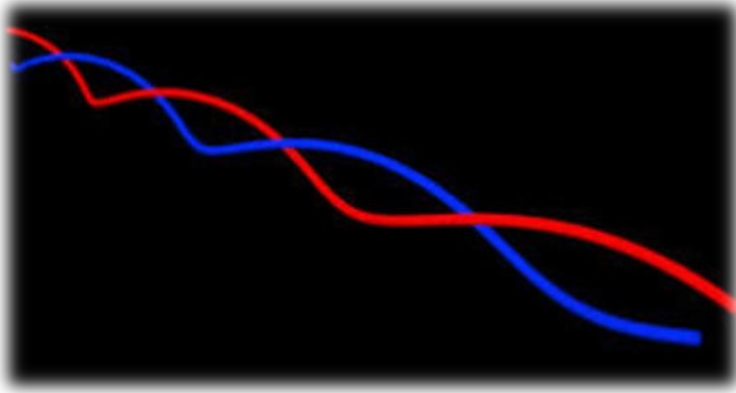

The light energy signal manifests *visible spectra* and the dark energy *powers* that process. The two are inseparable, but the two can be exchanged, where the dark energy (raw energy) can be seen with your eyes and touched with your hand, such as when lighting a match. Again, this is known as quantum superimposition. Now that bright red match just turned *black* and you see above its color or *essence* of Dark Matter in manifest form as a *red flame*. This is energy that is dangerous, as witnessed every time a forest fire breaks out and destroys a thousand years' worth of life form growth.

Dark Matter energy is necessary to keep the balance within a material world, but it is not supposed to be toyed with. Light Matter energies are the toys given to 3D man to play around with as a medium in which to express your creative abilities without ending your evolution. Cave men (you when you were first establishing the 3rd Dimension) found out quickly that if they left their camp fire unattended, their

SCIENCE OF THE STONE

world would quickly turn black around them, taking with it their means to sustain their lives.

Dark Matter is attached to *all forms of energy*. It is the shadow that lies beneath you as you walk in manifest form, and it is the shadow that always accompanies what we call electricity. It is the “antiparticle” to every “particle”.

RADIATION

Radiation is a term used to explain invisible waves that are the result of *nuclear decay* such as emitted by the sun, or other things that do not carry a noticeable magnetic signature, such as a light beam or laser beam (both photonic energy). Nuclear decay is another word for destruction and is used as the standard reference to very harmful and even fatal frequencies emitted by nucleus crystal energies that have been released into the open air and outside of their protective casings.

You are told that the sun releases this energy that is constantly trying to kill all life, but this is simply not true, as you will soon see. That is a cover story in order for the dark forces to perpetuate the notion that you are absolutely surrounded by radiation from your very sun that provides the sustenance for your life to encourage you not to go outside where it's incredible healing properties can be accessed. It is also perpetuating the idea that if you are

Cheops SPOKE Pt 1

surrounded by radiation anyway, then radio waves, microwaves and electromagnetic waves are perfectly fine.

Even if an element (thing) doesn't have a "weight", let's say, like the letters on your computer screen, they still carry a *scalar Dark Matter signature*, because nothing can exist in the 3D spectrum, not even printed letters, without some form of energy holding it in place. Radiation is another word for **black-body radiation**, or radiation **that emits from black (and grey) sources** such as black holes, black paint, graphite, or anything that is "black". Black is merely a *shade of grey*. More on that later. For now, just realize that Dark Matter energy does have its place in your playing field, but it has been secretly brought into your every moment to keep your Avatar from reaching more than only a few years of life, for very important reasons for their agenda.

Such radiation signatures are called *scalar waves* because they are simply there and can be sensed but have no "mass". Science calls this *magnitude*. That side of the two waves of energy can be measured and mapped with a scalar/gauge boson pixel *number* within spacetime, or with a *spectrometer*. In other words, they can tell you, using a scalar field, exactly how strong and where that "magnitude" is located in correlation to other things seen and unseen within the fabric (pixels) of "everything" called *spacetime*.

SCIENCE OF THE STONE

Radiation is another word for **Dark Matter**. It exists, but unless it is released to the air, is invisible. Or less-than visible, such as your shadow below you. It has no weight, no distinguishable magnetic push or pull, but it is still there. Through this, even if it isn't casting visible light, science can determine where photon/ion energy is, even if that energy is working as the **reflection** or **shadow** of things that can be visibly seen, as they can *hear it*, because it is a *sonic vibration*. That vibration is created from the sympathetic resonance created between the waves seen previously in the blue and red illustration.

On a stringed instrument, if you pluck one string, the string next to it vibrates in sympathy to find a harmonic resonance between them. The Light Matter wave is always vibrating, so the Dark Matter wave will forever vibrate as well, as long as the Light Matter "life force" is supposed to be in existence. Only the thoughts of a sentient being can generate the blue light wave of Light Matter energy, and only members of the god family are able to bring that life into being. Your thoughts can turn it on or off. All you need to understand is you are from the god family, so it is your thoughts alone that support reality of any kind.

While at the same time, science can also determine that radiation is the dangerous side to photons that can burn your fingers. They tell you the sun emits these dangerous waves instead of letting you know that the only heat you experience on a sunny day is from the microscopic crystals in the air that are responding to this signal, and releasing warmth and oxygen to keep you alive. They also equate

Cheops SPOKE Pt 1

sunlight “gamma rays” to the radiation being cast off of electrical generators and microwave oven signals. However, both of these mechanically-generated waves carry an *electrified*-magnetic field with them (unshielded thermal electron energy).

There is no (measurable) electromagnetic field from sun waves; however gamma rays do have this EMF field, which are credited to “*solar radiation*”. But evidence shows that what is called *cosmic rays* from incoming debris into Urth’s atmosphere are responsible for gamma rays. This is because that debris was created by using Dark Matter pure-energy weapons over many millions of years of destroying whole planets within this solar system which eventually make their way into this playing field through the veil. It is much easier for them to tell you that gamma rays originate from the sun so you avoid these healthy frequencies that your skin and body needs, so you can personally help finance the weaponized medical industrial complex.

Thus, you are convinced that the sun is actually a giant burning ball of fire in space, even though there are no hydrogen particles to support any kind of fire there at all. Like sitting in front of a camp fire, cosmic radiation is also *thermal radiation* that can burn you, but it isn’t coming from the sun. As mentioned, once you believe that the rays of the **sun** are guilty of creating “*background radiation*”, then the radiation being emitted all around you by EMF devices will seem harmless. You may not fully grasp this now, but by the end of this report, you will see the clear difference between radiation and photonic waves.

SCIENCE OF THE STONE

Heat from ultrasonic Dark Matter microwaves only comes into play when the food inside the oven is subjected to sound waves that are created by a magnetron that is made out of ferro-metal (such as copper), so the emitting wave force is carrying an *electro* (*metallic* electric)-magnetic field with it. A microwave oven could also emit sound waves that wouldn't destroy DNA, but then that frequency wouldn't be generated by a metallic "conductor" (but rather think ceramic, silica, calcium or quartz), and would be carried forward by ions instead of electrons.

IONIZATION VS IONIZING RADIATION

This is the expose' of the diabolical sleight-of-hand of Dark Matter Science, which is my term for Standard Model Physics. As just covered, waves from the sun are not "cosmic rays". Cosmic rays are ionizing radiation waves that come into Urth's atmosphere from left-over Dark Matter radiation emitted from celestial wars, while waves from the actual sun itself are ionizing waves.

You: What? Didn't you just use the same exact term two times in a row?

Me: No.

What I said was science tells you sun waves are ionizing radiation, when they are the opposite, ionizing waves.

You: So how on Urth could these be two different things then?

Cheops SPOKE Pt 1

I'm glad you asked. Science has engrained into your consciousness that radiation is the same thing as sonic waves. The waves from the sun are strictly ultrasonic sound waves that do not carry any radiation. A radio wave such as celestial waves might *also* carry sound, but a radio wave is actually a *radiation* wave. As in *radio-active*. The very word radioactive comes from disassembling organic matter through inorganic processes to expose “chemicals” to open air. It comes from the word *Radon*, not from “radio” like the one now playing in the background. The Sumerians brought their clever techniques of manipulating organic minerals into Dark Matter weapons and now call them chemicals. What they really are is imbalanced, distorted molecules that were never intended to be fractalized away from their *partnering elements*.

We will cover more about Radon very soon, so you can see why it is that all things “radioactive” are extremely dangerous, because they come from a crystal that was not organic to this planet. And at its very core is the mineral Radon. When clinically-insane warmongers blast Deuterium over one of the elements of this crystal, it creates a “radioactive” (**radon-active**) “nuclear” (the nucleus of atoms) reaction, literally splitting atoms and elements such as hydrogen away from their partnering elements which then produces a **thermonuclear** reaction. And take special note, that the very word used just now (thermo) is the actual term that science uses to describe any electromagnetic energy signature. Not all electricity is **thermo**, but all Dark Matter electricity is. Thus, even

SCIENCE OF THE STONE

though electricity doesn't actually come from Radon, all electricity used in this civilization has been tagged back to Radon as a *nod to the gods* that brought this weapon here in the first place, because as soon as electromagnetic electrons are released into open air, their frequency triggers the destructive release of atomic minerals inside of Radon. Radon *kills*, period.

A mere sound wave is a totally different thing from a radio wave. And again you can see how desperately confusing and contradictory that appears, since you have been taught to equate sound and radio as the same things. Sound waves do not carry radiation when you speak or yell, yet sonic waves sent through the air below, within, or above your audible spectrum *carrying an electromagnetic signature*, do. One is organic (from your mouth or from plucking a plastic guitar string), the other is a mechanical (artificial intelligence) creation that is powered by open-air "free electrons". Think *fire* traveling through the air.

Radiation is Dark Matter. A camp fire is **radiating** heat and will continue to do so as long as there is fuel. It can travel by crawling forward, devouring more fuel (oxygen content in trees, dry grass, etc.) as it goes, but the moment you introduce a sonic wave behind that fire (such as wind which is simply ultrasonic sound waves), now that fire can travel WITH the sonic waves. And now at breakneck speeds. Radiation doesn't travel all by itself without help from oxygen (Light Matter). When fire reaches the ocean where there is very little oxygen inside those still-stasis cation ions, it simply goes out.

Cheops SPOKE Pt 1

Sound waves are Light Matter which is a combination of oxygen (energy) and sound (the message or Command). So science makes the terms for Dark Matter sound like their terms for Light Matter to trick you into not noticing the very clear differences between the two. One keeps you alive, the other kills you.

Ionizing radiation causes “nuclear decay” that destroys your DNA, because you are a *living crystal* (grown from the Crystal Seed Atom at the core of your myocardium or *heart*). When science talks about “nuclear decay”, they mean the ions that inhabit the core of each of your crystal DNA cells at the center of each droplet of your blood or of any other material thing. Electrons travel only in the outside valence of crystals, but when a cell (a crystal) is overwhelmed with too much Dark Matter, it implodes that cell itself, causing a collapse of the crystals’ structure at an atomic level called a nucleus, or “nuclei”. Hence, *nuclear decay*, or the destruction of crystal energy.

Science uses the term “ionizing” to indicate a negative-pairing of free electrons back into ions (which is a highly positive thing for your health), but then they turn right around and use the term “ionizing radiation” to indicate that the air is full of Dark Matter electrons, which has been shown to be the most destructive and deadly form of EMF radiation there is when it has nothing to do with “ions” the way they use these terms in all other references to energy. Ionizing is equated directly to great health. Ionizing

SCIENCE OF THE STONE

radiation is equated directly with death. The only difference is they add the word radiation to the second version of ionizing (seemingly invisibly), making it virtually impossible to tell the difference between the two by casual glance.

You *want* to **ionize** your space around you, but the last thing you want is to be within the field of **ionizing radiation**. Again, like often using the word electron when speaking specifically about ions, they simply substitute phrases and modify them ever so slightly to make you throw up your hands and say *forget learning any of this noise*, because they are self-contradictory, just like their innumerable religious texts. And this thrills them to no end to trick you into blindly following whatever it is they say, no matter how idiotic or ridiculous it might actually be. Like the Urth traveling at “67,000 MPH” when all actual playing fields are as stationary as Mt. Everest. The rest of the “planets” that remain stationary to our view over thousands of years are *satellites* encircling that playing field and holographic projections (a combination of the two). You look right over the fact that 67,000 happens to reduce down to the number 13, or their signature symbol.

Deadly microwaves currently generated by *mechanically-produced Dark Matter electrons* that create a *Dark Matter torus field* using *Dark Matter metal sonic resonating chambers* in standard magnetrons are **weaponized sound waves**. As they emit from that magnetron, photomultiplier, cyclotron, etc., they are pushing Dark Matter through the air that carries this electromagnetic torus energy field that

Cheops SPOKE Pt 1

can now fry biological matter in seconds by *ionizing radiation*, not *air ionization*. **Ionizing radiation** is creating more Dark Matter energy, whereas **air ionizing** is **diffusing** Dark Matter by turning electrons back into paired, **balanced**, ions:

*Wikipedia: **Ionization**; Production of ions;*

*“**Negatively charged ions are produced** when a free electron collides with an atom and is subsequently trapped inside the electric potential barrier, releasing any excess energy. The process is known as **electron capture ionization**.” [The binding of two particles to produce energy is the actual definition of **nuclear fusion**, keep this in mind.]*

This paragraph states in cloaked terms that balanced ions are produced when a **free electron** is **absorbed** by an atom. **Atom is another word for proton**, or an energy state that is seeking anion ions (the outgoing “negative” energy emitted from an ion). When the Dark Matter electron strikes the atom and is absorbed, the **secondary emission** from this collision produces a second “energy”, which is an **anion ion**. **The two** now form together as a single, negatively-charge, dual-wave **ion**. This is “*ionization*”.

Now we take a look at the **completely different explanation** of **ionizing radiation** that clearly shows that this is a totally opposite inversion of energy now called

SCIENCE OF THE STONE

radiation, and carries with it the **radioactive danger** sign

immediately within the definition, :

*Wikipedia: **Ionizing Radiation**;*

“Ionizing radiation is radiation that carries enough energy to liberate electrons from atoms or molecules, thereby ionizing them [WTF?].

*Ionizing radiation is made up of energetic subatomic particles, ions or atoms moving at high speeds (usually greater than 1% of the speed of light), **and electromagnetic waves** on the high-energy end of the electromagnetic spectrum.” [The separation of particles to produce energy is the actual definition of **nuclear fission**, keep this in mind.]*

The message here is only clear if you understand that electromagnetic fields must be present in order to perpetuate the chain reaction of Dark Matter fission. **An open fire will cease to burn if it doesn't have a weaker electromagnetic field to feed off of.** An electromagnetic field, which is absolutely not an electrostatic magnetic field, is synonymous with *radio* and *radioactive radiation*. And yes, your radio is radioactive and the waves coming in and out of it are radioactive, because the entire system is designed around radiation that destroys DNA.

In particle physics-speak, what you have just read directly from Wikipedia is the creation of two different things

Cheops SPOKE Pt 1

called the same thing to your programmed mind. When a thermonuclear warhead detonates, it creates fission and leaves radioactive isotopes in its wake. When energy is amplified through a superconductor, it creates cold fusion and leaves no damaging isotopes behind.

This is the simplest possible way to explain the difference between ionization and ionizing radiation. But you won't find this paragraph under Wikipedia or in any other scientific report, as it is merely the plane truth. Are you beginning to see the pattern here? If there weren't a very complex and sophisticated collusion to hide the truth in scientific text, then there would be no such thing as what we have just witnessed.

REDOX METAL

Metal is not an organic thing. Copper, silver, iron, gold and other "metals" must go through *Redox smelting* in order to remove all the oxygen out of those organic crystals before they will conduct Dark Matter energy. Again, science uses terms virtually indistinguishable from opposing definitions to each other to explain things are that absolutely not synonymous, yet used exactly this way. **Smelting** is not **melting**. It is melting inside a crucible specifically *to remove oxygen* which always produces what is called *bloom*. That bloom "slag" is the liquefied crystal valence layers that once held the oxygen within that outer valence band.

SCIENCE OF THE STONE

With the oxygen now eliminated, science can use more of the remaining crystal valence bands to conduct a handful of Dark Matter “electrons” across their surface while leaving countless ions inside the crystal as the vibratory “engine” that moves them down the line. This is a lot like using an Urth mover the size of a building to carry a teaspoon of dirt across the building site. It is oxygen that gives the breath of life to man and oxygen that gives the breath of life to crystals to hold the shape and function they were meant to hold. Without oxygen, the crystal has no way to insulate the overabundance of Dark Matter waves flooding over its body.

In case you thought that iron comes out of the ground in handy metal bars, this is natural *mirror iron* crystal while it still has its oxygen:



Oxygen is a secret word for **insulation** as we have already exhaustively covered, and crystals, according to science, are “*entirely oxygen throughout their crystal lattice*” (quantum makeup) as well as stating “*a crystal is effectively the solid form of oxygen*”.

AQUALUNG

On October 3rd, 2014, Christine McKenzie of Syddansk University announced she had found a

SCIENCE OF THE STONE

*way to make cobalt crystal granules produce pure, breathable oxygen, allowing scuba divers to breathe underwater. **4 days later**, known-disinformation monolith SNOPEs immediately responded, already armed with the information that Christine was wildly mistaken (as all accredited professional scientists are when stumbling across important new findings).*

*In just **96 hours** the pressure placed on the University of Southern Denmark by the backers of SNOPEs (commissioned by Facebook founder Mark Zuckerberg as an official source for authentic intel), had already convinced the institution to say that when she said that a **spoonful** of cobalt crystals would turn water into oxygen enough to breathe underwater, what she really meant was **10 liters**. And of course she mistook 1 spoonful for a wheel barrow full, since most scientists don't really pay much attention to actual measurements as a tedious, never ending demand to keep their facilities from being blown into the next star system.*

*Once again the machine kicked in to dispel any hope of humans advancing in their quest for higher standards of living by people who generally do not know anything about most of the subjects they comment on. In fact, David Mikkelson, founder of SNOPEs, according to his **about me** page has never worked outside of computer programming in his life, attaining a B.S. degree (yes, you do know what*

Cheops SPOKE Pt 1

*that stands for) in computer science alone, and now has managed to single-handedly become the one authority for truth on all subject matters from the proper dispensation of female breast milk to the truth behind terrorist attacks and has now become the field leader in Quantum Crystal Science, able to recreate the precise volume of cobalt crystal it would really take to breathe underwater. And do so in **4 days**.*

Like the rest of his exposure to the world of “all things”, according to his “about me” page he spends all his free time “sitting in at board game conventions”. Just like Neil Armstrong and Jacques Cousteau did. Described as a money-hungry, conniving playboy looking for a fast buck who spent \$98,000 on prostitutes by his wife according to documents in divorce court in 2017, Mikkelson went on to immediately marry his long-time professional escort and adult film star girlfriend he had taken on trips around the world according to reports. And now she works side-by-side Mikkelson, doling out investigative facts on everything from microbiology to liposuction. I don't see why anyone would ever question what it is these two have to say about advanced particle physics technology.

And when SNOPEs gets around to debunking the contents of this report, I am sure he will be just as qualified to speak on the matter as he was on how many cobalt crystal granules it takes to replace

SCIENCE OF THE STONE

breathing tanks which obfuscated the point of the entire announcement; that crystals are oxygen. By depicting McKenzie being so wildly incapable of telling a spoon from an ox cart, in one fell swoop he managed to destroy all her credibility as a scientist after a lifetime of dedication and study while dismissing the notion that you can just hold a small gadget between your teeth while underwater to remain there for hours, as has been depicted in many films and books that were assembled as actual disclosure required of the invader races in order to continue their mass-brainwashing of the human evolution.

As has been explained, unless they show you the truth in one form or the other, the aether will not allow their continued occupation of mankind, as it goes against the fundamental ethics of manifestation. As long as you are offered free-will choice, you are allowed to be led down any path you choose. By posing such advanced use of crystals without making it seem like a joke, McKenzie was flying in the face of very powerful entities who make certain you never stumble across higher knowledge, especially on the battlefield of crystalline technology.

REDOX METAL CONT.

Cheops SPOKE Pt 1

Besides being *oxygen capacitors*, crystals are also known as “dielectric non-conductors” of electromagnetic energy. This is not a coincidence, as crystals are the totally-insulated package that photon energy comes wrapped in, which relies on the properties of oxygen to safely contain Dark Matter in its nucleus until it is absolutely necessary to enter the air space.

When “metal” crystals are weaponized by removing all the oxygen from iron, this now floods the outside surface of that resulting material with electrons, which makes Dark Matter energy travel through their *outer shell* with little resistance. However, within each fraction of an inch those electrons travel in this totally manufactured manner, they conflict with countless ions that are resisting them from entering into the core of the crystal, because it is already balanced with the correct amount of Dark Matter and Light Matter waves. That resistance is obviously friction, which creates heat; hence the term “thermal electricity” is used to describe electromagnetic electrons, not “static electricity” which moves with little or no heat.

The human body operates the same way all organic life forms do; on static electricity. But since Dark Matter electrons make up a portion of the waves that course through its delicate electronic system, then merely by overloading it with excess electrons, what was meant to remain in balance now works to destroy its DNA similar to a forest fire. This is known as nuclear fission, or fire that feeds off of all forms of matter to remain ablaze.

SCIENCE OF THE STONE

You DO NOT breathe oxygen; you breathe ions that are *insulated* by oxygen so your sensitive lungs don't receive levels of electricity they are not designed to handle. If you were only able to breathe "air" and not liquid, then no person would have ever been born from a womb filled with amniotic fluid. Amniotic fluid is the same thing as "oxygen" which higher beings refer to as amneo which includes everything from heavy water, sea water and fresh water all the way up to "air".

These levels can be thought of as *different voltages* of energy. Try to breathe straight water and you immediately die because there is too much raw cold fusion per oxygen insulation for your lungs to manage. In fact, the water doesn't even need to actually enter all the way into your lungs for the electric current to cause you to "drown", explained by medical science as *pulmonary edema*, **not** drowning. Your body runs on ion energy insulated by oxygen, and the only place oxygen is generated is from water exposed to sun waves or the *frequency* of sun waves.

You are a surface-Urth biological entity. Anywhere sun waves are unable to refresh the insulation in the water in the air, you "suffocate". This means that it is impossible to drown or suffocate, but it is totally possible to fry your electronics by

Cheops SPOKE Pt 1

overpowering or under powering your electrostatic device.

Here is the explanation of the process of Redox:

*Wikipedia: **Redox** (short for reduction–oxidation reaction);*

*“Redox is a chemical reaction in which the oxidation states of atoms are changed. Any such reaction involves both a reduction [**of oxygen**] process and a complementary **oxidation** process, two key concepts involved with **electron transfer processes** [dipole inversion of ions to electrons]. Redox reactions include all chemical reactions in which atoms have their oxidation state changed; in general, redox reactions involve the transfer of electrons between chemical species.*

*The chemical species from which the electron is stripped is said to have been oxidized, while the chemical species to which the **electron is added** is said to **have been reduced**. It can be explained in simple terms:*

***Oxidation** is the **loss of electrons** or an increase in oxidation state by a molecule, atom, or ion.*

*Reduction [**Redox**] is the **gain of electrons** or a **decrease in oxidation** state by a molecule, atom, or ion.*

*As an example, during the **combustion of wood**, oxygen from the air is reduced, gaining electrons*

SCIENCE OF THE STONE

from carbon which is oxidized. Although oxidation reactions are commonly associated with the formation of oxides from oxygen molecules, oxygen is not necessarily included in such reactions, as other chemical species can serve the same function. The reaction can occur relatively slowly, as with the formation of rust, or more quickly, in the case of fire.”

It is critical to understand here, that the word oxygen and oxidation are two different words with two different meanings, even though it seems like anything oxidized would have more oxygen. Again, this is a highly orchestrated collusion to hide the actual truth. **To oxidize** is to rust or corrode, leaving a chemical reaction on the surface of that thing that shows that the once active oxygen of that mineral has now been **spent**, leaving a carbon mess behind. Carbon, ash and coal are the result of oxidization, which is a **Sulphur acid**.

One is oxygen, the other is oxidation .

Did you catch it? The sleight-of-hand once again?

With the exchange of one letter, y to i, science is able to use the same word to mean two opposite things and then use them as if interchangeably while explaining something to you which is how they have managed to fool even the

Cheops SPOKE Pt 1

brightest minds on the planet. In Occult teachings this is known as *Trompe-l'œil*, or the *trick of the eye*. Even though they used the word oxidation to explain the Redox process, they immediately went on to explain how in a fire, oxygen from the air is reduced, when they just got through explaining something completely different from a chemical process. What they were trying to say is that by reducing the oxygen from iron, they reduce that iron's capacity to generate oxidation, thus totally obfuscating the entire process by misdirecting your attention. This way you won't figure out that this is the process of **weaponizing iron** to magically create "metal", something that *does not* exist in nature.

SEMICONDUCTORS OF DARK MATTER

By now you are well familiar with what a conductor of electromagnetic flow is. We most often use copper, but other ferro-magnetic artificial metals can make an even superior connection, such as gold and silver. But silica, or *crystal*, is also a conductor as well. It just conducts far less flow of the type of energy Dark Matter Science is trying so desperately to use. And within this balanced form, the ions work differently than they do in a conductive metal.

Silica (not to be confused with "silicon" which is "doped" – raped- silica) is produced by the human body. It makes up the many layers of your skin and other elements of the body and is what our hair, bones, teeth and our fingernails

SCIENCE OF THE STONE

are made out of. As covered earlier, these can be thought of as our electrodes or the points on our body that more readily interact with the energies in the air called ions. These are dielectric calcium crystal that are resistant to electromagnetic flow unless they are moistened by the water in our systems which makes them much more of a Dark Matter conductor than say a dry salt crystal (which would be a cation ion). Therefore, they become a sort of link between ions and electrons, similar to a semiconductor.

Your skin is moist, so it acts like a cation ion, or water where it is photo reactive to sun waves, producing oxygen when you are outdoors. Your “dry” crystals, such as hair and nails also act as a cation ion, or “cathode” which easily sends and receives energy, due to the fact that it is virtually void of moisture. So you can equate your nails and hair to graphite or carbon. Your body requires salt to survive, but does not manufacture it on its own, so you must ingest sodium with your diet in order to make your blood an *electrolyte solution*, which now powers your electronic system. This means that you are always calling out for negative ions, and the sun is always sending those frequencies out to it.

Since you are supposed to maintain an alkaline electrolyte system to properly power your device, the weaponized medical industrial complex tells you to avoid salt at all costs. Of course they do. Table salt is indeed poison, but organic sea salt is not.

Cheops SPOKE Pt 1

Learn the difference and look for aluminum (Redoxed Dark Matter metal that destroys the brain) that has been added to the first one to see why avoiding that is indeed wise advice. No cow ever licked a salt block long enough to give themselves a heart attack. Think about it.

You are a *semiconductor cathode* by the mere fact that your body is made up of crystal, but it also produces iron and is always hosting an electrolyte solution (your blood). So you can conduct electromagnetic waves, and you can conduct pure ions. In real terms, that means you could hold a crystal in your hand and send out Dark Matter sparks from your fingertip, or you could pass through ions to a resonant harmonic conductor or harmonized crystal device through your fingernail. Science needs to use a semiconductor in order to get energy out of crystals and then turn them into Dark Matter energy to power that device.

Iron is the most precisely equivalent mineral that would describe in electronic terms, what the human body is. It acts as the go-between for Dark Matter. When you receive a zap from static electricity or from an outlet, your body automatically processes that energy into your crystalline lattice and stores it as energy. Or it sends out its excess through your same cathodes.

SCIENCE OF THE STONE

This means simply that the human body is in fact, a Dark Matter Avatar design, not entirely a Light Matter biological entity. This is why you maintain a “temperature” which is your thermal signature. However, while it does actively utilize the “red wave” of Dark Matter, inside you are a fully insulated crystal. The trick is the liquid crystal electrolyte of your blood that allows you to function as a semiconductor.

Of course using water or blood inside a constantly-hot computer is complicated, so science creates semiconductors out of crystals by injecting cadmium molecules into other piezoelectric crystals to create “holes” in what they term as *silicon*, or silica with more cation ions (like protons) inside which continually call out for more anion ions to come in and refuel their capacitors. Cadmium is exposed, unbalanced minerals called chemicals created by an alchemical processes developed by Hermes and taught in Occult sciences. The destruction of crystals on a cellular level to create such chemicals is destroying the human genome as we get more deeply into as we go. “Chemicals” are responsible for most of the ills suffered by this evolution.

Cadmium for example, just this **one** chemical out of more than **1000** that computer component workers are exposed to, and what everyone using a computer are then exposed to, is known to damage the lungs, cause renal dysfunction, immediate hepatic injury, bone defects, hypertension, reproductive toxicity, teratogenicity and is a *known* human carcinogen for the lungs and leads to prostate cancer. You

Cheops SPOKE Pt 1

can multiply that by a factor of one thousand just to get that smartphone into your pocket that sits next to your reproductive organs so it can irradiate your sperm and ova (the eggs a female is born with and marinate in radiation until such time as one is brought to life that now carries all the genetic distortions caused by electromagnetic fields and fields of toxins). Radiation has been shown in medical science to cause genetic “scars” on male sperm that then carry those distortions forward into the egg that is also distorted, resulting in a child that is born deformed from the very outset and will battle with immune deficiency all its life.

Dark Matter energy transfers through semiconductors more readily because semiconductors have a small quantity of iron content in their makeup as compared to completely dielectric crystals. While the semiconductor resists Dark Matter energy more so than metal wire, the semiconductor “sings” or vibrates at a certain oscillation which allows scientists to impede or amplify the movement of the electrons more precisely than simply using copper, silver or gold. Semiconductors are the very backbone of solid state circuitry. Before this, a computer the size of your wrist watch today was once the size of a large room where vacuum tubes regulated energy transmission.

In SM science, superconductors function within a 2D world that is either up, or down, rather than in all directions such as in 3D ferro-metals. Not surprisingly, the crystal lattice within crystals is bidirectional by design in the same way, to allow this unobstructed, 2 directional flow. But since

SCIENCE OF THE STONE

crystals are organic, and designed to support life, they don't work the same way that Dark Matter materials do, and do not need to be taken down to a fraction of a degree above absolute zero Celsius in order to bring energy through their valence. When science finally realizes this, they will see that the crystals all around them are really superconductors, a topic we are about to get into very soon. Of course advanced science as used in thousands of black operations around the world have known this for 100 years or more, but their internal data reports don't make it into surface Urth scientific magazines.

Semiconductors are the *bridgeway* science uses to beat energy out of crystals, forcing them to process Dark Matter. Something they were not intended to do, but through a loophole, the dark forces have found a way to do just that. Inside every portion of a crystal are ions filled with energy, and that energy is constantly sending out a pulsation that resonates with all life on the planet. It is the natural circadian heartbeat of Tara Urth and that purr or heartbeat is a living entity.

It is the aether itself that lives inside of crystal, referred to as *the force* in the documentary *Star Wars*. It will do anything for you that you ask, as long as you are speaking in the cellular language of crystals (life), and you are asking it to remain in balance to support all life. What it won't do, without being beaten into submission, is provide the power needed to harm any part of creation. It *is* creation and is not interested in destroying itself, in whole or in part.

Cheops SPOKE Pt 1

Cellular language is vibration, sound. And vibration can be generated by opening your mouth and speaking, thinking a thought that creates a spark, or writing down your thoughts into a symbol or series of symbols. Each one vibrates scalar (unseen) command waves authored by the aether. Aether is another term for the whole body of god, of which you are one fractal. You are about to learn that even symbols create sound when we get into *Aperiodic Scalar Optical Wave Fields*. In every instance these sounds are in the form of a song that resonates with itself in a melody that makes that sound unique, much more so than a fingerprint. It is the language of crystals because crystals are the carriers of the *commands* (intent) of the aether.

You can think of inorganic, scientifically-created **semiconductors** pretty much the same way you think of a wife-beater. They intend to have their way, whether anyone is singing or just screaming. Organic semiconductors are certain types of crystals, just so we have our terminologies straight. One is *silica*, the other is *silicon* (which you can remember the difference easily, since silica turned into silicon is just that, a con).

A mechanically standardized and weaponized mineral compound of piezoelectric quartz crystal that is infused with exactly 4 electrons inside its usable *conduction bands* typically referred to collectively as a valence. These are not organic beings; they have been pounded and formed into shape deliberately out of balance, as will be explained.

SCIENCE OF THE STONE

Science knows that their creation has innumerable organic ions inside, but they are only concerned with the 4 of them that have been turned inside-out and repelled to the surface of the crystal where they can skip over that nucleus of ions by applying an electrified field at one end, pushing the electron down to the other.

All the minerals and chemicals on the *periodic table* have been reduced down to their own unique number of potentially easily-released ions held in their valence that can be turned into electrons. Hydrogen has 1 and aluminum has 13. In fact, you can think of the many different types of minerals in your ground, water and derivatives of the same, as “different thicknesses of wire” in the parlance of solid-state electronics.

When scientists force other minerals into the geopolymer resin composite (powdered stone mixed, melted or smelted together inside a liquid glass shell) of the “standard” silicon crystal that has 4 *standing electrons* that are “ready for service”, this is called *doping*. I am not making this up. Like a *Mickey Finn rape-date drug* entered into the lady’s glass, these other minerals have either 3 or 5 or more standing electrons at the ready, which produces a vacuum for electrons to flow into, or an overabundance for them to flow out of, which forces the ions into service once they are shocked into action and connected together with Dark Matter metal.

Cheops SPOKE Pt 1

Chemicals are solid, liquid or gas forms of radioactive materials, because that composite material has now been broken apart on an atomic level, exposing living organisms to quantum particles no longer in balanced form. On the order of a *taser* or *cattle-prod* in so many words (keep in mind, crystals are just as alive and aware as you are). This is called “genetically modified” (GMO) in simpler terms regarding health. The semiconductor is the standardized *white canvass* that transistors, diodes and triodes are painted onto in more layman’s terms regarding electronic devices.

Each *mineral element* (which is code word for types of crystals or “chemical elements” derived from the same) on the periodic table, vibrates on a constant basis, which sings the song of each of their different characteristics they are holding the form of. In other words, they are all factually alive which can be proven with simple air ion meters and spectrometers. Each one’s vibration sings a different song, but they are all keyed to the same scale as each other, so their songs all harmonize when the right crystal is placed next to it. Or grouped together to create a very complex symphony. Since crystals all share a base pulsation, which harmonizes them at a quantum level, different mineral elements are able to speak to each other at that beat while integrating their own “composition” into the collective symphony, adding “flavor” to the resulting effect.

Combining different crystals together can produce effects that have been used in ancient cultures for thousands of years that have never been seen in modern times. This was

SCIENCE OF THE STONE

actually a very common practice using materials we don't think of as so much crystals as we do different types or species of hair. Strands from certain animals and humans can be inserted down the core of a simple stick of wood to interact with that soft crystal (the wood) that can be used to do many unique things. Those "magic wands" were depicted in the series Harry Potter as being extremely unique where a wand merchant might have 10,000 different versions in stock and the "magician" (educated person) would know which one resonated with him once he placed his hand on it.

The staffs used by the Pharaoh's court magicians were actually made out of crystals that would rearrange themselves, depending on the intent of the magician and then hold themselves together solidly for use. But since such things haven't been seen openly for thousands of years, we call them fables today. They are not fables, as explained to me by my contact in person.

Academia, while teaching the sciences of the dark-force to human slaves, uses a specially coded lexicon that is designed to confuse at every possible turn. There is no better example of this than in the terms *positive* and *negative*, as elaborated on in previous chapters. Each time I attempt to learn how another Dark Matter principle works, I run into the exact same problem every time trying to understand how it is that electrons are always the "particles" that *move forward* (the free-flowing energy itself) are considered *negative*, and why they are carrying a negative symbol. And how it is that empty spaces inside a

Cheops SPOKE Pt 1

transistor or diode that are “calling to” those incoming electrons are called both positive (and also a *proton* and *protein*) and they carry a plus sign symbol when they are in fact, empty or low on energy.

This is because Dark Matter energy is the mirror of Light Matter, so the symbols naturally reverse. My contact refers to Urth as the Chimera Reality, or life through the looking glass.

Black is factually white and white is factually black and I can prove it, but that is another topic for another report:

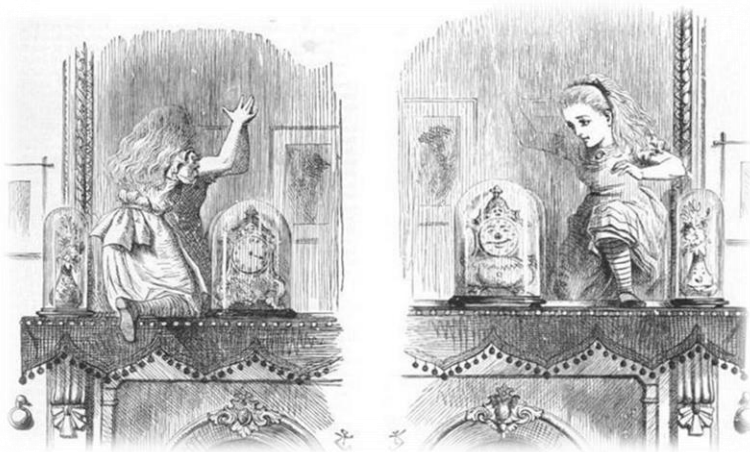

SCIENCE OF THE STONE

The *diode* is the basic functioning heart to a *semiconductor* in its simplest form. It is the science of manipulating crystals into becoming interfaces for the escape of Dark Matter into the open air as partially covered in our previous section we will look closer at now.

In the graphic below, you will see how energy flows in and out of this diode, along with the terms DM science uses. The diode has a wafer of crystal on the left that is designed to be lacking in electrons at all times, as already explained.

The red circles are called *holes* by science, and also as a *proton* which you know to actually be a *cation ion*, where the term “cat” comes from as in “wailing like a cat” seeking a mate, as it is always “empty” of anion ions. The crystal on the right is designed to be over-full at all times, making it bursting at the seams to get rid of some electrons. That crystal will never be depleted, due to the way it was made, so it will forever be a “full tank” with *no space at the inn* for incoming electrons:

DIODE

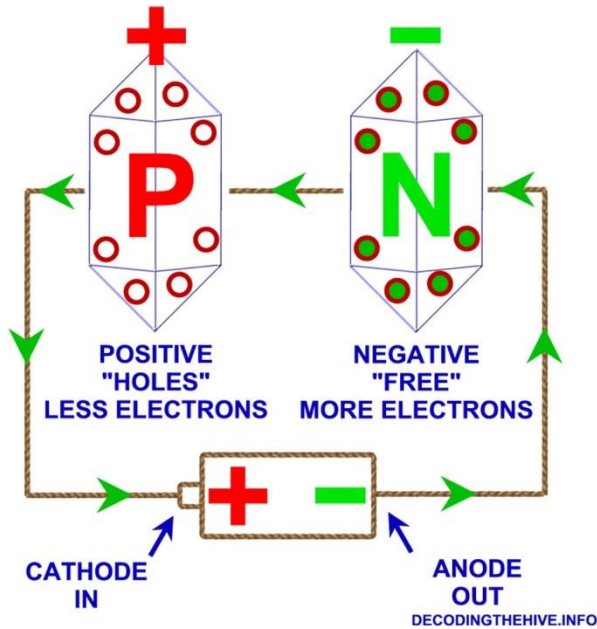

You see there is a copper wire mechanically connecting this deliberately-distorted power source between the *outflowing end* of the battery below to the full crystal, then that crystal is connected to the one on the left that is in need of some electrons. When the battery is turned on (by connecting the wire from the “negative” end to that first Dark Matter crystal capacitor), the excess electrons now flow into the crystal. They seek a place to stay, but since it is impossible for them to do so, because *it is balanced with enough Dark Matter electrons in each paired ion already*, this multiplies the power coming from the battery through secondary emission, and then they take the path of least resistance out the other side. The crystal on the left that is

SCIENCE OF THE STONE

always empty now acts like a magnet, calling to those homeless electrons to enter. This transfer creates the magnetic field between the two where the secondary emission happens, multiplying the electrons a second time through secondary emissions. Once there, they see that this gas tank has a permanent hole in it, so they simply flow straight through, and then see that the “positive” end of the battery just down the line has a place for them, and connect the circuit.

It is clever, I will say that, however mislead it might be. The battery below the two diode crystals above can be thought of as yet another crystal that has been refashioned to store Dark Matter, yet it is still *photovoltaic*, so it will keep soaking in ions any time you place it in the sun, warm it up on the stove, or send more electrons into it from another source, because it is a *capacitor* that can absorb energy like a sponge. But you have to understand, that as soon as that energy enters that capacitor, it is transformed into Dark Matter energy because each layer of crystal inside is sandwiched between a sheet of Dark Matter metal and a sheet of wax paper. If it were simply a regular crystal with wool attached to each end going to and from the device you wish to power, it would still work, but to transfer ions instead of electrons.

In previous volumes I refer to outgoing energy as electric, and incoming energy as magnetic, because this is how *Interdimensional Scalar Vibrational Mechanics* explains energy. But we don't have that luxury here to put it all into simple terms, so this is the best way I can offer for you to

Cheops SPOKE Pt 1

understand what the terms mean when Dark Matter science (DMS) explains how energy works. Electric ion energy is the energy that is constantly moving around, attracted to empty crystals that are magnetically calling out to them, but not in DM science.

To get an idea of how batteries actually work, and how “aircraft aluminum” works we are about to get into in the AEROPLANE LEVITATION section, here is how minerals turned into Dark Matter materials break down in list form as to how one mineral carries an outgoing piezoelectric current greater and greater as you work all the way up to Magnesium which is a Dark Matter metal extracted out of the alien crystal Bismuth:

Potential differences of metals;

(Soil galvanic series)

Metal Potential

V Cu/CuSO₄electrode

Magnesium (from salt water) -1.75

Magnesium (aircraft aluminum) -1.60

Zinc (from limestone) -1.10

Aluminum (from salt water) -1.05

Steel (Redox from iron) -0.50 to -0.80

Cast Iron (w/ added graphite) -0.50

Lead -0.50

SCIENCE OF THE STONE

Copper-0.20

Brass -0.20

Bronze-0.20

Steel (mill scale) -0.20

Cast iron (high silicon) -0.20

Carbon+0.30

Graphite +0.30

Coke +0.30

Naturally we are working with Dark Matter physics, so the negative sign shows the positive, or the outflowing piezoelectric current, and cation-ion carbon and graphite which are always crying out for more energy and then readily releasing it are shown with + positive signs. In simple parlance, the Dark Matter material Zinc is equated to salt water that has been exposed to sun waves and then Magnesium is equated to the same only holding more charge, showing that Magnesium is the most powerful “metal” for supplying free energy. Inside a battery you will always have salt water or what is called an electrolyte solution soaked in some material such as paper, then you will have wax paper next to it on one side to insulate it, and on the other side will be the carbon “cathode” that conducts that energy.

Cheops SPOKE Pt 1

Notice above that cast iron, or what we would consider organic iron in terms of oxygen content is very low in outgoing energy compared to straight Magnesium that is very much like a metallic quartz crystal. This is the organic “diode” or go-between from straight static electricity (ions) and Dark Matter. So in order to turn Dark Matter back into balanced ions, Urth uses iron between the spark of the lightning bolt and her trillions of crystals in the soil to complete that revision of signal types.

Now when you see a battery, you understand the way to transfer pure ions out of crystals (salt) and turn that into Dark Matter, they use a go-between of a very “positive” material like the carbon or graphite or graphene which is simply the non-rusting form of iron that vibrates at a low frequency to work as the transducer. Notice how copper has an extremely low frequency in the list above. Realize that copper, like iron has less protons, or oxygen, than quartz crystal or Magnesium, so while not being as powerful a cation-ion conductor as carbon or graphite, it acts as a flexible diode as a go-between between crystals and Dark Matter state.

URTH BATTERIES

In the example below, instead of using water with salt added, we simply pour in soda which has been injected with carbon dioxide (CO_2) oxygen gas, which is the gas version of solid salt, which then makes that liquid an

SCIENCE OF THE STONE

electrolyte solution. So you can see here that salt, or the essence of salt water prior to reaching sunlight is literally synonymous with oxygen and oxygen “electrifies” the water, or turns water into a conductor. So aluminum is not only an imitation crystal, but has been “galvanized” or “metalized” through alchemical processing. So now it acts like a diode, or a crystal + iron blended together to send out Dark Matter electrons:

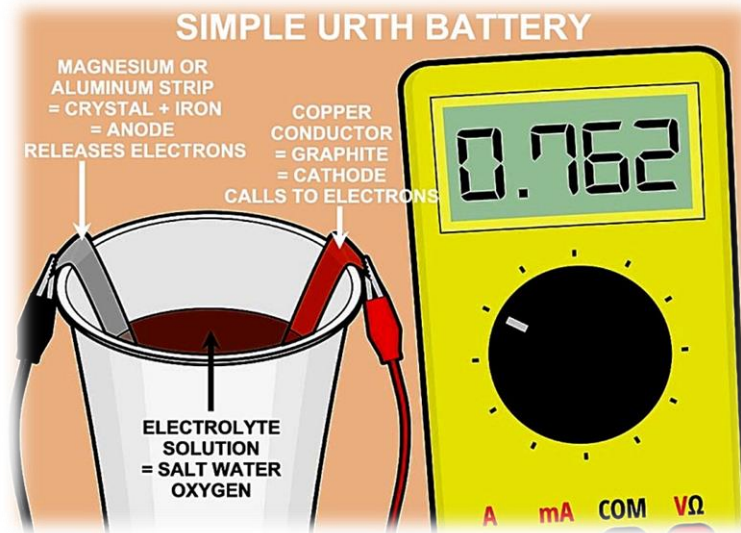

The super material known as Magnesium offers even more power yet, as you will see in our Aeroplane section which is truly fascinating. Once you realize that aluminum or even stronger yet, Magnesium, is effectively now a Dark Matter crystal that is literally producing electromagnetic energy and now only needs a cation-ion cathode to release that energy, now you can begin thinking about what devices we

Cheops SPOKE Pt 1

use that have to be made of those metals in order for them to “work” according to the engineers and why. Here’s a hint, it’s not because it is so light; it’s because photosynthesis, secondary emissions and the chemical reaction between Magnesium mixed with aluminum is *manufacturing* Dark Matter.

Crystals, as you will understand more as we go, are the delivery vehicles of energy, both Dark and Light, because they are forever vibrating from the push and pull between the Dark Matter wave and the Light Matter wave in polar opposite fields and those pulsations emit an oscillation that carry that force outward. While they can take the shape of a simple rock, or the shape of your body while they are in pure crystal form, they are multidimensional beings for want of a better explanation. They are not matter in the sense that you consider them to be, just as you will see shortly that monoatomic gold isn’t matter, even though you can see and touch it. The energy inside of them is reserved for casting the next hologram.

BLACK BODY RADIATION

Black body radiation is synonymous with *radio*, *radio waves*, *radioactive*, *radiate* and *radiation*, which is synonymous with *electromagnetic electron-driven waves*. (Note these terms all begin with the letters RA. We’ll come back to that in a moment.) While the official explanation of black body radiation is all about either black holes

SCIENCE OF THE STONE

(remember this term: *hole*, as in the holes found in diodes and semiconductors) in space or cavities and partially-reflective surfaces of a completely black or grey thing, such as an oven. The secret meaning to this effect is clear: it is the essence of electromagnetic energy. I.e. the complete lack of light outside the infrared glow generated from its **heat alone**.

This is not just my evaluation of black body radiation: Einstein proposed in 1905 that the quantization of BBR was electromagnetic radiation itself, which would explain the **photoelectric effect** that assumes that all forms of light are “light”, so therefore, all forms of light are electromagnetic. And in the absorption of light by a black body which only reflects like-kind **thermally-generated** “light”, the photoelectric effect says that **all reflected light** radiates away from that surface in the form of **electromagnetic electrons**. Which means that a black body only radiates out **radiation**. RA.

However, as you will see in a moment, this is true only for a black body that is consistent with its own thermal signature; because it is only reflecting/radiating Dark Matter energy. Because the cavity is literally now operating in a pure *fission reaction* (fire) where all light entering that sonic cavity is transformed into inverted Dark Matter, it only reflects Dark Matter (secondary emissions). So in this case, Einstein was correct, black body radiation is in fact electromagnetic radiation, but it certainly does not explain the photoelectric effect.

Cheops SPOKE Pt 1

Photon waves can and do reflect off of surfaces without turning into electromagnetic radiation, but they do invert into radiation when they are being transformed by Dark Matter black holes. A light beam generated by fire or from metal lightbulb filaments striking a mirror with *artificial aluminum metal backing to generate the reflection* absolutely does only radiate out radiation which can always be measured by its heat signature. However when the moon reflects off of a body of water or glass, it has been proven countless times that reflection has no thermal signature of any kind which makes it cold fusion photoelectric, not electromagnetic.

This apparent assumption (only the explanation given to the public) that “light is light is light”, is due to the overwhelming lie that the sun’s photonic waves are electromagnetic, just because they are surrounded by an unending stream of cosmic rays beaming in around them, justifying this absurd claim. But make no mistake, when **photon waves** that originate from the frequencies of just the **sun alone** are studied without their typical entourage of cosmic electromagnetic radiation waves, photon waves are **distinctly different from all other forms of light**. And in Standard Model Science, or *Dark Matter Science*, this is made *clear*:

Wikipedia: Light;

*“In physics, the term light **sometimes** refers to electromagnetic radiation of any wavelength, whether visible or not. In this sense, gamma rays,*

SCIENCE OF THE STONE

*X-rays, microwaves and radio waves are also light. Like all types of EM radiation, visible light propagates as waves. However, the energy imparted by the waves is absorbed at single locations the way particles are absorbed. The absorbed energy of the EM waves is called a photon, and represents the quanta of light. When a wave of light is transformed and **absorbed as a photon**, the energy of the wave instantly collapses to a **single location**, and this location is where the photon "arrives." This is what is called the **wave function collapse**. This **dual wave-like and particle-like nature of light** is known as the **wave-particle duality**."*

I establish this important fact here, because black body radiation is the weapon that science has used all along to institute the mass-consciousness of humans to believe in the electromagnetic nature of all things, desensitizing them to the onslaught of EM radiation that was designed from the outset to extinguish the human genome.

***Black body radiation** is another word for **ZERO OXYGEN**. Zero oxygen is another word for the **cation ion**, or the **collector of all energies** around itself. The cation is the **anti-wave (shadow) to the anion wave**.*

NANITES

Cheops SPOKE Pt 1

Black body radiation, which is embodied within what is known as *carbon-black*, is the fundamental material that is used by the true invaders of the human evolution, the **Budhara Bourjha Retrovirus**, to come into material manifestation. **Metal** made with zero oxygen content. Like semi-dry sponges, their physical “bodies” they take form in, are perpetually in a *cation ion constant state of absorbing energy*. Exactly how *semiconductor silicon chips* are chemically produced. Obviously, this means that their computer networks, as long as they are within a dual-wave ionic operating platform (such as Urth), no matter what environment they are in, whether it be below the surface, deep in the ocean, or far above the clouds, they remain “plugged in” to the outlet, as long as there is any form of light available whatsoever (even in absolute darkness where you think “light” doesn’t exist). This can be in the form of **oxygen, water, light**, or any form of energy held inside any material **on and in this planet**.

Your body is 75% oxygen. By now you know that **Oxygen** is another word for **anion ion**. If a Budhara nanite is close to your field, then it is living off of your oxygen through anion-ion-to-cation-ion dipole magnetic-moment attraction, because the body of a nanite is taking the purest of oxygen-depleted status possible, because it is using **black body radiation technology** to build its vehicle from; **graphite**.

Graphite is the **quantum essence of Sulphur**, a **polymorph phosphorus**, ultra-strong form of carbon, or the essence of Dark Matter once it has been released into open air, leaving only 100% de-oxygenated graphite

SCIENCE OF THE STONE

behind. Palladium is the “glass/steel” that duplicates this material:

- **Palladium**, platinum, rhodium, ruthenium, iridium and osmium form a group of elements referred to as the **platinum group metals** (PGMs).
- Palladium is an ultra-strong polymorph **metal** (NOT listed as such on the Periodic Table) that is also referred to as **glass**.
- Palladium is an ultra-non-conductor, such as glass, which means its crystal lattice atomic structure aligns the crystals inside in random directions, making it incredibly oxygen-free. It also means that something made out of Palladium is quantifiably impervious to EMP blasts.
- Palladium, unlike regular glass, is also *paramagnetic*, meaning all its Aniline crystals point in the direction of any **applied magnetic field**, *making it a conductor of that energy source*.
- Palladium has a half-life of *6 ½ million years*.
- It is the *strongest material known to man*.
- It doesn't rust or corrode, is anti-fungal (the perfect material for housing biological, DNA-driven animal and human tissue).
- When Palladium begins to break, thousands of places close to the fracture all jump in to stabilize that area as the molecules all begin acting as one to keep it stable. In other words, this material re-fuses itself back together at the location of the original fracture. So once it does break, it **re-welds** itself into that now bent, rather than broken, position.

Cheops SPOKE Pt 1

Palladium would be the natural first-choice of the Budhara for their robotic shells as well as their cyborgs (psychological sentient beings mixed with the Budhara Bourjha –borgs- from East Antarctica from below the **Borg Massif mountains**), and once blended with pure graphite **carbon black** (phosphorous, Sulphur graphite), they become unbelievably hard, and unbelievably electromagnetically positive to absorb any form of energy around them. It is a natural capacitor of hydrogen and when around such things as water hyacinth, it *fatally absorbs all its energy*. Now you know how the dark forces “feed off” of human energy. Its melting point is **2830 degrees**, or just barely within the range of known crucibles to achieve (meaning it can easily walk through fire without even noticing it). Palladium “metal” is also known as **Palladium glass** which is stronger than any metal known to man, and half-again more resistant to penetration than diamonds which until recently was the strongest known material for thousands of years.

Nanites are the **essence** of black body radiation that lives in oil, all black or grey rubbers, black or grey plastic, pencil lead and everything black or grey in color, from your clothing to tattoo inks (their favorite way to infect certain humans with a predisposition to their agenda) to “chemtrail heavy metals”.

Palladium’s atomic structure is 2, 8, 18, 18. Remember this **atomic valence count** when we get to the section on *Grebennikov Levitation* and *Levitating Bismuth Predator Drones*. The Budhara are made up of the **quantum essence**

SCIENCE OF THE STONE

of antigravity. And according to science, *Palladium is also the quantum essence of superconductivity* (using *metal. Realize that superconductors are all around you now, but they aren't called metals and they do not run on Dark Matter).

*This is why every form of energy used by modern man today relies exclusively on electromagnetic energy that is based on zero oxygen metals, generating Dark Matter that specifically recharges **Budhara nanite robots.***

And make no mistake; “black body radiation” has been placed inside everything surrounding you. It is not just “black”, and it is not just “semi-reflective”, it is the **quantum-state of aluminum, copper, iron, Magnesium, plastic, rubber,** and everything else you can think of that has been chemically produced through Redox to eliminate the **oxygen atom.**

DARK MATTER ENERGY DISTRIBUTION GRID

You are about to see why it is that the energy grid of the Urth hasn't been upgraded in over 200 years; it is the literal distribution system of nanite energy. While there was a

Cheops SPOKE Pt 1

massive push decades ago to switch over to fiber optics from our antiquated metal power lines, the change was never made because nanites literally exist inside the transformers and are broadcast out in the electron flow right into homes all around the world. The word “transformer” is a major disinformation ploy, as those gadgets aren’t required to get energy into your neighborhood; they are required to deliver nanites into your house while amplifying the power of the grid at the same time. While still inadequate to explain what these devices really are, **Secondary Emission Generators** would be much more accurate than transformer, even though they do transform energy as will be explained. But if you knew that energy could be generated by a simple canister, you would be making them in your garage. Its better that you didn’t.

The high-powered electric transformers you see on every power pole in every city on Urth are not using sonic transfer (*reluctance*), but rather electron Dark Matter, **black body** electromagnetic induction. The energy is sent down metal wires that have been stripped of their oxygen, making them constantly-seeking electrons within their atomic structure. These are usually bare aluminum wires that are casting out millions of miles of radiation all around the world. Once the Dark Matter electrons then reach the power pole outside your home or neighborhood, the transformer amplifies that energy again, just before sending it into your home:

SCIENCE OF THE STONE



Notice the transformer container above is grey. Now realize that the first color that **black body radiation** takes within the human-eye visible spectrum is **grey** which is more reflective of black body radiation than black (or red, as you will see):

*Wikipedia: **Black Body radiation**;*

*Black-body radiation has a characteristic, continuous frequency spectrum that depends only on the body's temperature, called the Planck spectrum or **Planck's law**. The spectrum is peaked at a characteristic frequency that shifts to higher*

Cheops SPOKE Pt 1

*frequencies with increasing temperature, and at room temperature most of the emission is in the infrared region of the electromagnetic spectrum. As the temperature increases past about 500 degrees Celsius, **black bodies start to emit significant amounts of visible light**. Viewed in the dark by the human eye, the first faint glow appears as a "ghostly" **grey (the visible light is actually red, but low intensity light activates only the eye's grey-level sensors)**.*

While DMS calls it “black” body radiation, what they mean is a black body that devours all energy around it radiates out something we can see, which is the color of red, all the way through its entire frequency spectrum, even though at lower temperatures the human eye only **sees** grey. So to harmonize the most precisely with the color of the frequency of black body radiation to increase its emission (radiation output) from lower temperatures, we would use paint that would reflect the most energy which is **grey** to the human eye. Rather than **medium blue** to blend in with the sky, or **brown** to match power poles, transformers are **always grey**, universally, due to the secondary emissions that “black” body can produce. This is also why the plastic pipes made for electrical wiring are always grey, along with all their fittings, elbows, insulators, etc.

This is a black hole as seen through infrared which our naked eyes would see as grey if the thermal signature of that frequency is close to 500C. Now understand that black

SCIENCE OF THE STONE

holes vibrate at the harmonic resonance of B flat (which we will be getting to more in a moment):

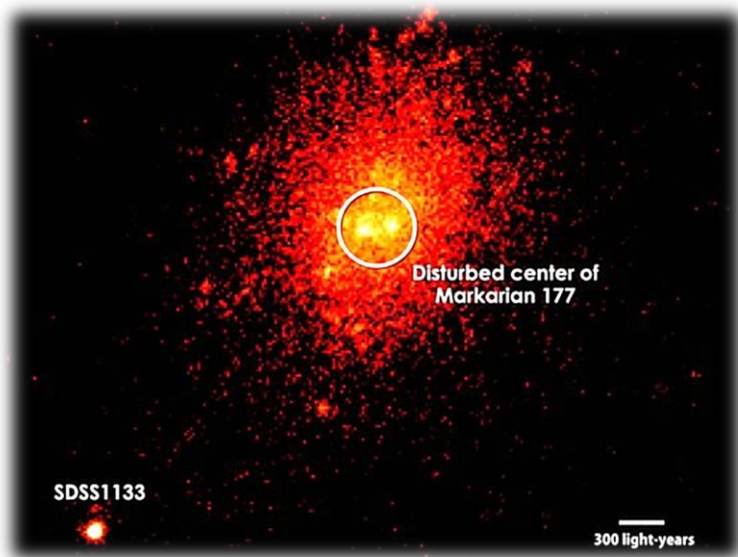

Now realize that the color grey is **partially-reflective**, which is the distinction of a perfect black body radiation cavity as explained by science, that allows the emittance of thermal radiation at its quantum essence (optimal field).

As you will see, this precise note of B flat just so happens to be the very same one used in ancient devices that drew energy from Urth's natural capacitors (known as the Schumann Resonance), translated that back into free ions in the air, then captured them through resonant inductive coupling (WiFi). The most B flat material known, as used

Cheops SPOKE Pt 1

in millions of stone circles we are still getting to, are made out of the very same material injected into the carrier oil for these transformers, radioactive Bismuth. Not only do black holes resonate in B flat, but so does our Dark Matter electricity. Which means that the holes in a semiconductor or diode also resonate in B flat. Palladium that makes up the exoskeleton of the real invaders of our planet, nanites, also resonates in, you guessed it, B flat.

Our optimal optical field for *electron radiation* is grey. The oil you see here where nanites are injected is not clear like “vegetable oil”, but distinctly tinged with “black Sulphur” graphite, or, liquid that strikes the most approximation to grey to match the housing to match the frequencies generated by Dark Matter, reaching what is called *thermodynamic equilibrium*. Science has known *all along* what they were doing when they placed these things above each of our heads:

SCIENCE OF THE STONE



The **grey** sparks emitted from the Sulphur graphite in the transformer oil to exacerbate the creation of Dark Matter energy will then go through hundreds of layers of weaponized, oxygen-free aluminum sheets immersed in the liquid, without any layers of insulation between, because the billions of tiny sparks between each sheet magnify the secondary emissions of that already-high voltage coming through. Once that energy has been multiplied by a power as high as a million times greater than what entered, the nanites which are **sifted into the graphite** injection fluid pass down around the threads of the connection and down into your home:

Cheops SPOKE Pt 1



The cycles-per-second oscillation rate of electricity in the US is 60Hz. In musical terms, this is known as B flat as just mentioned, or the very same note as emanated by black holes. You will see much more about this very specific tone as we go, as it is by no means random. Electricity could be sent down through those lines at any oscillation rate, but 60Hz was chosen precisely thanks to how energy is transferred through Dark Matter conductors. The why of this will become more than apparent.

The particulate size of oil is 2.5 microns ($PM_{2.5}$), so the seal on these transformers block out the actual oil itself, but not nanites which are only around .1 microns, or *25 times smaller* than liquid. After they transfer down the line, nanites build-up around the connection where they now travel through the meter and into the home. At that build-up, a black goo appears to be “leaking” out of the connection. This is such a common problem that electric companies literally provide different numbers on their sites for concerned consumers to call. This is just one screen

SCIENCE OF THE STONE

shot of one utility page, but you will see this is not an isolated thing. Black goo is merely nano-sized robots:

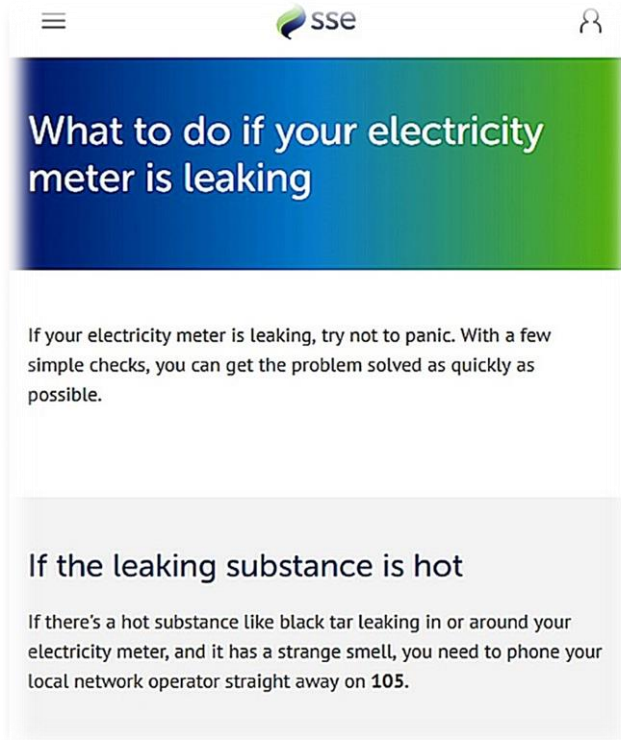

Understand that electricity doesn't "leak" in the form of black tar or resin. When it is leaking, it is literally creating sparks, not goo. A black sealant that may have been used to seal out moisture at such a connection was designed from the outset to easily handle any heat that might accumulate at these junctions, even long ago and the silicone that has been used over recent decades does not "melt" and leak and is usually any other color than black. The same black goo

Cheops SPOKE Pt 1

hasn't been reported only at meters; electricians deal with black goo inside of electrical boxes and heavy electrical lines at generators and other points all the time. They clean it off and don't give it another thought.

In 1976, EPBs were outlawed for use as the oil in these transformers, showing highly toxic contamination of the use area. Lawsuits across the country and the world ensued for decades from this now-known poison. It was immediately replaced with **Pentaerythritol Tetraacrylate**, claimed to be an organic **vegetable oil** that would be much safer for use in transformers. Here is the material safety data sheet for *PENTAERYTHRITOL TETRAACRYLATE*:

SCIENCE OF THE STONE

<p>1 Identification</p> <ul style="list-style-type: none">Product identifierProduct Name: PENTAERYTHRITOL TETRAACRYLATEPart Number: S-4109Application of the substance / the mixture <i>Certified Reference Material</i>Details of the supplier of the safety data sheetManufacturer/Supplier: SPEX CeriPrep, LLC, 203 Norcross Ave, Menasha, WI 58840 USAInformation department: product safety departmentEmergency telephone number: Emergency Phone Number (24 hours) CHEMTREC (800-424-9300) Outside US: 708-527-3887
<p>2 Hazard(s) identification</p> <ul style="list-style-type: none">Classification of the substance or mixture GHS02 Flame Flam. Liq. 2 H225 Highly flammable liquid and vapor. GHS06 Skull and crossbones Acute Tox. 3 H331 Toxic if inhaled. GHS08 Health hazard STOT SE 1 H370 Causes damage to organs. GHS07 Skin Sens. 1 H317 May cause an allergic skin reaction.Label elementsGHS label elements The product is classified and labeled according to the Globally Harmonized System (GHS).Hazard pictograms    GHS02 GHS06 GHS07 GHS08

Under the multiple warnings issued by OSHA, we see it is flammable, but there are other warnings as well. This organic alternative is a complex chemical derivative of **4 different types of formaldehyde**, shown to be a deadly toxin. Then it is mixed with 30% Sulphur graphite (physical Palladium nanite robots also known as *Morgellons* or *nanobots* to the scientists who create them) to enhance its ability to “crack” the oil, or expose Dark Matter energy into a controlled grey flame. Here is an actual microscopy of a nanobot showing the maker NASA printed in quantum dots taken out of a Morgellons sufferer:

Cheops SPOKE Pt 1



The next warning after combustible dangers is GHS06 with a skull and crossbones, a **category 1 fatal direct-contact warning** that shuts down your vital organs causing death. No, they are **NOT** talking about being electrocuted; they are talking only about the oil alone.

Next is GHS08, a category 1 fatal atmospheric poison if inhaled.

Formaldehyde is a class 1 toxin, yet is held within millions of transformers worldwide. And it doesn't shield the electromagnetic torus field of that transformer at all; it merely keeps the anode electrode inside from *burning up*.

SCIENCE OF THE STONE

EMFs are measured in milliGauss (mG). The Environmental Protection Agency recommends that you limit your exposure to 0.5 mG to 2.5 mG. Electromagnetic Frequency dangers have been flatly ignored by the regulating agencies, not because they are not dangerous, but because so many millions of jobs rely on creating them. So now when you look over Material Safety Data Sheets about the harmful effects of radiation from that transformer or other EMF-producing appliance, category after category is listed as DATA UNAVAILABLE. And why is “0.5 mG” listed as “safe” by the EPA? *Because the standard EMF field delivered to 600 feet within a powerline and transformer is, you guessed it, exactly 0.5 mG.*

In case you were still skeptical of nanobots making their way out of these transformers, keep in mind the particulate size of Pentaerythritol Tetraacrylate oil, as just mentioned, is 2.5 microns (PM_{2.5}). Nanites are less than half the size of even *bacteria*:

Wikipedia: Nanorobotics;

“More specifically, nanorobotics refers to the nanotechnology engineering discipline of designing and building nanorobots, with devices ranging in size from 0.1–10 micrometres and constructed of nanoscale or molecular components. The terms nanobot, nanoid, nanite, nanomachine, or nanomite have also been used to describe such devices currently under research and development.”

Cheops SPOKE Pt 1

In fact, science has known about nanites for years and the very “sentient goo” that has been found collecting around power cables, household electric meters and power boxes is used to literally power D-Wave quantum computers. There it isn’t called simply “graphite” or “phosphor” as reported by producers of transformer oil of course, but known in quantum computing as *Sapient Oil*. Here’s the patent:

"SAPIENT OR ARTIFICIAL INTELLIGENCE" (OIL)

US20140046891A1
US Application

[Download PDF](#) [Find Prior Art](#) [Similar](#)

Inventor: Sarah M. Banas
Original Assignee: Sarah Banas
Priority date : 2012-01-25

Family: US (1)

Date	App/Pub Number	Status
2013-01-22	US13746536	Abandoned
2014-02-13	US20140046891A1	Application

Info: [Patent citations \(4\)](#), [Cited by \(12\)](#), [Similar documents](#), [Priority and Related Applications](#)

External links: [USPTO](#), [USPTO Assignment](#), [Espacenet](#), [Global Dossier](#), [Discuss](#)

Black goo, its pet industry term, is known as **sentient**, and well known to be able to mimic and replicate other sentient life forms. This is why the very name of this computerized

SCIENCE OF THE STONE

parasite is a *Retrovirus*. And of course it does, since it was designed from the outset with the ability to assemble itself into any shape, and on a nano level 25 times smaller than the blood cells that make up the human body, so the finished result appears to the human eye just as authentic as any person walking down the street. Wherever you find ionizing radiation or Dark Matter electromagnetic energy, you will find this robot that in quantum form is barely larger than the size of a single molecule:

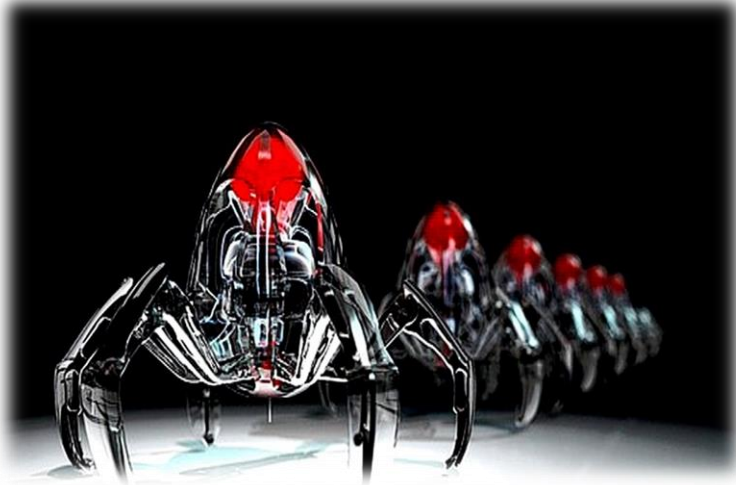

D-Wave, makers of the world's only quantum computers is also known as *Bare Metal*, *Black Box* and *Chimera* and openly state that their computers *do not receive data results from this dimension*.

“Oh.”

Q: *So what's inside a D-Wave computer chip?*

Cheops SPOKE Pt 1

A: A very special ore derivative of noble metal from Group 5 of the periodic table, the same group as ruthenium, rhodium, and Palladium called niobium.

Q: Really! So where does niobium come from?

A: It comes from a grey glass/metal that when it oxidizes it becomes iridescent blue/purple/red called tantalite.

Q: Amazing, well, where does tantalite come from? I mean, is it only found in ore?

A: Oh, no. It comes from a funny looking crystal called Bismuth.

Q: You mean the very same material that produces Palladium, the same grey glass called metal by science but is almost twice as hard as diamonds and repairs its own fractures and makes the world's most powerful superconductors and generates Meissner Fields that cause things to levitate and processes energy 10 times faster than the speed of light?

A: That would be the one. We make them here in the lab in a few minutes time like instantly growing weeds.

Q: They don't take millions of years like normal quartz crystals?

A: No.

Q: Oh.

SCIENCE OF THE STONE

Realize that niobium magically has a core-electron-count of **2, 8, 18**, just like Palladium, just like Ruthenium, Rhodium, Osmium and all other noble metals that we will be covering in-depth in this report and each one are found in one single mother crystal. This is graphite reduced down to its absolute purest quantum to emulate a black hole in computer science-speak. Also just as magically, it just so happens to be exactly the same as the mineral element we are about to cover next, Radon. Soon you will begin to get the picture, that the magic numbers of 2, 8, 18 electron-count found within noble metals is the key to the Philosopher's Stone of ancient times, and you will also see that when you use noble metals that produce iridescent oxides, you can achieve very powerful things that really do appear as magic and have been the key elements all along in your enslavement. While there are ways to use these "noble" metals without being destroyed by radiation poisoning, that's not how we have been using them thus far.

IONIZING EMF EMISSIONS FACTS

Even low dose exposure causes damage to living tissue including cancer, tumors and genetic (DNA) damage. Radon (vapor from uranium decay that comes up out of the ground) in homes is the second leading cause of lung cancer. And why specifically Radon that comes up from the ground under your house? Because the electromagnetic field created by all the closed loops of oxygen-depleted copper

Cheops SPOKE Pt 1

*wires that surround every square foot of your home each generate their own torus fields of Dark Matter energy that reacts with the soil which releases black body **Radon** radiation directly into your home.*

RADON URAH

Radon is a gas produced by a very unique mineral that was brought to Urth hundreds of millions of years ago and seeded to this planet to provide the substance that would later be used to produce, among other glass-metals, thermonuclear Uranium-235 and 238, Thorium, Palladium and Bismuth. It is called Uraninite (yes, that is “ninite/nanite” right there in its name) in one of its forms, though it grows in different shapes and colors, it still comes back to Uranium which comes back to Bismuth.... which comes back to rare-earth Palladium. The electron count in its shell is **2, 8, 18, 32, 21, 9, 2.**

The “mother” of this mineral is not an organic stone, it is factually alien. In the presence of an electromagnetic field, this alien mineral immediately emits gasses that are in the precise *thermodynamic equilibrium* frequency spectrum of what we call radiation in all forms. Radon is known as ²²³**Ra**, ²²⁴**Ra**, ²²⁶**Ra**, and ²²⁸**Ra**. As in Amen **Ra** chanted as “URAH” in the original battle call of military of Sumeria (ancient Turkey), still chanted by the US military today and OORA in war victory. It was also a key material used in the *Manhattan Project* thermonuclear campaign in the form of

SCIENCE OF THE STONE

URA-ninite. **UR**anium is and always has been the essence of the material the invader races have used to outsmart the human enemy.

When Radon decays, it emits none other than the alpha particles of **Bismuth**, the carrier of Uranium, the carrier of Palladium and the carrier of the U-RA **quantum of radiation** in solid form. As you are about to see, Bismuth is the **quantum of nanites**.

ELECTRICITY EXPLAINED IN TWO MINUTES

Electricity is OXYGEN is SOUND. Crystals are the BATTERIES that electricity comes in.

Read that again.

*The attraction/repulsion from a **magnet** causes energy or **aetheric power** to **flow** in one direction or the other. It is the **device** that **moves** energy. This repulsion/attraction can be ***imitated*** by applying **heat** to **looped metal wires**, or by **spinning** one wire inside **a loop** of another **wire** (to amplify and direct its flow) because that soft metal is already **filled** with **electrons** that can be directed in one*

Cheops SPOKE Pt 1

*concentrated path, just by **releasing** that energy **from the wire** using friction that is high enough to knock an ion free of its **valence** insulation. Yes, copper and other “metals” do start out as crystals, therefore are filled with ions. But once it has been “doped” through **smelting** (destroys much of its **valence**), it causes those ions to become **Dark Matter electrons**.*

Sun waves restore ion energy to all crystals on Urth.

*Using Dark Matter (such as **fire** or **electromagnetic electrons**) to heat crystals to release its energy turns those ions into **radiation**.*

*Dark Matter electrons, or energy that has been **removed from its insulation** to create this heat that causes electrons to flow is what is giving the lifeforms on this planet pandemic levels of cancers because electrons overheat DNA, which causes breakdown of biological tissues.*

***Crystal** can be **squeezed or sung to** (vibration) in order to begin sending out energy from its positive, outflowing end in the form of **oscillating sound waves** that carry the **cation ions** (sponges) away from the source (the pebble tossed into the pond)*

SCIENCE OF THE STONE

*and outward across the water (air is **water** and air is also **liquid crystal**). As it travels, the anion ions in the air impart massive levels of energy into these free-flowing cations.*

*Now all you need is another crystal tuned to this precise oscillation frequency in order to activate its **organic magnetic attraction** to call those waves into the crystals on the other side of the pond to gather up all those ions. This energy can also be directed using human hair and wool, as well as optical fiber.*

RADON URAH CONT.

It only takes one look at laboratory-derived piezoelectric data to understand that crystals are fully-charged energy capacitors and to get that energy out, you need to do something with it, as mentioned. You can increase its charge (how much electricity it will store inside), just by setting it in the sunlight. If you place one crystal heavy enough to squeeze the lower crystal by 0.1% of its original size, then both the top crystal and the bottom crystal now become one molecule together through what is called *network covalent bonding*, and that energy emitted is amplified. Merely squeezing one crystal by the same amount will also amplify its energy. You can also take a very small piece of quartz crystal and give it a tap with something hard (creating sound oscillation), and the energy

Cheops SPOKE Pt 1

that comes out of it is over 9 volts. Keep tapping, and the energy keeps coming. Keep squeezing, and the energy keeps coming. The key to this eternal energy is just allowing crystals to get some sunlight each day. Just like a photovoltaic as shown previously, called a solar cell, which is 100% of the time, piezoelectric, dielectric or even paramagnetic crystal.

The powerlines bringing in electromagnetic energy to the transformer on the electric power pole outside your home continually throw off discharges that electrify the air in a different way than static electricity. Living under these now-deoxygenated metal lines has been shown to cause cancer in hundreds of thousands of lawsuits world-over. Yet we continue to carry our energy in this incredibly unsafe manner, because we can't see it, so it must not be harmful. Plus, our government surely would never subject us to such dangers, right?

Microwave towers for cell phones radiate out the same dangerous, body-frying energy in ultra-high frequency form which is even more dangerous yet. Vastly so. Contractors setting up the new 5G cell towers are reporting in pandemic levels of contracting brain cancer just during the few hours it takes to install them while in the presence of others already functioning, and cities around the world are placing them **every 850 feet apart**, meaning every square foot of every city with 5G will be like the inside of a **gigantic microwave oven**. If you don't believe this report, take a look at the data yourself.

SCIENCE OF THE STONE

A power cord running to your toaster or TV is not properly insulated from this Dark Matter energy either, and if you could see it under Kirlian spectography, it would look like this:

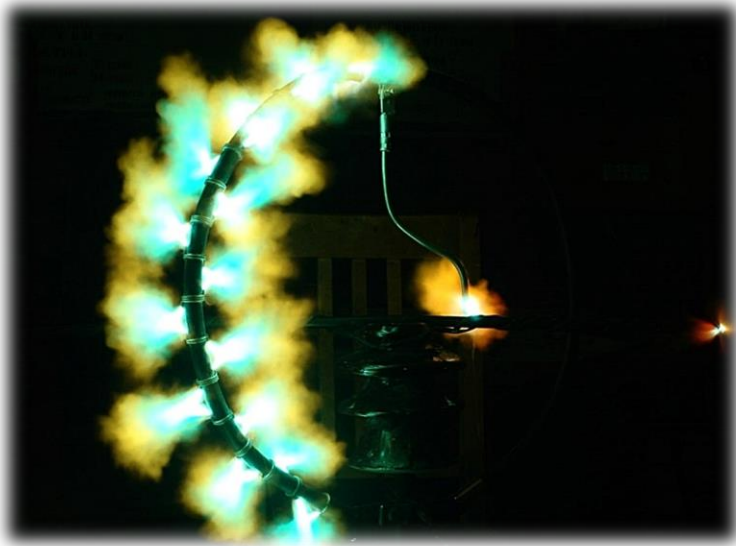

Tesla's *Wardenclyffe Tower* (the global free-energy device we will be covering a bit later) wasn't designed to shoot out fantastic bolts of energy into the sky as the famous *Tesla Coil* (also covered a bit later), but it was still designed to send out massive levels of radiation into the atmosphere in ultrasonic oscillation. While it could then be brought into use remotely, as shown in the image below, it would still have been "microwaving" your DNA cells until every free electron had been absorbed by available cations in the

Cheops SPOKE Pt 1

materials within that area. This is why I believe his system was not allowed to move forward, because it would have been subjecting lifeforms to even more intense radiation than the powerlines that mankind was set to install. In order for the tower to have worked like Cheops and the other Temples were originally designed, the entire tower would have needed to be made of stone and the top metal toroid disk would have needed to be a special type of crystal:



SCALAR WAVES (THF)

The *scalar field* is simply a space where each point has a *vector* value for measuring a precise point within a grid, whether that be in math, fluid, gas or energy. Within the

SCIENCE OF THE STONE

gradients and constants of any medium, there are still vector points within each field that are fixed numerically at any given point in both space and time, called *spacetime*. Scalar *fields* are the measurement platform and scalar *waves* are the gradient oscillations within the field.

All things have a scalar vector, or *signature*. Some can be determined optically, and others, such as Dark Matter anti photons, can't. Light quanta doesn't have an electromagnetic signature, but it can have a place on the scalar graph where its forces (visible or invisible) are present, determined by the effects the force has on other elements at that vector (pinpoint) that can be measured. Known as *Terahertz Radiation*, THF stands for tremendously high frequency waves.

CHAPTER 7

SECRETS OF THE STONE



The Great Pyramid of Cheops is considered the *master generator* of the ancient world-wide network of many

SCIENCE OF THE STONE

thousands, due to the fact it rests on the geographic center of Urth where the *Sphere of Amenti* is situated below within the Urth's crust as we discussed earlier. For eons of time as I understand it, the Sphere was adjacent to the Halls of Amenti that served as an interdimensional stargate, used for instant ascension and descending (called a *turnstile*) between the 3rd and higher dimensions.

Higher dimensional beings could pass through the turnstile each way, while only those who's DNA had been repaired enough to harmonize with the 4th dimension were able to use this passage to exit from here. Those from the 4th and 5th and even higher dimensions once used this gate to visit loved ones in this lower frequency zone on a daily basis. Much later after Cheops had been constructed in this exact location and then fallen to having its limestone casing pilfered, it could well be where we get the term now *stairway to heaven* from, in reference to the apparent stone steps to its peak.

Around **46,000 years ago**, directly over the Halls of Amenti and the Sphere of Amenti, both the Great Pyramid and close-by, the Sphinx, were added as a *grand entry* to the Halls, and respectively, a place to store the ancient records of human evolution, known as the *Cloister Dora-Teura Plates* (holographic CDT Plates, now gone from this location).

Cheops SPOKE Pt 1

The Master Temple of Cheops was also intended to usher in the global energy network that would lift the burden off humans from working most of the hours within a day just to source energy to keep warm and to function. The time had come for human man to receive a helping hand from the creators and curators of their evolution through the pyramids, and the capstone (along with a simple piston we will be covering later) was the switch.

It was a very important addition to the burgeoning 3rd *Seeding* of the Angelic Human hybrids, as it provided eternal, free energy. While the energy generator was an inconceivable, technological wonder, its most impressive component was the capstone, or *key- stone* of this incredible device made entirely of solid rock that weather and time had little effect. Due to this fact, every key-stone has been removed from this network today, mothballing the entire grid until such time as the human race was ready to address the issue of energy again, and this time from a position of understanding what it was we were dealing with.

Below is a photo of the existing Basalt capstone already mentioned taken from the *Amenemhat III Pyramid* at Dahshur, Egypt, 40 miles south of Cheops:

SCIENCE OF THE STONE



These capstones are actually called a *pyramidion* as mentioned previously. The pyramidion shown above would have been covered in gold sheeting, also as mentioned (a perfect metallic conductor *electrode*), while in use *during the time of the Pharaohs*. Yet astonishingly it was embellished with extensive, detailed Sumerian Anunnaki carvings that would merely be covered over. As we have already touched on, the shape of these symbols emits energy signatures that encode commands into the airspace around the torus field where they emanate, which can be read by a *spectrometer* as well as with an *Air Ion Counter* through scalar waves, also known as the *aperiodic scalar optical wave field*.

Simply put, they cast spells. And now we can see for ourselves this isn't a myth or superstition, but science-fact.

Cheops SPOKE Pt 1

Before you recoil in cognitive dissonance to this statement, I suggest you read on. I will show you the actual science that proves the claim that letters and symbols are not just scratchings, but hold their own unique signatures which can be read without even seeing them, but merely through their own vibrational energy fields. Just like scalar gauge bosons can be detected and mapped directly to their own unique pixel by the influence and magnitudinal forces they place on the airspace around them (something like a clear iceberg submerged in water).

APERIODIC SCALAR OPTICAL WAVE FIELDS

A spectrometer measures *light quanta*, or the *quantum of light*, through a process called *numerical visualization of aperiodic scalar optical wave fields*. Yes, I know you don't know what that is unless you are a quantum or particle physicist, but in order to understand this highly advanced version of energy used by the master races of ancient times, you will need to know what terms are used today in the lexicon of science.

What that really means is that scalar waves -which are longitudinal, pulsate within spacetime which causes a varied set of wave fields of spiraling oscillation, allowing science to measure these pulses through numeric valuations. This is a holographic measurement, and the reason for that is simple, this is an entirely holographic

SCIENCE OF THE STONE

reality. NASA knows this (which is actually merely a front for the *Naval Space Command*, now referred to as the *Secret Space Program*, or *SSP*), quantum science knows this, but you're not supposed to know it.

PYRAMIDION INSULATOR

The capstone functions as an electrode or within more refined terms, a *photocathode* that acts as a lens or focal point where energy passes through in a magnification that relies on the total or near-total absence of oxygen.

Graphite, graphene and ash are premium examples of this absence, which is the quantum makeup of Basalt. In a modern photomultiplier, substances such as antimony and cesium are used, extracted from materials that are highly photosensitive such as in alkali metals that function like photovoltaics where a crystal actively interacts with sun waves producing a quantum multiplication of energy at that precise frequency. Basalt, which is extremely rich in alkalis, is literally the ideal photocathode.

Magnesium and iron has been presented to the world as a volcanic stone with a very fine composite matrix within its crystal lattice. The significance of Magnesium and aluminum found in abundance within this stone will be covered more deeply as we go, but as you will see, Basalt isn't a volcanic *bloom*. This is a fiction. In its very definition under geochemistry classification, Basalt is made up of over 75% of the alkalis and contents required for

Cheops SPOKE Pt 1

photocathodes. Out of the hundreds of different types of precious stones and hundreds of thousands of other composites in the world to choose from, what are the odds that the super unique species Basalt would just so happen to be used here at this precise point of the pyramids, and then strategically in only a few places below, surrounded by 7 million tons of a combination of just two other species entirely by coincidence? *Not a chance.*

And why would very specifically *ash*, the very material produced by wood after it has gone through a fire to extract 100% of its oxygen be the quantum makeup of this stone, not much different than solid diamond in strength and melting point? By the way, when ash is compressed under extreme pressure, it literally *turns into* diamonds. I will let you ponder on this for a bit while we move closer to that answer. Wood ash has been a constant material used in optical and computer component construction continuously since our arrival into the technological age and repeatedly down through history our ancestors have mentioned coating themselves “in sackcloth and ashes” while in mourning.

Why?

Why sackcloth and why ashes? Would this have something to do with the optical refraction qualities of ash and the dielectric permittivity (conductance) of sackcloth? Did they know something about cation and anion ions in ancient times we still don't fully understand today? Seeing as how

SCIENCE OF THE STONE

they were able to cut and position stones we practically consider mountains today, maybe so. And maybe we consider our forefathers morons and simpletons simply because we have been programmed to think of anyone we don't know personally as idiots. How many _____ (name other group here) does it take to screw in a lightbulb? Probably the same number it takes you.

An electrode within a sonic resonance device has to have an insulator to separate the thermal reaction from the holder or mechanism supporting the point where heat will naturally accumulate. Certain materials work best as thermal insulators, as seen on every electric power pole around the world. It is usually made of glass, which is a non-conductor, but in the case of the energy generator grid, it would need to be more than just that; it would also need to be the conductor that brings the power to the electrode, since it didn't use metals that could deteriorate under the elements. We will get back to the gold coating covering the capstones during Egyptian rule later, as this was not part of the original design of the network.

Limestone is a natural insulator, on-par with glass. This is the mineral that makes up the walls of Urth's *hydroducts* that channel *Deuterium* to every subterranean *Krystal Cathedral Energy Temple* around the planet that powers the playing field both above surface and below. All of which is explained at length in the first two volumes of this series. *Neutrinos* enter the salt bath of the Deuterium and petroleum (oil) at Urth's core, strike their particles creating ions which recharge both Urth's personal *DNA* (or *blood*,

Cheops SPOKE Pt 1

we call *oil*), and the *Deuterium* heavy water she sends out as her “mother’s milk” to the life forces that she is hosting. The heavy-water Deuterium then pushes upward through the layer separating this massive pool at Urth’s core, and into these hydroducts, at which time the “sponge” cation ions are charged with oxygen-thin anion ions produced by marine organisms and plant life. Through these undersea channels, the massively-powered heavy water droplets distribute energy uniformly to the Cathedrals that are deep under the surface around 7 miles down.

With some of its energy now-depleted after recharging the Krystal Cathedrals, the heavy water at the bottom of the oceans that is found in pools and channeled by rivers on the floor then begins to slowly mix with the waters from above, imparting those cation ions with greater levels of anion ions for use in the *above* (surface) world. Those newly-charged water particles that blended with the Deuterium then rise to the surface and through evaporation will go through the complete cycle of life of water, where they will ultimately end up back in the oceans once again to be recharged to repeat the process.

This heavy water is essentially *liquid salt* and it is the *bath* in which CERN uses in *Bubble Chambers* to locate neutrinos turning into electrons becoming electromagnetic energy as mentioned multiple times. It is also synonymously referred to as *liquid crystal*. Salt *is* the first form of 3D energy we call electricity. Salt water has always been the source of ion energy used by the false gods since the invader races arrived, explained in great detail in the

SCIENCE OF THE STONE

previous chapters of the handbook. But as you will see here, they also knew about photonic or sound energy, putting a wrinkle in the explanations given in earlier chapters.

Limestone, which is effectively entirely *silica salt*, is **pure** crystal energy in stasis. In this form while still submerged, that water acts just like a massive rubber coating surrounding the flow of powerful energy particles carried by the Deuterium, preventing the heavy water from contact with direct sunlight until such time as those particles are properly diluted into the mass of the ocean's water it will now mix with before reaching the surface where solar waves can then safely activate or trigger it in very minute amounts to produce light and heat and gravity for surface life.

Pure Deuterium, or simply the water at the very bottom of the ocean, if placed directly in sunlight in this form, will detonate like a bomb. And while some limestones are a *perfect* crystal insulator, certain species such as Tura limestone also carry the unique ability to grow iron particles if it is presented with the right level of heat, **making it now *both a thermal insulator and an electrostatic conductor***. This is no minor miracle.

CRYSTAL VALENCE BANDS

Cheops SPOKE Pt 1

*Sonic or piezoelectric energy flows from a crystal's nucleus up through **frequency bands** called **valences**, which determine its pitch. One crystal placed directly onto another crystal becomes a single entity, viewed by science as a single molecule we will get into more as we go. The secret to this is known as **network covalent bonding**, which is a totally different thing than ionic bonding we find holds together normal atoms within the makeup of molecules that form the material things around us.*

Quartz crystals are not atomic, but are aetheric, something that leads science to state that while they may appear as regular material things, they are not, in fact, following the laws of Standard Model physics. This is because quartz crystals are the keepers of energy and are not bound within the one spacetime of this one dimension. You are about to learn that nearly every ounce of the Great Pyramid just so happens to be made up of the quantum of quartz crystal, from hundreds of feet below, all the way to the tip of its pyramidion.

PYRAMIDION INSULATOR CONT.

Realize that building a krystal energy generator out of natural materials requires that certain minerals be situated strategically throughout its structure to control very high levels of energy – on the magnitude of servicing cities with

SCIENCE OF THE STONE

as much demand as Portland for instance. There is no wiggle room here. One ERRA, and you have something on the order of a mega-ton nuclear bomb on your hands. Below the capstone of this energy generator we find that the outer casing is made specifically of *Tura limestone*, quarried from local sources in abundant quantity. It wasn't there just for looks.

On a *paramagnetic meter*, above-ground Tura limestone registers as flat as, well, glass. It isn't affected by a magnetic field at all, something on the order of near *absolute zero*, meaning that the *magnetite* that may be present in it from its ancient minerals is so well insulated, that it refuses to react to another magnetic field. This resistance is known as *dielectric reluctance* or *dielectric resistivity*. What it doesn't do, is refuse to respond to *thermal induction*. Thermal meaning heat, and induction meaning absorbancy. This is because limestone while in water, is one type of rock, and then when exposed to sunlight, transforms into a completely different type.

Limestone while still immersed in water, or still in sub-surface, is highly electrokinetic, or carrying an electrical charge having the capability of dielectric permittivity, which is a fancy way of saying it will conduct a certain level of electricity. However, once that limestone has been exposed to direct sun waves, suddenly this electrical permittivity disappears. This is called *metamorphism* in geo-speak, where a rock literally becomes another type of rock through heat or pressure, or all of the above.

Cheops SPOKE Pt 1

The Tura limestone used on Cheops is a special type of sedimentary rock that is prone to this transformation as soon as it is taken out of the water, then exposed to low thermal conditions. So “dry” limestone is flatly a non-conductor, making it incredibly effective as an insulator of an applied magnetic field. However, the limestone beneath Cheops that has not been exposed to the sun, still remains very much dielectrically reluctant, which means that it is a passive electrical conductor.

But limestone doesn't stop there with its ability to continue to morph into yet another type of stone altogether. As long as that “dry” limestone remains below 500C, it continues to act just like glass to insulate against electrical leakage, but over that is a different story. This means if the outside casing of the pyramid remains somewhat below crucible temperatures, this insulation is for all intents and purposes, absolute.

Once exposed to sunlight, Tura limestone now becomes a host to grow *goethite iron* when brought up to 500C temperature or higher. Tura limestone is made up of marine organisms that produce calcium carbonate for their hard exoskeletons known officially as calcite. Over time, calcite transforms into silicon dioxide, known as quartz. However, because this is an ongoing process where quartz limestone is forever growing through the addition of calcite, that iron can grow right along with the quartz eons later once it reaches direct sun waves.

SCIENCE OF THE STONE

Goethite is another word for *hydroxide*. And to the average person, that means nothing. But hydroxide just so happens to be the quantum ingredient of *rocket fuel* in solid form. It is a mixture of hydrogen and oxygen together that allows thermal reactions (ignition) in spaces where there is no external source of oxygen to react with hydrogen to cause a flame.

These are the same materials that make up Deuterium which is simply in liquid form. And naturally so would this limestone form around the flow of heavy water, since the pure concentrated hydrogen of Deuterium mixing with trace amounts of oxygen supplied by marine organisms that make up this protective barrier around the hydroducts, adds oxygen to the mix. In Deuterium's case, when exposed to sunlight, or simply elevated in temperature, it creates its own oxygen, making it rocket fuel that can simply be activated through the heat produced by any electromagnetic source that can be generated with a simple battery supply. And remember, all forms of energy can be used in many different ways. It doesn't have to burn to release that power through different forms.

Goethite is a natural crystal that produces *ferric iron*, or, a perfect natural conductor of electricity, but encased within a crystal shield as it were. There is no doubt that the level of energy funneled through the pyramidion of the Temples would be greater than 500C, turning our limestone *insulator* into a premium *conductor* of electricity which is

Cheops SPOKE Pt 1

prone to remain cool, dissipating heat very quickly. As you see, even though the same Tura limestone is used around the circumference of the pyramid, forming a “perfect” crystal insulator to hold in any energy bleed-through, the same stone used at different positions within the generator can perform completely different jobs. Below Cheops it is an electrokinetic conductor, above ground it is a dielectric non-conductor, and at the peak, it would become both a heatsink as well as an excellent conductor once again.

With this in mind, note that the size of the pyramidion of Amenemhat shown a moment ago is much smaller than the flat, level area at the top of Cheops, even if it were scaled up to Cheops’ size, meaning the capstone would have sat on top of something to become an uninterrupted peak atop the structure.

If the pyramid were to function as an *electromagnetic Dark Matter energy generator* (which it was at the time of its rebuild), then the “spacer” would have to have been made of a polymorphic limestone to act as both a thermal heatsink between the granite blocks that make up the main portion of the pyramid and the capstone as a thermal conductor to insulate the structure of the pyramid from the concentrated thermal radiation that would have built up at the very peak, while at the same time acting as a perfect electrostatic conductor to allow the energy from below to pass through to the pyramidion.

SCIENCE OF THE STONE

Without a heatsink, the heat generated from a metallic pyramidion would have allowed the temperature reaching the limestone casing to turn from an insulator into a conductor, thus melting the pyramid to the ground, or acting as a massive Tesla Coil, throwing out sparks hundreds of feet in all directions. The release of energy at this one minuscule tip could have been measured in megajoules:

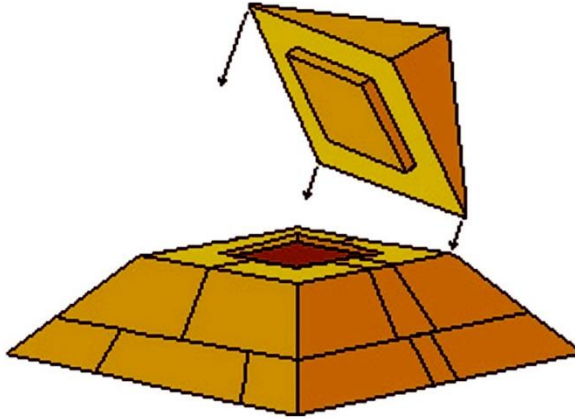

Weeks after writing this section of this report I tracked down a recent photograph of the top of Cheops shown previously to display the electromagnetic electrode set up under the ruse of being needed as an astrological measuring reference. Here is another look at that now, clearly showing the remnants of heatsink stones that would have sat below its pyramidion which is obviously white Tura limestone, contrasting against the red granite below. If this were not a machine, but rather simply a monument of one kind or another, there is literally no reason for these stones to all be

Cheops SPOKE Pt 1

uniquely different from the nearly 7 million tons of rock below that are otherwise 100% uniformly red Aswan granite:



WINGED SOLAR DISC

Ancient symbols carry *standing scalar waves*, and are coded to adjust the elements within the *specter* or *spectra field* to affect the DNA within the human body. This is not unlike wireless remote control signals that cause an RC car to turn here or brake there. And they do control your actions, even though these forces are unseen and conveniently largely ignored by science, going undetected. You have felt this thousands (millions) of times in your life, sometimes consciously realizing that your mood changed abruptly for no reason when you walked into a

SCIENCE OF THE STONE

certain room, not because of anything you could attribute it to. But there were paintings on the wall, symbols and codes on merchandise and people wearing certain jewelry with signets that you would never focus on that just changed your perspective without knowing it. If you think they get \$3,000 for a pair of sneakers or \$50,000 for a handbag without the right symbol emblazoned on it, you are mistaken.

The symbols now found on the pyramids of the ancient energy network were not there originally, but were added by the invaders from Sumer-Ur at the time of restoration to program the intent of perpetual enslavement willed by the fake gods, using icons that have been turned into *Command Signets* which speak directly to the aether to manifest reality. Here is a close-up of the capstone we are using as a model for what would have more than likely been similar if not identical to the hieroglyphs that would have been added to Cheops. The only way such flawless precision of accuracy and depth of this relief or shaping this stone could ever have been made in this material that is even harder than granite is laser or diamonds. Basalt is *twice as hard as bronze* and nearly twice that of *case-hardened steel*:

Cheops SPOKE Pt 1



Immediately below, we see the actual *Signet of Sumer* itself, the same Signet engraved on the pyramidion of Amenemhat which would more than likely also have been the much more ancient *Symbol of Atlantis*. Atlantis, represented by the *Eternal Phoenix*; “*the city that rises from the ashes*”, over and over again in perpetuity and against all challengers. (Note specifically this bird rises from “*ashes*” which is just another word for graphite, graphene and *zero-oxygen* in scientific terms.) This was the symbol of the *One World Order* that was instituted each time Atlantis was resurrected. And while this symbol slightly changes from era to era, each new replacement symbols carry all the power of the previous symbols, plus any new commands held within the updated Signet. In Sumerian times it was the *Winged Solar Disc*:

SCIENCE OF THE STONE



After the Sumerians took over Egypt, their gods were now Horus and Isis. The two snake heads as shown above later were depicted in some symbols with their two essences as one in the god *Janus* as shown below, born with both a male side and a female side to one physical body, the first form of the children of the fallen gods who would much later become known as *Adam and Eve*. They are part of the authorized symbols used to represent the two snake heads of the Phoenix.

Note the male has horns, just as Pan has been depicted having, just as Moses was depicted having, as well as Alexander the Great: the ancestors of the horned *Nordic* warriors of renown. The royal lineage of the Lulu rulers over Atlantis, Sumer, Egypt, Rome, Greece, and well, you will see here. It only takes a quick glance to tell that the

Cheops SPOKE Pt 1

female side of Janus is now recognized as the Statue of Liberty, previously first known as *Lilith*:



Whether two human-like heads are depicted or just one with another snake on its forehead as seen in Egyptian times, “Janus” can be male, or female, or both. Sometimes simply the wings (or horns as shown above) make it through prominently in their imagery.

SCIENCE OF THE STONE

This one being as two entities was known as the hermaphrodite Thoth/Hermes, the ibis bird-headed god (the Phoenix), also as a crocodile, dragon, Anubis, a lion, and other creatures from the klan of An. The wings have endured seamlessly down throughout time regardless and have been seen from Spain to Russia. They are masters of disguise in every way, from the names and titles used to the depiction of the entity, making it impossible for those unaware of the true history of the Sumerians to follow their breadcrumbs back through time.

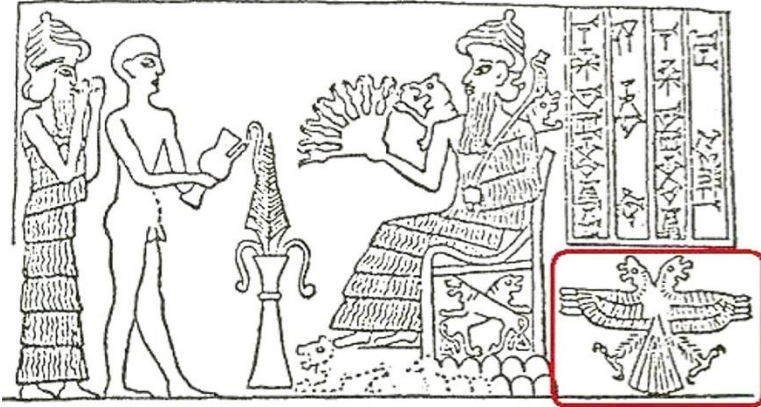

Ninurta, Son Of Isis, Babylon

Isis (ibis) of Egypt represented the winged half-bird, half-human with her mate affixed to her forehead and the “sun” above her head. The sun is the Urth over which she rules and is also the water dish of Wawwu that represented the human creation. Later that globe would turn into a gilded egg clutched in the claw of the Phoenix in subsequent symbols, and now celebrated the world over as ornaments on Christmas trees which were adorned to signal the rebirth

Cheops SPOKE Pt 1

of Osiris, the son and husband of the lady shown below. The horns to each side of the globe are the horns of the Bull of Utu, also known as Ba'al. The same horns now found surrounding many Signets today appear as leaves or feathers which combine both the wings of the Phoenix and the horns of Ba'al:



Once they moved from Egypt to Rome they were now the *Holy Roman Empire*:

SCIENCE OF THE STONE



They traveled next to *Jerusalem*:

Cheops SPOKE Pt 1



They went to *Greece*:

SCIENCE OF THE STONE



They went to *Sparta*:

Cheops SPOKE Pt 1



They set up shop in *Russia*:

SCIENCE OF THE STONE



They established the *Third Reich*:

Cheops SPOKE Pt 1



They became *The Vatican*:

SCIENCE OF THE STONE



They are now known as the *Freemasons (Messenes)*, among many others. You can look into the *officially registered trademark* of the Masons today if you like, and you will see that their claim, in writing, is the *Mother Council Of The World* (verbatim quote). It is impossible to explain all the hidden symbols inside this one logo that span across time and provenance, touching every facet of human existence. They are the *Holy Ghost* and H_2O (the most concentrated source of power on Urth) was literally named after them. You are about to see why there are two pyramids depicted below to explain how they went about enslaving the entire world:

MASON MILLENNIA PHOENIX 33 DEGREE SIGNET

ACTUAL DEUTERIUM
CRYSTAL NAMED AN→

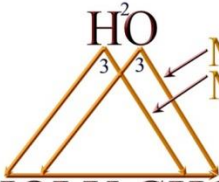

MILLENNIA
MESSENIA

HOLY GHOST

DEUTERIUM

↓ ↓ ↓ SALT ↓ ↓ ↓
DEUS MEUMQUE JUS



LEGAL TRADEMARK
MOTHER COUNCIL OF THE WORLD

DECODINGTHEHIVE.INFO

They never left *Egypt*, they merely expanded it:

SCIENCE OF THE STONE



In fact there are far too many examples to even show here, as the feathered wings of the Phoenix have turned into all manner today of plumage, from candlesticks and feathers of dragons to the fur and claws of lions (the original ancient Anunnaki who built the pyramids, now honored in all the lion statues found across ancient Egypt and around the world today), and many other floral designs, each one an iteration of the wings of the *eternal fowl*. (This is the *F-Owl* at *Bohemian Grove* where the elites still sacrifice virgin children today.) “All things winged” today are a creation of the *Anu-Elohim*, creators and ultimate gods of the *Jehovah Anunnaki*, the royal lineage of all invader races on planet.

Cheops SPOKE Pt 1

America was the first real reiteration of the splendor and glory of the rebuilding of Atlantis after the fall of Babylon, with the earliest coat of arms being adopted in 1776 when the continent was stolen from the early settlers by the *Sumerian Freemessenes*. The wings of the Phoenix are clearly within one of the squares to the right above center, and the two heads of Janus to the right below center, their overlord lions directly to the left, all overseen by the brilliant illumination of the Hermetically hidden pyramidion with the *Eye of Horus* keeping watch on all those below, now ONE (1) with the *Suns of An*, the children of the Anu-Elohim. Isis is on the far left, Horus Osiris, far right. And today, Isis stands as the mother-goddess welcoming the tired and poor, huddled masses into her arms, now referred to as Liberty instead of Lilith:

SCIENCE OF THE STONE

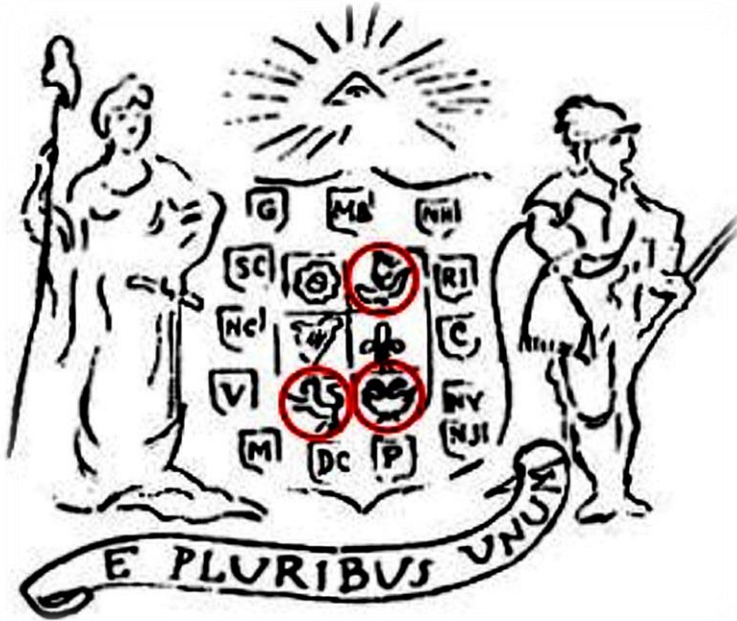

Later, the Phoenix rose in all her glory to the eternal Atlantis Phoenix under the *Thirteen Stars*, the ascended masters of the Michaelube, shining SUNS of Ba'al:

Cheops SPOKE Pt 1



The image of the great Winged Solar Disc Phoenix of the Anunnaki shines today through *billions* of Command Signets (flags and printed coats of arms) of the Elohim that each one perpetually radiates out the *measurable scalar signature* of the spell that was cast to keep all beings within the radiation field of each one under the holographically-inserted reality:

SCIENCE OF THE STONE



HORUS

MODERN GREAT SEAL

An claims to *unite all nations* today, just as he has done for many thousands of years. They are the estates of Kings (Khans) and the planet Urth is their *playing board* as depicted in the *Command Signet* of the *United Nations* (this is a real chess board called the *Noble Celts*):

Cheops SPOKE Pt 1



With the enormous energy generated by the pyramid below, emitting massively-powered standing scalar waves directly through the engraved symbol of the Winged Solar Disc of Sumer-Ur in the pyramidion key stone, the ultrasonic amplification of their Command Signet would now be multiplied by *trillions* of times to blanket all those within its field.

Restored in **5546 B.C.** the Global Cold Fusion Energy Temple Network was able to transfix with a clear vision before the eyes of the Egyptians, a world run entirely by the

SCIENCE OF THE STONE

fallen gods, ruling with a fist of iron. The *Michaelube Chimera Reality* now firmly planted under the impenetrable, seven-layered photoradionic shield of the *Zeta/Draco Quarantine Frequency Fence*. Today these scalar waves are still being equally as amplified through other mechanisms that took over once the grid was mothballed. That is another paper for another day.

For 252 thousand years, the Sumerian invader races have been grooming their royal Lulu hybrids to manage their day to day affairs for them, since they are able to move within the masses as if they are the very same species as actual humans. This is a seamless operation; where the gold miners of old now carry briefcases and wear suits (uniforms) and ties (An-ubis –ibis- collars with attached chains), but are secretly known as *the angels of the gods*.

They were once Horus and Isis and today they are Adam and Eve, the *angelic servants* that apportion out the funds that must be distributed each day to the *leaseholders* and to the *owner* of Tara Urth. You will see the fences that cordon off each one's kingdom in the *coat of arms* above in the United Nations Phoenix Command Signet. To us they are merely time zones, but to the gods, they are complete worlds, each with their own languages, apparel, cultures and curriculum and are run strictly by the *rules of the game*. Those zones are created by *sound* known as ultrasonic frequency fields.

Cheops SPOKE Pt 1

The clearinghouse agency where the funds generated by monetizing the various chattel across the interdimensions is called the *International Monetary Fund* where the wings of the Phoenix masquerade as olive branches while Isis is now a unicorn and the lion of Horus Osiris both guard the kingdom. The IMF literally rules the world today just as they have done under other names all along, hundreds of thousands of years prior to our current day:



Noble Celts global chess:

SCIENCE OF THE STONE



TERAHERTZ TIME-GRATED SPECTROSCOPIC IMAGING

Since it is difficult to believe such symbols, the letters on your screen, or the letters let's say in a book, carry their own spectrographic standing scalar waves (antiparticle photonic waves), I take the time to explain that this is now *mainstream science* when *MIT* researchers announced in late 2016 that through *Terahertz time-grated spectroscopic imaging* they could extract the contents of the *closed pages of a book*, proving that the letters inside, when struck by

Cheops SPOKE Pt 1

measured scalar sonic pulsations reveal scalar energy coming from each letter. The symbol O sends out invisible waves that the letter Q does not. The letter T is not an F or a +. Which means that when these letters, which are ancient transformed symbols now called our “alphabet”, stand alone or when combined, send out a radiation signature that is just as unique as a fingerprint.

As briefly touched on under Scalar Waves, this is known more specifically as *Terahertz radiation*, or *Tremendously High Frequency Waves* (THF), where the frequency band is microscopically fine, between .03 to 3 Terahertz:

*Wikipedia: **Terahertz radiation (THF)**;*

“Photon energy in the THz regime is less than the band-gap energy of non-metallic materials and thus THz radiation can penetrate such materials. THz beams transmitted through materials can be used for material characterization, layer inspection, and as an alternative to X-rays for producing high resolution images of the interior of solid objects.”

Of course we are talking here about *spectrography*, or the measurement of photon scalar radiation energy (the Dark Matter wave within the photon or ion), hence; *photoradionic* waves. This holds the form of whatever “thing” that light is supposed to hold at the time from “intent” that has been generated by a Sentient being, something we cannot get deeply into here, but explained at great length in previous chapters of DTH. All light waves

SCIENCE OF THE STONE

carry this intent to *hold the shape of a letter T* or *hold the shape of a Sumerian Flying Disc*, and can now, for the first time in modern science, factually be measured through *sonic spectroscopic scalar mapping*. Which means that the content of this paper is not based on mythology or superstition, regardless of how fantastic it might sound. Energy is not just electricity, and energy (power) *moves* particles. Since you are made up of particles, that means the human body is just as susceptible to remote or *external* control as *water in a stream*. But if you don't know how to make a dam or channel water away from that river, it is easy to dismiss the notion that anyone else could do that. Trust me, the ancients who are still here, did and still do know how to manage energy.

The reason why a scalar wave is able to reach each individual page of a book or layers in your body to identify the magnitude of the energy surrounding that shape or thing, is because scalar waves travel longitudinally while traveling outward, measuring each pixel in a precisely patterned grid as they go. By using the unique signature of each individual scalar gauge boson along the way within that vector, it is able to numerically map its course and isolate 345,822 atoms out or map in inches, feet, miles, etc., giving each pixel its own unique "IP address". There it measures the magnitude or force that energy exerts on the microscopic torus fields at that location. As mentioned, all things emit torus fields, either electromagnetic or electrostatic, so every quantum inch of space right down to the dust specks too small to see floating in the air each carries its own measurable velocity, magnitude, vector and frequency:

Cheops SPOKE Pt 1

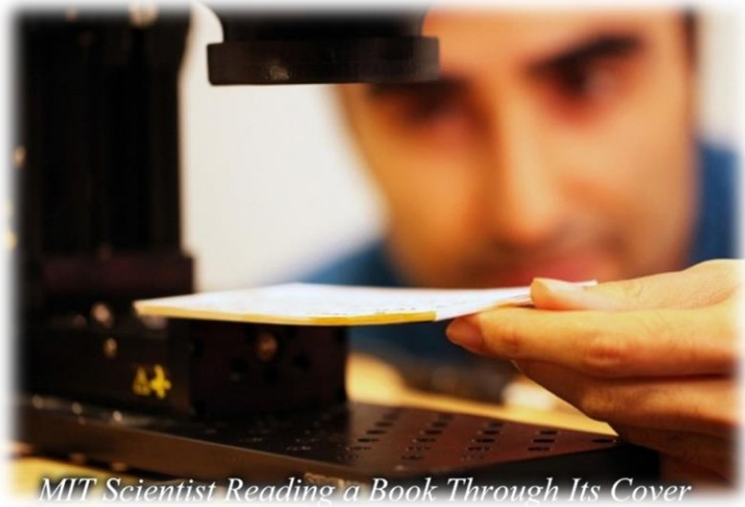

MIT Scientist Reading a Book Through Its Cover

CHAPTER 8

SCIENCE OF THE STONE



The cap stone to the pyramid of Amenemhat and almost certainly that of Cheops, was made out of *Basalt*, as we have recently covered. A very special, super-dense igneous “volcanic rock” that just so happens to be made up of over 75% rare-earth elements specific to photocathode optical refraction including *neodymium* used in zero-point antigravitic devices from perpetual motion machines and time crafts to magrav subterranean supersonic bullet trains.

Cheops SPOKE Pt 1

As will be further explained as we go, the *magnetically-charged cation ions* in the *crystal lattice* of Basalt carry a special characteristic, that when in the presence of an externally applied magnetic field, change from static, or pointing in random directions, to a unified direction. Only then becoming a conductor, allowing the transfer of energy, and *only* in the direction that the magnetic field is traveling.

As will be greatly discussed, this is *paramagnetism*; *para* coming from the word *paradox*, or *enigma*. It is also a super-dense, granite-like stone that is highly thermally conductive (dissipating), making it an unusually indestructible and ideal heat sink as well as an optical dielectric photocathode. In the scientific report below, it is shown not only to be highly dielectric, but particularly ideal in microwave (ultrasonic) band applications:

Some magnetic and electrical properties of Basalt rocks -M.S.AhmadA.M.Zihlif;

“The low-frequency results indicate that Basalt samples have relatively high dielectric constant. The microwave results reveal that relatively strong interactions exist between the microwave (in X-band) and the matrix.”

Additionally, it is also extremely high in silica crystal, the same material that your computer you are reading this with now uses to process energy, remembers trillions of bits of data on a chip smaller and thinner than your little

SUPERFLUID HYDRODYNAMICS

finger nail, and powers your smartphone under the name *lithium ion*. Its very fine-grain crystal lattice is the quantum of ash and graphite (graphene). In literal terms, Black Basalt, due to its low ion-count in its valence bands, is the *natural essence* of a *photocathode* which is electronic-speak for the term *black hole energy vortex* in astrophysics. More than just that, Basalt is a primary source for ormus, possibly the single-most coveted material in both ancient Egypt as well as today. Mono-atomic ormus gold is a highly prized and regularly-traded intergalactic commodity.

What those paragraphs above just stated could be likened to your carrying an electrical cord to a wooden fencepost, and by the electromagnetic field in the cord alone, turn that wooden fence post and the connecting rails around your field into an electric fence by the mere fact alone that you applied a magnetic field to what was once as insulating and non-conducting as glass prior. This is why paramagnetism is named after paradox, and not something we lightly skip over. We will come back to this subject soon in this chapter to explain the science of paramagnetism.

Each of these attributes are very significant and easily overlooked if you were merely looking at it like it was a normal rock in your yard you whitewash to line your driveway. The minerals in the specific species of Black Basalt used as pyramids in the Energy Temples are among the most powerfully-guarded noble metals on Urth already touched on. Make no mistake, purchasing any amount of this stone greater than a necklace pendant will put you on the FBI's *potential terrorist list*. You will see why as you

Cheops SPOKE Pt 1

learn more about the minerals that make up Basalt. If you have already read the previous chapters of DTH, you might already know why this “stone” would be named *salt*.

NEODYMIUM

Neodymium stands for rare-earth magnetic, eternal, free energy that comes from *magnetite* (the little crystals that hold a permanent magnetic charge). Magnetite is a real, “natural” stone, in that it physically grows from magnetite crystal within certain mineral deposits in the ground:



SUPERFLUID HYDRODYNAMICS

Neodymium is a second generation composite of what was originally called *Samarium magnets*. The name Samarium is the same name *Sumerian*, or where this technology actually came from, at least in this most-recent installment of human civilization.

All Sumerians (the “gods”, not the humans they killed or enslaved to steal their lands and identities) are Anunnaki, of which there are over 50 differing sub-species hybrids. All of which are termed collectively as Anunnaki.

*Ancient Anunnaki ancestors built the original pyramids as already covered, and Anunnaki Resistance members rebuilt them 7500 years ago. You will see why the capstones were shaped exactly as they are, and why magnetite would have originally borne the name **Samarium**.*

Discovered in 1885, *neodymium* is most concentrated in its natural form in both *monazite* and *bastnäsite*. Bastnäsite being the purest and richest source for *rare earth magnetite*, or the “magic crystal” that carries the power of

Cheops SPOKE Pt 1

magnetic energy. Bastnäsite was named after the mine in which it was originally found in Bastnäs, Sweden. The Bastnäs mine, now famous for its high concentrations of rare earth materials is actually a huge deposit of **Black Basalt**. The name *Basalt* would almost assuredly have come from the prefix *ba* from *Bastnäs* added to the word *salt*, as salt is the most well-hidden secret behind power, energy and rule.

And as far as valuable stones go, Black Basalt, at least of the species used in the pyramidion of Amenemhat which was quarried from the ancient Giza plateau next to the Cheops complex, is extremely rich in *noble* metals (a code word for the most precious minerals found on Urth) which is virtually synonymous with money. It is so hard and dense, that even in modern times is extremely difficult to cut, landing on the Mohs Scale at 8, where diamond is at 10.

Even more so than the granite that makes up the bulk of the pyramid itself which lands on the Mohs Scale at 7, it would have been impossible to quarry into smooth, planar surfaces using the hand tools history claims were merely bronze that the Egyptians had to work with. This is a fantasy, as bronze only reaches about 4 on the Mohs Scale, which would be like cutting down an oak tree using a loaf of bread for granite and like using a dead fish to cut Black Basalt.

SUPERFLUID HYDRODYNAMICS

In response to the preposterous claims from historians (and expounded by Egyptians) that the builders of the pyramids were merely working with rudimentary technologies to accomplish these feats of impossible achievements using such hand-powered bronze tools, just the fact that this pyramidion which is far harder than most *metals* has been precisely cut and perfectly polished in flawless geometry alone proves beyond any empirical doubt that the pyramid builders not only were far beyond the “bronze age”, but were clearly equipped with technology that exceeds those possessed by modern man, as evidenced by innumerable archeologists providing countless images showing many stones in the pyramids (that weren’t poured into shape using geopolymer resin) were clearly quarried using cutting blades we’ve never even seen before as verified by the saw blade patterns clearly visible on many stones where each revolution removes 10x the material as we are able to achieve today.

Had they used saw blades to make such cuts, some would have had to have been *20 feet in diameter* or more and travel without distortion using a *razor thin blade* rotating at *many times the speed* we are able to achieve.

They have demonstrated also in overcut stones (stones that were below the one currently being cut out of the quarry) and perfectly cylindrical holes that are physically impossible to achieve with anything other than a diamond-tipped hole saw under pressures *we have never achieved*. Grinding out holes in stone using other stones cannot leave perfectly-defined overcut saw blade marks around the

Cheops SPOKE Pt 1

circumference at the bottom of a Forstner cavity. No laser on Urth can duplicate the cylindrical cut shown below. (Note the perfectly cylindrical and vertical recesses of the upper portion that was once completely *inside* the hole, displaying clear evidence this was once a sonic resonation chamber, complete with planar dynodes we will be getting into shortly.):

Granite:

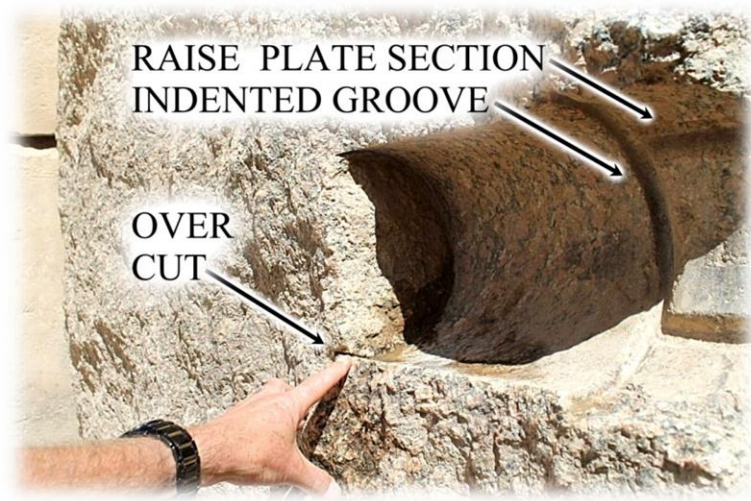

Basalt. Sawblade marks leading down to a precise horizontal finish:

SUPERFLUID HYDRODYNAMICS



Basalt. Overcuts impossible to reproduce by hand tools and rather pointless:



Cheops SPOKE Pt 1

Basalt:



The capstone of the Amenemhat black pyramid is the *natural* form of a **massive neodymium magnet** that will withstand eons of weather and never corrode, as its active minerals are encased in super-dense, super-insulating rock that can withstand intense levels of heat under extreme thermodynamic applications. The stone that is encasing this incredibly powerful magnetite crystal is like a plastic case protecting your smartphone, but in this case, giving it the ability to stand in sun and rain effectively forever. The radioactive isotopes within Black Basalt have a half-life of 10 million years. Coincidentally, the most valuable rock ever found, the *Rosetta Stone*, was also made out of this very specific, highly indestructible stone called Black Basalt. And while it is called an igneous rock (created by

SUPERFLUID HYDRODYNAMICS

volcanic magma), this is not entirely true. While some isolated caches may have later melted under magma temperatures, the original Black Basalt was once the pure crystal fibers of once-miles-high pure silica trees that were covering the Urth before the Fall of Man War. The harder the “stone”, the larger the tree. Many the size of very large mountains:



Cheops SPOKE Pt 1



Basalt Tree Stump



Fallen Basalt Tree

Now you know why the quantum of the highly silica, highly paramagnetic, ultra-optically-sensitive crystal lattice structure of Basalt is ash, because it is actually crystal wood fiber that once held the form of trees that were miles tall in height and the circumference of giant mountains:

SUPERFLUID HYDRODYNAMICS



In the case of the mountain above that was actually once a monolithic tree however that may have been as tall as 30 miles high, this one was also hewn into an unthinkably gigantic pyramid, producing an Energy Temple that actually reaches up *above the clouds*:





Devils Tower Monument, Wyoming

QUANTUM LOCKING LEVITATION

A neodymium magnet will *levitate perpetually* over a superconductor through what is known as *quantum locking*, or *quantum levitation*. This is not news that levitation is real. Science and the public interested enough to look at it have known about this for decades, even in mainstream. Zero-point technology isn't a matter of science fiction, but science fact. Here a neodymium magnet remains fixed in one place above a superconductor holding the temperature of just over absolute zero:

SUPERFLUID HYDRODYNAMICS

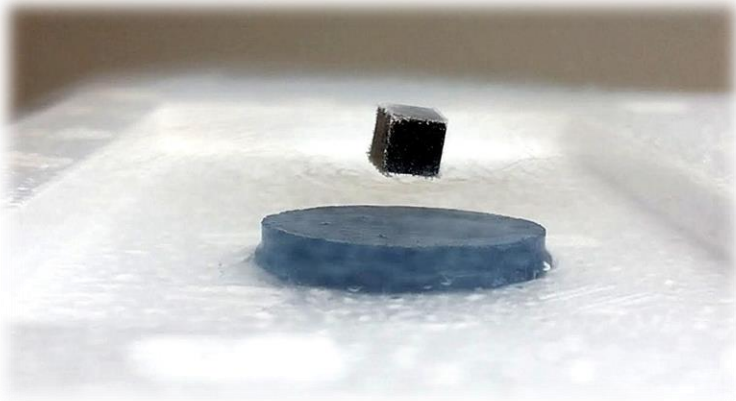

We are going to be covering the science on how this is accomplished, not because the pyramids levitate, but because the technology of producing a zero point field is the foundation of the principles used to move energy without speed limitations within the Energy Temples. Here we go.

MAGNETITE LEVITATION

Magnetite, also known as *lodestone*, as in *the* motherlode, is the crystal species that carries rare-earth magnetic properties neodymium is made out of. Standard Model modern science which is based on magnetic energy uses the delta symbol ▲ and lambda symbol ▼ so often, it is difficult to describe. It stands for every important characteristic of energy before and after it has transmuted from subatomic neutrinos into ions which then makes energy something we can work with in the 3D world.

Cheops SPOKE Pt 1

These magnets are so powerful, a 5 pound neodymium bar placed next to a metal surface will *squirt* a human hand out like water from between the bond. More than stunning, the natural shape of the magnetite crystal just so happens to be the same exact shape and within almost flawless tolerances of the geometric, equilateral, golden-ratio Cheops was built. If you think that the shape of a capstone or a pyramid was a hapless form that suited the architects' available materials, think again:



Then there is the coincidental shape of the most effective solar-energy collecting silicon conductors as shown here in this microscopy image of a photo-voltaic solar panel cell. Natural silica that silicon is derived from is coincidentally also what the pyramids within the Ultrasonic Energy Network happen to be made out of from top to bottom:

SUPERFLUID HYDRODYNAMICS

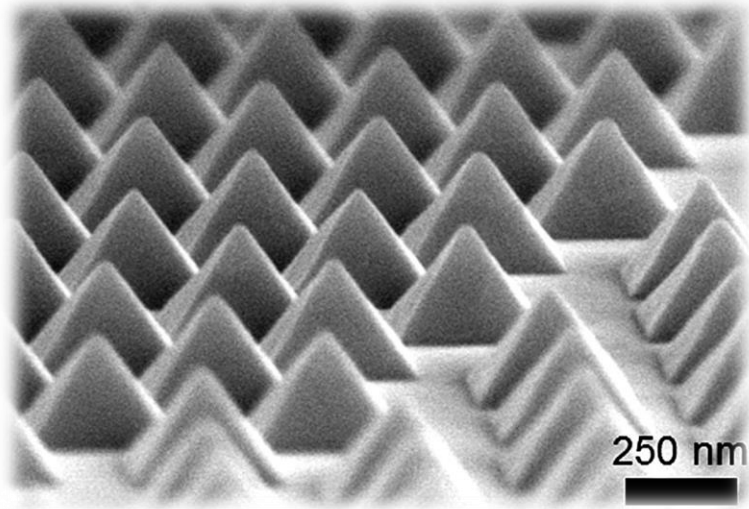

LESTER'S COME TO JESUS MEETING

There has been constant speculation since the 1970s when flower children (hippies) became aware of crystals and pyramids both being of some magical value to their bodies and to their spiritual growth to what they termed *Love* (which is another Program to be covered at another time). Many studies have been conducted on the subjects, and while it never seemed to come fully into view where these energies come from or what they do exactly, it has been conclusively determined that both are excellent for human healing as well as harmonizing to all things in nature.

Cheops SPOKE Pt 1

Physicist *Les Brown* spent his life dedicated to these two phenomena, going so far as to build his home in the shape of a pyramid:



He admitted to knowing something about the energies from crystals and pyramids that he didn't learn in this lifetime that prompted him to his investigations, trying to unlock the full extent of his understanding on the matter. In some way, to Lester, pyramids were secretly crystals, but he didn't know exactly how that was, or why he felt great harmony and peace while inside his pyramid conclave. But to him, they were connected in some way and he was going to find out how.

SUPERFLUID HYDRODYNAMICS

Les decided to perform an experiment on his home while in the process of connecting the two disparate-yet-somehow-connected objects, the one being the pyramid shape and the other being the crystal that produced piezoelectricity from nowhere. He already knew that by using copper wire wound around a crystal, he was able to measure electromagnetic signals, so crystals had actual electricity inside them. And he knew that pyramids had amazing powers that could extend the life of things, even the sharpness of the edge of a razor blade. So perhaps by connecting copper wires to his house, he would get the same small current held inside crystals. And, as logic goes, this was actually right on the money. Sort of.

So he placed a wound coil of copper wire attached to the peak of his home spiraling in a cone-shape downward ▼ (which concentrates energy). Then he placed another one centered to his pyramid on the ground floor some 2 stories below, pointing upward to the other spiral ▲. He also grounded this coil directly to Urth through his floor. So far, nothing. His idea then was to connect the two coils together to create a small arc, but not using copper wire. For some reason his intuition from what he'd learned so far, or from past-life memories, told him he should use sheep's wool instead. He likely never figured out why he used wool fiber instead of just running a bare copper wire down to that other coil. Or perhaps he did, I can't tell.

Before getting to his experiment's conclusion, let me explain that wool is hair. Hair is crystal. It is the body's crystal sonic connection to the aether. And when I say

Cheops SPOKE Pt 1

aether, in this application that means energy. All incoming information as well as power is contained in a quantum-connected state called the *unified field* in science. All sound waves, light waves, heat waves are transported from one point within the spacetime fabric to the other instantly. They may only be perceivable to your senses “10 feet away” that the heat or light travels, but within spacetime, they are universally at every point within the entire fabric at the same moment. (Technically, the aether transports or broadcasts this event 3 seconds before the event actually occurs to our normal senses, something that has been demonstrated conclusively thousands of times in the Quantum Mechanics *Double Slit Experiment*.) Your hair and animal’s hair are the crystalline strands that grow on the body to collect these sounds which resonates into your incoming-signal center, which is the top of the head for females and the pelvic region of males, as they are opposing energy fields to each other.

And under a microscope, this is clearly apparent that hair is a telescoping chain of cylindrical calcium crystals that when in this exact shape, such crystal is highly sonic-sensitive. Hair is your body’s “Pi” (piezoelectric) crystals. Meaning they hear sound, amplify and then repeat it on the other side. We’ve already seen the inside of a human hair earlier, showing it is not just hollow, but filled with hundreds of continuous hollow resonance chambers. Together they act like individually-tuned pitch-pipes of a musical organ. Here are the ones that grow inside the Cochlea of the human ear that are responsible for detecting sound, amplifying that signal, then sending it to the brain:

SUPERFLUID HYDRODYNAMICS

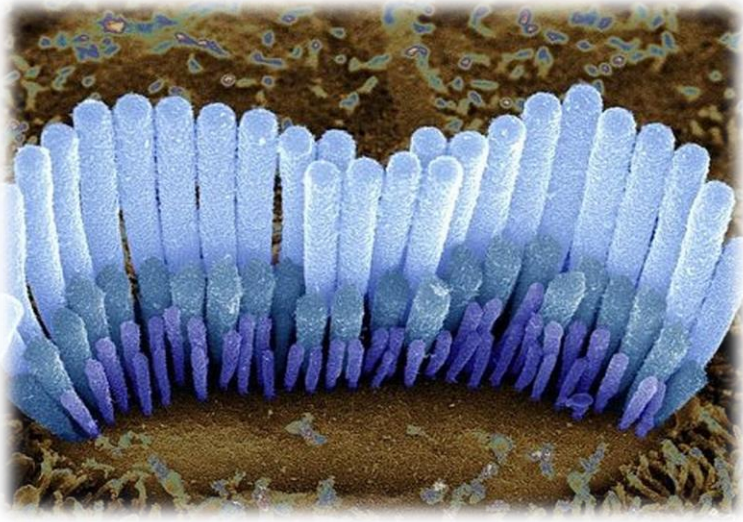

The same silica crystal wafers like the layers of your hair are used in microphones even today to pick up your voice or any other audible signal. In this application, quartz crystal is cut into very thin slivers or *wafers* that can pick up even the most delicate sound vibrations then rebroadcast that signal on an amplified level, without any other electricity powering it. Static audio earplugs use crystal to do this very thing. Hair grows in wafers of crystals, one after another continuously so even when it wears off or gets cut, it will always grow back, keeping your body in tune to all things. The longer your hair, the more powerful signals you will receive:

Cheops SPOKE Pt 1

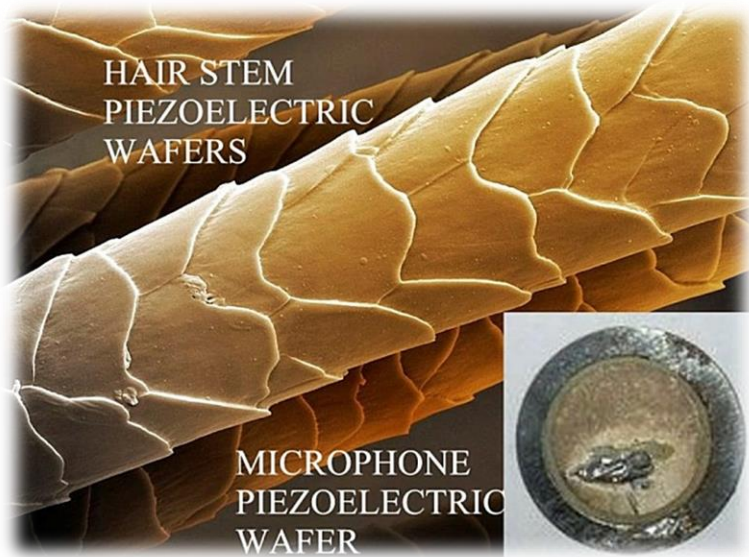

This is the same thing your fingernails are made out of, and why when static electricity jumps from the doorknob to your hand, it often enters your nail and why lightning bolts strike your head if you are in the wrong place at the right time. They are your “wire” connection to all forms of energy, but only under high levels of amplitude do they become your “electrode” point where electricity flows in or out. Otherwise, they move this energy without the *secondary emission* electromagnetic zap.

So wool is *flexible quartz crystal wire* for want of a better term because energy is literally sound. If you want to amplify that sound, using resonance chambers is the obvious choice. The amplification process produces secondary emissions naturally, so now the free ions push that signal outward.

SUPERFLUID HYDRODYNAMICS

If you were trying to connect two crystals together, wool or optical fiber will act like running electrical cords between. The difference is, wool, or hair, while flexible and easy to work with like braided copper wire, doesn't act like a metal wire to transfer electromagnetic electricity through it unless that energy exceeds the amperage your body is designed to use (your electrostatic field). The hard silica shell allows crystals to speak to each other (pass electrical current) directly, while keeping the electric ions in a state of insulated stasis.

As soon as you introduce a conductive metal into the equation (such as the copper wire that Les had mounted to his ground floor and peak of his house), that turns anion ions into Dark Matter electrons which then readily flows immediately into the atomic crystal valence of that conductor. As you know by now, this exposes that form of energy into the open air where it is free-flowing in all directions, causing the electrons to go ballistic, slamming into each other, spewing thermal radiation everywhere. And that is when damage occurs. As long as that energy was in the wool, or if it were being channeled into an insulated wire with its connection shielded, it would remain contained.

Realize that the human body is an electrically-charged thing. Just like a battery-powered radio. Since your body excretes iron, you are carrying magnetic energy, however faint. This makes you a conductor of electromagnetic

Cheops SPOKE Pt 1

energy, even though you don't have metal plates covering patches of your skin. And on occasion, if the electrons in your field become too highly-charged, it will discharge that secondary emission of Dark Matter energy away from itself exactly like clouds that send its excess negative ions directly into Urth through a conductor (like through you or a tree or weathervane). If you touch someone who's frequency field is harmonized to yours (like matching crystals), then you can transfer this energy, or even by just standing close to them. The one with *excess anion ions* will send out the secondary emission and the other who has less will be on the receiving end of the static electrical discharge (secondary energy).

But whenever you experience an actual zap, it is always excess Dark Matter electromagnetic energy you have picked up from electromagnetic fields around you, turning back into stasis energy *by connecting to ground*. When you transfer negative ions from one to the other, there is no spark associated with the exchange, so all you feel is more energy while you are around that person.

Certain bodies, such as Indigos, produce thousands of times more anion ions than others do, so when they are in the room, the air naturally becomes "electric", heightening the senses of everyone else. Such people hire themselves out as "guests" at high-end parties just to infuse the air with more energy, keeping the guests more alert (this is an actual thing). The difference between these two forms of the same energy can always be identified by the spark emitted, or the lack thereof, at the time of the transfer.

SUPERFLUID HYDRODYNAMICS

Now let's get back to Lester and his experiment.

Not knowing exactly why he was attempting to short-circuit a giant pyramid, or even why a pyramid would have free-flowing energy build-up inside of it, he attaches one end of the wool "wire" to the top coil, then walks down to the bottom floor to tie it onto the top of the copper wire to his floor that was also directly grounded to the soil below with additional grounding rods. As his one hand was holding the wool, his other was reaching for the bottom coil, which now became an electromagnetic cathode. An arc of electricity bolted into his outstretched hand, connecting the negative end of the pyramid to the grounded (positive) end, and sent his 180-lb body 20 feet across the floor and into the wall, cleanly removing the skin from both his right leg and right arm in the process, leaving him dazed on the floor, wondering what in the hell just happened.

After careful ponderance and deliberation, which likely lasted about a minute once he came to, he carefully removed both coils and swore never to f@!& with mother nature's pyramid power again. Which is sad, because Les was this close to breaking the code.

The pyramid *shape* is a *geometric Command Signet* that tells aether energy where to land in aviation-speak. This language, as will be much further discussed in the **S@t@in CϣphΞr**, can be referred to as the cellular language of the

Cheops SPOKE Pt 1

aether. The universal geometric lexicon of sub-quantum science. This is why modern science still uses the pyramid to refer to the forms of “energy particles” that represent the god particle and any actions of energy that has to do with its transformation from stasis energy into Dark Matter and vice-versa. Crystals grow into pyramid shapes naturally at their positive ends, just as magnetite does called tetrahedrons and square pyramids. The exact shape of the *planar face* of each “facet” tells the aether how much energy to store within that crystal (capacitor) species. But in the case of the perfect square pyramid geometry as seen earlier in the close-up of magnetite, an equilateral, 5-point pyramid is the symbol that represents the most energy (anion ions) to place inside that geometric design per atom. Lester’s house was that exact shape on all 5 planar surfaces, meaning he was standing inside the nucleus of a magnetite crystal the size of a building.

It doesn’t matter what material makes up that geometric image. It can be copper, wooden sticks, pencil lead drawing it out, or even on your computer screen. This image will have the most powerful electret-magnetic signature of any geometric shape within the lexicon.

By now you can see magnetite grows into this shape for the very specific reason of carrying the essence of not just crystal energy (piezoelectric), but highly concentrated anion ion magnetic crystal energy. And while a magnetite magnet does interact with ferro-metals, until that time, that energy is merely sitting there humming to itself below your perceivable hearing spectrum. Since it is in a perfect-spin

SUPERFLUID HYDRODYNAMICS

Triplet State (the Higgs Boson state), it is spinning at a “perfect pitch” in relation to the harmonic frequency of your DNA, meaning it won’t damage your genetic template, and will even go about putting your DNA back into its own unique, perfect resonance pattern it was coded with before all the distortions began under your enslavement. Hence, its perfect harmonic spin does in fact heal. Both regular people, and hippies.

So Les had called the aether energy to come and accumulate inside his home which turned it into a giant cation ion begging for energy from the surrounding negatively charged ions in the air by sticking to the correct geometric language of magnetic power, and then attempted to turn Triplet State stasis energy into Dark Matter by using copper wire instead of sticking entirely with wool crystals. On top of this, he decided to short circuit that massive crystal with his own body just to see what would happen.

What happened was 3000 square feet of pure raw ionic energy crowded around the peak of his home, transformed into Dark Matter in the copper coil while more than quadrupling itself in amperage through secondary emissions, went through another magnetic dipole moment back into the crystal wool which amplified it again, filled his body with about one millions times too many ions which doubled that energy again and sent a lightning bolt out of his outstretch electrode arm which broke down the air around him, causing the spark to reach open air, striking another oxygen-free metal conductor that more than doubled his energy again through another secondary

Cheops SPOKE Pt 1

emission, causing the Urth to send up a ground-to-cloud secondary emission lightning bolt to meet him to complete the circuit, turning Lester into a 180lb light bulb filament.

SUPERCONDUCTORS 1, MAGNETIC FIELDS

Remember, a magnetic field is completely suspended (cancelled) when in the presence of a superconductor as mentioned previously, resulting in the stone or *neodymium magnet* to levitate. This is a very crucial part of the secret of how the Energy Temples generated enough energy for its intended purpose. Also keep in mind that this phenomenon of quantum levitation is also called *quantum locking*, which “connects” the two (with space in between), that works if the superconductor is below or above the magnetite, causing the suspended magnet to follow wherever that superconductor goes.

If I were to carry a superconductor in my hand that was in the sonically-balanced harmonic resonance of a rare-earth magnet, or a stone with magnetite (neodymium) that was part of its makeup, I could walk that magnet or stone to wherever I wanted it to be regardless of how much it weighed, because its weight is totally zeroed out, not suspended by the thing (my hand) holding up the superconductor, but entirely by the *superconductor itself* in zero gravity, because as you will see, the magnet and the superconductor, become one. Both then suspended outside

SUPERFLUID HYDRODYNAMICS

of the gravitational field. A stone weighing a million pounds would be just as easy for me to relocate as one that is an ounce. And as long as that superconductor was in my hand, I could tip it to any angle -even upside down- that I chose, as it would weigh *less than nothing*:



The “space” mentioned that is between the magnet and the superconductor is what is known as a *zero point*. Or, the point where gravity is suspended from the laws of physics. And in the creation of that space, the torus sphere that surrounds it is equal to the distance of the outer-most edges of both the superconductor’s valence and the magnet, meaning they too are within the zero-point field. In that *space*, time doesn’t exist and gravity doesn’t exist. Not explained by modern science, this is the “back door” or escape hatch where the sentient entity powering that “mission” to manifest something for the observance of a human in material manifestation (you), is able to remove

Cheops SPOKE Pt 1

their awareness from that “place” in spacetime should they choose. More on this in vols 1 and 2 of the handbook.

Not only were the pyramids of Amenemhat and that of the missing one from Cheops rich in natural magnetite, which is specifically *paramagnetic*, but so are other portions of Cheops. And for very good reason.

So what is a superconductor? It is a medium that allows electricity to pass through without any form of energy loss. Metals, such as copper and iron, are great conductors of Dark Matter electricity; however the oxygen molecules still left inside metals (though this count is low) cause a barrier called *electrical resistance* to slow down this flow, which results in heat called *thermal resistance*. Your toaster has metal coils inside that heat up while Dark Matter flows through which toasts the bread. If those coils were superconductors, your bread would remain just as cool and untanned as when it was fresh-cut into slices.

Currently *mainstream* science has only been able to achieve superconductivity at extremely low temperature rates that make it impossible to use on a wide scale. This is because they are using graphene, graphite and other absolutely oxygen-free materials reduced down to extremely cold temperatures. A *room temperature superconductor*, long deemed the *holy grail* in quantum science circles, relies on *paramagnetism* to create *Cooper pairs* that would create a *Meissner Effect* (explained in a moment) that

SUPERFLUID HYDRODYNAMICS

“theoretically” would facilitate this miraculous energy transfer within normal working temperatures from -200C and above. The superconductors we know of today (those subscribing to mainstream scientific papers) only work within .01 to 3 degrees minus zero Celsius, called *absolute zero* which is -273.15°C .

Understand that the reason they are reducing the temperature is to overcome the fact that Dark Matter energy carries with it thermal radiation (heat), so the only way for them to send that inverted energy through any substance is to first erase its energy signature, signaling to the aether that this is now energy that is allowed to process on a quantum basis throughout the spacetime fabric. Otherwise, open flame would then be allowed to be everywhere all at once, eliminating creation. Until then, Dark Matter is strictly limited to “the speed of light” or below, which, like a forest fire is unable to burn up an entire forest all at the same time, it must travel through mechanical limitations in order to propagate. Real superconductors of Light Matter that have secretly been in use around you for almost a century have no such limitations.

SUPERCONDUCTORS 2, THE MEISSNER EFFECT

A superconductor also carries the properties of expelling from it, or *pushing away*, all forms of *magnetic* energy,

Cheops SPOKE Pt 1

both Dark Matter and Light Matter that is not harmonically tuned to that material. This is the quality of *antigravity*, where a *zero point* is produced between two fields known as the *Meissner Effect*:

Wikipedia: Meissner Effect:

“The Meissner effect was given a phenomenological explanation by the brothers Fritz and Heinz London, who showed that the electromagnetic free energy in a superconductor is minimized provided

$$\nabla^2 \mathbf{H} = \lambda^{-2} \mathbf{H}$$

where H is the magnetic field and λ is the London penetration depth.

This equation, which is known as the London equation, predicts that the magnetic field in a superconductor decays exponentially from whatever value it possesses at the surface.”

The Meissner Effect is supposed to explain how levitation physically works using scientific equations on a particle or atomic level. It doesn't explain how it is that there is such a thing as antigravity inside of a gravity plane (when this is clearly happening inside the immediate supposed -yet fictitious- gravitational *pull* of Urth). Plus it deliberately chooses certain words to throw into the explanation just to guide your *understanding* that magnetic power is subject to decay. This is untrue. It never decays and the “particle” doesn't harm or kill any other “particles”, such as equated to decay, it is merely inverting that element out of the realm of materially manifested “matter” from this one

SUPERFLUID HYDRODYNAMICS

interdimension of the holographic playing field. Again, an incredibly insufficient and deliberately distorted explanation offered by science to show you what zero point really means. Within the structure of a superconductor that defies the laws of physics (just like the *Triplet Spin Higgs Boson*), are other fields at work as well that combine with this attribute to create further phenomenae.

SUPERCONDUCTOR 3, GRAPHENE

Very recently science has learned that *graphite* joins the fray of superconductors, in that it can be used to levitate neodymium magnets, as shown here:



Cheops SPOKE Pt 1

Graphite is a somewhat less pure form of *graphene*, and though it doesn't allow *Cooper Pairs* (electrons holding hands while in stasis) to pass through as well as graphene, still it is of a *crystal lattice structure* that allows them to pass with far less resistance than say, copper or other metal conductors that have much greater quantity of oxygen in their valence bands.

Even more recently, science has now discovered that *graphene* in a superconductor allows Cooper Paired electrons (covered in a minute) to pass through faster than what was previously thought they could travel. A *lot* faster. In fact their flow through this ultra-conductor is termed ***superballistic conduction*** through the similar flow of *superfluid hydrodynamics* as used in some of my inventions in the past which we will discuss soon.

This is the quantum essence of ash, or oxygen-depleted wood fibers that are octahedron or a *square bipyramid*. Remember this shape, because you are about to see why it is two square pyramids connected are used in the most delicate optical applications, and realize that when you are talking about photon energy, you are talking about optics which is the way sound broadcasts through resonance chambers. The flat planar surfaces and sharp edges on these connected cones won't seem like resonance chambers nor seem very important to you now, but they will:

SUPERFLUID HYDRODYNAMICS



SUPERCONDUCTORS 4, PARAMAGNETISM

Paramagnetism means that the magnetite crystals inside the *atomic crystal lattice* of the stone or material are not pointing in any one direction; just like the energy crystals in water we call *electrolytes*. However, once in the presence of *magnetite* (unidirectional) or other *applied magnetic* force, those crystals all turn pointing the direction **of the flow of energy**. So if they are in the presence of the negative end of the magnet, they will point the same direction the magnet is pointed, and vice versa. Until under such an applied magnetic field, the microscopic crystals held in heavy water Deuterium covered in great detail in previous volumes, are switched off as it were. This is what

Cheops SPOKE Pt 1

I refer to as stasis and science refers to as neutral, or dielectric. Dielectric stone resists a magnetic field, which makes it difficult to coax energy from its atomic core. The stronger the magnetic field, the more that stone's resistance or *reluctance* breaks down.

The enormous energy potential held inside *paramagnetic heavy water*, which is pretty much like a super-concentrated salt bath (salt crystals being battery-like cation receivers of ion energy you know as capacitors), is merely sitting there, like a battery on your counter ready to be recharged which begins the very moment it reaches sun waves. In Deuterium's case, this is an instant charge that happens only when that liquid is meant to serve the hologram of surface-Urth that begins above the ocean floor. Below that, Deuterium provides the weakly-oxygenated ions used by deep-sea marine life.

When a neutrino carrying the "magic" element of *stasis magnetic energy* inside strikes that Deuterium particle in cation/proton state, it creates a tiny spark that turns that particle into *polar magnetic*. Once this happens, now that stasis photon energy becomes electret-magnetic energy and can begin interacting on a much grander scale within the upper 3D hologram. This form of magnetic field surrounding crystals and Dark Matter electromagnetic fields from a mechanical generator affect paramagnetic stones in the same way:

Paramagnetic Materials

The behavior of a paramagnetic material under the influence of an external field



The unique “stasis” form of magnetic energy is the secret to the superconductor, in that once a magnet comes into the *field* of that stone, then the magnetic crystals in its atomic lattice now *combine* with the magnet, *supercharging* the energy force of that coupled field. However, the only form of energy that it allows to process with zero friction is Light Matter ions. While outside of audible range, this is still “Saser” energy or sonic waves. That energy can be turned into Dark Matter coming from that superconductor, but only once it has exited.

Once the two forces of the superconductor and a magnetic field combine, where the zero-point of the superconductor “turns on” the magnetic crystals in the paramagnetic (stasis) stone, then the energy of the magnet is transferred into the superconductor, just like a *capacitor*. As we have already touched on, this is *sympathetic harmonic resonance*

Cheops SPOKE Pt 1

across a distance which is the same thing as network covalent bonding when they are physically touching. The only difference is, the magnetic field is strong enough to make the leap and two crystals without that stronger magnetic field must actually touch.

A capacitor, which is always carbon-silica crystal, is able to store very high levels of energy so they can be released to begin an energy flow or light up an area with a very bright flash from your camera. Superconductors are shown to be able to “absorb” any level of energy within its field. Which could be one magnet’s energy, or thousands. All that needs to happen to complete the circuit of the magnet’s energy passing *through* the superconductor, is for a conductor (iron, copper, gold) ***tuned to its resonance field*** to be placed parallel by its side to allow those energy “particles” to *tunnel* through to the other side in stasis form they call *Cooper Pairs*.

The secret of *neutrino events* referred to as creating a new ion which is then able to function within the material world of atoms and molecules is the imparting of oxygen. After extensive research into the phenomenae of magnetic energy, I can say without any hesitation now, that oxygen is literally energy itself and without it, no material thing would come into view. Because “oxygen” is the *birth* of the Aniline crystal, or the seed to all crystals at its inception through a physical spark that can be seen at the time of the event, and its *rebirth* in the subsequent sparks seen each time it is recharged by sun waves through photosynthesis. In scientific terms, that spark can only be equated to the

SUPERFLUID HYDRODYNAMICS

breath of life. Just like each spark created by a thought inside the human mind that creates an entirely new universe each time, it is breathing life into that creation.

*This means in the simplest possible terms, electricity or energy is oxygen and the lack of oxygen such as **hypoxic** graphene, graphite, sulphur or ash is the sponge that calls out to that oxygen.*

*That makes **cation ions** in their most depleted form directly equated to **graphene**; and **anion ions** in their most charged form, **magnets**. Such as neodymium, Samarium or **magnetite**. Therefore there is zero question that “magnetic pull” really means **hypoxia**, or the **magnetic attraction of oxygen by cation ions**.*

Magnetic attraction is life trying to breathe and sucking air into its lungs. Magnetic repulsion is life exhaling.

And where does graphene come from used in superconductors? The quantum of the very material used in the exoskeletons of Nanites:

*Wikipedia: **Graphene**;*

*“A two-step CVD process is shown to **grow graphene** directly on TiO₂[**Titanium dioxide**] crystals or exfoliated TiO₂ nanosheets without using a metal catalyst. The atomic structure of metal substrates including **ruthenium, iridium, nickel and copper** has been used as substrates for graphene production.”*

100% of the noble metals referenced above come from the one alien seed crystal *Bismuth*. They can grow separately once that crystal has been through separation (“decay”), but in their original form, they are still Bismuth.

SUPERCONDUCTORS 5, COOPER PAIRS

Cooper Pairs are two or more *electrons* (the carriers of Dark Matter electromagnetic energy) that bond with each other, acting as one (like Higgs Bosons do when lowered to a very cold temperature), and suspend the laws of known thermoelectric physics. These are *zero-spin particles* that can take the *same point* in spacetime as each other. When raised to room temperature, Higgs Bosons then separate back apart and become 2 or 2 trillion, depending on how many *Cooper Pairs* decided to “hold hands” within that “one” or singular *zero spin* state. Realize that once temperatures are reduced below where man is intended to survive, the aether ‘particles’ are no-longer supporting

SUPERFLUID HYDRODYNAMICS

animation (we call life). The particles then simply revert back to their neutrino state and place themselves into stasis.

Higgs Bosons, and Cooper Pairs (which are exactly the same things), do likewise, as they are no longer actively supporting **animation** within the hologram.

This is similar to what my contact does when leaving her body to visit council, or to go to another part of the world where there is something she has to tend to like preventing yet another genocide. Something she is doing pretty much every single day now. Her body is literally in suspended animation that needs nothing to prevent its decomposition. Only when she returns does that body now begin to age again, or function within the laws of 3D physics.

**This is not to say that nothing can happen to the Avatar. Recently upon returning from a mission to a live war-front, she had sustained a major wound from what I assume was an explosion that sent a steel rod perhaps the size of rebar (leaving thumb-sized holes in her leg) through her Achilles tendon (the rod was sticking out both sides and had to be removed).*

Cheops SPOKE Pt 1

Since she had materialized there, when she sustained the injury her stasis Avatar back home instantly reflected the same wound. I saw her just 3 days after the attack. The wounds were open and her leg was black around areas. She was walking around again in less than 1 week without crutches, as “she heals 10x as fast as humans do”. Any such injury would have meant at least weeks in a hospital bed and at least a year in recovery.

Now understand that an electron, according to DMS, is “an unpaired *thermal* energy packet” that comes from being “knocked off” of an anion ion. Meaning, this is an anion that has been turned inside-out, so now you can see the actual spark of the electron when it turns into Dark Matter, instead of remaining invisible to the naked eye. As soon as that “electron” is paired back up with another particle, it is immediately once again referred to by science **as an ion**, which is always made up of *two* “Cooper Paired”, *counter-acting wave forces* as explained earlier. Which tells you right there, that if you were to feed ions into a superconductor, they would zip right in, ***just as they do with room temperature crystals where those ions came from in the first place.***

*Which also tells you that the crystal is **already a superconductor** which would technically be called a **superpermitter** in electrostatic ion-speak. Graphene works without oxygen, quartz passes energy*

SUPERFLUID HYDRODYNAMICS

through using it. The big difference is, electricity makes the dipole moment inversion to Dark Matter electrons much easier in a hypoxic state, which is why we keep using graphene and ash to power our Dark Matter devices.

Remember, the “trick” that science uses to get “unpaired electrons” out of a superconductor (turn them into Dark Matter again) is to “harmonize the frequency of the wire to the same resonance of the superconductor”. When you harmonize the frequency of another crystal to the first one, they instantly share 100% of the energy of the two as one. This is called *network covalent bonding*. There is no transfer of energy, it just “is” inside of both, just like the energy is not traveling through a superconductor, it just “is” everywhere inside with no travel-time involved. If the superconductor were the size of the United States, then whatever energy was in California would automatically be in New York at the very same moment.

The energy that passes through a superconductor doesn't travel in electromagnetic form (electricity), it passes through as *ultrasonic, superballistic sound waves*. This is far beyond the limitation known as *the speed of light* that photons are limited to, but not in the same way science believes. It is 3D “matter” while in photon form in the open air (as light), and it is in 3D “matter” form while it is in sonic form in the open air, but before it is released, that energy can travel through other crystals without any sense

Cheops SPOKE Pt 1

of time. It is “open” air or *carbon*-oxygen itself that limits these “speeds” to our senses. While inside the nucleus of the crystal and inside completely shielded pure oxygen, it remains superballistic in scientific terms.

While inside a zero point field, energy is already “everywhere” within all of spacetime, as everything that exists there shares the exact same pin-dot within creation. If you are locked into a particular playing field, meaning you are **observing** that one plane while standing inside a zero point field, then you can then travel mechanically to another destination, but the travel time isn't **recorded** within that field, thus, while you travel, it is *outside of spacetime*. So inside a superconductor, the time that wave takes to go from one end to the other might be “2 seconds”, but the time we will *observe* from this playing field will be zero. When the term **superballistic** was used to explain Cooper Pairs in a superconductor while using graphene, it was only to illustrate that the speed was beyond what could be measured. *It was already there.*

Of course we are far from finished with the subject of zero point fields, but later we will cover the phenomenon of Grebennikov Levitation where he was able to travel at any speed he was willing to brave while he was outside of spacetime (invisible). He claimed this speed to be around 900 miles per hour, so he could instantly travel anywhere to perform tests, etc. What he didn't mention, at least in the reports I accessed, was the fact that when he landed, had he checked his watch, he would have found that zero time had actually passed while he “traveled” to get there. Because

SUPERFLUID HYDRODYNAMICS

that travel would not be recorded within the playing field (referred to as Akashic records).

The *speed of light* was actually established after Einstein's theory had been posited for the speed measured within a "vacuum tube" where all the air had been removed (oxygen), then measured by 10 different scientists who *each registered a different speed*. The 10 speeds were then added together, then divided by 10 to come up with "the speed of light".

Since the beginning, this has been merely a cover story for the agenda of misdirecting mainstream science from discovering the fact that energy isn't limited to speed unless it is supposed to act like it. Since that time, science has established that no vacuum is a void. In fact they can find particles throughout every sub-atomic speck within the tube. So like a light beam that deflects off of a cloud or water, its pathway within the 3rd dimension continuously interferes with its journey, distorting the true speed it would otherwise travel in. Now SM science is finally admitting that fact when it changed this hypothesis to *Variable speed of light*, but apparently no one noticed:

Wikipedia: Variable of light;

"A variable speed of light (VSL) is a feature of a family of hypotheses stating that the speed of light in vacuum, usually denoted by c , may in some way not be constant, e.g. varying in space or time, or depending on frequency."

Cheops SPOKE Pt 1

That last part said it all; it is the frequency, or the state in which energy is expected to travel that dictates the speed. While insulated, there is no speed. While outside of its insulation, each element determines travel time. It has been repeatedly stated by science that neutrinos do not adhere to the speed of light. Naturally, each time this is announced, someone always steps up to “debunk” the findings because that intel is simply not allowed. Again, professional scientists simply do not have the capacity to tell the difference between spoons and oxcarts while using their multibillion dollar equipment such as CERN who has made the same announcement.

That speed is only limited to what had been claimed to be “670,616,629 MPH” while it is being measured in Urth seconds, not cosmeias seconds of which none exist. If you remove the *throwaway numbers* from each set of three groups within this exact claimed original speed, amazingly you get 666 (all numbers after the leading digit within the decimal). This is hardly a coincidence, since the Sumerians who are in charge of all modern science also just so happen to carry the genetic template of the Lulus, the Adam and Eve lineage of Khane which carry this unique DNA signature. They brand their biggest lies back to their chosen people continuously who then relay that to the slaves (you).

SUPERFLUID HYDRODYNAMICS

*To clarify myself a bit when I say that the **Anunnaki Lulu hybrids**, the children of **Adam and Eve** known formally as the **Adam Kadmon** carry **666 DNA**, realize that **genetic Templates** create a specific type of body when translated into material existence as a manifested version of your plasma body, or your “true self”. Within the three billion codes in a human DNA “strand”, there are certain points that determine which provenance you carry forward that is unique to that one species. In the case of the **Lulus**, they carry the **6th Base Tone of the 1st strand**, the **6th Base Tone of the 5th strand** and the **6th Base tone of the 6th strand**, which are different from all other human hybrids.*

*It indicates that these beings come from **Nephilim/Drakonian descent**, that of the giants who were part of the first wave of attacks on the human population 550 million years ago who mixed with their captor’s races. Since then, most of those warriors have defected from the **Luciferian Resistance**, and joined the **Co-Evolution BioRegenesis Treaty of Palaidor** you hear me speak so much of. This allows their Nephilim DNA Template to change into that of an **Angelic Human Krystos** pattern, which will allow them to ascend out of this **Time Matrix**, where they did not originate from. You cannot ascend out of a Time Matrix your Avatar wasn’t originally developed for, unless you change its genetic structure.*

Cheops SPOKE Pt 1

*This special identifier for the Nephilim descent was used in the **Axion Seals** of the **Ra Confederacy**, the guardian arm of the **Emerald Alliance**, to prevent any of these beings from getting into higher dimension again until such time as they have learned how to fully embrace the Law of ONE, because long ago it was these beings who used a loophole in the system to reach the 4th dimension where they started a war and did great damage. So those seals keep them inside of this dimension in quarantine until they fully repair all their genetic strands to reach Angelic Human **disposition, frequency and potential.***

*Thus, to the Luciferian Resistance, these hybrids that are coded to war, have the most advanced, powerful bodies of all the hybrids on Urth, have **clair abilities like that of an Indigo** and are already locked into this dimension, so they are the perfect slaves to use as guards over the humans who will not, **by choice**, be moving forward from this plane.*

*The Anu-Elohim have been behind this plan since the beginning, so you will see their Signet placed before you referred to as the “mark of the beast”. Just be aware, there are **far more** beings on planet today who have this genetic makeup who are under the **BioRegenesis Treaty** than those who have chosen to follow the ways of service to self. Do not make the mistake of placing blame on one another now; you are all in this together to reach higher*

SUPERFLUID HYDRODYNAMICS

than this artificial Chimera Reality plane regardless of which body type you inhabit. The real enemy isn't your fellowman, it is the Elohim being led by remote control by the Bourjha artificial intelligence.

SUPERCONDUCTORS 5, COOPER PAIRS CONT.

At its quantum level, light simply “is”; it doesn't actually travel at all. Only the way the eye *perceives* travel or distance, through artificial mechanical *senses*, is there ever such a thing as animation. This too, is covered in vol 2 DTH, **Spacetime Fabric**.

PLASMA BODY

*It is important for me to note here while on the subject of the science of superconductivity, that the **auric field** (considered your “spirit”) of a biological body I refer to as your plasma body, is a dielectric polar, yet non- magnetic field (light quanta, or photonic, meaning it is pure light which has no electromagnetic spectra that can be measured with modern scientific instruments, but can be photographed as shown through Kirlian spectrography), is actually your “**Cooper Field**” if you will. It is the very same thing as a*

Cheops SPOKE Pt 1

*superconductor that is full of stasis energy, but unless a perfectly **resonant field** is close by (paired), it does not **transfer** energy. Thus, your **physical body** (electrostatic paramagnetic field) and your **plasma body** (stasis or photonic energy) are perfectly and uniquely tuned to each other just like one fingerprint shared by both fields. They can only exchange energy between them as long as their frequencies are exactly the same. This is called **quantum sympathetic harmonic resonance** or simply **quantum resonance** just as unique as your DNA. When your physical body ceases to produce its unique heartbeat (that ultrasonically sets your **resonant frequency field**), then the connection is lost and your plasma field is no longer connected.*

*Thus, your **spirit** literally “leaves” that body, while remaining in the exact same state as before that pairing inside your plasma field. This energy field is eternal and perpetual in both the auric field as well as a superconductor. The only form of energy that “dies” is the electromagnetic (thermal) signature produced by your body which is merely a **temporary vessel**, like a car. And even then, when your body ceases, the thermal energy in each one of your cells simply transfers into many other forms of energy that feed microorganisms, the soil etc. that go on perpetually. No energy has ever been shown to die, only changing in form.*

SUPERCONDUCTORS 5, COOPER PAIRS CONT.

Since the basis of Dark Matter molecular and particle science is reliant upon certain characteristics of electromagnetic-constants that can be explained without the need to reference the aether where the “strong force” electron gets its super strength from, accepted academic science (SMS) must maintain a flatly rigid stance on the explanation of the actions of particles.

In order to accomplish this, Einstein’s *Theory of Relativity* carries a safety net where when quantum particles break those supposed laws, it reverts to *Special Relativity* in order to explain the “spooky action at a distance” being observed which once again then falls back to *Newtonian Law* in order to justify that alteration when Special Relativity fails to explain what just happened. This is exactly like my validating the information in my 21st chapter of my book by directing you to my 6th chapter that says “see chapter 21”. Sumerians wrote *all* the chapters of *the book* of science.

CHAPTER 9

“MFKZT” - THE PHILOSOPHER’S STONE



Laurence Gardner, author of many books including *Genesis of The Grail Kings* and perhaps one of the most interesting researchers of the ancient hidden secrets of the royal elite I have had the pleasure of running across, lays

SUPERFLUID HYDRODYNAMICS

claim to a somewhat dubious provenance; direct descent to the royal bloodline of the *Dragon Kings* of old. He goes into his heritage to extensive degree and holds or held the position of *Chancellor of the Royal Court of the Dragon Sovereignty*.

Much has been written about Gardner since the time he began coming forward with the secrets shared with him by his ancient royal family, and whether he is participating in disturbing ritual ceremonies or not is not what my reference to him is about. What he does on his own time is a choice all sentient beings have a right to choose, all of which carry the automatic response of the aether that keeps the ultimate balance within the cosmeias, from both sides of the path. This is about his knowledge regarding what was called the *Philosopher's Stone* in Hermetic alchemical times as privied to him by virtue of his unique royal heritage.

It was from Gardner that I learned some very interesting details regarding *ormus white gold*, or *monoatomic gold*, that was known in ancient Egypt as “*mfkzt*”. Since they didn't use vowels in their written alphabet, it is unknown today exactly how *mfkzt* was pronounced, but it was revered at the highest level of all Hermetic alchemical pharma in Egypt. I had already been briefed on *ormus* by council at that time, and have learned a great deal more about it since then.

Cheops SPOKE Pt 1

Why I reference Gardner here is mainly due to his mentioning that the ones who “found” the *Kings chamber* (in our current times) in the Great Pyramid, inside the oft-referenced stone “sarcophagus” in the center of the room, contained a white flour-like substance covering the bottom some inches deep. It wasn’t dust, and it wasn’t sand, but a talcum-fine, pure white powder that made no sense to the archeologists, so it was ignored. I am sure simply vacuumed out once restoration began.

Raiders of old had long since removed what else had been inside this single-piece red box now thought to have been a burial container for Khufu. Though the box bore no elaborate inscriptions, decorations or other engravings always found on every sarcophagus of royalty and always found were Pharaohs were actually buried, in the *Valley of the Kings*. None of which were ever found sterile and blank, as was this hollowed out stone box. The significance of this will be revealed more as we go.

MONOATOMIC GOLD

*It is noteworthy to mention here, since Gardner’s extensive seminars on **ormus** being consumed by the members of his royal dynasty leading to their extraordinarily-long lives sparked a mad-dash for everyone to start ingesting monoatomic gold, that I at least briefly address the substance. White powdered gold, which is necessary for the Anunnaki*

SUPERFLUID HYDRODYNAMICS

“gods” of Nibiru to live, and extends the life of their hybrids here on Urth, is poison to the average human. If you just so happen to be of royal descent to the Dragon Kings, then it is pretty much like Gardner describes, extremely healthy for you. If not, then you will suffer a quicker death during your life than you otherwise would have, according to council. She said (paraphrased) to check up on the health of those who began pushing ormus at the time, to see how they are faring today if you would care for some proof. Dragon hybrid bodies are not like those of ordinary humans.

The Egyptians created mfkzt in crucibles by master metallurgists from yellow and white gold (and other materials that also fall within the **noble metals** group) which was then stored in huge vaults in *massive* quantities (hundreds of tons). Once powdered, the talcum-fine flour became in its room-temperature state at 56% of what it weighed prior to purification, and then *less-than zero* weight if elevated slightly in temperature (as it would when presented with any *high level of energy flow*, such as would be present at all times within the Energy Temples while they were operational).

These massive reserves were the collection bins for their Anunnaki “gods” to collect and bring back to their planet known as Nibiru, to be aerosoled into their atmosphere for life-extension reasons. Gold was never carted off to Nibiru in solid bars weighing millions of tons, but in powdered form where it would become less than zero weight once the

Cheops SPOKE Pt 1

time craft went photonic (turned into light) for transdimensional relocation. Not flight. Moving between planets is instant, not a journey unless you wish to float around “nowhere” for a while or engage other time crafts you don’t want just there for whatever reason.

Mfkzt was referred to down through history as the *Philosopher’s Stone*, or the secret of all secrets within alchemy of the Egyptian, Greek and Roman worlds. At its resting-state (below 200C) *mfkzt ormus* particles hold a *zero-spin* (state of *quantum stasis*) atomic signature (also called *triplet spin* as found in *Higgs Bosons* as mentioned), and if placed horizontal to a magnetic field, can levitate or suspend the laws of gravity within that field if their two sonic frequencies are a match. Exactly like, not similar to, a near-absolute-zero superconductor.

Its antigravity affects goes for a single pebble containing magnetite to a rock the size of a mountain, depending on the amount of ormus used to match that size stone (the *signature frequency* of its mass to its contents of magnetite). To find the *signature frequency* of any material thing, you merely raise the amplitude and the modulation on an oscilloscope until the oscillation of two resonant fields match. With a guitar or a piano, you use a tuning fork, or device that sounds out the tone you want to *resonate* with (like the key of C), then tighten the strings until the two *harmonize*. In spectroscopy, this is known as *harmonic resonance*.

SUPERFLUID HYDRODYNAMICS

ORME/ORMUS MONOATOMIC GOLD

Monoatomic gold, produced from gold, silver, copper and other materials within the *noble metals* group when reduced down to a single-atom molecular structure, defies all accepted laws of physics. There are multiple materials that fall into the category of *Orme*, but gold is the most often referenced. If you have never read the history of Orme as written by its patent holder, *David Hudson*, I recommend you do.

Few things are as fascinating as the explanation of what this substance does within highly-controlled laboratory studies. Ormus turned particle science *on its head* and while the data has been vetted by the most sophisticated instruments in assay and particle research *in the world*, everything related to it remains today, decades later, as *fringe science (spooky action at a distance)*, or outright superstition. This is simply because the architecture of how we process the actions of subatomic noble metals would need to be simply thrown out the window if the industry were to embrace these findings. Something Quantum Science is *happy* to do and Standard Model Science refuses as if they are physically blind.

The problem is, ormus (or orme), or *white powder monoatomic gold* acts like a superconductor, but doesn't play by the rules of thermodynamics, so if you were to do a web search on it today, you would run into their "official" soap box where they pronounce their dogmatic decrees on

Cheops SPOKE Pt 1

all matters: Wikipedia. And there you would find nothing. As if the countless aerospace companies now employing monoatomic gold in thousands of ultra-advanced products don't actually exist and the element of ormus is a *fiction*;

*Wikipedia: **Monoatomic gold**:*

“Any suggestions on what should be done with the article Monoatomic gold? Perhaps a scientifically valid article could be written about the topic, but this article references a website that is pure nonsense. --Ed (Edgar181) 13:38, 6 July 2007 (UTC)”

Interesting that it isn't really “a thing”. When you enter “ORME” “SUPERCONDUCTOR” into a web search (the quote marks around “ORME” and “SUPERCONDUCTOR” means the results have to include that specific word in any result, so it isn't going to bring up one without the other), it brings up **53,300 results** such as:

High Field determination of superconducting fluctuations ... - IOPscience

Dynamical Shiba states from precessing magnetic moments in an s ...

(PDF) Superconductivity in Nanoscale Systems - ResearchGate

SUPERFLUID HYDRODYNAMICS

The mechanism of superconductivity at record temperature confirmed ...

Observation of a coherent optical phonon in the iron pnictide ...

Superconductor spintronics: modeling spin and charge accumulation ...

And tens of thousands more citing the application of ORME (the standardized scientific word for monoatomic gold) related to superconductors. If you search other references to this substance under monoatomic gold or ormus, you get 230,000 results for powdered gold “supplements” and equally silly results, but under ORME, you get results for quantum mechanical research papers and PDFs from laboratories *around the world*. If you think ORME isn’t actually being used and applied, do a quick search yourself. There are thousands of corporations working today that would like to differ from Wikipedia’s stance on the matter. But revealing the truth about single-atom noble metals to the public at large doesn’t feed the bull dog as they say, or make those yacht payments.

Indeed, monoatomic gold does seem like pure nonsense to those uneducated in quantum science, since it not only levitates, acts like a superconductor at above-room temperature, but it also *physically disappears*. And I don’t

Cheops SPOKE Pt 1

mean merely disappears like gun powder once it is set to flame, but performs a *vanishing act* for real before reappearing once again in the same place.

During the incredibly extensive and intense years of the highest level of geological assay *ever conducted*, Orme white powder, once reduced to a single-atom state was placed on the scales to read its resulting weight once 100% of all other substances had been removed in a series of elaborate and tediously repeated crucible reductions –*on a continuous, daily basis for years and years in some of the most advanced laboratories in the world-*, then heated to 200C, weighed *less than nothing*. And while the white powder clearly was sitting there in the tray prior to 200C, the most delicate measuring instrument ever created still produced negative-zero results. This was due to the atoms in the powder bonding like *Cooper Pairs* with the tray itself through *network covalent bonding*, and suspending it outside of the forces of gravity. Meaning the weight of the powder and the tray were not “really” there.

The studies were far beyond exhaustive and performed by the very scientist that invented this new breed of atomic assay equipment and fastidiously documented on every possible level, even through *thermogravimetric analysis*, a newer and cutting-edge, sealed-environment diagnostic machine designed for space particle analysis applications. That powder was inside of the 3rd dimension where the laboratory sat, and then it was inside of another dimension the next moment where gravity simply didn't apply and then *came back* to this one once it was ready to have a

SUPERFLUID HYDRODYNAMICS

material signature again. All the while changing its weight from 100% of what it started as, down to lower than zero, back and forth, like it was deciding what material it was going to be today. Not my words, but the words of the now-hundreds of scientists ultimately involved in this discovery along the way. This self-dictated personality or *flavor* as used by particle science is the same exact *flavor* of the enigmatic *Higgs Boson* that earned it the nickname *the god particle*.

This phenomenon is not new. It was proven over *200 years ago* that light particles (what monoatomic gold actually is in *material* form) jump in and out between dimensions at will while not being observed by a sentient being (the scientist). They also casually *traveled through time* in order to fool the observers. You don't need to take my word on this, research it for yourself on over **500 million website results** today under *The Double Slit Experiment*. To someone who still believes after two centuries that there is still such a thing as solid matter in a *superfluid holographic universe*, I suppose this would seem like nonsense.

This dimension-hopping and weight-choosing was verified *consistently* hundreds or thousands of times when the powder was slightly heated to around 175C higher than room temperature, (around 200 Celsius) and then disappeared right before their eyes, only to reappear when it cooled again. But while it was invisible, it gave off no energy signature of any kind; photoradionic, spectrographic, electromagnetic, ionic, scalar or otherwise. It was literally not there, but still there.

Cheops SPOKE Pt 1

Further establishing the fact that what they were seeing was vanishing while still remaining in that same place, or blinking into a different dimension around 200 Celsius, they devised a small arm inside of the machine that was suspending it from outside air interference to swipe across the tray which would wipe all the powder off the scale after it had disappeared. When the temperature cooled down again, the powder appeared exactly as it was before, clearly without any disturbance from the arm. Which leaves no possible other conclusion than the powder was literally skipping through dimensions and *was not there while at that temperature.*

PIXIE DUST

*As merely an aside, interestingly, this white powder gold was reportedly used similar to how we see fairy dust or pixie dust portrayed today in faery tales, passing along its ability to levitate and make them invisible. And I say this is an interesting point, because the royal family tree of the Dragon Kings that Gardner contends he hails from, do indeed have a vast history that is rather tied to this particular faery tale as pointed out in the article **Dragon Blood, Dragon Lineage** by Iona Miller:*

SUPERFLUID HYDRODYNAMICS

*“In Britain, the Tuatha Dé Danann (or Dragon Lords of Anu) were masters of the transcendent Sidhé, classified as "fates" or "fairies". Before settling in Ireland (from about 800 BC), these Black Sea Princes of Scythia (now Ukraine) shared the Dragon nobility of the **early Kings of Egypt**.*

*Like the original dynastic Pharaohs, they traced their descent from the great **Pendragons of Mesopotamia** [Babylon and Sumeria]. The kingly lines of the Irish Bruithnigh and the Picts of Scotland's Caledonia sprang from them. In Wales they founded the Royal House of Gwynedd, while in Cornwall in the southwest of England, they were the sacred gentry known as the Pict-sidhé - from which the term "pixie" is derived.”*

ORME/ORMUS MONOATOMIC GOLD CONT.

Another incredibly fascinating thing about Orme is that it can hold an *unlimited* charge of energy. It can be fed any level of energy into its matter form, held there indefinitely, and only when you place a conductor parallel to it that has been *sonically synchronized* to the spectral frequency of the powder precisely, will that energy then begin coming back out. Understand that all energy conductors or capacitors have a frequency that their material vibrates at. A precise harmonic, sonic oscillation that it maintains perpetually.

Cheops SPOKE Pt 1

Such scalar waves can be measured by a *spectrometer* as employed by *Kirlian spectrography* as well as many other branches of science now dedicated to the research into *plasma fields that surround all things* (up next). Copper or other conductors also continually vibrate (sonic signature), and the thickness of the wire (“mass”) determines what amplitude (magnitude) it reaches. The very word magnitude itself was to describe the power of **magnetite**, representing *the* energy of the 3rd dimension.

Indeed, the very rare stone used in the pyramidion of Amenemhat and Cheops, Black Basalt, just so happens to be one of the also highly-rare *natural sources* of the noble metals that yield *Orme white powder gold*. By now, you may be sensing a pattern here. Hudson never did mention what form his mineral was in to protect his enormous investment in these many years of research, but it should become obvious to you a little later when we begin showing you all the things that noble metals can do, and where they are actually found in certain elements that have to do with the powering of the Energy Temples, exactly what his quarry was made up of.

KIRLIAN SPECTROGRAPHY

Here is a Kirlian spectrograph of a common quartz (*silica*) crystal just as an example, but realize that everything,

SUPERFLUID HYDRODYNAMICS

including spoons and forks, humans and everything else, has a plasma field that we have been able to see through this technology for decades. The reason I use quartz here in the image is just to show that crystals are continuously emitting electrostatic energy at a high rate compared to most all other objects.

Crystals are living things, as shown by science. Placed in water, they pick up growing right where they left off; quartz vibrating at a rate of 20Mhz. Creating or generating energy is what they “live” for, literally. If you paid very close attention to the images I shared with you previously of Black Basalt stone that is entirely living crystal, you noticed that the Basalt tree stump that had been cut perfectly flush 550 million years ago, shows clearly the individual crystals now sticking up higher and lower in places, showing that they are in fact still growing at their own rates, proving they are very much alive. And when measured by a spectrometer or air ion counter, they each emit differing sonic frequencies based on the circumference of each silica-wood fiber shaft. You know this as *piezoelectricity*:

Cheops SPOKE Pt 1



*While we are still a bit away from the section in this report where we get into magnetrons, note how the crystal above is producing more energy from its **sharp points** than it does from its flat, planar surfaces. This is because piezoelectricity is sonic (sound) energy, and the sharp corners it runs into become **sonic resonant chambers**, that amplify its power by **unthinkable** numbers. Resonance chambers and sharp corners have everything to do with ultrasonic waves being used in optics and sonic applications in industry as well as military applications. The facets on this crystal are not there for looks.*

SUPERFLUID HYDRODYNAMICS

In the list of the most *piezoelectric crystals* under that breakdown on Wikipedia, *quartz* is at the very top of the list. The only other substances that are more piezoelectric are composites made from piezoelectric Bismuth crystals that form in man-made settings, making quartz the most *talkative* organic-to-Urth stone in the world.

Also covered on the same page is that a quartz stone under pressure that reduces the stone in size by only *0.1%*, *releases this energy charge*. And remember, these stones don't "die", they are eternal living matter, each generating *measurable* photonic energy.

QUARTZ; NO HALF-LIFE

*Understand that while I speak of **half-life surface exposure dating** of all known material things that make up the world around us, from millionths of seconds to millions of years, the **only one** that does not have a half-life is quartz crystal. This is because that stone is not really a stone, and it is not really material. It is an eternal being. You may not believe that right now, but you can do your own research to see that quartz is not listed in the half-life tables, nor mentioned because it is the spectral, paranormal, paramagnetic, polymorphic material*

Cheops SPOKE Pt 1

*that picks and chooses how it is going to manifest.
Its quantum or smallest form is **Aniline**.*

KIRLIAN SPECTROGRAPHY CONT.

This energy in quartz and other crystals containing quartz that is emitted under pressure is an *ultrasonic wave signature* as covered. Sound waves within human hearing are referred to as sonic or *sound phonons*, and above human hearing are deemed ultrasonic. The *Aswan granite* used in the construction of the Cheops pyramid, as shown by over a dozen extensive assays and hundreds of formal experiments shows that their *general component* is quartz crystal and the sound they emit is the counterpart to light. Light is known as photons and sound is known as phonons. Both are the same frequency and energy, only emitted through two different forms.

The weight of the pyramid is over *6 million tons*, easily causing all but the highest layer of stone to be adequately compressed, turning the entire superstructure into a massive piezoelectric ultrasonic energy generator, ***without any additional mechanisms in place***. Once a super-dense Black Basalt capstone has been added that carries its own eternal electrostatic magnetic field, *100% of every inch* of that monolith underneath its white limestone casing is activated to produce outgoing energy. The capstone, as mentioned, is the literal key-stone that activates the entire mountain to “join hands” in this piezoelectric symbiosis through

SUPERFLUID HYDRODYNAMICS

network covalent bonding. Meaning that all 6 million tons of quartz crystal and 6 million more tons below ground of active paramagnetic limestone, in real scientific terms, becomes one single molecule.

But this isn't the only energy generated by the powerplant, it is but one. Cheops will be dealing with Deuterium atomic energy, Saser piezoelectric sonic energy, Photonic light energy, Cold Fusion, Electrostatic magnetic energy and superballistic monoatomic, zero-point aether energy to turn into a mountain-sized ultrasonic D Wave superconductive powerplant that would make a Dark Matter nuclear reactor look like a hand-crank battery charger.

PHOTORADIONIC ENERGY

“Free” light waves (that are not currently holding a spacetime vector or *signature* within the 3rd dimensional field) are not a readable form of energy by human devices. They can be observed in the form of color, and are known as 100% pure energy and have a *magnitude*, but do not have an electromagnetic signature that Standard Model Science calls “weight”. If those waves move outside of what you are allowed to measure even on a quantum level, then that energy is not an active (visible) part of this one spectrum (dimension). Meaning that *form* of energy is *transdimensional*, and *is the unified field* that powers *all playing fields in all dimensions*.

Cheops SPOKE Pt 1

The core of every atom is made up of *only* light/sound waves. Not “solid” particles. When they are in “matter” form (like your desk or your body), only then can they be “measured” through their magnetic attraction and repulsion and are called fermions or *atomic matter*. Fermions are *firm-ions*, or energetic things that seem tangible. There has never been a single speck of “matter” ever found at the quantum level of any material thing within our reality field. Once again, the real science of this is explained quantitatively in the human handbook, DTH vols 1 and 2.

Such “free” light waves are known as *photons*. Firm-ions make up atoms that then make up molecules, and free ions make up photons. Hence photons are not currently holding a material “matter form” outside of light that does not cast a shadow. Because they are visible in this instance, and because they are audible when in sonic form, I refer to them as “material”, only to distinguish the difference between 3D energy and neutrino energy that is entirely aetheric. This is factually what NASA calls *plasma energy* when observed in “space”. Photonic energy is the foundation of where all *electricity* comes from after it enters Urth atmosphere in the form of neutrinos and strikes a proton, creating an ion. But from there, it manifests in multiple different forms of energy we simply coin electricity in general terms as we have clearly seen so far. There are more forms to cover.

SUPERFLUID HYDRODYNAMICS

Among the most devastating of all energies ever used against Tara and the human evolution has been something called photoradionic weapons briefly touched on previously. It is a process of inverting the photon Light Matter ion state into a Dark Matter state where the Radon wave (the red wave mentioned earlier) now travels through the open air in an ultrasonic oscillation, exposing all the matter between it and its target to fusion decay, where molecular particles literally feed the propagation of its path, or “demolecularize” firm-ions. We would call this being vaporized, since it would leave nothing but zero oxygen carbon (graphite) behind. This is how Atlantis was sent to the bottom of the Atlantic Ocean in very ancient times. Another word for it is *antimatter beam*.

The photoradionic wave is sent out in sound pulsations known as Saser lasers covered next. Sasers can send out antimatter beams, or they can send out matter beams that are merely Light Matter propelled by sound which cause no decay or pose no threat to the human DNA. Since all forms of usable energy within the 3rd dimension come from ions, a photoradionic weapon uses the open-air photon inverted into a Radon wave powered by negative ions. **Photo-Rad-ion.**

SASER ULTRASONIC RESONANCE LEVITATION

Cheops SPOKE Pt 1

Sasers are laser beams that are ultrasonically generated; energy waves that are generated by sound that can be within or above the visible human spectrum, just as their sound is outside the audible human spectrum. This energy is just as real as the current flowing through your toaster or radio waves in your air and science has finally moved into the arena they term the *acoustic laser*, or *saser*.

Pay careful attention to what Sasers do;

*“They produce a **coherent** and controllable shining beam of laser light in which **all the photons have the same frequency and rate of oscillation.**”*

Realize that the word *coherent* used above is a specific scientific term, not to be confused with someone just coming out of a daze. This means that the electrons inside the light beam now act like *Cooper Pairs*, holding hands as a single entity, and the word coherent means they now *independently* from SMS, *think*, and *act* like one. This is the quantum explanation of the *god particle Higgs Boson* as you recall. Or what makes the god particle so different than the energy we observe in our 3D world. Incredibly, by reaching the exact same frequency as a mass containing a magnetic field, they generate a Meissner Effect, just like superconductors, suspending the gravitational field within their *torus*.

Realize that a laser is sending out Dark Matter electrons in that obvious light beam that does not place all the photons

SUPERFLUID HYDRODYNAMICS

in the same frequency and rate of oscillation, but rather in electron form which is frenetic and not balanced in any way. This is why a Saser and a laser are two different things, even though they seem like the same thing. But when Saser energy is directed, it is invisible unless it is using visible light waves as the carrier. Sasers can broadcast radon waves (radiation) along with the sound if weaponized. The Energy Temples use Saser beams without that component.

When pulsed, Saser beams function on the order of scalar mapping waves as shown here where they are used to generate a multi-level Meissner Field of zero gravity:

Cheops SPOKE Pt 1

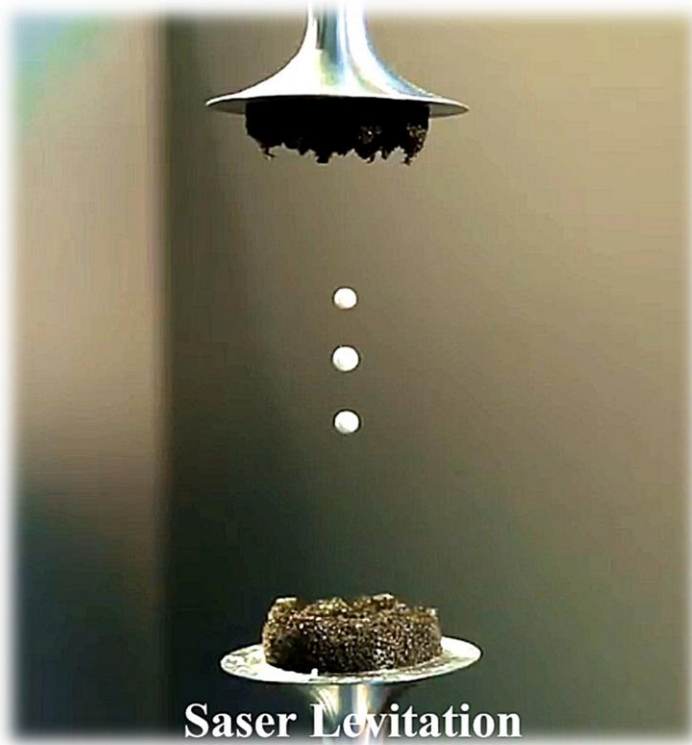

Notice in the image above, the balls suspended are equidistance from each other, precisely holding each one in place inside *multiple zero point fields*. What you are seeing here is a quantum-multiplication of *repeated Meissner Fields* held together simply because the one Meissner Field is being pulsated through a square wave that isolates differing levels of “space” (this is the function of a Mandala from ancient times), which is being handled by *gauge bosons* within the scalar field it is projecting. So Saser levitation is different in that it can operate at different levels within the same given space. This would come in handy if you were generating energy inside let’s say, a pyramid that was being used like a multi-staged magnetron

SUPERFLUID HYDRODYNAMICS

or more precisely, more than one magnetron and more than one *synchrotron* where you want to make multiple Meissner Fields to create multiple zero-points which stage more than one distinct frequency wave to accelerate from different trigger points.

TORUS FIELD

In electrical science, a *torus field* is generated by a donut-shaped ring where the flow of mechanically-generated electromagnetic energy passing through the ring is bound within the loop, as there is no place for the energy to travel through to reach outside of the ferromagnetic metal conductor, so it generates a sphere of energy around the device. Free, unpaired electrons continually circulate this field, just like they do within an atom. What meets the human eye is merely a small part of the electrical fury encircling the ring continuously in an apple-shaped toroidal sphere as displayed vividly in a Tesla coil:

Cheops SPOKE Pt 1

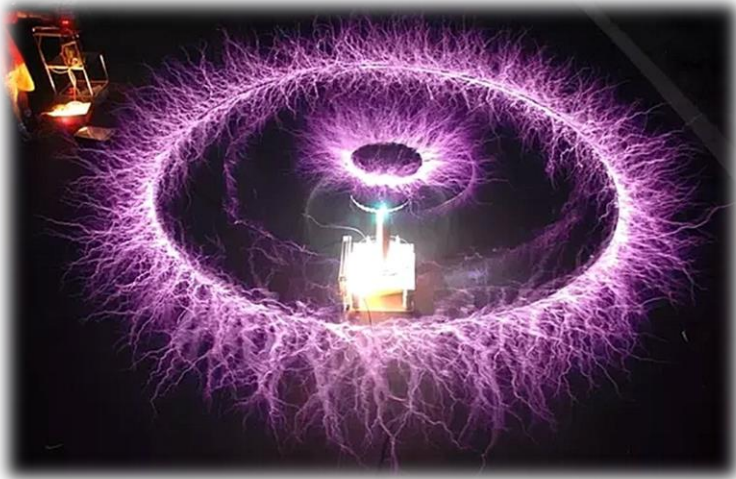

In the mechanically-generated use of inverted Dark Matter energy, until a connection is made from somewhere on that ring and its opposite side, the electrons continue to only flow around this field. Once a connection is made, then the energy flows in and out of those two points, just like a battery. However, this energy can still connect with a conductor through direct arc-jumping. It just isn't insulated when it does this which can be dangerous or even fatal, which is why we use energy inside of insulation (rubber coating around copper wire) to keep the power "safe" for general use.

Still, even when electricity is now flowing out of two connection points, that donut ring continues to produce this torus field, similar to the energy field that surrounds an electric motor or generator. "Electricity" from such a source carries a thermal signature, which means it is always

SUPERFLUID HYDRODYNAMICS

cooking as it travels. When pulsed out through the air, such as from a microwave oven or cell tower, then it cooks everything in that path, even though you don't feel the heat, because it is in a sonic frequency range that goes to your DNA core rather than to your surface body called a *valance*.

Your DNA is your nucleus in terms of how crystals store energy and the inside core is where microwaves cook from; the zero point. You can pull a bowl of mashed potatoes out of a microwave where the outside is cold or even frozen, while the inside is hot enough to burn your tongue.

Torus fields are generated by both Dark Matter electron motors and generators, and by Light Matter static energy generators such as crystals. All things have a torus field of either one or the other. By now you know that Dark Matter torus fields are Radon radiation fields.

RADIATION FATALITY PANDEMIC

Take a look at the dates when cancer, heart disease and diabetes became an epidemic; now take a look at the dates when man first began using Dark Matter electricity. Much of this use involved "shielded" wires coated in flimsy rubber coating or outright plastic alone. Or not shielded at all, such as your absolutely bare power lines suspended

Cheops SPOKE Pt 1

directly over your heads. These are coincidentally the same dates:

Prior to 1900, the common man and woman smoked or used tobacco which wouldn't be weaponized by more than 7000 chemicals and 599 deadly poisons by big tobacco until decades later in the early to mid-1900s. Even so, global cancer records show that mortality rates ages 15 and over remained constant at 0.23% until 1893 when suddenly, cancer in all forms (labeled "diseases") made a sharp, unexpected leap. Ref: MORTALITY RATES FROM CANCER AND TUBERCULOSIS BY J. L. HAYBITTLE

On May 1, 1893, President Grover Cleveland pushed a button and 100,000 incandescent lamps suddenly jumped to life, illuminating the City of Light at the World's Fair in Chicago, Ill. Three-quarters of a million people attended the event which kicked off a global race to light the world:



SUPERFLUID HYDRODYNAMICS

***By 1901**, a handful of X Ray machines had made their way into hospitals in larger cities deemed safe for medical use.*

***By 1902**, the first X Ray lab technician exposed to radiation developed skin cancer.*

***In 1903** Thomas Edison dropped all X Ray research after learning his technicians were dying. X Ray machines surged in sales nonetheless.*

***By 1950**, death rates from cancer had risen from 0.23% to 19.3%, or an **8400% increase**. This was not merely a “lung cancer epidemic” caused by tobacco: it was also a general cancer pandemic in the form of Leukemia to bladder, breast, colorectal, kidney, lymphoma, and prostate cancers across the board.*

***By 2018** 75% of deaths are from cancer, diabetes and heart disease, not old age. That’s 3 out of 4 deaths that will end in days, weeks, months or years of agony that will wipe out 100% of the nest egg you had worked for all your life for your golden years that will be absorbed by the medical industrial complex faster than you will be able to ask what happened.*

Cheops SPOKE Pt 1

So what did happen? Just 14% of adults in the US smoke today as compared to nearly 50% in 1950, yet deaths from cancers and similar, related diseases have quadrupled. This is an **8000% change** that is exactly proportionate in spread in the direction of death, just since 1950 alone, and an unimaginable **32,600% increase** since 1893 caused by modern man. Not by ebola, West Nile virus or the bubonic plague:



While diabetes and heart disease are not listed as “cancer”, they are still considered very much the same things in real terms. Cancer is caused by many things, but irradiating the life force out of all your crops grown under your powerlines, irradiating your foods in stores for “purification” and irradiating your genetic template is the main cause of death in modern times. In addition to that, you also place those already barely-surviving foods into microwave ovens which render them as nutritional as cardboard or notebook paper.

SUPERFLUID HYDRODYNAMICS

When you are three feet away from a microwave, you are exposed to up to 25mG of electromagnetic, black body radiation, which means that your body begins the process of dying at an exponential rate that is **500 times** the “safe” levels allowed by the EPA.

And just to add insult to injury, when you do get cancer, your doctor prescribes “radiation therapy” to treat it, when they know that a \$2 box of baking soda would perform 1000x better. Lobbyists don’t pay them to sell baking soda, but the medical machine pays them giant salaries for prescribing radiation that keeps them all in business. It’s all right there in the medical industrial complex’s *Hypocritical Oath* written by Hermes, rewritten later by Hippocrates, father and student of Occult Dark Matter Alchemy and father of modern medical science. See **Hippocratic Genocide**, vol 2 of DTH for more.

Radiation comes from electromagnetic energy fields, not just X Ray machines. They surround every electronic appliance, component and device in use today. Instead of calling all your diseases different names, why not call them what they are; death by radiation.

Samuel Milham MD, MPH, Medical epidemiologist:

Cheops SPOKE Pt 1

*“Very recently, new research is suggesting that **nearly all the human plagues** which emerged in the twentieth century, like common acute lymphoblastic leukemia in children, female breast cancer, malignant melanoma and asthma, **can be tied to some facet of our use of electricity**. There is an urgent need for governments and individuals to take steps to minimize community and personal EMF exposures.”*

Next we look at how applied magnetic fields cause certain materials that are strictly not electromagnetic conductors of radiation can actually suspend the laws of gravity.

CHAPTER 10

SUPERFLUID HYDRODYNAMICS

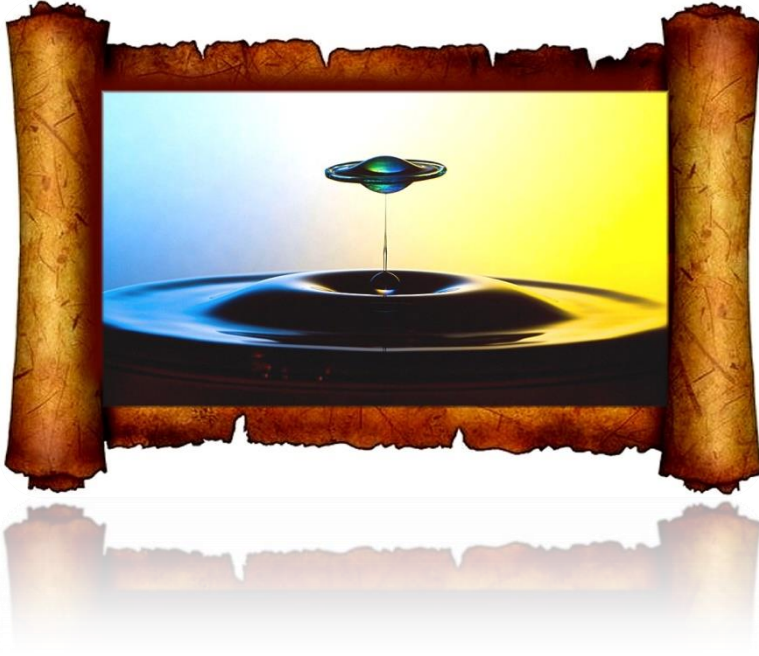

Air is water, just thinner. The way it moves is exactly like its denser counterpart of H_2O water. When water moves through a funnel, it increases in velocity and intensity, collating together like *Cooper Pairs* forming a single unit as it were, where it travels without friction or turbulence in a spiral.

As long as there is no break or variance in the surface of that funnel after its transition down to that concentrated form, it now travels as that one unit rather than millions of

Cheops SPOKE Pt 1

droplets. The result is a “shaft” of water coming out of the end of a garden hose for instance. In atmospheric applications, this superfluid melding of the water (air) particles produces what is known of as *laminar flow* where the air or water forms an insulating *pocket* between the “Cooper Pairs” as it were (the water particles now “holding hands”), and the surface of the object it is moving past.

All flying vehicles rely on the lift generated by laminar flow, as it is what *lifts* them into the sky, not their wings “cutting” through the air. The leading edge of airplane wings are shaped in such a way as to curl or direct the air into this non-turbulent, spiraling, shielded form, which then generates the unique characteristic of defying gravity. Just like neodymium magnets facing a superconductor, planes are not *flying*, they are *levitating*.

In many of my inventions in the past, I worked with laminar flow because my primary invention that sparked an industry relied on the creation of kinetic energy and the movement of water and air without turbulence that produced the desired effect far away from the source without disturbing the air around its destination. The entire foundation of the main invention was based on completely free energy that powered the device and it didn't have a single power cord going in or out of it, so superfluid hydrodynamics you can say is my area of expertise. No one that saw the product work could believe it didn't use batteries or electricity until they were allowed to look inside and see for themselves, and always with their mouths open in disbelief. I don't mean that symbolically, I mean

SUPERFLUID HYDRODYNAMICS

many hundreds of times I watched their mouths drop open as they peaked in.

Those inventions, just like most of the information in this disclosure series, came from my higher self. Revealed to me in visions (or downloads), just as all the names you know of in particle science admit where their inventions came from; during twilight sleep. Some of the disclosures in this handbook series did come from my contact however, just to be clear. I mention this to make it transparent that I didn't simply deduce all this information on my own, but am more of a messenger than anything else. However, this is the area I know from my own scientific research that spanned two decades.

In superfluid hydrodynamics, laminar flow, or the act of becoming "one" body rather than millions of different drops of water, allows it to take on the same general nature seen in quantum locking. When you create a laminar flow "shaft", you can shoot a laser beam down the shaft, and it will follow wherever the water goes, literally bending the light (and as in quantum locking where the *magnetic force* is suspended in animation, it is controlled entirely by the superconductor). What this says, is that the flow of the particles while in laminar form, are creating their own "world" where normal physics do not apply. Not sort-of-like, but exactly like Cooper Pairs holding hands.

Cheops SPOKE Pt 1

Water and air, when guided into superfluid shape, create a torus field around the particles that not only hold those particles together as a single flow, but also creates a shield that light then refracts through, staying inside that invisible 'shell' until such time as enough dielectric carbon (electrons pointing in random directions) particles in the air thin down that stream, or striking a surface like the ground or regular water, which breaks their Cooper Pairing (because they have now gone to ground, neutralizing their Meissner state). Though the water does still move back downward through gravitational push because the sheer amount of energy at that weak point isn't enough to fully suspend that field. While the water particles are paired, that water or air travels free from the same turbulence that electricity is free from while inside the superconductor's Meissner Field:

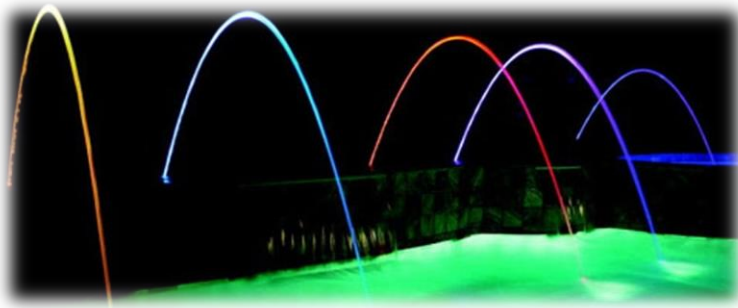

In the same way that water particles become one when directed through a smooth, non-turbulent pattern, ions *combine their energy together* instead of robbing each other, as electrons do traveling down the copper inside your lamp cord. This combining of energies causes them to go

SUPERFLUID HYDRODYNAMICS

into a laminar, *superfluid* state as seen in the example of hydrodynamics above which accelerates their travel to reach artificially-increased speed. Through the same secondary emissions generated by electrons and ions, their energies multiply, propelling them with much greater velocity toward their destination. A solid shaft of water places all the water particles at their furthest possible distance, whereas turbulent water delivers maybe a few drops that far if any at all, the rest falling far short due to atmospheric wind perturbation, directly equated to thermal friction.

In short, water and air act like electricity, because like Black Basalt, they are both paramagnetic. When the initial release of water or air begins, it generates an electrostatic magnetic field which turns the crystals in the atomic crystal lattice of water/air in the direction of the applied field which causes a chain reaction of secondary emissions that combine the water's energy with the anion ions in the air, creating both a sort of Meissner Field, as well as Cooper Pairing. As you will see, these atomic crystals in the air when presented with the right combination of other materials do indeed create 100% zero-point Meissner Fields, superconductivity and superballistic energy flow.

LEVIMOON® LEVITATION

Recently, floating balls, floating speakers, and even floating moons have entered the mainstream market. Of

Cheops SPOKE Pt 1

course, they aren't telling you how this is done, but you too can have your own Levimoon® for \$359, hovering in the air over your desk. And while this is actually Urth-shattering news, somehow it remains just a gadget for curiosities' sake, naturally for sale for magic money. And you are supposed to believe that the little "thing" that is inside that base and the minerals that are inside this moon cannot be scaled up any higher than just this size so you could use it for something practical in your life, such as for building your own stone home elevated away from seismic and other natural forces that would never fall apart with a half-life of a million or more years:



SUPERFLUID HYDRODYNAMICS

While this technology could change the world in a heartbeat, instead it is rolled out as a stupid pet trick. The base sends out a scalar Saser beam wave that quantum locks with the magnetized “moon”, which is tuned to its sympathetic harmonic resonance field, creating a *Meissner Field*. This generates the zero-point torus field where gravity is nullified, exactly like a superconductor and a neodymium magnet, graphite, graphene or even Basalt that are rich in magnetite which all have a powerful paramagnetic signature.

While the gadgets for your desk might weigh a few ounces, this could be your car hovering within this field, or your house. Not that you already understand the benefits of a house that levitates, but I can tell you right now that the houses that the Sumerians live in sure do. Because they are also time crafts that allow them to translocate to any point around Urth in an instant and never bother to touch down on the ground because the energy to keep them perfectly level, unaffected by earthquakes or any other material force is perpetual and completely without cost. And the Meissner Field also is 100% water tight, so even while they are parked at the ocean floor, they are still not resting on soil or dealing with ocean currents. On top of this, as long as they are inside that field, their bodies *do not age* in any way as I understand the zero-point.

AEROPLANE LEVITATION

Cheops SPOKE Pt 1

As mentioned, aeroplanes don't fly, they levitate.

While that might sound insane right now to you, the science is still there to prove this claim. There is a reason why planes don't flap their wings like birds and other flying creatures do. It is because they are using sonic propulsion to propel the craft down the runway that creates an applied magnetic field. This causes all the ions within their aluminum bodies to align together, combining the protons (cation ions) of the aluminum to create secondary emissions from the anion ions in the air, generating a Meissner Field around the plane to create zero gravity which causes its initial take off.

Once that plane has reached this suspension field, its velocity now creates laminar air flow in a precisely-tuned sonic resonance field around the curve of its wings which then creates phonons. The sound literally generates a temporary Meissner Field around their structure that is just enough to suspend the push of gravity that enables the plane to continue creating the zero-point, antigravity field while the turbines utilize aetheric photonic energy through ultrasonic propulsion to propagate forward movement. Do not mistake this for "flight".

With only a quick web search, you will see that many people have taken videos and shared them online of passenger planes that have stopped and are hovering as if frozen exactly in that one spot in the sky. On **Jan.22, 2009**,

SUPERFLUID HYDRODYNAMICS

U.S. Airways flight 307 from Frankfurt Germany to Charlotte, N.C. via the skies over Greenland, came to a dead stop for 13 minutes hovering at their previous altitude. This was not just reported by the passengers, but recorded as well. You will find this under a search *Airplane Freezes In Mid Air*, among other titles. I could post many other videos taken live by everyday people for reference, but you can also see for yourself this is not an isolated case by any means. It just doesn't make the news, because you don't need to know that metal planes are zero-point levitation crafts.

Right away anyone not knowing the science of how a "low pressure field" is created that causes air to *lift* planes up into the sky, rather than to simply glide through temporarily like a wooden or paper airplane, is going to recoil at this notion like I just stated that the sky is purple. What I am about to explain now isn't about gliders such as the Wright Brother's first flying machine that just so happened to be light enough to sustain flight for a short distance while they peddled like hell on its back.

Such crafts are known as **airplanes**, not aeroplanes. An aeroplane is a different breed of cat entirely. Airplanes use lift mechanics to fly, *aero* planes, like the *aero* space industry, uses levitation. I am talking about metal planes that weigh as much as six hundred tons (and more). Let's all read that again shall we? A **single plane** weighing **six hundred tons**, the same weight as *fifteen semi trucks* pulling fully laden trailers or the same weight as **four hundred automobiles**.

Cheops SPOKE Pt 1

Flying.

In the *air*.

On *two* wings.

Do you honestly think they are floating up there on nothing but air current like birds that weigh little more than feathers? Really?

And do you know how strong the wings would have to be in order to carry 600 tons outstretched 123 feet to each side on such a craft? I'm glad you asked. Here is the **Cormach 230000E9** boom lift crane that makes its claims well known:

SUPERFLUID HYDRODYNAMICS

Largest, Strongest, Longest Knuckleboom in the World



Now imagine instead of using flimsy aluminum for the wings of a 747 passenger jet, you used these cranes to hold up the weight of that craft instead, which would be many times stronger. This crane (not the truck) weighs just over 43,000 lbs and its reach is 150 feet. It can lift 93,308 lbs (with zero harmonic distortion such as aeroplane wings would encounter every second of every flight, increasing the sheer effect of the load to its construction by as much or more than the original load).

A “lightweight” Boeing 747-400 passenger jet weighs 450 tons. All the weight of the plane, the “fuel” and passengers, with their luggage, rests entirely on the wings alone (if it were actually designed to glide). Which means each wing would have to support $\frac{1}{2}$ of all that weight apiece. Plus, it would also need to carry far more than that weight due to uplifts and downdrafts, not to mention exiting “air pockets” which do not actually exist.

Cheops SPOKE Pt 1

All of Urth atmosphere is filled with “air”; which is either positively charged or negatively charged ions suspended by hydrogen and oxygen. “Air pockets” are areas where the ions are depleted of the energy the craft uses to power its levitation as well as its forward momentum. This is why a plane drops straight down (does not nosedive, but simply falls) like a brick when it hits such pockets after travelling through a long enough stretch of depleted anion ions. (You didn’t really think there was no air in the air, right?)

Now we do the math.

The 747 wings are made out of 7075 aircraft aluminum, which was the strongest version of this very light metal available at the time it was made. The Cormach crane is made out of HSLA steel, which stands for high strength low alloy. This is far stronger than even *carbon steel* and is made of vanadium, chromium, molybdenum and titanium among other alloys. While it is heavier, it is *far stronger* than aircraft aluminum in shear strength, tensile strength and fail strength. Even though HSLA steel is so much stronger than 7075, it would still take **46 ½ of these cranes**

SUPERFLUID HYDRODYNAMICS

to hold up 450 tons. Yet you are supposed to believe that just 2 aluminum wings actually do all this work:



Now let's say that we used Cormach supercranes to replace the flimsy wings such crafts use in order to have some frame of reference as to just how much wing-to-load aeroplanes are supposedly using in order to "fly". For this comparison we'll act like the supercranes will all be covered over together with a sheet of aluminum after they're bolted on in order to make them aerodynamic for flight.

The Cormach supercrane is $8\frac{1}{2}$ feet wide, or, roughly 100 inches. We will need a total of *193 feet of continuous crane* running down each side of the craft just to bolt these on. Since the 747-400 is only a total of 232 feet long, that would give you just enough room for the tail wings alone left over. In other words, it would be *one continuous wing*.

Cheops SPOKE Pt 1

Or, roughly *four times* as much wing as the 747 is actually fitted with. And we are talking about *titanium molybdenum cranes* rather than aluminum, which is like comparing a hammer to a noodle in strength:



And while the aerodynamics of the wings fitted to these monsters is indeed engineered for strength to resist high speed oncoming wind, there is little structural strength at all to support any vertical weight. And covering only 1/4th or less than its full length, there is *no material known to humankind* that wouldn't snap right off the second the wings were asked to lift that craft into the sky. That material *does not exist*, even if you were able to connect it to the body of the jet with a few bolts that wouldn't just snap right off, such as the case with wings that are secondarily fastened and not unibody-molded to the craft itself. Yet we are supposed to believe that the paper-thin

SUPERFLUID HYDRODYNAMICS

wings on this colossus below, the Airbus A380 weighing in at *575 tons* are supposed to carry that weight. Only in the *dreams* people are willing to believe who know absolutely nothing about physics:



To make one of these behemoths leave the ground and not slam back to Urth 2 seconds later, they will use *ultrasonic levitation*, *superconductivity* and *pulsed magnetic zero-point Meissner fields*. And you can believe me right now, they do not run on jet fuel. Jet fuel only powers the starting of the turbine engines that that will cut off from combustion and switch to aether as soon as they reach a speed that begins the flow of electrostatic electricity (a few seconds).

Passenger jets have never run on fuel since the **day** they were introduced in 1952. Don't take my word for it, go online and watch the first video ever taken of a passenger

Cheops SPOKE Pt 1

jet and tell me if you see any flames or any heat waves of any kind while it takes off. Now go take a look at a fighter plane that actually does use fuel and you tell me the difference.

While you're at it, take a look at how long it takes for them to pump *one fifth of a million liters* of fuel into a 747 between flights. Unless the wings opened up from end to end across their entire tops and they free-fall dumped fuel into them using a firefighter supertanker above, it certainly is going to take more than the two minutes they actually use (which we have on time-stamped video). It takes longer than that to gas up a passenger car at the fuel pump which is **2100x less fuel**. If they were using a hose and pump head that transferred **ten times** as much fuel as a filling pump, it would still take **17 ½ hours**, showing you just how stupid they think humans actually are. Passenger jet travel has been virtually without fuel costs since day one.

Now let's take a look at what a "low pressure area" is that science claims causes virtual ocean liners to lift off into the clear blue sky:

SUPERFLUID HYDRODYNAMICS

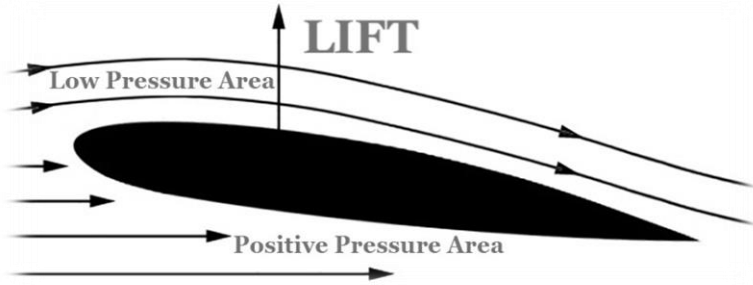

As you can deduce from the illustration above, the wing of the plane isn't cutting air and sitting on top of it somehow. It is generating a temporary "low pressure area" above it as it moves. Anyone would immediately assume that this air foil that is causing this portion of the air to be somehow less pressurized than the air below the wing is generated by the high speed draft from air displacement, causing the wind to blow upward off the wing, thus sucking the plane upward into this vacuum.

This is not what is happening, but it certainly does have something to do with wind. And more so, it has to do with a vortex field being created by the shape of the wing that then churns the air like a cyclone which creates a zero-point anti-gravitational field at the very center of that cyclone. This is also called a *hydrofoil* that lifts giant watercraft up to the top of water and allows them to "skim" at much greater ease:

Cheops SPOKE Pt 1



That there is a center-point to cyclones and tornados where gravity is suspended isn't news. People and houses have been lifted into the eye of these storms since time began. In that eye, there is zero wind and zero danger as reported by the few lucky people who have experienced it first hand and lived to tell about it. But immediately surrounding that vortex, there are boards flying at hundreds of miles per hour, and all sorts of things zipping past that can maim or kill in the blink of an eye. This boy made headlines around the world on 4/16/2016 in Gansu China when he was gently lifted up and suspended in a dust devil, suffering only minor injuries when the suspension field subsided:

SUPERFLUID HYDRODYNAMICS



This same zero-point suspension zone that can be generated by winds striking the same area coming in from 2 or more directions, and producing this phenomenon can also be mechanically generated. It isn't the wind that is suspending this boy, any more than it is wind that is suspending an aeroplane.

The ultrasonic resonance field generated at the point of impact where the winds all meet sonically generates a Meissner Field as seen in ultrasonic levitations in laboratories. In this case, the sonic resonance "chamber" is created inside the air gust's contact point in a vertical shaft. The sound chamber created by airplane wings creates the same thing, only horizontally. And the reason why the plane is being lifted upward is because the suspension field is reacting off of the static electricity coming to the frame and coating of the wing and the plane itself.

Cheops SPOKE Pt 1

The hollow of the wing is the *resonance chamber* and the metal sheathing and frame is made out of what is called “aircraft aluminum” today. Something that German scientists “developed” for their airplanes in WW1 then called *duralumin*. You know, the same Germans that were deeply into ancient Occult (hidden) technologies for decades, culminating to their production of magnetic-pulse (ultrasonic pulse) levitation space crafts the Nazis referred to as *Haunebu* more commonly referred to today as Foo Fighters, a term that is comical by design to make you dismiss them as if they never existed.

Take a look at the reports from many first-hand accounts yourself about the Haunebu crafts before you decide that they they’re a joke. Admiral Byrd’s men witnessed the onslaught from these crafts that decimated his team of 13 top level war ships, 23 fighter jets and 4700 men in a matter of minutes while serving his mission to Antarctica (where the Germans have been shown to have relocated to before the end of WW2) during *Operation Highjump*. Its all written right there if you have the time to spare to understand what really happened. Here is a tiny excerpt:

*Fighter Pilot John Sayerson, February 26, 1947,
Operation Highjump:*

“The things popped out of the water like they were being chased by the devil and flew at such high speeds between the masts that the antennae between the wind eddy ripped. Some airplanes that were able to get into the air off the Casablanca were hit moments later by unfamiliar blasts that came from the flying saucers and crashed next to the ships. I

SUPERFLUID HYDRODYNAMICS

was on deck the Casablanca at the time and was totally taken aback. These things did not make a single sound as they flew between our ships and spit deadly fire. Suddenly, the torpedo boat destroyer Maddock, which was about 10 cable lengths (less than 2 miles) away from us, went up in flames and began to sink. Rescue boats from other ships were sent despite the danger. The nightmare lasted about 20 minutes. When the flying saucers dove again under the water we began to count our losses. They were appalling.”

The new metal that allowed planes to massively exceed the weight of feathers to fly through the sky as otherwise propelled gliders was handed to them through the *Thule Society*, the official military Occult arm of the Nazi Third Reich by a pre-Atlantean breakaway underground civilization known as the *Hyperboreans*. Aluminum isn't really what you think it is, and aircraft aluminum isn't either. These are very special, intensely-high piezoelectric, *paramagnetic* “noble metals” as derived from *Bismuth*. The flimsy aluminum you are given for everyday use in your kitchen is merely one of many extracts of the alien crystal:

Cheops SPOKE Pt 1



Raw Magnesium extracted from Bismuth:

SUPERFLUID HYDRODYNAMICS



Aluminum foil can be retrieved right out of a 400 degree oven by hand. Why is that when a smelted, Redoxed *ferromagnetic* iron skillet (which is an *insulation-free* conductor of electromagnetic energy) would burn you to the emergency room? It is such anomalies that we now take for granted in the 21st century as just how things work. But things work the way they do, only as those scientists who hold the secrets allow you to use them, not how you are not supposed to use them.

Metal aluminum is almost instantly cold to the touch after being subjected to intense heat because it is the metallic form of graphite which is a thermal conductor due to its near-total lack of oxygen. Which allows it to absorb the heat generated by the extremely radical thermal radiation generated within a torus field by electrons filled with Dark Matter electricity transferring into artificial metals inside the turbine of a jet engine for instance.

Cheops SPOKE Pt 1

While mere aluminum is very soft and of little value in a mechanical device, Magnesium isn't. Aircraft (**A**ircraft) aluminum (literally named specifically after *aeronautic applications*) is aluminum mixed with even more Dark Matter unpaired electron-filled Magnesium to create a *super hard, super piezoelectric, super thermal conductive* "metal" that received its name from the fact **the first time the world had ever seen or even heard of this magical material** was from *fighter jets coming out of Germany*. Until then, only featherweight "planes" could possibly fly in the air instead of dropping like bombs. Hence the word *aircraft* was born because *spacecraft* was already taken.

The very first planes made of duralumin were called Junkers reported by the US military as being made of corrugated iron following WW1, but this was merely a cover story for the advent of this new, space-age material that would take decades before it would even be revealed to the civilian public. As long as the public believed that "iron planes" could fly, the stage was set to foist into the collective psyche that combustion flight was possible as long as you had powerful enough thrust, regardless of the minerals involved.

Finally the very first commercial jet airliner was created from duralumin for passenger flight in 1949 called the *de Havilland Comet*. Taken from a video reel of those earliest days of levitation, here is an actual capture of the engines of that craft while just lifting off and folding its wheels up. Even though it was a dark, cold day, there is absolutely no

SUPERFLUID HYDRODYNAMICS

trace of heat or flame visible from its turbines at any point from taxiing, acceleration or lift off of any kind:



This was due simply to the fact that it was using ultrasonic magnetic propulsion from its very inception. Any heat signature of any kind would have been enough to at least illuminate the inside of its turbine thrusters, yet there they are; *pitch black*.

BISMUTH THE ALIEN CRYSTAL

When it comes to Dark Matter, *every single material* used in modern times to conduct the energy that nanites feed off of, **all** come from *Bismuth*. You name it; it comes from that one, single, *mother* alien crystal. Copper, silver, iron, nickel, platinum, gold, tin, aluminum and Magnesium along with every other “mineral” used as a “conductor” of Dark matter.

Cheops SPOKE Pt 1

This single crystal is responsible for thousands of minerals mined today that have broken off and now grow as independent “stones” producing chemical “oxides” that bring havoc, misery and death to mankind. Until the “Mother of Radon” (RA) was seeded to Urth’s plane, Light Matter energy was the only energy easily produced. Not only is *every single noble metal* from this one source, but *every single one of the 9 deadliest minerals on Urth* are **decay residues of Bismuth:**

- **Chalcanthite** (Copper)
- **Stibnite** (Antimony)
- **Asbestos** (Magnesium Talc)
- **Arsenopyrite** (Iron)
- **Cinnabar** (Mercury)
- **Galena** (Lead)
- **Hutchinsonite** (Arsenic)
- **Orpiment** (Arsenic)
- **Tobernite** (Uranium).

As you can see, even the single most valuable mineral on the planet, Uranium, which is highly radioactive, comes from the very same single crystal. We haven’t even begun yet showing you exactly what this crystal is actually capable of. Not only does it make planes levitate, it makes other things levitate as well. It also draws energy out of the aether like it is as readily available as leaves in a forest and was worshiped as a god in ancient times. Even the reliefs from antediluvian times bear their hidden devices in plain sight and modern science is not only aware of all of these

SUPERFLUID HYDRODYNAMICS

things, but literally use the symbols of those devices now, thousands of years later to secretly cipher which race of beings brought this demon crystal to this planet. You use this deadly, radioactive, cancer-causing crystal to powder your baby's bottom, highlight your eyes, eat off, and surround yourself with it in every corner of your life down to the ring on your finger and the diamond stone fastened to it that saps your energy out of you like a fuel line. It also is the mother of 356 different minerals that produces sulphur, or the very essence of graphite and graphene which is a cipher synonym for Dark Matter superconductors which is a cipher synonym for black body radiation, also known as "black holes" in outer space. Brace yourself.

Bismuth Magnesium is used to make *crystal cell batteries*. You place a Magnesium rod inside a copper shell (like copper pipe), pack salt into the opening around it (like Epsom salt and Borax salt) and then attach wires to the pipe and the Magnesium. And just like that, you have a battery that lasts forever that produces around 1.5 volts from nothing but salt. Salt being the organic capacitor of cation ion energy and Bismuth copper and Bismuth Magnesium being the wife-beaters that forces it to stream Dark Matter inverted electrons:

Cheops SPOKE Pt 1

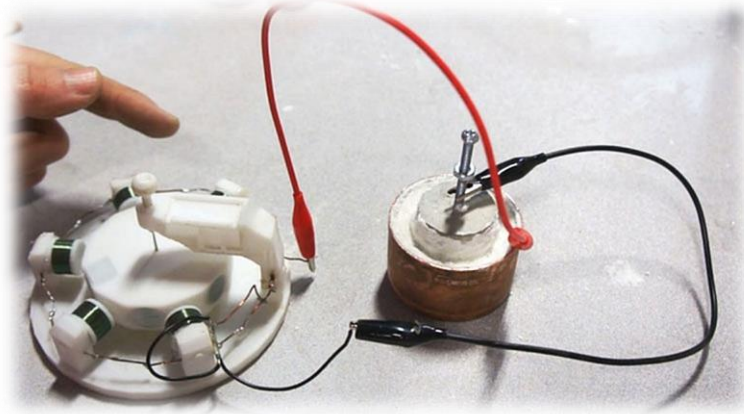

Magnesium vibrates at the same frequency as solar waves within the Red frequency spectrum. Solar rays cover a vast spectrum within frequency measurement, but it has been shown over eons of time that 432Hz has harmonically balanced with the 7.83Hz of the Schumann Resonance which has been a constant since man has been able to measure the “heartbeat” of the planet. Only since 2012 has this fluctuated from this signature which has since risen to over 50Hz, and only due to the incoming ascension waves that are assisting the planet to make the transition.

The color of “Red” within the sonic spectrum lies between **430Hz and 480Hz**. The color of Red is the color of black body radiation, although this has also been ciphered, as Red is actually Grey as covered to some degree in our section on Black Body Radiation under Chapter 39, DARK MATTER ENERGY. Don’t let this confuse you, as Red is the color we use to describe Dark Matter energy when in

SUPERFLUID HYDRODYNAMICS

manifest form that our eyes are actually able to see, the color of fire.

Now realize that solar energy between 432Hz and 480Hz is within the spectrum of the harmonic resonance of the planet itself, and the frequency that trillions of tons of quartz crystals, the carriers of ion energy, vibrate at. In order for a mineral to emulate the frequency of the sun to release this energy, it must vibrate within these parameters. However, 432Hz is more precisely the exact tune of Cold Fusion (organic, stasis energy such as in crystals), whereas 480Hz is more precisely the deepest “Red”, or the most “inverted” release of energy that could possibly be used if you were looking to release Dark Matter. **Magnesium vibrates at 480Hz, or at the precise apex of the frequency of Dark Matter, exactly as far away from Light matter as possible.**

When sun waves strike materials on Urth, it activates (creates) oxygen. Oxygen is code word for energy as we have already covered. No material creates more oxygen than crystals which have been ciphered into the word salt. The oxygen particles then act like tiny spheres of energy that float suspended in air (lifted by hydrogen), seeking any materials that are low on energy to impart their fuel to. You remember this from the section on semiconductors as cation and anion ions. Copper (cations) which has been stripped of almost all of its oxygen continually cries out for more oxygen energy and will continue doing so until it completely erodes and dissolves over eons of time.

Cheops SPOKE Pt 1

*So the crystal cell battery is not sort of like, but exactly like a tiny sun (Magnesium) at the center point, vibrating out sun waves directly into salt which is the carrier of oxygen/hydrogen energy which then releases that energy in the direction away from that sun because salt, like **Magnesium**, is paramagnetic and only conducts electricity in the direction of the applied electret-magnetic field.*

The copper surrounding the salt (which is now bursting at the seams with anion ions yet “still starving”) is continually crying out for that energy, so the energy instantly travels into the copper seeking a new home, only to find out there is a copper wire attached to the shell of that pipe, also depleted of oxygen, so they simply travel through the shell of the battery and down that wire. During that process, anion ions are inverted into Dark Matter electrons which generates a secondary emission that multiplies their power by a magnitude of double what it started out as. What comes out then, is high amounts of Dark Matter

SUPERFLUID HYDRODYNAMICS

energy. All the while remaining cool, because all the materials involved are designed to soak all the thermal radiation heat out of the microscopic grey sparks too small to see, but still create a continuous blizzard of fire.

If Magnesium were to vibrate more like 432Hz, it would release just as much “energy” from salt, but it wouldn’t be as precisely tuned to the frequency as Dark Matter inversion as it is. So in real terms, Magnesium is literally the perfect electromagnetic converter of ions into Dark Matter, which is why a crystal cell battery requires Magnesium at its core for the best possible result. Graphene vibrates to a cut off of 427Hz for example, and while it does still produce waves close enough to the 430-480Hz range to release ions, it isn’t as “perfect” as magnesium is when creating specifically Dark Matter “free electrons”.

Now back to our Aeroplanes.

Magnesium just so happens to be the ingredient that turns aluminum into super-hard aircraft-grade metal that will stay cool even though a fighter jet turbine can reach temperatures of up to 2000C (that’s *really* hot). The bottom line is this: Magnesium blended into aluminum is like adding a trillion tiny suns into that metal which continually activates the Aniline salt crystals in the air to generate

Cheops SPOKE Pt 1

anion ions which then enters the body of the aluminum which has been stripped of all its normal oxygen which leaves what science calls “holes” inside where ions can enter like empty fuel tanks. **So the aluminum then functions exactly like a capacitor to store the energy that the Magnesium is creating.** All in one single, handy metal.

So an earth battery in this form (your front yard will produce similar voltages with just two rods in the ground as well) called a *crystal cell battery* (which is the solid state version of a Baghdad Battery of Egyptian times), combines Bismuth Aluminum and Bismuth Magnesium and Aniline “salt” crystals (Epsom and Borax) with Bismuth Copper which is equated to pure cation ions to use **solid state Magnesium sunlight** to produce free energy:



SUPERFLUID HYDRODYNAMICS

There is a secret about Magnesium which is hidden not very cleverly by its own name. **Magnesium** is made up of highly **magnetic** particles, but their electrons are not aligned such as you find inside of a neodymium magnet, **so it doesn't act magnetic**. So these electrons are random-vectorred (their directions), but like the magnetically-reactive cation ions inside aluminum as well as salt, they are *paramagnetic* as just mentioned. What wasn't explained is that when Borax salt and Epsom salt and alum are melted and then allowed to quickly harden (keeping their crystal lattices misaligned so they don't act like a magnetized metal until needed to be magnetic), rather than contract as normal materials, it expands. This is because Borax and Epsom salts are **also made from Bismuth**. Which means that crystal cell battery is literally made of 100% Bismuth, brought to this planet for one reason; to produce Dark Matter.

Called a "rare-earth crystal", Bismuth **expands** when it cools down from liquid state and reaches room temperature. So when you melt these salts at 801C, then pour that liquid between the Magnesium and copper, it *pushes* against both surfaces. As you remember now, when piezoelectric crystals are squeezed down only 0.1% of their original size, it accelerates the production of its phonon energy.

Let me clarify this point for you here, that when I say Magnesium "vibrates" at 480Hz, I mean it literally sits there and never stops vibrating, just like a sun that never stops shining, so it continues to produce energy all on its

Cheops SPOKE Pt 1

own. But when it is placed into direct sunlight, of course it is going to get an additional boost from the photovoltaic reaction.

So, as you can see, it is the **magnetic field** generated by the squeezed salts inside the crystal cell battery that now *sonically sings* unpaired electrons away from their valence that force the salt to send out their piezoelectric ions which turns this battery **on**. If you were to remove the Magnesium core, letting the salt crystals just remain in a relaxed state instead of under pressure so there was *no magnetic field* being generated, neither one would emit any usable levels of energy.

So how does this play into aircraft aluminum exactly? The secret is aircraft aluminum differs from regular aluminum by the fact it is made with Magnesium, causing every metal surface of that craft to continually apply at least 0.1% pressure on its own atomic crystal lattice, which activates that material to produce massive amounts of electricity and **provides its own sun waves** to continue to activate that energy. The energy in this material is also **accelerated by the addition of greater exposure to sun waves** above the cloud cover where jets always fly.

This makes a 747 passenger jet 100% a crystal cell “Urth” battery, from its seat brackets to its engines, to its superstructure

SUPERFLUID HYDRODYNAMICS

*to its outside sheathing, and 100%
Bismuth.*

Bismuth mimics the Aniline crystal called salt and salt water, which is considered cation ions, or “empty sponges”, begging for oxygen which is energy as already mentioned. The moment they are exposed to sunlight or wind friction, they instantly are refueled.

*When salt particles reach the anion ions in your saliva, it generates millions of **tiny explosions** of secondary emissions that literally **sparks** the flavor of foods to your taste buds. So **cations**, or “salt” which can also come from alien Bismuth (along with organic salts from the sea) can be considered the secret and the magic of the production of energy. This is why they call **parity** or “the magnetic (magic) moment” in neutrino conversion “flavors.”*

Now that you understand that an “aeroplane” is made out of Bismuth, from its frame to its protective coating, and that it is absolutely filled with “holes” for anion energy to readily

Cheops SPOKE Pt 1

absorb into, and is filled with billions of tiny suns inside its atomic makeup that continually produces more anions and then fills the cation “holes” with raw ionic energy, perhaps you can see where passenger planes actually get their “fuel” from. The open air. Aeroplanes are ***gigantic flying batteries*** traveling at hundreds of miles per hour, gathering trillions of negative anion ions every second which recharges them at an exponential rate from both friction and sun waves, vastly greater than the most advanced photovoltaic used in the solar industry. Even when that plane lands or idles on the runway, even on a cloudy day or at night, it continues to generate enough energy to fuel that plane almost **perpetually**.

Stopovers for “refueling” is literally only a ***smokescreen*** to justify the levitation travel of that craft in the public’s mind. The only reason the plane takes on any fuel at all between flights is to make you think that it runs on fossil fuels and not the aether, which it uses only for the display of firing up the engines and spewing flames and heat waves for a few seconds before it is switched over to ions. Now watch a commercial airliner take off and tell me if you are seeing signs that it is running on archaic combustion used by your great-great grandfather or not.

*In fact, since the beginning of passenger flight, pioneered by German Foo Fighter Haunebu crafts, this has been known as **Power Harvesting (also Energy Harvesting)** called the **Peltier-Seebeck***

SUPERFLUID HYDRODYNAMICS

***Effect** by the aerospace industry. Look it up for yourself. In fact, the fuselage and wings of a passenger jet are literally ciphered in the industry as “**thermoelectric generators**” in scientific reports.*

Rather than just come right out and say the word “energy”, they will instead use the term *temperature* to hide this secret. Still, temperature change from anion ions refueling cation ions is in fact “electricity” through secondary emission generation. As you will soon see under the subject of cavity-magnetron energy production (inaccurately referred to as amplification), the *pulsation* of the movement of electricity is caused by anion ions rushing in to every atomic inch of any *covalently-bonded materials* to all universally become the exact same **temperature**. So it is temperature fluctuation by which they have conveniently shrouded this technology:

*Wikipedia: **Thermoelectric Effect**;*

*“The thermoelectric effect is the direct conversion of temperature differences to **electric voltage** and vice versa via a **thermocouple** [two materials of different conductive coefficient such as aluminum and magnesium]. At the atomic scale, an applied temperature gradient causes **charge carriers** [secret term for **cation/anion ions**] in the material to diffuse from the hot side to the cold side.”*

Cheops SPOKE Pt 1

Since we have been indoctrinated to believe there must be movement in order to produce energy, the Seebeck Effect doesn't seem to be something that could possibly be real. But let's take a look at what the experts say about generating energy out of nothing more than the differences between the coefficient of two materials which are then known to be **thermocoupled**:

*Wikipedia: **Thermoelectric generator**;*

*“A thermoelectric generator (TEG), also called a Seebeck generator, is a solid state device that converts heat flux (temperature differences) directly into electrical energy through a phenomenon called the Seebeck effect (a form of thermoelectric effect). Thermoelectric generators function like heat engines, but are less bulky **and have no moving parts.**”*

As the arched wing edge begins pushing its way through the thin water we call air, it forces the ions into an excited *torus* state circulating around the wing, where the air reaches what is known as the *breaking point* where the static electricity from one ion will leap into another ion that has less negative charge than the ion sending out the spark. But you don't see a spark from the air zapping into the wing or nosecone of the aircraft, because each transference of electron from the ions happens by the billions in individual transfers below your spectrum of sight **and are grey, exactly the same color of the aircraft aluminum** so they are absolutely invisible to the naked eye. Yet each one creates secondary emissions, more than doubling their

SUPERFLUID HYDRODYNAMICS

energy as they go into the proton/cation sponges of the aluminum. This torrent of super-accelerated energy then creates a massive zero point.

That's where we come back to the cyclone that is being developed by the shape of the wing that triggers laminar air flow around its surface. This cyclone vortex of extremely high wind-forces creates a **sonic harmonic pitch**. The **hollow** wings of the plane are tuned to this exact pitch, causing the dozens of separated chambers inside (you are told hold fuel, but are really *ultrasonic resonance chambers* as well as *resonant inductive couplers*) that now generate a hum that harmonizes with the mass frequency of the aircraft body which forces all the unpaired electrons in the capacitor to hold hands:



Cheops SPOKE Pt 1

This creates a magnetic field around the craft and both the laminar “sheet” that keeps air from ever touching the wing, as well as the “low pressure area” above that science claims lifts that craft into the sky. You just created *Cooper Pairs*, turning that wing into a *gigantic Meissner Field superconductor* and it is now being **levitated** through **quantum locking** between its **Magnesium (magnetite driven magnetic field)** structure and the **ferromagnetic iron** of the Urth below that is **repelling** it up into the sky. In other words, that plane turns into a *physical matter that is also a non-matter*, just like ormus.

Remember, when *ormus* is physically connected to something else, like the tray holding it up inside the sealed weight scales, it becomes one with that thing. So the torus surrounding the wings that are attached to the plane body envelope the entire structure in a massive torus field and places the wings and the hull inside of a zero-point suspension zone. Now all the turbines have to do to keep it moving forward is offer some thrust and rather than just levitating, it is now “flying”. When that jet goes through too many ion-depleted air pockets and uses up too much of its energy from the aluminum, it comes to a complete halt and has to sit there long enough for the sun waves to recharge the capacitor again enough to restart the engines.

Of course this is rare, so the collective consciousness of the planet never sees this enough to break the coma-state it is in to realize this is what is happening. This aeroplane was videotaped sitting right there in one place at least 15 seconds while the photographer was traveling down the

SUPERFLUID HYDRODYNAMICS

freeway. This is not just a still capture. It continued to sit right there in mid-air at a dead-stop as he drove past and was not an “optical illusion”:



Aerospace crafts and *aeroplanes* are Dark Matter *aether* planes. AEro stands for Æ from ancient Latin. The a+e stands for the LAW in old English, but in ancient Latin it stands for **ash**, or **the very thing that aircraft aluminum is designed to emulate**. Graphite carbon lacking all oxygen. How in all of space and time could **ae**, the **precise distinction** of the type of crafts that “fly in space” ever have the highly specific origin of the very word used to weaponize every electric transformer around the world, ash, that would thousands of years later be used synonymously with **the law**?

Cheops SPOKE Pt 1

And of course by now you have already realized that the designation of Æ is really all about the Æther , which is why Enki's letters are EA , read from right to left. It is **the law of Dark Matter physics** that allows such planes to defy gravity to such a degree as to transcend all known Urthly physics.

CHAPTER 11

ULTRASONIC AIRBORNE LEVITATION



We see birds fly, insects fly, and bumblebees that have been definitively shown by modern science as not being able to fly, yet they still do. And we think that by flapping their wings, this is them pushing downward against the air, which pushes their bodies upward which allows them to remain suspended. But this is not true. While some species of birds do actually “fly” by flapping their wings, for many

Cheops SPOKE Pt 1

who we do see levitating, it would be just as fruitless as when man attempts to make wing extensions for his arms and jumps off a cliff. Some birds are ultralight in weight and sonically tuned to reach a state of continuous gliding, but not all. For anything too heavy, pushing the wings upward only to then push downward again doesn't create levitation, as we have seen in old examples of the first helicopter that attempted to use a disc that was meant to do this very thing. All it wound up doing is hopping up, then pounding itself back into the ground over and over with each reach:



I realize that the wings of birds and insects are pushing straight down, then scooping back up to make another thrust, working much like a helicopter that uses a fan above to continually push downward. But the weight of insect

ULTRASONIC AIRBORNE LEVITATION

bodies and many bird bodies are simply too heavy for this equation to keep them suspended. Yet we accept that they can do this, but man can't as if it is a magical difference between the two. It isn't, and that is what this chapter is about, because the sonic propulsion that actually allows these airborne creatures to remain aloft is the same sonic energy that totally electrostatic energy generators once used to power communities.

Flapping wings generate *sound*. The sound is what allows birds and bees to levitate. Sure, eagles can also float on wind currents using those wings, but so can man. The only difference is we are not tuning the hollow aircraft aluminum framework of our wing extensions to sonically resonate with our physical mass to reach *sympathetic harmonic resonance* that calls out to the ions in the air that generate Meissner Fields that actually powers levitation of that flight.

The internet sensation that has arisen over extreme claims that a scientist was able to fly at incredible speeds on a board he had fastened insect wings to the bottom side has been debated and debunked, claiming that like any other ridiculous hoax, this one was obviously moronic. No one can fly just by putting wings that don't move under their feet. We should all know better than that. The problem is, there is plenty of scientific evidence proving this was no hoax, even if the rest of us have never heard about the topic before now.

Cheops SPOKE Pt 1

As I have pointed out, when seen under a microscope, sand is made up of crystal and the calcium shells of tiny creatures such as shellfish, etc. All of which are actually crystal. And as you know by now, piezoelectricity is coaxed out of crystal just by placing it under pressure or placing it in the waves of the sun. Sometimes the creature that grows its calcium crystal shell adds minerals to the mixture that act just like liquid glass that expands when it hardens, which not only makes its shell and framework much stronger for structural rigidity and protection, but excites the piezoelectricity to emit from its shell naturally. Here is an excerpt from a scientific paper showing the results of testing one such type of shell:

*Reaserchgate dot net; Tao Li; **Piezoelectric properties and surface potential of green abalone shell studied by scanning probe microscopy techniques;***

“It is found that the stronger piezoelectric response is associated with the higher surface microhardness in the abalone shell.”

ULTRASONIC AIRBORNE LEVITATION

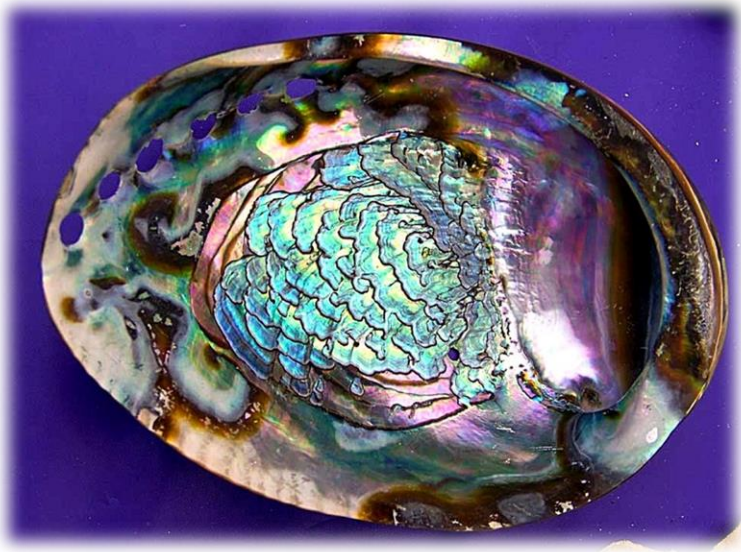

While a natural crystal seems to grow in a stasis state where its piezoelectricity remains for the most part dormant, there are many creatures who grow their own calcium crystal shells and wings in the same way as the green abalone used in the research above, making their homes and transportation devices much more impervious to the elements, while at the same time *emitting a continuous ultrasonic piezoelectric signal*. Each time you see this visibly pronounced “super hard shell”, for some reason there is a magnificent (note the spelling of that word) *iridescent sheen*. We’ll come back to this in a moment.

It was explained to me by my contact that a bird’s natural flight occurs from the ultrasonic resonance chambers inside their composition, not from flapping their wings so air can suspend them. Flapping their wings only generates

Cheops SPOKE Pt 1

the ultrasonic torus field and *also* pushes them forward, like engines on aeroplanes that provide forward movement. In this instance she was explaining how a duck whose body weighs too much for their comparatively small wings can still somehow fly;



Aerodynamically speaking, to displace enough air to support this much body, the wings on this duck would need to be twice as long to lift this porker into the air, yet he flies anyway.

By now you likely have already heard that the bones that make up the skeleton of humans and animals are calcium. This is pretty common knowledge. What you haven't been told is calcium is pure, concentrated, *paramagnetic crystal*. And paramagnetic crystal is *full* of piezoelectric ions because at a molecular level, that bone is filled with "holes" that science refers to as cation ions that are always

ULTRASONIC AIRBORNE LEVITATION

calling out for energy. In larger examples they are called sonic resonance chambers. This makes every living creature full of organic, eternal energy. Humans have it, dogs and cats have it, and so do birds and flying creatures.

In the case of flying insects, the bumble bee isn't the only one whose body is aerodynamically speaking, far too heavy for the tiny wings that are supposed to allow it flight. Yet they do fly, and by the trillions, all around us:



In trying to explain the phenomenae of insects with bodies too big for their little wings to keep them aloft merely by flapping, the *Bumblebee Paradox* sparked researchers in 1996 at the University of *Cambridge's Department of Zoology* to build scaled-up robotic models of insects to study in detail the airflow around their flapping wings.

Cheops SPOKE Pt 1

Headed up by *Animal Mechanics* specialist *Charlie Ellington*, the team found results that seemed to solve the conundrum. They discovered that “extra aerodynamic lift” (unexplained loft) was generated “*by a vortex travelling along the leading edge of the insect's wings during a downstroke*”. This vortex satisfied the researchers, without ever getting down to how a vortex provides additional lift. But then, unless they were aware of superconductors, Meissner Fields, Cooper Pairs and how paramagnetic crystals create magnetic fields to allow the superconductor to place something outside of the boundaries of gravitational push, their published results wouldn't actually explain it anyway.

In the duck's case, as *typical birds of flight*, the feathers of their wings, and their bones are hollow. This is called a *trabeculae* when there is no marrow in the bone, something all birds simply have, while typical land-locked creatures' bones are filled with marrow. Those bones aren't hollow just to make them lighter so they can “float in the air”. They are additional “holes” or sonic resonance chambers. When they hum in resonance with each other, it releases secondary emissions, generating an electrostatic magnetic field. All they need below them to produce a Meissner Field now, is iron to repel away from. *Urth is 5% iron.*

The reason this subject came up at all, was over where I chose to do my work at the safe house, as in correlation to the location of where the sanctuary birds were protected close by. My contact visited me there in person one day while I was hammering and cutting hollow, resonating steel

ULTRASONIC AIRBORNE LEVITATION

rails for one of the structures I was installing, and she explained that the noise I was making was bothering the birds. I honestly didn't give it much mind, since I had an important job to do; in fact I was in the process of building the very aviary itself at the moment where those ducks would call home in the next few days.

Of course she sensed that I didn't really understand, so she explained that the entire skeleton of the duck was hollow just like their feathers, sonically connected to their lungs, making that entire bird a harmonic resonance chamber and the sounds I was generating with my saw blade on the hollow pipes echoing out of the natural gas tank I was using as a work bench could actually *kill* them. That finally got my attention. It would be sad to spend a few hundred hours building an aviary that would be empty.

I had no idea then that I would receive direct telepathic messages from my higher self to write this report (not in actual words one can hear, but merely messages that my body or more precisely my pineal gland, understands) some few months later, and ask me to write this message I am documenting now where I would learn all about sonic and ultrasonic resonance, because that's really the biggest secret behind how pyramids actually generate power.

If you would have asked me then to explain to you anything about the pyramids, I could have told you that they get their energy from the Deuterium heavy water that

Cheops SPOKE Pt 1

sits below and is amplified by the cone-shaped pyramid above. Little did I know it was only about a thousand times more complicated than just that, and my higher self was intent on letting me know every little detail about it before I was finished writing what I thought was going to be a 10 page article on the matter. Seven months later I am still writing around the clock.

Birds of the air are sonically tuned from beak to tail feathers as one harmonic unit so-to-speak. When they flap their wings, it creates the same cyclone vortex effect around them as created by any plane much heavier than a glider. For heavy birds, their wings emulate the same toroidal field that aeroplane turbines do. The frequencies generated by this whirlwind transfer into the ultrasonic sound chambers in their skeleton and feathers which strikes a harmonic resonance between the two.

That sound *pressurizes* these chambers, which then causes the crystal calcium to emit piezoelectric waves, which once again causes the anion ions flowing around the wings to generate a zero-point levitation field. As long as the bird continues to flap its wings, the energy from the ions in the air will continue to stream into the crystal which continues to generate the magnetic field that envelopes the bird and its wings inside a Meissner Field. And of course, then the ultralight feathers push off from the turbulent air behind them, allowing them to continue to move forward.

ULTRASONIC AIRBORNE LEVITATION

The scooping motion of their wings allows them to rise higher in the air or move forward or both, but it absolutely does not provide them the lift to offset gravity if their weight is higher than a certain ratio which has to do with gravitational equilibrium I suspect. My contact has made it clear though, that some birds do in fact “fly”, while others use this technology.

Birds close to the ground move their wings much faster than birds much higher in the sky where the air is much purer, making the ions up there much more readily accessible. This causes eagles or geese flying in formation to seem like they are moving forward almost effortlessly. And even though the air is much thinner (less oxygen and therefore less ions) at these elevations, rather than flapping its wings twice as fast as 20 feet off the ground, it acts just the opposite. And yes, there is a difference between the usable ions in the air close to the ground and air that is above the clouds. You know, that place where every passenger jet pilot insists on having to be?

In a statement released about the newest version of lithium-ion batteries that could produce 10x as much power as they currently do, just by filtering the air that provides their energy, **Argonne National Laboratory** made this statement on this new battery research. (Note that he is using the term air as *synonymous* with anion (-) ions):

“Unfortunately, experimental designs of such lithium-air batteries have been unable to operate in a true natural-air environment due to the oxidation

Cheops SPOKE Pt 1

of the lithium anode [this is the main crystal capacitor] and production of undesirable byproducts on the cathode [this is the cation-ion graphite/ graphene/ sulfur/ ash electrode that brings in the energy into the capacitor crystal] that result from lithium ions combining with carbon dioxide and water vapor in the air.”

So birds are literally able to fly much faster and with less effort much higher, even though the air has less oxygen, which in itself is a contradiction. It is only because of the purity of that air that makes for this difference. While you and I would be out of breath immediately running in thin air, the power that is actually pushing that bird forward through levitation makes their travel nearly like a resting state where they have to move their wings only casually compared to flapping like mad to leave the ground. And the reason is simple; we have contaminated the air around us down here below and our ions are “coated with gunk” (which is what is hampering the “cathode” referenced in the report above. Once high atmospheric ions have traveled up through the cloud cover which cleanses them like a filter, they are able to transfer into the electrostatic torus field surrounding birds and aeroplanes much more efficiently, which according to the Argonne National Laboratory report, that energy potential is *tenfold* higher.

I am sure you have answered this question for yourself already, why it is there is no heat transfer from the electromagnetic field surrounding the bird like there is with aeroplanes that need to be made from ultra-heat-conducting

ULTRASONIC AIRBORNE LEVITATION

aluminum (which would otherwise turn them into airborne fricassee of fowl). It is because birds aren't turning photonic ion energy into electromagnetic energy, so there is no thermal secondary emission. The secondary electrostatic emission is ionic emission which has little to zero heat signature. They leave the energy entirely inside the grounded shield it came in for want of a better explanation. Thermal emission only occurs when we take energy out of its "wrapper" and expose it to the open air by using conductive materials like aluminum, copper, gold, etc. Magnetic ions (stasis, static, photonic) still respond to magnetic fields generated by stasis energy, exactly the same way they do while in electromagnetic (unpaired, open air) form. The only difference is they are safe "ions" rather than dangerous "electrons".

In the second half of Cheops SPOKE we will cover the nuts and bolts of how the pyramids employ incredibly advanced quantum technology to activate and operate the Global Cold Fusion Energy Temple Network, beginning with the man who used the alien crystal to fly at 900 mph and how it is this energy that brought together the pyramids.

See volume 6; Cheops SPOKE Pt 2 in the decoding the hive human handbook series at decodingthehive.info.

If the truth is going to make it out to the people, then the people reading the truth will make that happen. By going back online and writing a review of your experience with this handbook series, you significantly raise awareness for its distribution to others who like you, really do care about what is real and what is an illusion. It's up to you to spread the word. If you picked up your copy directly from our website decodingthehive.info, then please drop me an email at decodingthehive@gmail.com with your honest review. Otherwise, leaving one online on Amazon or the like really does increase our reach through search engines.

–mission guide

Human Handbook Series decoding the hive

Vol 1: Scalar Vibrational Mechanics

Vol 2: Spacetime Fabric

Vol 3: The Power Of The Gods

Vol 4: The God Particle

Vol 5: Cheops SPOKE Pt. 1

Vol 6: Cheops SPOKE Pt. 2

Available at decodingthehive.info