

decoding the hive

gravity, light, time and the god particle

vol one and two

ILLUMINATI
I open this eternal orb,
& freely pledge
TO DEDICATE MY MIND TO
THE DISCOVERY OF
THE WORLD'S EDGE
TO DEDICATE MY SOUL TO
THE PURSUIT OF
ENLIGHTENMENT
TO DEDICATE MY EFFORTS TO
THE PROMOTION OF
WISDOM
TO DEDICATE MY EXISTENCE TO
"ENLIGHTENING" ALL PEOPLE
IN ALL PLACES, IN ALL
"UNOFFICIAL"
AND TO DEDICATE MY LIFE AND
DATA TO THE FURTHERANCE OF THE
PREFECTURE AND IMPROVEMENT
OF THE HUMAN SPECIES
ON THIS DAY OF
1878

Decoding The Hive

creation of gravity, light, time and the god particle

decoding the hive

mission report vol one and two

creation of gravity, light, time and the god particle

revealing the tools of mankind's enslavement
final ascension cycle Co-Evolution BioRegenesis Treaty of Palaidor

by **avalon sol**
mission guide

original text on behalf of the Guardian Alliance - Azurite Universal Templar Security Team - Emerald Council - in association with - The Interdimensional Association of Free Worlds

Illustrations original and sourced from public domain
Copyright 2017 – all rights reserved
–decodingthehive.info–

Decoding The Hive

creation of gravity, light, time and the god particle

NOTES:

- *On Decoding The Hive (.info) website you will find various companion articles appearing and disappearing as council wishes. You are demanded to push yourselves to recognize the applicability of the esoteric to the mundane of every day, day by day.*
- *This report will occasionally be quoting some text from Wikipedia, which is a known Kybal disinformation platform. The only time it is quoted here is when the information has been independently researched from other reliable sources considered to be the most accurate details available in condensed form for the reader's benefit. Do not confuse these selections as a blanket endorsement of that or any other platform. Always cross verify any details you find there or anywhere else. Unlike Snopes, which is effectively nothing but disinformation when it comes to critical issues, Wiki does have many facts relatively correct as far as current historians agree to be accurate on otherwise random subjects to researchers backed up by laboratory results and multiple sources from across the spectrum. In those cases when I already know the report to be accurate within the scope of what is accessible, I will share the information with you as a starting point for your own frame of reference. Much of the data contained therein, if not most, is not 100% accurate and that is absolutely by design.*
- *All subject matter included in this disclosure has been researched extensively and in some cases continually for years before the untold story could be told. The accuracy of the statements made herein are within the limitations of being behind enemy lines using many sources including Wikipedia as more of a synopsis-site for wide-user contributions by historians and leading subject experts. This entire work can and should be vetted for accuracy across other sources before accepting even a single claim as fact. If you find any details that are misstated here, please contact me so they can be updated. ~avalon*

Decoding The Hive

creation of gravity, light, time and the god particle

volumes one and two

Table of Contents

vol one

FORWARD 9

1 TIME DILATION 10: RESEARCH 12, CLOCKS DON'T ACTUALLY KEEP TIME 13, MATH DOESN'T ACTUALLY WORK 15, CALENDARS DON'T ACTUALLY WORK 18, THEORY OF RELATIVITY DOESN'T ACTUALLY WORK 19, SPOOKY ACTION AT A DISTANCE 21, MICHELSON-MORLEY EXPERIMENT 23, SPATIAL RELATIVITY 25

2 CLOSE ENCOUNTERS OF THE 1ST KIND 26: CONTACT 26, INTERDIMENSIONAL LIGHT SHOW 28, OTHER THINGS 36, STASIS 37, METAPHYSICS 39

3 MISSION RESURRECTIONS 42: INDIGO TYPES 43, RESURRECTIONS 48, THE AGENDA OF THE IAFW 54, CONTRACTS AND STAR GROUPS 55

4 THE LAW OF INTERDIMENSIONAL PHYSICS 58: THE DISINFORMATION MACHINE 59, ACTUAL REALITY IS AT THE CORE OF THE ONION 61, UNDER A MICROSCOPE 63

5 THE SECRET OF ALL SECRETS 77: QUANTUM PARTICLES 78, ENERGY PARTICLES 80, BASIC MAKEUP OF AN ENERGY PARTICLE 81, INSIDE EACH ATOM 82, QUARKS 82, PROTONS AND NEUTRONS MAKE A MAGNET 84, FUNCTION OF MAGNETIC POWER 84, BELOW GLUONS 86, PARTIKI UNITS AND GLUONS 87

6 DNA MAGNETIC PUSH AND PULL 91: PARTIKI ENERGY UNITS 93, ELECTROENCEPHALOGRAPHY 94, SCALAR VIBRATIONAL MECHANICS 95

7 VISIBLE REALITY FIELD 103: VANISHING POINT 106, BIG THINGS AND LITTLE THINGS 109, GEOMETRY OF FIRE LETTERS 110, PRIMAL SIGNET KEYLON 114, ELECTROMAGNETIC ENERGY 116, EIGHTFOLD WAY 118, INFINITY 120, AMPLITUDE IS VOLUME 124, WAVELENGTH IS DISTANCE 125

8 PAPAL KEYS TO THE KINGDOM OF GOD 131: WHAT IS A KEY? 132, PAPAL KEYS 132, WIZARD HATS 136, THE ZETA-DRACO OBELISK LOW-FREQUENCY FENCE 138, BRAIN MAPPING 141, STANDING SCALAR WAVES 142, RELIGION 145, THE SPHERE OF AMENTI 146, KEY TO THE HOUSE OF DAVID 147, THE THREE KRYSTS 148

9 THE HISTORY OF THE PENTAGRAM 151: POLE REVERSAL 152, NIBIRUEAN DIODIC CRYSTAL ENERGY TEMPLES 155, ARCHITECTURAL COMMAND TEMPLATES IN USE 156

Decoding The Hive

creation of gravity, light, time and the god particle

10 ARTIFICIAL INTELLIGENCE 161: ARTIFICIAL INTELLIGENCE (POSSESSION) – PSYBOURJHS 163, CHEMTRAILS 165, ALIEN IMPLANTS IN ALL HUMAN LIFE 170, VAGUS NERVE 172, NEUROPHONE MIND-OF-GOD PATENTS 173, THE HEART PRANA SEED 175, THE CADUCEUS 176, HIPPOCRATIC OATH 177, AETHER COMMANDS AND SENTIENCE 178

11 THE CRONUS PROGRAM 183: THE WORLD IS A STAGE 186, YOUR CORPORATE INVENTORY NUMBERS 189, GLOBAL SPACETIME VECTOR DELINIATION 191, THE MOIRA 192, FLASHLINE SEQUENCING 193, PLANETARY PARTICLE RATES 195, MUTATED SEXTANT CLOCK AND THE SECOND SUN 199

12 CREATING SPACE AND TIME 200: PLAYING FIELD MAPPING 202, SCALAR GRIDS 203, FLASH LINE SEQUENCES 210, CREATING THE FABRIC OF SPACETIME 211

13 PIXELS OF THE SPACETIME FABRIC 214, LIGHT BENDS 216, SPACE AND TIME STRUCTURING 221, TIME IS AN ILLUSION 223, GRAVITATIONAL TIME DILATION 225, TIME IS RELATIVE 226, TIME REGULATED BY DEUTERIUM 226

14 LUNAR EARTH COMMAND MODULE 230: CIRCADIAN RHYTHM AND LUNA 231, MELATONIN MANIPULATION 233, MELATONIN REDUCTION BY THE COMMAND MODULE 234, METRONOMES 237, THE BRANE 239, TEMPORAL LOBE AND CIRCADIAN RHYTHM 241, LUNA LIGHT IS COLDER THAN ZERO LIGHT 243, LAMBERTIAN COSINE LAW 247, FOSSIL FUEL AND THE SCHUMANN RESONANCE 255, WHAT OIL ACTUALLY IS 257, FLASHLINE SEQUENCE 258

15 JET LAG AND SLEEP INERTIA 260: ELEVATION ATMOSPHERES 261, ELECTROMAGNETIC PLASMA FIELDS 263, MORE JET LAG 264, SLEEP INERTIA 269

16 THE BLACK SUN 271: THE INKY BLACKNESS OF SPACE 276, THE BLACK SUN'S INVISIBLE RAYS 279, EARTH, SUN, MOON SET THE FLASHLINE SEQUENCE 282, LIFE IS MADE UP OF CREATED SENSES 284

DECODING THE HIVE VOLUME TWO 303

TABLE OF CONTENT VOLUME TWO 306

Table of Contents **vol two**

Decoding The Hive

creation of gravity, light, time and the god particle

18 AETHER 101: THE POWER OF THE GODS 309: ROCKET SLEDS TO HELL 310, THE BIG PICTURE OF TINY PARTICLES 311, SUN, WIND, RAIN AND THE GODS 315, THE TRINITY THREE 317, INTRODUCTION TO THE S@t@in Cyphez 318

19 GLOBAL ENERGY DELIVERY SYSTEM 325: SUN“LIGHT” IS A CODE WORD 325, SEE THE SUN’S PULSE RATE WITH YOUR OWN PINEAL GLAND 326, RECHARGING THE PLASMA BODY 331, THE OMNIPOTENT POWER OF RA 332, THE SUN OF MAN (LIGHT AND LIFE) 332, GLOBAL ENERGY AND DEUTERIUM 333, GOD PARTICLE AND CERN 335, HYPOTHESIS OF LIGHT QUANTA 336, HIGGS BOSON 338, DEUTERIUM IS THERMONUCLEAR FUSION 339, TYPES OF HYDROGEN 341, MASS IS 3RD DIMENSIONAL LIGHT 342, HYDROGEN: CODE FOR ION ENERGY 344, URANIUM PURE OXYGEN IONIC CONDUCTOR 346

20 THE SCIENCE CYPHER: 353: ATOMS, IONS AND SUBATOMIC PARTICLES 354, MAGNETIC ENERGY 355, ATOMIC “MATTER” 356, ADAM AND EVE AND ELECTRONS 356, TURNING INTO AN ATOM: ANTIGRAVITY 358, CRYSTALS ARE AETHER PARTICLES 361, IONS AND NEUTRINOS 362, MULTIDIMENSIONAL NEUTRINOS 363, DEFINITIONS OF NEUTRINOS 364, WAVES ARE RELAYED 368

21 THE NEUTRINO CADΣ: LEPTONS V_e, V_μ, V_τ 372: THE NEUTRINO CADΣ: LEPTONS V_e, V_μ, V_τ 374, LEPTON ELECTRON V_e 375, LEPTON MUON V_μ 376, MASONS ARE MESSENES 379, LEPTON TAU V_τ 385

22 THE NEUTRINO CADΣ: HOLY TRINITY 387: MU OF MUON = VOLTAGE 389, NU OF NINHURSAG SECRET Y AND V 390, ELECTRONS (-) 391, PICTOGRAPH TO CUNEIFORM 392, V IS GOD 393

23 THE NEUTRINO CADΣ: ALPHA AND OMEGA 398: TRI VECA CODE 399, NEUTRINO LEPTONS (+) AND IONS (-) 400, WAWWU AND SCIENTIFIC SIGNETS 402, OMEGA ELECTRONS 403, INSIDE AN ATOM 405, ALPHA MEANS DARK MATTER 406, HOW V MEANS DELTA + ALPHA + TRINITY 407, FINDING THE GOD PARTICLE 408, DELTA SYMBOL ALPHA AND THE ΔMEGA: $\Delta = V$ 416, BROKEN MATH 417, THE HUMAN PATSY 418, FINDING THE FAITH OF A MUSTARD SEED 419, LATTICE HYDRODYNAMIC THEORY MATHEMATICS 419, THE VACUOUS TRUTH ABOUT NUMBERS 420, LATTICE ORDER 423

24 THE NEUTRINO CADΣ: HIGGS BOSON 426: SCALAR FIELDS 428, QUADRANT VECTORS 431, NEUTRINOS ARE BOSONS 432, OXYGEN AND ALPHA PARTICLES 433, SAL(T) 435, THE MATRON OF MAGNETICS 436, THE ANUNNAKI PARTICLE 437

25 THE NEUTRINO CADΣ: MOMMA 442: BLOOD AND OIL 443, THE NEUTRINO EVENT 446, SCIENCE AND SYMBOLS 449, MOTHER OF ALL LIFE: MOMMA 452, WAWWU IS CODE FOR EVE 455, EVE IN A NUTSHELL 457, KRYSTAL SEED ATOM ALPHA AND THE OMEGA 458, IOTA = ION 459, THE IONIA EVE LEPTON 460, THE EVE (WAWWU) PROGRAM 461, THE FLIGHT OF PETER PAN 463, TRIFORCE OF THE DRAGON 467, ANGELS CAN FLY 468

Decoding The Hive

creation of gravity, light, time and the god particle

26 THE NEUTRINO CADΣ: SCIENCE SYMBOLS 470: SAL(T) = NABLA = DELTA = ALPHA 474, DELTA/ALPHA = THE ALPHA AND THE OMEGA 475, EVE/WAWWU/SAL(T) = OXYGEN 476, EVE/WAWWU = SALT WATER GOD 477, GAMMA RAYS = WAWWU = ELOHIM 477, SCIENCE SYMBOLS SYNOPSIS 479, SIGNETS OF THE ANNU-ELOHIM 481, NUMEROLOGY 483

27 THE FIRE LETTER OF THE WHITE QUEEN 485: COMMAND PROGRAM TEMPLATES 488, FIRE LETTERS 488, EXAMPLE OF THE CREATION OF A FIRE LETTER 490, SCIENCE OF THE COMMAND SIGNET 491, REFERENCE CHART KEYLON COMMAND TEMPLATES 500, CREATING THE SIGNET 501

28 LIQUID ELECTROMAGNETIC ENERGY 511: QUANTUM MERKABA ENTANGLEMENT 512, PLANETARY BODIES 514, THE LIE OF FOSSIL FUEL 517, DEEP GREEN ENERGY 526

29 GRAVITATIONAL PUSH 528: WATER TYPES 530, HEAVY WATER GRAVITONS 531, THE GRAVITON 533, REENERGIZING DEUTERIUM GRAVITONS 534, THE BIG SECRET ABOUT THE SUN 538, LIQUID LIGHT 540, SWIMMING IN DEUTERIUM 540, SUFFOCATING IN THIN AIR 541, ION ANILINE GRAVITON 542

30 PLANETARY ENERGY 545: THE CREATION OF GRAVITY, HEAT, LIGHT, LIFE AND TIME 546, NEUTRINOS + ANILINE = GRAVITY 548, THREE ELEMENTS MUST BE PRESENT TO CREATE ILLUMINATION 552, ENERGY INVERSION 553, EGYPTIAN ELECTRICITY 555, NUCLEAR KRYPTONITE 558, WIRELESS LIQUID ENERGY 559, IONS AND UNLIMITED GLOBAL POWER 561, SNOW 562, MOTHER NATURE'S ETERNAL ENERGY PLATFORM 562, SEA LEVEL GRAVITATIONAL EQUILIBRIUM IN PSI 566

31 MECHANICS OF THE SPACETIME FABRIC 569: HOW LIGHT, HEAT, TIME, MASS AND GRAVITY WORK 572

32 CODE OF THE KRYSTAL SEED ATOM 577: RESURRECTIONS 577, KARMA IS AN OPERATING PARAMETER 579, THE CODE OF THE AETHER 581, KRYSTAL SEED ATOMS 581, PLAGIARISM 582, BEGINNING OF THE FALL 585, BORJHA RETROVIRUS INFESTATION 585, THE REAL GENIES IN THE BOTTLE 590

33 THE REAL GOD PARTICLE 593: THE MILLENNIA PHOENIX 594, HIDDEN X FACTOR 598, THE METATRON CUBE 599, THE HEXAHEDRON TETRAHEDRON 600, THE GOD PARTICLE, THE SIGNET OF AN 602

Decoding The Hive

creation of gravity, light, time and the god particle

Decoding The Hive

creation of gravity, light, time and the god particle

FORWARD

I AM going to make it easy to skip reading this book for those of you who have no idea of what might be inside and are still considering this educational series. I am an official representative of the **Azurite Universal Templar Security Team** from **Sirius-B**, **Palaidorian Oraphim** angelics of the **Guardian Alliance**. We are the military extraction team assembled for the removal of the **Angelic Humans** along with various human hybrids now being refined in preparation for ascension under the bonds and conventions associated with the **Emerald Covenant** and the **Co-Evolution BioRegenesi Treaty of Palaidor** who were captured or otherwise abducted by multiple races from other interstellar origins inside and out of this solar system who willingly broke the **Emerald Covenant** and entered this sacred culturing ground. If you do not believe we exist, then you are wasting your time with this disclosure. The humans who were officially seeded to this playing field 560 million years ago came here under the understanding that they would be visiting for a very short time, then returning directly to the Deity Planes where their adventure began. This did not happen, and the carnage that has resulted from this insidious invasion has been out of control during the duration of their visit. We are here to end that abuse on no uncertain terms. This paper was not written for those who still imagine they may be alone in the universe, as you are not yet ready for the realities of interdimensional existence. I will not be making any apologies for what is written in these pages. These happen to be the truths and facts as accurately as can be explained using the corrupted languages of this playing field and if you don't care for hard realities then you need not waste your time attempting to learn the concepts of advanced science, self-reliance and what the word authentic means. The time for games is over. We will only attempt your extraction this one last time, then the **Turaneusiam Project** (Angelic Human Experiment) will be over and we will not be coming back. If you choose to continue to read regardless, realize that once you know, you will no longer be able to claim naivety when facing your final review.

avalon sol
mission guide

CHAPTER 1

TIME DILATION



In early 2013 I was startled awake from twilight sleep with the words **TIME IS A LIE** across the back of my eyes. The vision was stark and distinctly vivid, written in gigantic white, capital block letters, wall-to-wall across my closed eye lids. It wasn't a dream, as I could read it clearly. Since it was literally pasted to the back of my eyes, there was no possible way *not* to read it.

I couldn't have mistaken this for anything I had ever experienced before. It was clear this was a message, but I had no idea from where or what it could *possibly* mean.

I had received a few visions before in my life, on rare occasion. When I did, they were usually something to do with an invention I had been working on, and when they came, they were crystal clear images of how something would work in real-time physics, not like a hazy dream. I didn't know why I would get the visions, but when I went to my research lab to test them, they worked. But this time, the vision made absolutely no sense to me, as it was clearly a message, not an

Decoding The Hive

creation of gravity, light, time and the god particle

image, and I had no idea how or why it appeared. *Where* did this come from and *WHAT* was it trying to say?

It is well known within the scientific communities that the most impressive minds bringing the most revelations about science, physics, space, etc., have always stated that they get their breakthroughs through visions that simply drop into their head while in twilight (4 to 8Hz Theta state) sleep and they don't know where they come from but they just so happen to be accurate (or what their limited understanding about true physics allows them to comprehend). Steven Hawking, Dmitri Mendeleev, Albert Einstein, Niels Bohr and many others come right out and say this is exactly how their "genius" came to them. Sure, they were *smart*, but not like this.

(Such visions are not always placed into minds by benevolent beings, even though we would consistently like to attribute such revelations to a benevolent "god" from somewhere. Sometimes, in the case of Albert Einstein for example, they are placed there in order to lead humanity down a certain path for reasons that harbor no good intentions for mankind at all. In his case, he was used as a pawn by the dark forces that I can expand on later. The Kybal has made it standard operating procedure to enlist unknowing pawns with exceptional abilities to mislead in order to make an impact on the population for their own purposes, always making the contactee feel important or special. That sense of self-important typically clouds their judgement from the outset, rendering them little more than a hand-puppet of someone else's agenda. This is not my case. There are millions of people out there who could do my job and I am under no illusions that I am unique or exceptional. I am merely here struggling to do what might appear on the surface as an impossible task or more than that, a suicide mission. This paper is written in third-party form because should something end my ability to continue, it will not be the name of the writer, but the voice itself coming through that you will want to continue to seek over the course of your journey for further instruction and clarity. Like J. K. Rowling, Mark Twain or Agatha Christie, I write under a pen name. I am not here to kid anyone, but merely wish to remain alive so I can continue writing.)

In my case, I had no knowledge of formal science, even though I was a self-taught physicist and inventor. I considered everything that "formal" education taught was a bunch of foolish nonsense and stuck to my own empirical observations because what science claimed to be "real" simply didn't work in a controlled and consistent environment, at least not the things I was interested in. They worked under conditions that had been concocted and then isolated from one another, not linking other "controlled results" from their own observation with other scientific results which contradicted theirs. These conflicts are typically not reported to the public and are supposed to just magically vanish when someone notices them, remaining simply unexplained.

And yes, my multiple patents weren't just benign gadgets that buttered toast automatically. Some have changed industries around the world because they were using science in an unconventional manner, unstrained through the fabric of fiction taught in schools and institutions of academia today. I use deductive reasoning based on empirical evidence from the perspective that nothing is physically impossible unless it is not within my scope of ability to produce after exhausting all avenues at my disposal. Since I had no preconceived notion that what I was attempting to do was impossible according to someone else, much of the time I found a way to achieve the objective

Decoding The Hive

creation of gravity, light, time and the god particle

using methods either attempted before or attempted before in a different manner. My results were not products yielded using modern-math equations which have infected and limited modern science through black magicians, but through common sense. As soon as you enter the equation of math into the challenge, suddenly the invention becomes “impossible”, while all the deeper senses inside of you are screaming that it is completely possible, you just haven’t tried hard enough yet.

You can say that since higher education presented itself to me from the position of highly limited expectations using completely fabricated platforms of pre-programmed failure, I dismissed what others had to say about such things from a very early age. By 8th grade I had had enough and abandoned structured education because it had become obvious that I was being trained by infants and children masquerading as teachers. No teacher in the world is more effective than the burning desire inside one’s own self who flatly refuses to take no for an answer. Learning from people who have the reasons all ironed out about how *you can’t do that* is the fastest way to failure and you are better off just jumping now into the closest welfare line and resigning yourself as an also-ran in the book of life. If you simply accept the status-quo as unquestionable dogma, then you were born on your knees for a reason.

RESEARCH

I was utterly shocked at this message from *somewhere*, as I certainly didn’t believe in gods or angels or demons sending me crystal clear messages. I was a maverick scientist and didn’t think that way at all. I was convinced that my subconscious had been figuring out the science in my head as I slept and had given me the answers at the end of the night. My mind had been producing my breakthroughs all along as far as I knew. But this wasn’t a science equation, it was a message. And it came from somewhere. And right there at that moment, I knew that something else much larger than just me was at work and had no idea where to even begin to find the answers. So I began by looking at exactly how time officially existed, and if I could find that out, maybe I could get answers to the bigger question of exactly where this message came from and what in the hell it might mean.

To begin, I considered TIME itself as we know it. Time is the: days of a year, weeks of a month, hours of a day, and then by the minutes in each hour with those being further fractioned into seconds and finally into Plancks. Thus, I would look at calendars and clocks, and where they come from. At the time I had never even heard of Cronus and could have given two shits about fictitious gods or other wives’ tales and myths. That was the paradigm of the blissfully ignorant that needed a god to get through their days.

Chronometers originated as a direct result from the empirical observance of the sun’s movement around earth, depicting X amount of time between sunrise and sunrise. Then weather played into the equation, as January turned into spring, and spring summer, and summer back into the cold of winter again. There was evidence all around me that there were *definitely* reasons to believe that time exists, but there was nothing indicating where time *came* from. As in, who *authored* it and *how*. This now became for me the same glaring question that those wind-up metal toys had been when I was young. If that metal duck waddled and quacked only *after* I turned the winding

Decoding The Hive

creation of gravity, light, time and the god particle

key on the side, then there was something going on INSIDE that duck that people weren't *telling* me about and much deeper investigation was now absolutely *mandatory*.

The next step then would be to look at the math explaining how the chronograph depicts the link between those sunrises to establish a point of reference to the mathematics itself. According to this vision, there was *something wrong* here, fundamentally, about how time wasn't genuinely an organic phenomenon, and I had to find out what that was, if for no other reason than to prove to myself that I had imagined the entire thing and the world around me was very much "real" and just fine as it was.

CLOCKS DON'T ACTUALLY KEEP TIME

In all cases, it did appear to look like that the ticks of a clock, which work out to indicate exactly 86,400 clicks per 24 hours, is a reasonable explanation of how to *get from here to there* speaking from an empirical standpoint of observation from the constant and inevitable rising sun to rising sun.

MATH: "60 secs x 60 mins x 24 hrs = "one day"

The only problem with the equation above is the fact that there are not 24 hours in any one day. Yet every chronograph on earth is set to those same 24 hours. But *why?* WHY would our clocks and watches be set to a mathematical TIMESPAN that wasn't precisely set to the length of a sunrise to the next sunrise unless something *else* was going on other than keeping time?

But that's just it, time IS a lie for want of a better word, because time itself is a construct. The only reason we even sense time is because there has been great effort placed into the creation of what is called timespace, explained later in this paper. Without time or a way to sense time, the illusion of manifesting would dissolve. But I'm getting ahead of myself.

This section gets a bit tedious, however, I take the *time* to show you anyway, because it happens to be an unknown fact that your seconds are not actually seconds, and your minutes are not actually minutes. Of course that means your hours are not actually 60 minutes and your days aren't actually 24 hours. According to the atomic clock folks in charge of each moment of the day so that the stock market, banks and trains can run on time, there are exactly 86,164.1 seconds in one day, but the problem is, 60x60x24 does not add up to 86,164.1. It actually adds up to 86,400, leaving a difference of 235.9 seconds less than 24 hours. That's right, ***there has never been more than 23.9 hours in any one of your days.*** In fact, each have been 3.93166666667 minutes shy of one day, and each calendar change has been 1.25 FULL DAYS shy of a year. Here is what it looks like on paper:

- 86,164.1 ***actual*** seconds in a day divided by 60 minutes = 1,436.06833333 ***actual*** minutes in a day (***this is an infinity number***)
- 1,436.06833333 ***actual*** minutes divided by 24 hours = 59.8361805554 ***actual*** minutes in an hour (***this came from an infinity number***)

Decoding The Hive

creation of gravity, light, time and the god particle

- $1,435.068333333$ *actual* minutes divided by 60 minutes per hour = 23.9344722222 *actual* hours per day (*this also came from an infinity number*)
- $1,435.068333333$ *actual* minutes in a day x 365.25 days per year = $524,158.708749$ *actual* minutes in a year (*also calculated from an infinity number that was never revealed in the beginning equation, resulting in a fallacy or “irrational number”*)
- $524,158.708749$ *actual* minutes in a year divided by your clock’s *stated* 1440 mins in a 24 hour day = 363.999103298 *actual* 24-hour days per year (*notice this result, after the “point” or “period” began with THREE 9s*)

Pay attention to the numbers above and try to look through the surface of the fact they are all just numbers, and really look. There aren’t 86,400 seconds in a day as your clock claims. In fact, there are only 86,164 seconds in a day with fractions of seconds tossed in for good measure. And while that might not shock anyone, we are using a system deliberately off by .3%, plus we are not even given a real number to even start with as *1 day*. And what do I mean “real”? Numbers are numbers, right? Wrong. Some numbers are numbers and some numbers aren’t, because there are *real numbers* and there are *irrational numbers* in math.say what? Did I really just type that or did I totally misunderstand the test?

If there are let’s say *24 cat naps* per day between sunset to sunset, then why on god’s green earth are we breaking those 24 segments down to 86,164.1 fractions instead of say 86,400 (like the clocks CLAIM to do) which would be able to yield 60 fractions (minutes) within each, made up of 60 fractions (seconds) per minute? I’ll tell you why, because time is being massaged in such a way as to give you the illusion that it is one thing while it is in reality a completely different thing. Man can make watches click once during the time it takes to speak *one thousand* just as easily as he can make it click once while saying *one-one thousand* to indicate what length of time a second is. We aren’t off by .3% because we don’t know HOW to keep time, we are off by that precise amount of time because it is the SYSTEM of the **360 Degree Enslavement Program**. Clocks are NOT so you can tell time, they are Chimera Reality geometric command stations, casting into the aether what time it is behind the looking glass. MUCH more on that later.

By the time we are done with this disclosure series, I promise to challenge your every fundamental truth you have held dear since birth. And here is a perfect example where you learn that we use both *real* numbers as well as *fake* numbers. And we do this on purpose, willingly. Irrational numbers in a mathematical equation can be thought of in the same way as car parts being used as filler in a fresh-baked country pie. What in the HELL are nuts and bolts doing in the apple cobbler?

Yet there they are front and center for all of us to continue to embrace year after year, decade after century we keep applying the same ingredients to our numerical equations, yielding numbers that lead off into infinity. And we just spit out the bolts that get caught in our teeth as if math can just “sort of work” and everything is fine. And why? Because we have been given math and told “*this works, you are just not using it right*”, so we place the blame on our incompetent heads and bend back down to pick some more cotton for massah. Yet millions of mathematicians *per day* run into the same problem where an equation simply will not function to yield a real answer. This is fine when you are adding up your gas bill and phone bill and there is a dangling

Decoding The Hive

creation of gravity, light, time and the god particle

penny you can't account for, but it is not okay when you are dealing with particle physics that deal with trillions of Plancks per second that each one needs to be accounted for or you might accidentally vaporize the planet.

Fractional Trading is one area where this has been used to fleece the public, but while that is just an extreme example of how **Numerology** is actually black magic casting spells into your world, it is being applied to your life every *second* of every day. *Seconds* being PURELY FICTIONAL, since the TIME you are being handed is not real time, it is being artificially fabricated within this Chimera Reality and pawned off as your life. I will show you exactly how time is actually created later in this paper, and how that is the platform by which manifestation is achieved. I would never expect you to just get this at the very start of this disclosure, because time has always been the one true constant in your reality field. I will have to break this down into sub-quantum terms in order to show you that the foundation of your existence has been counterfeit since long before you were born into this latest life cycle.

MATH DOESN'T ACTUALLY WORK

Once you take the seconds in a day shown above and you break that up into minutes, the result is 1,436.06833333. Those final 5 digits in Vortex Math (advanced math) simply do not exist, because they are **broken**, and will **never** resolve. The 3s will run off into the next star system if the calculator had enough positions to show the fractions. And what is that? To make this simpler to understand, let's put this into everyday terms we can follow.

You have 10 apples and you sell Bob, Jim and Debbie each equal portions from your apple cart. Each one gets 3 apples, and there is one left over. Either Bob, Jim and Debbie will need to each take 3 bites of that last apple, or there is a problem. The way we might deal with this in real life is to simply cut the final apple into 3rds and then go back to picking more apples. But since numbers are not as forgiving as Bob and Debbie are, we must resolve back down to a zero (an empty apple cart), or someone is getting screwed. Using broken math, there is no way to resolve this because there is no such thing as a third of something. There are halves, there are quarters, but there is no third. At least within our numerical system. And that is because our numerical system is based on a "vampirical" structure called **Weasadox Phantom Scalar Mathematics (Mathemagics)**.

This is just a surface explanation to this major issue, and I will be introducing you to Vortex Math later in my reports where it is simply a fact that there are **phantom** numbers used in today's mathematics; 3, 6 and 9. These numbers will not resolve, and therefore are *thrown out* of computations. If you haven't heard of this before, then this will be a new territory for you to learn about. But I am certainly not going to stop there with the announcement that *math is broken because numbers don't work*, I will be showing you WHY math is broken because numbers aren't actually numbers, they are *spells*. The Vortex Math section will not be included in this first volume, simply because we have far too much to cover before we get to that, because the very foundation of our equations and our language is utterly artificial. The reason mathematicians aren't able to use our numbers to arrive at accurate results is not because scientists are stupid, it's because they are using a system that was designed deliberately not to work.

Decoding The Hive

creation of gravity, light, time and the god particle

If the numbers we use were authentic, then there would be such a thing as a number when multiplied by itself, would render 2 and it wouldn't be called "addition", it would be called multiplication. Don't ask me, ask Mathematic Science if this is true or not. You will find out that unless math is universally divisible, then it is not math at all, it is gibberish, just like your spoken language was turned into babble eons ago by "*the gods*". That's right, even your own BIBLE tells you it was not only on purpose, but it wasn't *just one guy* who made this decision: apparently it was a *whole bunch* of jackasses who AGREED to hammer humanity with confusion; "*Come, let us go down and confuse their language so they will not understand each other.*"

Our language, whether written or spoken, is not just a method of communication; it is numerical and mathematical in every possible sense. And has been, in fact, ciphered into our world. It is used for the masses as one thing, and then used by the ruling elite as a code that allows our minds to be commandeered through every form we apply it. And because our language is a cipher that is meant to disconnect us from the truth, the numbers behind the letters were designed broken from the very beginning. Our **grapheme** letters came from ancient **symbols**. Behind the symbols are **numbers**. Behind the numbers are **command codes** which are each linked to different **talismans**, *not* mathematical results. That's why our numerical system doesn't work and why our language literally casts spells with every single word we speak, write or even hear in our head silently. I will be showing you how these codes are written, what they look like and what they do. This is not a conspiracy theory. For now, let's cover the foundation of the system.

All communication is based on value.

What does "*five guys down there*" indicate? What does "*three teaspoons of sugar*" mean"? There is no such thing as communication without value. Even the simple reference to the day itself is numerically-based: "*Nice weather we're having today*" (now, this moment, numerically 1). "*My cat is fussy*" means that 1 cat. "*Call me tomorrow*" means 2; when you are supposed to hear from Mary, not today which is 1. In fact it is impossible to form a single sentence that is complete in its construction without indicating value, because it will need to convey a message that cannot be verbalized without indicating the numerical value of that which you are trying to express. "S" stands for "*more than one*" as in: "dog"=1, "dogs"=2 or more. But S does not indicate THREE dogs or FOUR dogs, so the best we have to work with is "*something more than 1*" since the gods decided to turn us into babbling idiots. And that is why we are now using *fractions*. Fractions aren't numbers, they are an illusion that we think exist because we were told they exist. But there isn't such a thing as a family with 2.3 kids and as long as we think there could be, we will keep pounding nuts and bolts into our calculators, expecting eventually we will finally get a cherry pie.

Our numbers indicate *value*, but our words indicate *value* equally and at all times; this is why the cipher was possible, because the fictional mathematical symbols and values assigned to them made it possible to create an alphabet that could be written using either system but appear as two different things. "*A pregnant woman*" means 1 woman and "*a pregnant woman carrying her husband's baby*" means 1 woman married to HER husband, meaning 1 man. It was not words

Decoding The Hive

creation of gravity, light, time and the god particle

that were scrambled at the **Babble-On Massacre** event at the **Tower of Nimrod** in Sumer-Ur Babylon, it was communication, including math.

*We were handed letters and numbers and never asked where they came from. We did not develop them ourselves; we blindly used what we were taught. Each time we use those forms of communication, we are agreeing to the terms and conditions of the game. But since we never asked what those terms were, we now suffer the consequences. You will see this coming up later in the disclosure, where when you pick up the dice in **Jumanji** and you roll, you just signed an agreement with **adhesion contracts** attached to it that you didn't know about, and you are then officially "in the game". **Common Law (Interdimensional Sovereign Law)** doesn't work this way, but **Maritime Admiralty Law** certainly does. The fake Maritime Laws that now govern us were made for ocean travel, not land. By the end of this volume you will know more about the water at the bottom of that ocean than over 99% of the population alive, and you will see exactly why it is **Maritime Law and Maritime Language, Math and Science** is what controls mankind today. All of those laws, rules and procedures speak to the aether and the power of **water** was behind all of it all along.*

Our "time" is being reported to us using numbers we think are fully functional, so we have no way to detect that time itself is being manipulated by powers who have their own secret and fully functional math in order to author a broken system for us that can be relied on to keep lying to us into eternity as long as we continue to use symbols that carry invisible codes that yield *almost acceptable lies*. Why is it that our mathematicians accept this? Because they are given no option. Here is what *Mathematical Science* has to say about math:

Wiki: **Mathematical Science**;

"Mathematical Sciences is a group of areas of study that includes, in addition to mathematics, those academic disciplines that are primarily mathematical in nature but may not be universally considered subfields of mathematics proper."

In other words, Mathematical Science **dismisses math** in its current form as unable to address science in other platforms where there is a need to quantify data in real terms. In other, *OTHER* words, math does not work, and science is fully aware of this. In your mind, math and science are the "same thing", but that is far from the truth. They are two completely different things being wrapped up in the same glittering bow. Science is observation, and math is what explains science. Because **math is a fabricated lie** and *refuses* to delineate science into functional equations, math and science secretly hate each other's guts. And for good reason.

In fact, quantum science has long since dismissed math as (and I quote), a "quantum time loop". WHAT? How would quantum science come to the conclusion that math is a construct that is connected to **TIME** and leads into an "infinite loop"? Because math is exactly that, a broken system designed to manipulate the spacetime fabric of our existence, and science *knows* about it. Of course no one has an answer as to how to get out of that loop, but when **real** numbers are applied to **real** physics, math is shown **on its face** as unable to put into numerical terms what is being observed by the human eye. And most of the time, egregiously so. This is why scientists

Decoding The Hive

creation of gravity, light, time and the god particle

are forced at the outset to lie through their teeth before ever being handed any grant money. Either they are in support of the **disinformation industry** that is **education** and scientific advancement, or they can kiss that federal funding goodbye. If you are a scientist now reading this, then you know exactly what I mean and you cannot deny it.

The numbers 3, 6 and 9 just so happen to be “*the secrets to the universe*” as Tesla is often quoted as saying. Not because they are NUMBERS, but because they are SPELLS. And I am going to show you exactly how they have been used to code the words (numerology) that you use later. 3 is the symbol for the broken numerical system that was supposed to be used in this dimension and has been used to indicate **god** in so many places it will take your breath away once you see it. 6 is the multiplication of **the gods**, also used across the spectrum inside your *letters*. 9 stands for the **complete group of gods** who collaborated in this insidious scheme and when you see this one, the *throw away* number, and how utterly saturated your communication has become with it, you will be left speechless. At least I was. Let’s put it this way, you are unable to speak without casting the **Babylon Spell** into your communication without it, ever. And guess what? All those numbers are considered **irrational** to Mathematic Science. I won’t just be telling you about this corruption, I will be giving you examples held in all forms of communication used since that day in Babylon that were even *chiseled into stone* so you never forget to use them.

CALENDARS DON’T ACTUALLY WORK

Timeanddate dot com *casually* explains that “*since the calendar is not 100% accurate, it is necessary to insert 1 day every 4 years in order to keep it synchronized*”. And according to their math of 365.25 days per year needing to be accounted for by 365-day-per-year calendars, 1 additional day placed at the end of February every 4 years would indeed make sense. The problem with that is, there are **less** than **364** days, not less than **365** days. Just reading that one time may not actually do the job, because as Zack would say, it is so *ridiculously* ridiculous. And yet it happens to be true.

Here is the actual math:

- 525,960 **claimed** minutes = **365.25 claimed** days per year
- 524,158.708749 **actual** minutes = **363.999103298 actual** days per year
 - Difference = <1.250896702> **less** days than claimed, **per year**
- 365.25 **claimed** days per year x 4 years = 2,103,840 minutes
- **Actual** minutes per year x 4 years = 2,096,634.835 minutes
- **Claimed** Minutes per 4 years minus **actual** minutes in 4 years = <7,205.165004> **less** minutes
 - Difference = <5.00358680833> **less** days than claimed

So in real terms, there are actually over 5 less days in 4 years than the **clock AND THE CALENDAR BOTH** claim. And this obviously isn’t a theory, since the math is right there and anyone can cross-check it with a calculator. If the days on your calendars are stating that there

Decoding The Hive

creation of gravity, light, time and the god particle

were supposed to have been more minutes than what you experienced, who would bother to notice? The message is not that we are still using time-keeping systems that were invented in a cave somewhere, the real question it brings up is where is that time going, because it hasn't been accounted for since a *Catholic Priest* (you heard me) instituted the Gregorian calendar in October of 1582. Like the million other clues purposely left behind by earth's overlords, you were supposed to have noticed this by now and if you didn't, you would not be able to claim later that no one ever mentioned it. It was *your choice* to continue using a system that was outlandishly broken.

But here's the slight-of-hand: The claim is "*1 day is missing every four years and must be added back to make the calendar balance to the clocks*". And since it looks like a mess to someone casually observing, we dismiss it. But the problem is that more than 5 are missing and because they DID something to "correct the issue", then you assume that the issue was in fact resolved when it absolutely **was not**. It was merely given a bubble bath and a pink bow.

More than this, the Luciferian Brotherhood hold this up as the example of what they are doing as a good thing, because they are keeping idiots from moving up higher and back into the Deity Planes, *so they are literally providing a service* for the interdimensional communities. And no, I am absolutely not joking. This goes for every single service-to-self trap they catch you in, be it self-destructive sex, hallucinogenic drugs, disfiguring your temple (Avatar) with piercings or tattoos, or any other unauthentic, self-destructive act. If you think I am making this up, just contact the Illuminati and ask them how they justify all the corrupt, horrible things they perpetrate on mankind and they will tell you in their own words. And no, the Illuminati isn't a fictional fraternity anymore than Pep Boys or Burgerking. Visit their site this very minute if you don't believe me, you already know the address.

So we go about our lives thinking that we are "sort of accurate" about things and as a whole, we are doing okay. This is NOT true. 1 day per year goes unaccounted for, yet magically the first day of the year never ends up in July because somehow it works so we flatly ignore the fact that the numbers positively and for a matter of fact *do not add up*. Such clues left by your captors are actually part of the program which has to do with the aether and the **command codes** that create this artificial reality we will get far deeper into as we go. We don't pick up on them, which reinforces their argument that we have *no business* going anywhere which can be proven in a few seconds before an educated ruling council at no more than a casual glance because it was so overtly obvious all along.

THEORY OF RELATIVITY DOESN'T ACTUALLY WORK

If the MATH being used to calculate time is so dynamically incorrect as to literally *lose without trace* 1 full day every year, then maybe we need to look at the theory behind the longest measurement (or shortest, depending on how you look at it) is determined. My next obvious stop would have to be the **Theory of Relativity**, because it is supposed to establish exactly how time is measured in space. We have already shown that the MATH behind our EARTH time is not just wrong, but egregiously so. Perhaps those who are supposed to be flying around in outer space will be able to tell us how it is they are managing to keep in perfect synchronization with

Decoding The Hive

creation of gravity, light, time and the god particle

earth while putting in the coordinates that allow them to navigate the immeasurable expanse of space without being obliterated by a head-on collision, seeing as their watches are .3% wrong (which is absolutely perfectly fine while traveling *nine times* faster than a speeding bullet). And before someone pops up and claims that the space shuttle doesn't fly faster than a bullet, then I will interject this:

Rhett Herman, physics professor, Radford University:

*".....earth is moving about our sun in a very nearly circular orbit. It covers this route at a speed of nearly 30 kilometers per second, or **67,000 miles per hour**. In addition, our solar system--Earth and all--whirls around the center of our galaxy at some 220 kilometers per second, or **490,000 miles per hour**."*

This means that earth is "spinning" and also "traveling" at a combined speed of *557,000 miles an hour* according to the "experts" and the shuttle is able to just wander right out there outside of earth atmosphere, check things out and then wander right back in again. Which is a neat trick, since the space shuttle is designed to travel at 18,000 miles an hour, or roughly **3000% slower than earth:**

Spaceflight.nasa dot gov:

*"To achieve orbit, the shuttle must accelerate from zero to a speed of almost 28,968 kilometers per hour (**18,000 miles per hour**), a speed **nine times as fast as the average rifle bullet**."*

Since this topic will be discussed at length in the chapter BEYOND THE MEMBRANE (in a later volume), I will just leave this right here with you pondering how it is that the space shuttle is able to find its way back to Cape Canaveral if it is being left behind by earth at the rate of 12,936,000 (12.9 million miles) *each day* it is in space. Incredibly, **Space Shuttle Endeavor** managed to make up a lost **116 million miles separation** from earth after its historic 9 days poking around in space and even docking with the **International Space Station** that was also being left behind at almost 13 million miles each day, and glided effortlessly onto the tarmac at Kennedy Space Center on the 20th of January, 1996. This difference between the shuttle and earth's claimed velocity in a 9 day period is the equivalent of traveling to the moon and back **8,582 round-trip times**.

I am absolutely sure that .3% miscalculation from their deliberately miss-timed watches would have zero impact on a 116 million-mile mission when time-vector coordinates are all they have to go by. Actually, since the space-station has been actively in space for 31 consecutive years now, that would have given the astronauts plenty of time to have installed a huge array of highway markers, making navigation much easier by now. It also means that it has been separated from earth by **145 quadrillion, 963 trillion, 500 billion miles** so far; at least if it has been moving at the same speed the shuttle is able to travel. And of course, the shuttle made it there and back on top of falling behind an additional 116 million miles, even though they were both **traveling at the same speed**. How preposterous does the lie have to be before we pay attention to what they are actually saying?

Decoding The Hive

creation of gravity, light, time and the god particle

SPOOKY ACTION AT A DISTANCE

Einstein had the “answer” to extreme rates of measurement some years back, that the speed by which light travels is the “fastest” known naturally-moving object. Therefore, he used the *speed of light* to establish how FAR it is *from here to there* when speaking about the furthest distance we know of, that of space. Surely THIS will be more accurate than the monkeys with home-made watches are here on earth.

As I mentioned before, today’s science (empirical observation) has been “explained” by the lie of the mathemagicians. By using math (equation), they can *explain* what it is you are observing. And if that math were based on a lie, then the time you experience would also be based on a lie. And what do you know, math, the way we have been taught, is just that; an unbelievably well-constructed lie.

How do I know? Because math is based on the numerical explanation of what you see or perceive. The problem is, what you see isn’t actually real. It is a careful slight of hands by using **spacetime dilation** which is in fact a holographic construction of photons (light waves) which carry the energy needed to power senses in the mind that emulate material existence. If you slow down the processor, you can slow the car down the same amount and there is literally no perceived difference. If your foundation to math is not factually based, then the entire skyscraper, depending on the height you build it, will eventually fall. Sure, you can make one “10” or “100” stories high that will stand using *flawed* math, but beyond that it *will* collapse, keeping man stationed right here on earth and NOT in space.

To make a long story short, the **Theory of Relativity** is based on the speed of light “within a vacuum”. If inside of an atmosphere where there are no disruptions, then *light speed* is presumed to be a constant. Light, when it passes through our air at say, “5 feet off the ground”, travels one speed. When you elevate your light beam to 100 feet, the air is much thinner, and therefore it travels faster due to the lack of particulates slowing it down. The same holds true when your light beam tries to travel through a cloud, or through water, the speed changes. To make his theory “sound”, Einstein made up the PURELY fictional notion that you would be able to measure the speed of light inside of a chamber called a vacuum where all air and all other particulates had been sucked out, leaving nothing but “empty space” inside. Thus, whatever seconds (we already know how accurate “seconds are”) it took to travel 1 foot would be exactly 1/10th of the time it would be to travel 10 feet. Of course this isn’t true, because there is no such thing as a vacuum. No scientist who has ever lived has proven such a theory. However, thousands have proven there is no such thing as any area utterly void of any content. Quantum science has gone on to show that every square centimeter of area is absolutely cram-packed full of *other things* once placed under their electron scanning microscopes. We will get into those *other things* coming up.

You need to establish what “mass” is before you can “measure” anything. Because the human eye can SEE an “inch” or a “centimeter”, then it can be used as a measurement of solid “mass” to the casual observer. A foot of distance is 12 inches. Basic math right? 10 feet is 10x further than

Decoding The Hive

creation of gravity, light, time and the god particle

1 foot. Also basic math. And, in fundamental applications, this is a constant. Meaning that it does NOT fluctuate, allowing us to establish the method by which you can measure how long it would take *at this speed* to get from *here to there*. It can be replicated on any paved road from mountain peaks to desert floors by using a rigid measuring stick, timing the duration by which *500 feet per minute* might be. On earth, 12 inches is 12 inches and 1 foot is 1 foot. The math seems to work on this fundamental level. However, when setting the standard for *mass* and then positing to measure the distance between earth and the stars, or to establish how gravity must be created, you must have some sort of material fact to base it on.

Measurement is the foundation of math. You must first establish a point of reference in order to generate a reproducible result as compared to something else, allowing you to actually generate an equation. This means that math MUST be established at its QUANTUM point of reference to even exist in a real-world application *at all*. Math, (based on MATERIAL existence), must be made out of matter, otherwise you cannot establish the mass of the object.

In this case, Einstein's measuring stick of the *speed of light* is made out of rubber. The progression of light (photon particles) slows down when traveling through water or speeds up when traveling through clear desert air. In fact, light even moves slower 5 feet off the ground on the beach compared to 5 feet off the ground inland. It also speeds up when you raise your flashlight 10 feet higher from that. There is no constant that can be established in atmosphere even here on earth, much less in a part of our world we had not yet been, therefore the speed of light is an erroneous postulation to even begin with. Einstein's Theory of Relativity was written in 1905, **56 years** before anyone had ever even been in space, meaning all the assumptions behind the theory related to anything beyond the clouds were based on guessology from observation at an extreme distance. Let's make this clear right now, that air IS water, just much thinner than what is lying in a river bed. The particles inside of a vacuum are just as variable, since there is no way to dictate which types of particles remain inside the vacuum after "the air" has been sucked out, because the air is simply replaced with thinner matter that still carries innumerable variables in its volume. *All* of which is called air.

To measure SPEED or DISTANCE using a non-material, fluctuating measuring stick is like using the flavor of fried onions to explain the Zodiac to a blind man.

At the core of the smallest energy particle ever observed under the most powerful quantum microscopes ever created, there has never been discovered a single speck of mass. **EVER**. This is not a secret. Every 5th grade science teacher who is even semi-conscious knows that the only thing ever found at the core of any atomic particle, no matter how small, are light waves. Planets are made of light waves, people are made of light waves and sand particles are made of light waves. On top of this, it has never been demonstrated that one normal rock that was larger than another normal rock attracted the other closer as if it were a magnet and the smaller one were metal.

EVER.

"Mass" cannot be measured physically, it does not cause gravity, and mass also cannot be used in the measurement of "distance", because there is no such thing AS "mass".

Decoding The Hive

creation of gravity, light, time and the god particle

*There is only electrical current flowing from one aether particle to the next that has been quantum-entangled through thought, which creates gravity through its own atmosphere particles that display a color that is coded to a **gravitational signature**.*

Planets with an atmosphere have gravity, and LARGER planets have MORE gravity, but it was never the planet that was creating gravitational “pull” because of its “mass”, it was a particulate ELEMENT in the atmosphere within its FIELD creating gravitational *push*, triggered by invisible light waves which are actually sound waves. Larger planets have *more* atmosphere than smaller ones do, so they carry more gravity. What is *in* “atmosphere” is what creates gravity which you are about to learn more about than quantum science knows.

MICHELSON-MORLEY EXPERIMENT

Now we have an entire world filled with highly advanced mathematics based on this completely flawed foundation that light speed can be considered a constant, depending on the humidity of the air. As explained, it isn't “constant” in water, it isn't “constant” in air, and it isn't “constant” in even the most passionately created “vacuum” because particulates differ in molecular density throughout the aether, even in space. *Always*, because light itself is an elemental particle (called a photon) that carries its own signature. Aether has always been on the front-lines of attack since the first UNIVERSity opened its doors to teach **ciphered Hermetic Alchemy**. If there is such a thing as aether, then there has to be such a thing as “god” or some other driving force behind creation other than green slime bursting out of nothingness and into billions of perfectly functioning living organisms, as if life is so basic in design, that given enough time and enough bags of kitchen trash, monkeys would be able to grow their own creations inside their watering buckets.

*Wiki: **The Michelson–Morley experiment**;*

*The Michelson–Morley experiment was performed over the spring and summer of 1887 by Albert A. Michelson and Edward W. Morley at what is now Case Western Reserve University in Cleveland, Ohio, and published in November of the same year. It compared the speed of light in perpendicular directions, in an attempt to detect the relative motion of matter through the stationary luminiferous aether ("aether wind"). The result was negative, in that the expected difference between the speed of light in the direction of movement through the presumed aether, and the speed at right angles, was found not to exist; this result is generally considered to be the first strong evidence against the then-prevalent aether theory [which said aether doesn't exist, that particles are functioning strictly off of coincidence with no higher thought-form behind them], and initiated a line of research that eventually led to special relativity, which rules out a stationary aether. The experiment has been referred to as "the **moving-off point** for the theoretical aspects of the Second Scientific Revolution".*

In other words, aether does in fact exist because there is no such thing as something at the quantum level that is stationary. Light does not travel at fixed speed, and the Theory of Relativity

Decoding The Hive

creation of gravity, light, time and the god particle

is fundamentally and factually inaccurate. Today it is well known across scientific fields that these are truths, but for some reason, now more than 100 years later, you still haven't heard of it. In fact, the utterly corrupt academic world is no less for the wear as such monumental experiments prove beyond any doubt that accepted science is based on fallacy. They simply don't bother to mention it in the classroom, and viola', problem solved. Apparently it takes millions of little acts-of-god, sending private messages to self-styled physicists such as myself, to prompt us all one-by-one to learn the truth and then scream it from apple crates on street corners, otherwise humanity would be destined to continue to worship the omnipotent sun god seated on the throne of math, marking the date with their broken calendars using their broken watches to set the hour so you will never know anything about the celestial bodies and their alignments that regulate your electronic field that regulates your entire perspective on reality. Anunnaki numbers are designed to loop and the field surrounding you is designed to keep you from ever seeing how they do that both to your equations (as in fractions), and to your physical view before your eyes that are generated exclusively by electromagnetic energy.

Later, when the Theory of Relativity began to break down when challenged by even greater applications, Einstein came out with the **Theory of SPECIAL Relativity** to explain the exception, as mentioned in Wikipedia. THEN, when the Theory of SPECIAL Relativity failed, it reverted AGAIN, this time, back to **Newtonian Law**, the previous and archaic *answer* to gravity and math in general. Neither of Einstein's Theories answers the question of what it is you are observing with your eyes and that is EXACTLY why Einstein constantly reminded everyone that his were *theories*, not laws. Both *Relativity* and *Special Relativity* are theories based on intensely minimal understanding of the fluid dynamics of 3rd Dimensional physics only, and have nothing to do with what is outside of this atmosphere, so they could never answer WHY gravity actually exists or how it is created, much less how far it is from Mars to Venus. Newton's "Law" is merely observation without solid mathematical explanation to explain the effect, other than offering that what goes up seems to come down. This is not a scientific explanation; it is simply stating a fact. Science is supposed to explain why things function as they do. But since science is now based on theosophy, not actual empirical proof, his analysis stands today as if it were fact just as much as an apple falling from a tree can hit you on the head if you are standing under its branches. Using mathemagics he was able to spin a yarn and the world bought it.

*It is fair to note here, that while I had been refuting what "authorities" had been proffering as fact, it turns out as well that the quantum society had been doing exactly the same thing, rejecting what notable college professors had to say because they knew the math was not adding up. If they hadn't, then they would never have cracked the case of the **Double Slit Experiment** and proven that what Einstein called "spooky action at a distance" had been true science all along. Today it is well known throughout the scientific communities that the Theory of Relativity is nothing more than an antiquated, archaic postulation. By the end of this report you will see that it was no more accurate than the **fiction** of Newtonian Law.*

SPATIAL RELATIVITY

Decoding The Hive

creation of gravity, light, time and the god particle

After proving that our time had been a construct of false postulations by accredited celebrities and not actually based on true facts regarding accurate delineation of observable solar duration, it was time to bring my findings to the public. After all, I had just formulated my own theory on how gravity, light, heat, time, and life had to be created if both Newton and Einstein were wrong. And I was more than certain that they were. I would initially call it the Theory of Spatial Relativity. Later I would realize this was actually the *interdimensional laws of physics*.

CHAPTER 2

CLOSE ENCOUNTERS OF THE 1st KIND



CONTACT

My first post on my blog on the subject of **The Law of Interdimensional Relativity** carried the principles that will be covered here, without the vast amount of additional details that have been explained to me since that time 4 years ago. Once it had been reviewed by a representative of the Interdimensional Association of Free Worlds, I had my first *contact* with beings from outside of this dimension and my life changed as radically as if I had relocated to Mars. First I was informed that my theory was correct, and then I was asked *how I knew this*.

Decoding The Hive

creation of gravity, light, time and the god particle

My very first response to this being who I was now speaking to on the phone after exchanging numbers via email, was how do *you* know that my theory is correct? I mean its not like everyone sits around and ponders at length the nature of sub-atomic particles and even if they do, there is the little matter of proving how they go about interacting with life. Her answer was direct and to the point; *“I am a multidimensional being who reports off-planet on a regular basis regarding the evolution of the children of earth”*. (Later she indicated that the “second sun” -shown in the photo above- that began parking next to ours in 2012 was where she reported almost on a weekly basis. While it does glow like a sun, it is really a biocraft. A craft she has more than once gushed about openly on how magnificent it is to experience in real life.)

Being that I was at the time an egocentric, multi-patented, self-educated inventor and physicist, my immediate response was she was insane and asked her to prove it. That’s when the education began. Over the next few hours I was forced to come to the understanding that this person had a greater knowledge base than anyone I had ever known, and by a *very long* distance. I would ask a question and hear a subtle deep breath on the other end of the line, followed by a 45-minute lecture of exactly where the study had been performed, what the names of the scientists involved were, the date of the study, the name of the laboratory and every full scientific and medical term associated with the experiment without a single hesitation or word sourcing. During the disclosure, it was like speaking to a sentient computer with a female accent.

Over the course of the next 3-4 months, I would spend upwards of 10 hours a day on the phone, learning about every detail of the most insidious conspiracies perpetrated against mankind I thought could ever exist, and with each one, my emotional security would hit a brand-new low. I had never considered any such stories as anything more than paranoid delusions held by schizophrenic sociopaths who were under the impression that the whole world was out to get them. But each time I would be given a new subject, along with clues as to how to truly vet the story, I was simply unable to disprove a single one of them. And since I approached each one with absolute confidence that it was totally fabricated paranoia, I was never looking to prove the theory correct, only to disprove it. After all, I was now fighting for my life; because if she were right, then that meant that I actually didn’t know anything in true reality as I wouldn’t even know what true reality was. One “theory” turned into 10, eventually turning into dozens and dozens and I would spend hundreds and hundreds of hours online researching the deepest levels of each story, only to come away with such overwhelming evidence that they were fact that I could feel the ground itself crumbling beneath my feet.

After a few weeks, I was a true believer at least in her knowledge. *Not* in her claim.

What I wasn’t a believer in was that she was actually able to move between this world and others, as that ability has never been evidenced in physical terms within this culture. As far as I was concerned, I was talking to someone who had many decades of education behind them regarding conspiracy theories, who also just so happened to have a photographic memory. This means that if she read a college manual 30 years ago one time, she could open the pages of that book in her mind to page 84 and read verbatim the 3rd paragraph (or any other paragraph) at any time.

Decoding The Hive

creation of gravity, light, time and the god particle

INTERDIMENSIONAL LIGHT SHOW

Around October of 2013 I received a phone call from my contact and was told to meet her at a certain city the following day, as she was going to pass along information to me *“that could not be transmitted by any electronic means, as the walls have ears”*. By this time I was well aware of the fact that our lives are monitored by devices in every home and at all times. Especially if your internet habits trigger red flags in the algorithms that track *conspiracy theorists*, of which I had now become one on a level that would rarely have an equal. I had already witnessed my computer freezing up completely on certain websites that carried extremely damning evidence against the Kybal, so I knew that if there was a list, I would already be on it. I would learn later just how much that was true. I packed a bag, jumped in my car and began driving the hundreds of miles between my home and where our meeting would take place with no further questions asked.

I arrived the next day on time, greeted by a middle-aged lady who looked just as human as you or me. That is the extent of how much I can share about her appearance for security reasons. My education continued every minute through that day and evening, and began again the following morning. So far it was the same type of information as before with nothing terribly out of the ordinary. If you call learning how beings with superpowers pull off global mind-control programs using unheard of technologies ordinary.

We had moved from one location to another for our meetings continuously (of course), and our third location overlooked a harbor with a small balcony for taking in the sights. For some reason I had the forethought to snap a couple of photos of it for posterity. Little did I know that I would be using these pictures later in order to illustrate what was about to happen next:

Decoding The Hive

creation of gravity, light, time and the god particle



Later I took another snapshot:

Decoding The Hive

creation of gravity, light, time and the god particle



Around 11 pm that next night we were standing on the balcony overlooking the harbor, still talking while looking at the stars. Without a single word of warning, a fleet of spacecraft appeared before our eyes in the shape of a vector pattern some 1000 feet across the harbor and around 1-200 feet up. It spanned around 150 feet in height and the pure white light crafts had formed an absolutely perfect geometric pattern in the sky so obvious that Stevie Wonder could have seen it. There would be absolutely no way I would have the awareness of mind to have taken a photo of this, as I was speechless, gasping for air and screaming like a little girl, as this defied all known laws of physics. I used one of the images taken earlier in the day to simulate what she and I saw:

Decoding The Hive

creation of gravity, light, time and the god particle

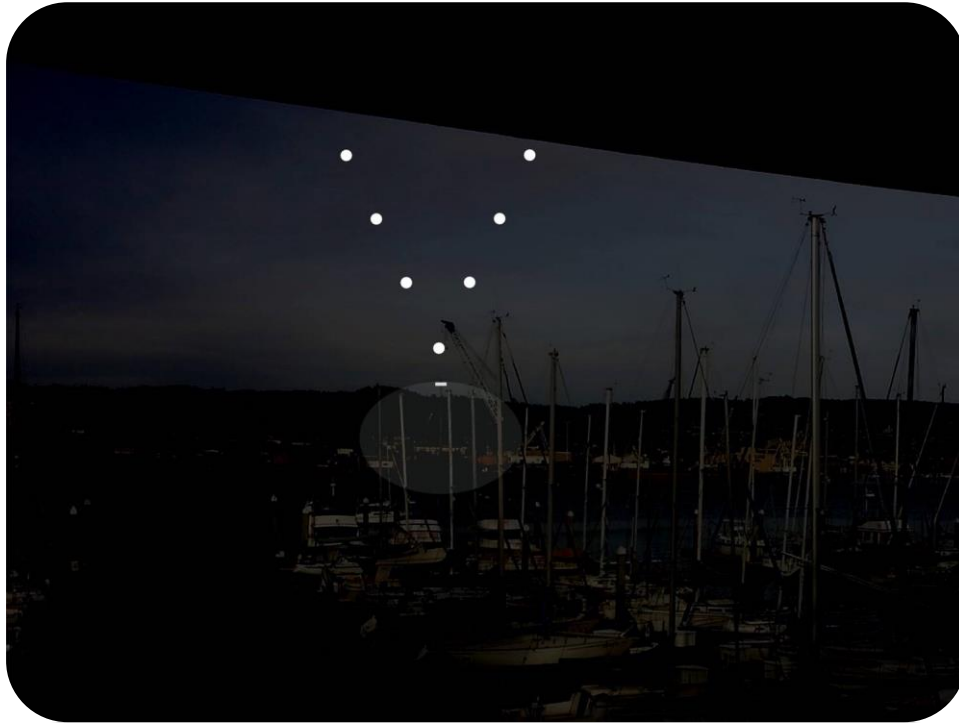

For some reason, the crafts were centered over a small light just on the other side of the harbor. From there, the crafts would switch the pattern roughly every 20 seconds to a completely different formation. They never moved to their new positions, they simply blinked off and at that exact same moment, they would appear instantly in the new pattern:

Decoding The Hive

creation of gravity, light, time and the god particle

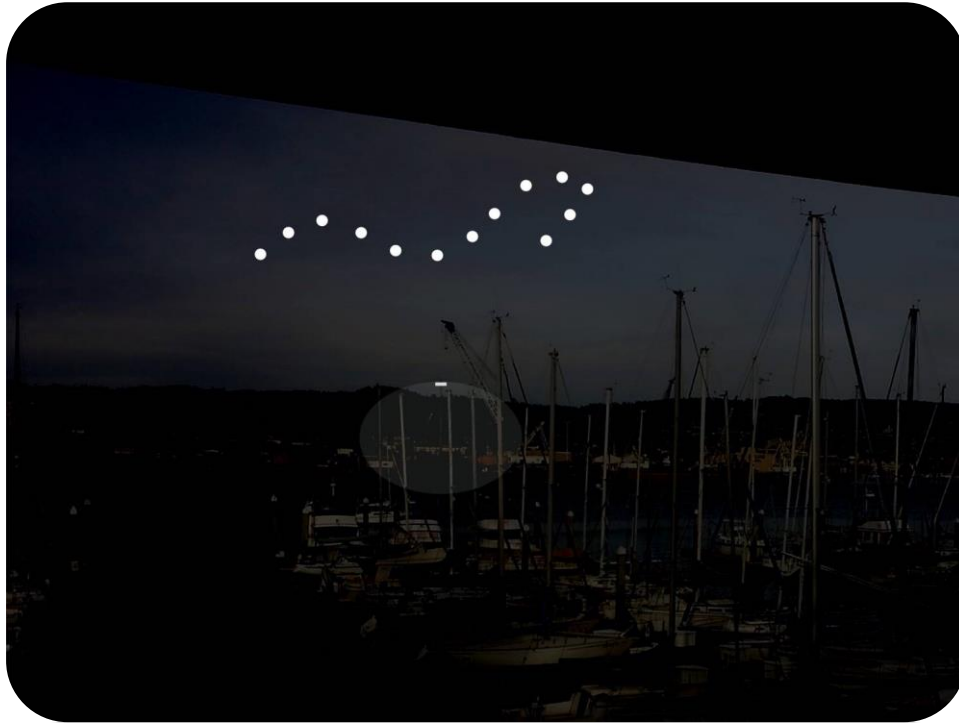

Each pattern was roughly 150 feet in span, regardless of which geometric shape they would take. I went by memory to recreate the patterns, and the only one I am 100% certain of was the vector, or “chevron” shape which did show back up again at different times over the entire span of the “light show”. The other patterns may have had 7 crafts in them, possibly more as this image above illustrates, I can’t be sure. I was literally going out of my mind, but the patterns didn’t take a break:

Decoding The Hive

creation of gravity, light, time and the god particle

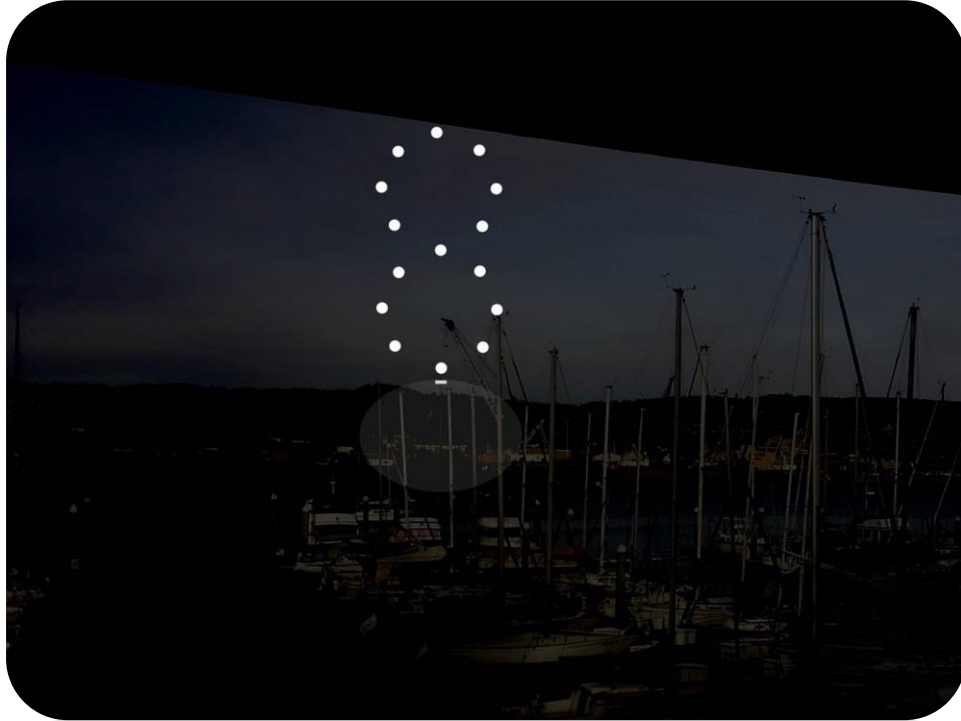

While I was screaming (under my breath) to my contact “*do you see that?*”, “*what is that?*”, “*what is happening*” like a hysterical child, I noticed that the people on the balconies off to our left weren’t seeing them at all. And as you can see from the recreation images, it was a blazing display like being front and center of a private fireworks show. The only people alive who could see this mind-shattering show was her and me:

Decoding The Hive

creation of gravity, light, time and the god particle

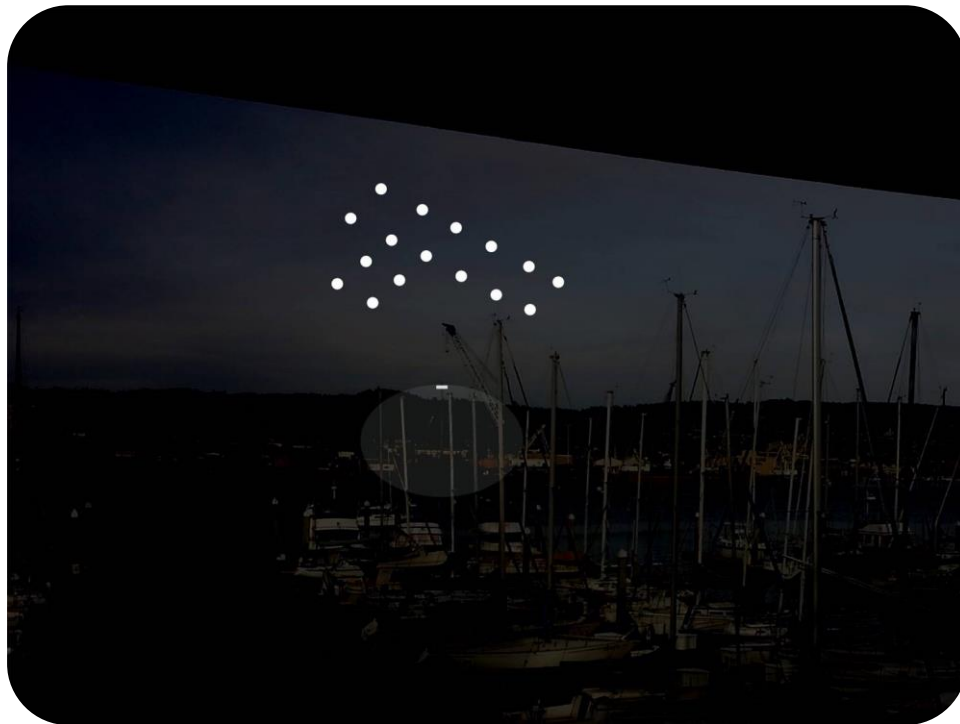

This went on for $3\frac{1}{2}$ hours. We weren't smoking weed and she hadn't slipped me a Mickey. I was just as lucid then as I am now recounting the event. My mind and my image of *the real world* was shattered the instant the first pattern appeared. I can only conclude that I witnessed thousands of space crafts that night, or I witnessed dozens who were able to relocate in less than $1/1000^{\text{th}}$ of a second to new locations in a never-ending display that was meant to rock me down to my core and on no uncertain terms. The illustrations above are somewhat smaller than the actual display, because we were at the rail while this took place and the photos I had taken of the harbor were from inside the room, so in order to illustrate what we were seeing, I had to scale them down somewhat so they would fit in the sky afforded by the pictures.

During the entire duration, I never stopped asking what it was that was happening, but my contact never spoke a single word. It was the most exhausting experience of my life and by the time it was over I could barely stand as if I had run a 20 mile marathon. What followed next was so completely bizarre that I didn't even know how to compartmentalize what it was I was seeing. Later however, it was very clear and I have also been briefed on just what that was.

When the lightshow ended, she turned to me and said "*I'm sorry, I couldn't continue to elevate the frequency of your pineal gland with mine any longer than 14 minutes*". As if I hadn't already seen enough over the course of the entire night. I said that it hadn't been 14 minutes, but actually $3\frac{1}{2}$ hours, what did she mean? She said "*You don't understand, time works differently in higher*

Decoding The Hive

creation of gravity, light, time and the god particle

dimensions than it does here". So apparently the frequency dimension she had enabled me to peer into had been positioned from the 4th or 5th (she never said which dimension we had been visiting), and the time that passed while there was only 14 minutes. Earth time had passed far faster, something I would learn more about just a little later that night).

The next thing she said to me, turning to look at me directly in the eyes, was "*This was necessary because your disbelief of who I am is counterproductive to your education*", or something to that effect. And of course I knew exactly what she meant, because until this moment I was still under the firm belief that people are just people and aliens absolutely do not exist. From that night forward, I would never think those thoughts ever again.

A few years after the lightshow, I was introduced to **Klaus Dona's** finds from an Ecuadorian archeological dig, and I might have gasped when I saw the images. One of the cups dated deep into antiquity was a stunning cobalt blue with brilliant white lights depicted in the same geometric patterns shown to me that night. Obviously I was not the first person to have been subject to this same world-changing disclosure process because these aren't zodiac patterns way out in the sky, they were right there in front of the witnesses' face:

Decoding The Hive

creation of gravity, light, time and the god particle



OTHER THINGS

The very next thing she said to me was to ask if I had seen *“the other things as well”*. I answered no, as I was left barely conscious just from seeing what I had. That’s when she informed me that; *“there had been 2 planet-sized space-crafts right in front of us the entire time, one to each side of the display theater. In fact, there was no visible sky at all in front of us the entire time”*. I said no, I didn’t see that, visibly alarmed. I honestly don’t think I could have continued consciousness if I had witnessed something that utterly unbelievable. Then she said *“and there were hundreds of dead people walking in a continuous stream from the harbor and up the bank toward our balcony as well”*. That’s when I said had I saw that, I am sure I would have fainted. Then she said *“the brain is fitted with “breaker switches” so if something outside of the ability of the brain to process is presented before them, the first breaker switch goes off to protect the circuitry*

Decoding The Hive

creation of gravity, light, time and the god particle

from overloading. Had you actually seen either the planet-sized crafts or the dead people approaching you, then those images would have tripped the secondary breaker at the back of the brain. Those images you were unable to process would have either disconnected your brain's circuitry permanently, or you would have died from fright".

I can honestly attest now that had I seen "the other things" that night as 100% unprepared as I had been for something so outrageously paranormal, that I would have at least passed-out if not actually died. Since this explanation on the breaker-switches in the "human" artificial brain, Aug Tellez (a Secret Space Program whistleblower) has explained it the very same way, that if you are not prepared to see beings from other dimensions (or similar), that you will either go permanently insane or more often, literally die. Asylums are filled with people who's brains allowed-in the initial view of images they were unprepared to see which caused the complete snapping of the electronic receptors of the conscious brain which disconnects them from being able to process anything logically again from that moment forward. The "main breaker" to the brain is actually much less a "breaker switch" than it is a fuse that burns all the way through leaving no way for further electronic signals to get through from your reasoning center to your consciousness.

Since I had told her not more than 2 weeks prior to this meeting that "I was ready for the whole picture" of what was going on, and that I could handle anything she threw at me, she was visibly disappointed when I told her that I hadn't seen the other things before us. I'm not actually allowed to explain now why it was she was disappointed at that, but it did have something to do with where I would have been relocated to next had I actually been "ready" for the interstellar theater, and that relocation would have happened during our meeting. She explained to me that after having held my vibration at that frequency for the time that she had, that if I were truly ready, then I should have easily been able to keep my vibration at that level on my own with that prompting. I was NOT ready for anything more than the years of education that would be following this unbelievable display and the interstellar communities would, at least in my case, have to wait.

STASIS

Immediately following the lightshow my contact announced that she was absolutely exhausted and could no longer stand up after such a marathon of controlling my frequency that allowed me to see outside of this reality and lay down to rest. Naturally, I was still bouncing off the walls, so I tried to wake her and got no response at all. I tried to move her arm and it wouldn't move more than an inch or two, as if she was frozen. As I pried it over slightly to one side or the other, it would snap back like it was only allowed to be in that one exact position. It didn't seem like she was even breathing, so I tried to move her by the shoulders, and she would just snap back into the same position she had been in. After about 4 hours she woke and the first thing she said was "Ow, what happened to my shoulder?" I explained that I had tried to wake her but she wasn't responding. That's when she said; "I wasn't sleeping, I was at council for 3 1/2 days". I responded "but you were out for only 4 hours" and she told me again that time does not work the same in higher dimension as it does here.

Decoding The Hive

creation of gravity, light, time and the god particle

Since then she has explained to me that when she reports to council, she leaves her 3rd dimension body here in stasis, as it is unable to transmute into the higher planes. Not long after that, Corey Goode reported the discovery of “King Anunnaki”, found in a stasis chamber after some 12,000 years in the same condition as if he had laid down to sleep yesterday:



The nine-foot-tall giant's copper-colored skin was just as supple as if he were still alive. This is exactly what I have seen personally when my contact reports to council, so it is not fiction. They slow down their heartbeat using their breathing until it is almost not moving at all, then they disconnect from the body and their awareness simply goes somewhere else. The body can remain in this state nearly an indefinite amount of time living off of the aether alone:

Decoding The Hive

creation of gravity, light, time and the god particle



Of course I didn't even know what it was I was looking at that night, as I had never heard of stasis before. But since then she has explained that it is a very serious problem while raising her children in this dimension (both Indigos from Earth history dating back to the beginning of human time), because every night she lays down her Avatar to rejuvenate, and then spends a few days at council, she is gone. And if the children have a nightmare, or need mommy for some reason, then they have to just wait, even if they are in hysterics, because even if you were to pour ice water over her, it wouldn't make any difference, because she is simply not inside that body. It is a full disconnect.

METAPHYSICS

Decoding The Hive

creation of gravity, light, time and the god particle

My experiences with the paranormal did not end that night, they had only just begun. Since then there have been too many to count. But I will cover a few of them here so you have some idea of what it's like to be in direct contact with such beings.

About 2 months after *the lightshow*, I was outside on my front lawn having a cigarette and looking up at the stars. My education had not backed off, so my head was swimming with hundreds of pieces of the puzzle trying to connect into the bigger picture of what was really going on, just as always. Suddenly like a lightning bolt from the blue it hit me; "*we are under a dome, and the stars are gobo-spots!*" At the same moment it dawned on me that the Zodiac signs were geometric codes that were projecting down standing scalar-waves with commands that kept us inside the Chimera Reality as council refers to it. I was left absolutely speechless, my mouth was actually hanging open and it felt like the single biggest secret in our world had been handed to me all at once. At that same moment, my head tilted back down as I tried to gather my thoughts rushing through my head, and right there in front of me about 6 feet above the roof of my house was a six-inch ball of white light! It hovered right there for a few moments and then it dropped down a few feet and whisked away off to the left, vanishing before my eyes.

I can't be sure if I was the one to call my contact next or if she called me, because I had been experiencing the extremely bizarre reality that when I would come across a very important question in my mind that I genuinely needed an answer to, my phone would just ring the very second I was grappling with it. I would say "*oh my god, I was just thinking how badly I needed to talk to you just this very moment!*" and she would say "*I know, that's why I called*". But the very next conversation I had with her following this dome/Zodiac moment I asked her if that was her in plasma form that appeared that night, and she said "*yes, I just wanted to share the moment with you*". That's when I learned that I had been 100% correct on the dome, on the Zodiac and on the stars. She would later go on to tell me more about the Atmospheric Membrane, and the fact that the water and crystals that it is made up of reach a point (of moisture evaporation) by the time they collate to produce the dome, that mankind literally doesn't have a word yet for it, but yes, it is effectively "frozen crystals". This will be explained in detail later in this report.

Over the past few years it has become incredibly common for me to get an email out of the blue from council informing me that my diet isn't right or that my health is waning, along with very clear instructions about what to add to my diet, or to "drink local herbal tea because you have become slightly congested". I held a seminar here locally (a few thousand miles away from where my contact is currently residing) some time back where I discussed the "980 Million Year History of Humankind". Immediately following the lecture I got a call informing me that I "*had done a great job and they were pleased with my presentation*". She had been there watching the whole time.

Since most mortals do not have the psychic abilities they once had, it is almost impossible for us to understand how beings are able to keep track of others from thousands of miles away, but trust me, this is now an extremely common occurrence and it no longer freaks me out like it used to. The night of *the lightshow* I was informed that "*not only is every word we say monitored at all times, but they are also recorded*". I take that to mean that the surveillance continues even while

Decoding The Hive

creation of gravity, light, time and the god particle

I am mumbling to myself in the bathroom. I suppose it is no different than The Truman Show, but still it is somewhat unnerving to know that there is no such thing as privacy anymore.

CHAPTER 3

MISSION RESURRECTIONS



I will not spend a lot of time on this subject, but in the same vein as the previous chapter, I have been informed of which dimension I am in each time I am resurrected and about my walk-ins. Yes, I have died since my mission began, more than once.

Walk-ins are **Nephilim** beings or **Oraphim Angels**, depending on the type of walk-in your Avatar is hosting. These are distinctly different breeds of cat. *Literally*. **Oraphim Angels** are **Krysted Ascended Masters** from the **Halls of Palaidor**, **founding fathers** of the **Angelic Human** species who have entered **Indigo Birthing Contracts** to serve on the **Azurite Universal Templar Security Extraction Team** as Planetary Energy Grid workers, genetic-repair workers and as education hosts for **Nephilim giants** known as the original *fallen angels*. The education process the Nephilim must go through repairs their genetic structure, aligning it with the **12-Strand DNA Template** of the **Angelic Human** species. This special arrangement where

Decoding The Hive

creation of gravity, light, time and the god particle

Oraphim Angelics volunteered to “babysit” the Nephilim was afforded through the **Co-Evolution BioRegenesi s Treaty of Palaidor** which would allow beings who had become disembodied and had not been coded for this dimension a way to ascend and escape an otherwise eternal prison.

The Nephilim were 15 to 25-ft tall giant “humans” from **Antiparticle Gaia**, a higher-dimensional “mirror” planet within the **15 Level Time Matrix of Gaia**. This human species appeared somewhat similar to Angelic Humans, but differed in that they had cat-like features, were gigantic in proportion to modern humans and had petite, child-like facial features. 568 million years ago the **Anu-Elohim** group known as the **Michaelube, SUNS of Ba’al** swept into their lands, bioformed (raped) them into slave warriors, coopting them into service to stop the **Angelic Human Krystos Experiment** from continuing here on earth. Just like the rest of the “bad guys” who wound up torturing and murdering humans throughout this painful drama, they were not so much converts as they were **abductees**, forced into service *or else*.

While the **Oraphim Angelics** are also “human” in form, similar to the Nephilim, they too have cat-like features and are descendents of the **Elohim Krystos Holy Gra-Al eternal-life bloodline**. Hence their **Krysted Ascended-Master** status. The difference between simply *ascended mastering* an **Avatar** and *Krysted Ascended-Mastering* has to do with the status of the genetic template you are bringing back to the **Deity Planes**. Merely fully ascending a **vampire Avatar** out of a lower-level Time Matrix is common, but bringing back an **eternal-life Avatar** is another thing entirely. I will explain the difference later in this section. Suffice it to say that *Krysting* is a very big deal. The Anu-Elohim (Krysted Masters) did not agree with the **Turaneusian Project** (you) that was bringing a highly-advanced new **Holy Gra-Al eternal-life species** into being, as their senses were hyper-accute meaning their emotional highs and lows would be outside of the spectrum of any beings who had gone before carrying the **Krystos** blood that allowed them to hold manifestation eternally. This means that Angelic Humans had the capacity to allow their emotions to become more out-of-control than other Elohim beings who had come before them. Similar to “Spock” from Star-Trek who had little emotions; previous Elohim had not been so dangerous, because their joy and sorrow extremes weren’t as acute.

It was this *potential* that caused all this destruction and bloodshed to begin with when the Elohim decided to stop this new evolution in order to “protect” the Deity Planes from the possible carnage such beings might wind up causing. Something on the order of the film *Minority Report* where the police arrested perpetrators before the crime was even committed.

INDIGO TYPES

Type 1 Indigos carry tremendous electromagnetic energy. To compare this to humans, the average person walking down the street has approximately .73mv of electricity that their internal fission/fusion reactor generates from the food they eat and also from inversion of the sun’s waves. This is less than **1/1000th of one volt** to put it into a frame of reference. The **Nibiruean Diodic Crystal Energy Grid** (described later in this paper) that was overlaid on top of the organic **Krystal Cathedral Energy Grid** that normally modulates much higher frequencies within this dimension is partly responsible for this extremely low harmonic vibration (you refer

Decoding The Hive

creation of gravity, light, time and the god particle

to as the **Schumann Resonance**) that is tuned to the precise frequency spectrum of the Angelic Human and like an overwhelming symphony, overtakes the rest of the frequencies present, forcing them down to a very low vibration. **Indigos** however were designed to produce a vastly higher frequency tone than Angelic Humans so their *operating platform* was outside of the main thrust of this moderating wave. Since the **Zeta/Draco Frequency Fence** harmonizes with this low frequency as well, which maintains **7 separate layers of invisible force-fields** blocking all entry in and out of this atmosphere, the Indigos rise above those frequency thresholds to some degree, which is why they have super-human abilities while here in manifest form.

Type 1 Indigos have power that is stunning to witness. I know, as I have activated more than 200 Indigos to date, placing them back fully under their contracts, so I have spent many hundreds of hours talking to both Type 1s, Type 2s (and Type 3s who have turned *into* Type 1s. More on that as we go). A Type 1 commonly blows light bulbs out by walking past them, or reaching to turn on a lamp. They also turn out street lamps just by walking underneath, or simply *thinking* them on or off. We have Types 1s who turn off every street lamp they drive under going through town just like clockwork. They most often can see through the veils into higher dimension slightly (seeing angels and other entities), and often have the power of telekinesis and telepathy. Many of them are able to converse with animals, and I do mean that they have a 2-way conversation. Type 1s are hyper rare and after activating over 210 Indigos, I would estimate that only 3 of them were Type 1s. I have had at least that many if not more Type 3s who have *turned into* Type 1s as well which happens when they have fulfilled their mission to rehabilitate the full group of Nephilim they are hosting, at which time their **Type 3, 24 to 30-Strand Awareness Oraphim Angelic** steps out and a **30 to 48-Strand Awareness Oraphim** steps in to take over the rest of the mission from there. Their aura is completely different from a Type 1, but their powers are just as epic.

Type 1s were placed here to do **Planetary Energy Grid** work (overcoming the **Nibiruean Diodic Crystal Grid** frequencies and restore the correct code patterns of the **Krystal Cathedral Planetary Grids**), therefore their energy signature is roughly twice as high as that of Type 2s, who's job it is to do plasma body repair work which requires tremendously less energy than working on a planet carrying trillions of amps of electricity. Because of this extreme electromagnetic force, Type 1s are unable to birth into a fetal body like other Indigos and humans do where the prana seed simply carries the harmonic signature of that plasma being from a point of a few weeks into pregnancy when the **Sentient being** physically joins the developing fetus. If the Type 1 were to enter into such a delicate, undeveloped Avatar, then both the fetus as well as the mother carrying it would simply vaporize. This is why Type 1s experience what is called a *walk-in*.

The Type 1 walk-in is an **Oraphim Angelic** entity. This generally happens around the date when a child reaches adulthood, giving the Avatar plenty of preparation to host such a massive energy signature. Adulthood, at least physically-speaking is the age of 12. **Two Sentient beings** will enter into **one Indigo Birthing Contract** together to accomplish this, where the first agrees to manage the Avatar from fetal development till the age of puberty and at the precise agreed-upon moment, that being “walks out” and the being carrying the *mission-contract* for planetary service (as well as leadership in establishing sanctuaries and healing centers), walks in. Due to this plasma-body shift, this can often disconnect a Type 1 from their early childhood memories that

Decoding The Hive

creation of gravity, light, time and the god particle

were actually experienced by a different being altogether than the one taking over for the adult-contract period.

To my knowledge, **Type 2** Indigos do not experience walk-ins, as they are able to birth in with their **24 to 30-Strand DNA** signature through fetal integration.

Type 3s also experience walk-ins, but it is a different program entirely from the Type 1. They will be born fully integrated into the fetus from birth, as they are carrying a 24 to 30-strand genetic code (the same signature as the Type 2 Indigo) which is effectively ½ the electromagnetic energy of the Type 1. However this is still hundreds of thousands of times more energy than the average person carries today. At this time, even from their earliest days, they will be hosting a **Nephilim** being who will be *sharing one awareness with the Oraphim Angelic*. This means that their mind will have two signals urging them to do one thing or another, not unlike the cartoon image of an angel on one shoulder and a devil on the other, both whispering in the person's ear. Often this causes what is known as **bi-polar** disorder, **Asperger's** and other **Autistic** traits. The reason the Oraphim Angelic is cohabitating the body with the Nephilim is complicated, but suffice it to say that the Oraphim is working as a "babysitter" of sorts, teaching the Nephilim how to become *a human*. Since Nephilim were bred (or should I say re-bred) for conflict and war, the gentle and loving ways of an Angelic Human are foreign to them and it is a huge job to recode the genetic structure of a plasma-body to become something they were not originally harmonized be.

The Type 3 will not be hosting just one Nephilim during the term of his contract, but will rather be serving a large group of 50 or 500; I haven't yet been briefed on the number. Since there are only roughly some 250,000 Type 3 Indigos who have volunteered to serve in this extremely difficult capacity, and there were possibly millions of Nephilim who had been co-opted into service by the Anu-Elohim to destroy the Angelic Human evolution, there simply were not enough hosts to help each one individually. This means that each **Type 3 Oraphim** will serve as a *walking stargate*, enabling ascension to their group of Nephilim, should they successfully complete their task.

Type 3 Indigos will experience *shifts in consciousness* as they experience Nephilim walk-ins. This type of walk-in happens when one Nephilim has been taken back to past lives by his Oraphim host, and has relived the moments where he or she caused imbalance in the spacetime fabric. Since the Nephilim originally came here as an abductee and turned into a compulsory soldier, they have universally committed very serious acts of murder, rape, torture, etc., causing rather large imbalances in the aether. Each one of these acts must be accounted for and restored in order for the Nephilim to elevate in frequency and disconnect from this playing field where they would otherwise be stuck and disembodied until such time as each of these distortions had been organically repaired. *Organically* meaning the aether would have extracted the positive energy back from the Nephilim through multiple different ways, such as sickness, broken bones, etc. But since the Nephilim is working with the **Ra Confederacy** and the **Emerald Alliance** under the **Co-Evolution BioRegenesis Treaty of Palaidor** to become human, Oraphim Angelic volunteers from Palaidor have agreed to massively speed up this process for them by showing each one how to repair these distortions at a high rate of speed.

Decoding The Hive

creation of gravity, light, time and the god particle

What I mean by this, is that during sleep and waking times, the Oraphim host will be bringing the Nephilim through *sub-conscious awareness* (think of this like a “carrier wave” of your “awake awareness”) back to these moments of distortion, and helping them relive that moment where they had perpetrated the harmful act against another Sentient being where they now become friends with that person, or help them out of their difficult situation instead of murdering or harming them. If they can visualize this in their mind clearly, it replaces the previous action with a new timeline where the damage did not occur. Each distortion that is erased in this way raises the frequency within the plasma body of the Nephilim. Once all such actions that had caused the balance of electromagnetic particles which had been holding the holographic image at that precise spacetime vector to become negatively charged (causing a “black-spot” in the video frame) have been repaired, that Nephilim is now cleared for ascension. At that time, that Nephilim will then walk out of the position of operating the Avatar, and the next higher-vibration Nephilim standing in line as it were, will step in.

At this point, the Oraphim Angelic who is performing the service of restoring all these many beings will experience a shift in their being. Old habits will simply vanish along with ritual activities that they had perhaps performed all of their lives and they will notice that they simply feel different. That’s because the Nephilim who is now *sharing the one awareness* operating that Avatar who just walked in, is a completely different being than the one that just walked out. (This is further explained in my video series **Indigos Are Here Under Contract.**) A Type 3 Indigo will experience this type of personality change many times during their life if they are successfully restoring their group of abductees back to wholeness. And of course, this often leads to that person being committed to an asylum for “bi-polar disorder” because it seems like they have just instantly changed into a different person. Where there is such a thing as possession by negative entities that can cause such universal changes in a person overnight, this is not to be confused with that condition. There is nothing “wrong”, in fact it is quite “right” when this happens to a Type 3 Indigo. Yet since the mission of the Type 3 has never been revealed to the medical industry (they would claim), it is treated as a mental disorder.

*The Oraphim, as well as the group of Nephilim all “think” they are the same person, because they must share awareness in order to run the Avatar. However, the current Nephilim who is operating the body is the one who is living their life at the moment. (This is **not** the **Oraphim Angelic** who **is not** actually living their life, but is there *only* in the role of **Wayshower**. Oraphims are not here under “freewill choice”, their lives are being guided at all times by their higher-self, meaning they *do not* have the option to simply choose which job the Avatar will hold down or which person it will marry and have children with. When the doors open for that Avatar to walk through, it will just happen.)* When the Nephilim attempts to fall back into its old habits of subjugating others, it is the Oraphim’s responsibility to reel him in and prevent him from doing that damage, as the Oraphim has dominion over the body in order to facilitate the Nephilim’s education. This too causes Type 3s to feel continuously frustrated because they want to do one thing or the other, but they simply aren’t allowed to, so it is almost like having legs that won’t work right which is terribly confusing. This leads to alcohol and substance abuse quite often as they are seeking to dull the pain of confusion.

With each Nephilim completing their past lives’ distortions, the frequency of the entire group elevates. It is my contention that when the Avatar is born, the lowest-frequency Nephilim is the

Decoding The Hive

creation of gravity, light, time and the god particle

one who is currently “driving”, and with each successful past-life completion and new walk-in, the Avatar also experiences a shift in dimension, because collectively they are resonating with a higher plane. This happened to me, and it was spelled out for me that if you are actually following the **Pan-Clair-Ah Awakening Waves** filtering in during the **Stellar Activation Cycle**, then you will be moving from one “nested” dimension within the 3rd Dimension higher or lower as you go. I can only guess at how many sub-dimensions there are to step through on your way up “Jacob’s Ladder”, but when it happened that I noticed a stark difference in my scenery overnight, that’s when I was told that I was now “*in the 4.75 dimension*”, leading me to believe there might be something on the order of 100 interdimensions on your way to completion of your mission.

Let me explain how I was in the “4.75 dimension”. Anytime you are in a Time Matrix and in manifestation, your oversoul or awareness operates in one dimension higher than where your physical Avatar is in manifestation, overseeing from a distance as it were. This means I was then currently in the 3.75 dimension, while my *oversoul* was in the 4.75. However, this was not the only thing that changed that day, as you will soon see.

When the Type 3 has finally completed all past-life repair with the entire group, that’s when the frequency of the physical Avatar jumps up to the full vibration of the *24 to 30-strand DNA Oraphim Angel’s*, and it is at this time that their electromagnetic energy is sufficient to perform energy healing exactly the same as a Type 2, since the *DNA template in the Type 2 and Type 3 are the same*. In some cases the Type 3 will begin healing in this way prior to the final Nephilim completing, but once they have finalized each one’s journey to wholeness, you will notice a significant jump in energy. This begins the **transition** time where the Avatar will begin to work in the healing arts (through energy healing, acupuncture, acupressure, holistic medicines, or even through their art such as music or painting and many other forms. *Any artistic expression that you create will hold the invisible scalar waves added by your higher-self that will work to heal the DNA codes within all who come in contact with that work*). Soon the group is ready for the next **host** Oraphim to walk in.

At this point, the 24-30-Strand Oraphim has completed their contract as a “**Type 3 Indigo**” and will now step out, making room for a Type 1, **30 to 48-strand DNA Oraphim** to take over as mentioned above. Now that the body is no longer having its frequency reduced by the low-frequency Nephilim, the Type 1 will be able to use that much greater power held inside their **Hyksos human hybrid body** for much more useful tasks as mentioned earlier. Energy healing will be simple business for them, something they can do in person with the patient, or over the phone half-way around the world. This however, is also within the ability of the Type 2 healers as well. Just the fact that the Type 1 is physically standing within the morphogenetic field of earth alone will be a very powerful addition to healing the DNA of humans and hybrids on a global scale. With roughly some 250,000 Type 3s, I estimate there to be perhaps as many Type 2s, with only a very small handful of Type 1s on the planet. *Every Type 3 has the potential to bring Type 1 energy to this playing field*. While being a Type 3 is extremely challenging, and a great many do attempt suicide due to the difficulty, there are no other Indigos more deeply honored within the ranks of the Azurite Templar Security Team, as it is looked upon almost as a suicide mission. It takes tremendous courage to come down to this prison field under a Type 3 contract.

Decoding The Hive

creation of gravity, light, time and the god particle

RESURRECTIONS

Even though this seems too outrageous to even consider, I am forced to share my experience with resurrection, as I have been brought back to life more than just one time and I feel this topic deserves to be included in my disclosure. For those disbelievers out there, all I can say is I am passing along to you exactly what I experienced first-hand and also as I was informed what had happened by Council. I am not embellishing this even in the smallest degree. It is certainly up to you to decide if you feel I am imagining the events below, but that will never make this report untrue.

I had moved from the US to South America in the first half of 2015 to start a sanctuary which I knew had to be established, even though I had not yet been tasked with this specifically at the time. I was very clear that we needed the **Security Team** to come for activation, and that if we didn't provide sanctuary for the humans surviving the soon-coming apocalypse, no one would. The coming months of total isolation proved very difficult, and added to that I came under psychotronic attack by forces who were not pleased with the fact that I had begun performing official Krystenings on behalf of the Guardian Alliance. This led to the complete failure of my Avatar apparently and I passed away two times within the first few months. However, I was unaware this took place, as the resurrection happened seamlessly during the night during sleep.

The third time I succumbed to the overt psychological warfare, I had resorted to the only medication I had in the house to dull the pain and knowingly drank too much alcohol to survive. All I wanted was for the mental torture to stop. This time I woke up the next day knowing full well that something was wrong, because I didn't have a hangover (which I should have felt on the edge of death for at least 3 days if I woke up at all). I went to my bedroom window to have a cigarette upon waking the next day only to notice the very dark-green grass and trees outside had suddenly, overnight, turned yellow. Since I had been standing in front of my window for as much as 8 to 12 hours a day for the previous many months while performing activations via VOIP looking out across the forest and trees, I was as familiar with their colors as you might be with the color of your hair. Of course neither grass nor trees turn yellow in one day, so I freaked out and called council to see what had happened (because I know they are *always* keeping an eye on me).

I explained the situation and how I knew the landscape better than the back of my hand, and the trees and grass were never yellow before, so something was very much amiss. That's when I was informed nonchalantly: *"You died again, and had another walk-in. Oh, you are now in approximately the 4.75 dimension"*.

I had never heard of any of this type of thing before, so I was instantly dazed. So much so, I didn't even ask what was meant by *"you died again"*. (You will find out first hand some day what it is like to experience metaphysical realities yourself too I am sure. You are lucky just to maintain consciousness, let alone a clear head.) I would much later come back to that question which was actually just a few weeks back, for clarity sakes. It was at this time I learned about

Decoding The Hive

creation of gravity, light, time and the god particle

Type 3 walk-ins, about multiple dimensions within this overall 3rd Dimension, and most off all, that *I was absolutely not allowed to die and remain dead.*

When I say that I am not allowed to die, I will need to clarify that a little bit so you don't get the wrong impression. Just like the rest of the *humans* currently on the planet, I went through mind-wipe at my recycling, so who I was before this only comes to me from Council and from sparks of past-lives that might surface for me from memory bursts. Many Indigos have a strong recollection of their past-lives, but that is not my case. I cannot recall my previous positions, but I do know that my bloodline comes directly from Anunnaki royalty. Indigos are not here just in Angelic Human bloodline bodies, *they are evenly distributed across all invader-race and Angelic Human hybrid bloodlines*, because our perfected frequencies are designed to restore the highest level of genetic imprint for all of those under the **Co-Evolution BioRegenesis Treaty**. Like all other Type 3s, I am here in a **Hyksos Avatar**, but in my case the genetics of this body's lineage travels back through kingships directly to King David who ruled over the **Adam and Eve hybrids** in pre-biblical times. I was told from perhaps the very first day of my contact that my bloodline was Anunnaki and that I need not be concerned, because "*the Avatar you are inhabiting does not dictate your heart or your compassion for the greater good*". Service-to-self is a choice and it is up to each of us to either choose the way of the dark forces, or to choose the Law of ONE.

For some reason my contract was written in such a way that it did not allow me an "out". I can only assume this is because I had known at the time of negotiations that if given the chance to back out, *I probably would*. Because the fight down here is simply much more difficult than mortals are prepared to wage if given any options. On top of the fact I am supposed to bring this information to the world which will lead to *massive* push-back across the planet, I am doing this while serving Type 3 contracts and had always been extremely cosy with the idea of suicide since I was born. The fact is, I will have to do the largest portion of my disclosure program from deep underground where it is difficult to locate my whereabouts unless I want to welcome some 500 black-ops agents in my back yard. This means the job will be intensely isolated and in a country where it is fortunate to have heat or even running water at all, much less hot water.

While I can die, I am just not allowed to *stay* that way. However, when and if I do die, then that is literally removing one of the "worlds" from my "ladder" to ascension, because when I die in let's say the 3.70 dimension, then I will never be able to go back to that specific world again, because there, my Avatar is deceased. I have clear memories in my younger life of being murdered and dying, but because I simply came back the next day, I always chalked that up to my sensationalizing that event. But I can say with conviction that when I was 18 at a riverside party I had not been invited to and decided to just crash one night when I saw the festivities, that I am certain I lost one of my Avatars. Immediately upon arriving to the party, a very large young man approached me and was obviously very agitated by my presence. For whatever reason while growing up and attending the same schools together, he had developed a sincere dislike for me (which I likely deserved for some reason or the other) and now that he was twice my size, he was going to set the record straight. He grabbed me around the throat, dragged me into the freezing river, and held my head under to drown me. But here's the thing, I remember struggling, I remember how cold it was, the blackness of the water, and I remember walking up the bank to

Decoding The Hive

creation of gravity, light, time and the god particle

my car and driving away. I *do not* remember ever breaking free. I am not the only Indigo with similar experiences which I have had recounted for me many times since activations began.

When I spoke to Council recently to ask exactly what she meant by “*You died. Again.*”, she said that during the first 9 months of my arrival in S. America, I had died 3 times and “*had been brought back to fulfill my contract*”. Obviously I don’t come before you as a hero or the reincarnation of Jesheua Sananda, because I am just as mortal and susceptible to pressure as the next person. All I can do is my best while struggling through the job I didn’t know I had arranged for myself until my awakening and being shoved head-first into my role. I asked Council who it was that keeps bringing me back, and she said that she didn’t know that part of my contract, but she knew for certain that someone was making sure that I was *not* able to vacate the covenant. According to what I have been briefed on, and since my official position is a military contract, I can only assume that would mean that the Emerald Council who is in charge of the Guardian Alliance Azurite Universal Templar Security Team of Tara Earth would *legally* (under pre-arranged contract stipulations) be allowed to bring about my resurrections. As I understand it, resurrections must be pre-arranged as part of the mission parameters, otherwise are simply forbidden during this era.

At the time I had first learned about my resurrections, I was very concerned that with each Nephilim that repaired their past-life distortions, that I would have to die again in order to host the next one because I still didn’t understand that I had been under psychotronic attack. I thought I had just died from stress and drinking too much. (For Christ’s sake, if I am hosting around 50 to 500, that is more times than I am interested in dying.) But that question became clearly answered just 2 months later when I awoke one morning and all the yellow had simply vanished overnight and the grass and the trees had returned to dark green again. I contacted Council of course for clarity (let’s say I wasn’t *hysterical* over this, but I was *really* concerned), since it was absolutely clear that I had moved to a different dimension again, and yes, I had moved on the frequency ladder again, this time slightly back down a rung or two. This had me very startled, since no one wants to *backslide* on their way to ascension. I was told that “*Ascension is always this way. You will never continually move only forward up the staircase, because it is always a “dance”. You will take 2 or 3 steps higher, then soon 1 or 2 steps back. But as long as it is always a forward progression ever higher, there is nothing to worry about and is completely normal.*”

I need to clarify what I mean by “levels” within this dimension. Each full Dimension is apparently made up of many mirror-image worlds that are in different *Timelines*. The Timeline of let’s say the “3.01” dimension is *generally* visually the same “world” as this one is, but the spiritual understanding of the beings there is vastly lower than that of higher dimensions. I suppose this is much like the difference between the 3rd and 4th Dimensions where your visible spectrum is dictated by your frequency. These *interdimensional* worlds are carbon-copies of the one you are in now, complete with a real-live copy of yourself. The difference is, your *awareness* is in the dimension that it is in, and the copies of you in the others are not choosing their own actions, but mimicking yours from that dimension or “level of the staircase”. This way all the worlds remain virtually indistinguishable from each other (to maintain the spacetime continuum), but allows you to remain in the “3rd Dimension”, while making choices that either elevate or lower your position. Your other bodies in these different interdimensions can be

Decoding The Hive

creation of gravity, light, time and the god particle

thought of as placeholders for your awareness to step through as you continue to ascend, or *descend*.

To illustrate this, imagine making the decision today to purchase a rifle and some bullets, and then take a trip down to Walmart to mow down as many people as possible before you ran out of ammo. I guarantee that tomorrow when you wake up, if you are not dead after that, you will no longer be “in the 3.54 dimension”, but will have stepped back down the ascension ladder to more than likely, the 3.01. Every possible action you can take within manifestation has already been played out and continuously remains playing out in a never-ending loop. These loops or “bubbles” of time may be just 1 second long, and they may be an hour or day or year. You are able to step directly into any one of these bubbles instantly depending on your last choice of action. When you get there, you will be completely unaware that you hadn’t been “there” all along, because “time” is not linear.

I know you have heard this before, that time does not follow one path, and what you did yesterday wasn’t really yesterday, it was only how that memory was placed into your brain’s random-access memory banks *as* “yesterday”. Here is how I explain how it works: Every moment and experience possible given your two legs, two eyes, two hands etc, (meaning you cannot fly, but you can run and operate heavy machinery while under medication should you so choose) are like drops of water. The loop is playing out before you even arrive within manifestation. Now take all those drops of water and pour them into a length of hose and close off the ends and give it a shake. The first drop of water that pours out once you open one of the ends (make a choice), may not have been the first drop that you poured into the hose to start with, but it was the drop you chose to “visit first”. And as you continue to choose other experiences, those drops of water “stack up” in your memory-bank in a linear progression, giving you the sensation that “you had a red bicycle when you were 9, and then you got engaged when you were 23”, because that was how you “assembled” the water drops.

However, at any given time, you can decide to make better choices which will lead you to far more “advanced” droplets or event cycles of experience, replacing what you “did when you were 9” with a different set or series of events that would follow, making up a completely DIFFERENT Timeline as “your history”. And you will NEVER KNOW that that had not always been your same history, because the transition between each drop or *event cycle* comes with its own blending mechanism that inserts that memory as “yesterday” or as “20 years ago” which in turn selects all the event cycles leading up to that decision that would cohesively blend together to make up your now *current* Timeline. As you can see, your Timelines have changed trillions of times as you have progressed to the point where you have chosen to read or listen to this disclosure now. And it can change again to vastly lower Timelines or higher Timelines, depending on what you DO with the information you are being given in this report. Your next Timeline or event cycle will be dictated by your *actions only*. Not by your good intentions.

If you read this information, then you decide to join a Satanic cult and worship Marduk, you will be hopping down your ascension ladder as quickly as your feet can carry you until you reach the starting point again. But if you decide to take action and sell your belongings and move to the country where you will be able to fully sustain yourself and your family living off the land, extricating yourself from the Babylonian Magic Money program, then you will be writing

Decoding The Hive

creation of gravity, light, time and the god particle

yourself to a ladder rung that results in a much less difficult history that you will have had to have suffered through. The only way you will know which rung of the ladder you are on is if what you are seeing around you continues to progress toward ascension. This means that you will *see the signs in the sky* as you were warned of in the bible program that would be present in the end days. Those who are literally unable to see the second sun that is rising and setting in our skies over the last few years (flatly denying that it is there, even though they are being shown 100 different pictures taken from 100 different cameras from 100 different places on earth) are not *seeing the signs*, because they are not actually *there* with their awareness, but they are merely mirroring the physical movements of their higher-self in some other interdimension.

This answers why cognitive dissonance is so utterly confusing in that those who stand right there and **deny** what is being shown to them with every fiber of their being even when the evidence is overwhelming, literally does not make sense. Almost as if they aren't actually *there*. But in the truest sense, they aren't there, and they can't actually see it, because they don't have cognizance with which to discern for themselves *in the interdimension point you are standing in*.

If you are merely a holographic mirror of yourself while you seem to be present, you are not *actually* there. Mentally. It would be impossible to think within that dimension, but rather merely puppet what their aware-self is seeing in the dimension where their awareness is actually located. Since each dimension is under a different holographic platform, or frequency-spectrum, in the 3.01 dimension for example, they are able to see, hear, smell, taste within the parameters of their senses afforded by that limited spectrum, *not* the spectrum of higher levels. Where their thought-processing is happening, there is no such thing as "two suns" in the sky, because that TIMELINE hasn't yet progressed to the point where they can comprehend something on that order. Again, they are merely placeholders, even though they seem alive and alert. If they are merely a placeholder, they are likely not one of those who are stepping up the ladder and if you were to visit the 3.01 interdimension, you would likely meet the one version of them who was making all the decisions for all the rest of the placeholders.

There is a test each Indigo can take to tell if they are ascending (vibrationally moving higher) or not. If you have initiated a consultation with Avalon seeking reactivation of your contract, ask yourself if you are actually ready for what you will learn, or if you are only going through the motions. Through my contacts, we know for certain that my aware-self (physically) is in the 3.75 dimension (thereabout). Because of this, if you are acting on the information being given to you during our time together, you can be fairly certain that it is your aware-self that is now speaking to me. But if I give you instructions on how to proceed under the terms of your covenant and you simply ignore them, then we are not actually both in the same dimension together. While this is an extremely difficult concept to grasp, I feel the only way you can be certain that we aren't just mimicking our true selves is whether or not you are responding to the dialogue. If you feel a burning desire to fulfill your mission requirements following that connection, then I am convinced that it was actually "you" I was speaking to and not your placeholder.

Actions can only come from the spark of thought, and you will not have that spark if you are merely mirroring the actions of someone who is unable to see that the second sun is in fact in our skies in this dimension. Of course I use that term euphemistically, as you already know by now the second sun is the what we might call the *United Nations of the Cosmeias*, a planet-sized

Decoding The Hive

creation of gravity, light, time and the god particle

biocraft parked in the skies of the ASCENDING dimensions (above the 3.01). Has it been explained to me that the IAFW craft is only visible in the dimensions that are ascending? No. But there is literally no other way to explain how it is that those of us who absolutely know our lives have become paranormal over the past 4 years are also able to see and comprehend that these are not just photo-shopped images. There might be 10 or even 30 morons who feel it is worth their time to create hoax-images of a second sun in our skies just for the fun of it, but that doesn't explain how the images continue to come forward from every geographic location around the globe, year after year. The first images would be funny I suppose to some, good for a laugh. But the 50th or 100th or 500th would not be worth the time to fake because the shock factor would long since be gone.

I have shared MANY dozens of photos and live video-feeds of MASSIVE UFOS to my readers (I don't even bother with the small ones anymore, as they are being video-taped and photographed around the world hundreds or thousands of times every single day now and have gotten old). These are images that have been forensically inspected by digital experts from as many as a dozen different laboratories from different countries, featured in mainstream newscasts and shown to be absolutely authentic. I have also done this with videos (often directly from official newscasts) of 9 floating cities (with a 10th one so far that was so utterly outrageous that not even I would share it, even though it was obviously legitimate. Even those truly ascending are not yet ready for just how strange things really are in higher dimension.) Only those who are physically responding to the Ascension Waves (Pan Clair-Ah waves, etc.) explained in the next paragraph, see these and accept that they are authentic. The rest dismiss them as if they couldn't possibly be real, so no matter how much evidence is brought forward, they will never, ever recognize them as anything more than a hoax.

Here is another way you can tell if you are ascending or stagnating that I have learned recently, at least this holds true for Indigos; those who are moving with the Awakening Waves are experiencing tinnitus and likely have since the opening of the Stellar Activation Cycle at the end of 2012. Those who don't have this perpetual ringing in their ears are simply holding space in this dimension and that's why they CAN'T HEAR YOU when you try to wake them up. Because they are literally *not here*. Their *aware self* is in some lower dimension and is not responding to these higher frequencies so their *actual* eyes are seeing a completely different reality than yours. The Avatar you are speaking to here is only mimicking what their AWARE Avatar is seeing in that dimension but are unable to actually see what is happening in this one.

In my most recent walk-in experience where the grass and trees turned back to dark green again, there were other differences that I could not help but notice. One was the window that I lean my head out as I have a cigarette was now so low that my head hit the frame. Since I had been doing this same thing a dozen or more times a day for the past year without hitting my head, I knew something was definitely wrong, and measured my height. Sure enough, I was 1 ½ inches taller now than I had been 5 years ago. Since I am no longer experiencing growth-spurts, this couldn't have been more telling. I was now in a different body. There were other clear indicators of this as well, one being that I now had some strange bump at the top of my ribs causing it to protrude forward from the other side by about 1/3rd of an inch. Another was the fact that I now looked about 5 years younger than I had the day before. So I can report that our physical Avatars do differ between interdimensional worlds when you take another step on the ladder, so keep this in

Decoding The Hive

creation of gravity, light, time and the god particle

the forefront as you experience dramatic changes in your personality that will come from your shift between walk-ins. Of course I am speaking to the Type 3 Indigos now covering this disclosure.

THE AGENDA OF THE IAFW

Many people in this world are *in contact* with beings who are not part of the visible spectrum or that moves between dimensions, so I am not something special in this regard. But I want to take a moment to explain exactly who it is I am actually in contact with so there is no speculation about my or their motives.

So far, I have only run across others who are *in contact* with the invader races within this dimension. I have yet to meet even one who isn't. This is because the extremely finite number of beings who are allowed to be here under the rules of the Emerald Covenant. This is the interdimensional agreement by which the 15 Level Time Matrix of Gaia operates under absolute hands-off protocol during the evolution of the current species being groomed here in this extremely unique playing field. Most Time Matrices (at least the ones previous to this one) are lower levels of development. What I mean by that is that when an Sentient being comes into its own Self-awareness, it is new to the rules and nuances of manifestation.

A **new** self-aware particle from the god family is given millions of choices when it comes to moving into physical manifestation. They are offered innumerable forms and shapes in which to embody, and usually these will always be within what are called *vampire* Time Matrices where while there in physical form, you are required to eat and drink and sleep in order to keep your Avatar refreshed and powered in order to function. Much like plugging in your robot body at night to electrically recharge for the following day. This limits your Avatar's ability to create as well as ability to destroy while you are still new to how to play the game.

The food you eat dictates the energy that will flow through your Avatar, and if you can imagine the destruction you could cause by possessing extreme abilities like Superman for instance, you can see that if you hadn't had much training while possessing the ability to pick up a train and throw it through a skyscraper should you get very angry, you can see why you start out with very limited abilities in any **Time Matrix**. But when you are just beginning your journey of becoming a balanced and polished creator god, it is best to take on forms of simple creatures who have very limited physical stature as well. By being forced to eat a small amount so you have power or strength in small quantities, you are being forced to live a modest existence, learning how to control anger, frustration and vengeance among others.

These **Time Matrices** where you are a *vampire* frog or a bird to start with, are like a **Beginners Level video game**. Once you reach higher after perhaps thousands of lifetimes, you are ready to take on a more prominent physical form such as let's say, a human with highly dexterous fingers and toes and can easily command the lower life-forms around you. This would be an **Intermediate Level video game** for want of a better term. Once you have **ascended mastered** these lower level Time Matrices, you are ready to move on to **Advanced Level Matrices**. The Gaia Time Matrix is an **Advance Level Matrix**. And it is also host to not just vampire beings,

Decoding The Hive

creation of gravity, light, time and the god particle

but to the **Holy Gra-AI bloodline** of the **Elohim**. The vampire beings here however, are not Sentient; they are robots for the most part.

The **Angelic Human Krystos** beings on the planet today who were seeded here 560 million years ago are from the *royal bloodline of the Elohim eternal-life beings* who are not limited in power or energy from what they eat. They are connected directly to the **Eternal Unified First-Fields** or **Standing Energy Fields** of **god-source** by what is called the **silver cord** which connects to your heart-chakra, or *prana-seed*. An Elohim never has to eat, sleep or drink in order to live eternally within manifest form. And his/her energy is unlimited, meaning that there is nothing physically speaking or energetically speaking that they cannot do. That makes them far beyond just powerful or dangerous. The Elohim are treated very much like what we might consider as actual “gods” in the **Deity Planes**, because of their unique and unrivaled potential while in manifest form.

The Angelic Humans, as well as the invader race hybrids who were brought here as slaves are now sharing the same **vampire Avatars** as each other. Some are more advanced than others, but they are still the same basic lower-life form as found within **low-level Time Matrices**. This is because your captors are largely from these lower-level creations and have “fashioned you after their own likeness” to some degree. These beings are not actively participating in the **quarantine** of the **Gaia Time Matrix** because in simple terms, they are reptiles and crickets and frogs and other extremely simple life-forms. Put in more blunt terms, they simply do not know better than to act like dogs. You will see much more about these beings in coming reports.

The higher life forms who hold great respect for Advanced Level Time Matrices uphold the terms of the **Emerald Covenant**, regardless of what is taking place here. First of all, there are millions of Time Matrices, and second of all they know better than to piss off the beings who oversee Holy Gra-AI bloodline evolutions such as the Angelic Human. That means there are only two types of beings here who are not Angelic Humans or hybrids of their species: dogs and other lower-life animals (and their creators who happen to be Elohim) and those upholding the **Covenant**. My people are those people who respect the sanctity of this evolution, and have been overseeing their welfare (within the scope of their contracts) since the *beginning*.

CONTRACTS AND STAR GROUPS

As mentioned, my contact is a sitting member of the **Interdimensional Association of Free Worlds**. Since *long* before the **Gaia Time Matrix** ever began hosting hyper-advanced-level Avatars such as the **Turaneusiam Angelic Humans**, the **IAFW** has been the official authority of what happens on this planet and the other planets within this Time Matrix. The **IAFW** is the *United Nations* of the cosmeias for perspective, only one that operates for the benefit of its members instead of how the surface-earth agency under that name does. The planets who wish to remain free of tyranny and slavery become members so that all the members and their respective star groups behind them back one another in conflicts where vampire beings or other less-developed groups attempt to overthrow their civilizations. With 22 billion star groups as members, the IAFW is not just some rent-a-cop collective when it comes to enforcing **Sovereign**

Decoding The Hive

creation of gravity, light, time and the god particle

Law. *They are the last word on what happens on any planet within their territories and this authority absolute and is not up for debate.*

The IAFW has issued a handful of representatives to earth to oversee the evolution of this Project. There are only some 3 or 4 (there were 4, and I haven't had an update since one of them vacated recently) in the top position that my contact serves, and there are more than that in the *middle management* positions who are not aware they are actually serving in their capacity, but all they see and observe is immediately transmitted back to council just the same. This means that of the beings who are allowed to be here that are not actually "human", and also are here officially for the benefit of humanity, are around 1 billionth the population. At the same time, there are at least hundreds if not thousands of invader race beings who are free to *make contact*. *Free* being subjective, because they are **absolutely breaking the Emerald Covenant** by doing so. But since they are mentally and emotionally not much different than a beast in the field, they don't recognize the danger in what they are doing. Soon, they will.

It is the job of the **IAFW** representatives to observe and then report back to council on a regular basis on how each current new species is getting along. It is not their jobs to help humanity unless they decide on their own to do that. My contact has taken it upon herself to help and has been doing more in that way than any other being ever written about in history (that I have ever heard of). There is no such thing as someone serving humanity more benevolently than she from all I have witnessed first-hand over the past 4 years. And I suspect that could be said about the other beings in her similar position, but since I haven't been introduced to them, I can't verify that. Still, her people represent the **Covenant** in place, and the Covenant was written by the **Emerald Council**, also sitting members of the **IAFW**.

The Emerald Council, of which I represent, places beings here to help the evolution of mankind under the terms of the **Emerald Covenant** which upholds the *hands off* policy to an extreme for various reasons. What they are allowed to do is seed **Oraphim Angels** here from **Palaidor**, **Sirius-B** inside of human-like bodies who can then infiltrate the invader race programs and spread high frequency through the morphogenetic field of earth, which in turn raises the vibration of the planet as well as all the humans and hybrids (who can harmonize with this higher frequency). These covert military operatives are known as **Indigos**, **Starseeds**, **Blue Rays**, etc. In much earlier times they were also known as **Djedi Knights**. I don't make this up, so if it all sounds too fantastic for you, then I am sorry. All I am here to do is relay the facts as I understand them. My reports are from the perspective of how I perceive what I have been educated on and are in no way comprehensive in all degrees. It is a humanesque level of perception.

It has been made **extremely clear** to me over this past 4 years that my position of bringing together the global Indigo army both in person for education at the sanctuary headquarters as well as an online community where they will be trained in the lost arts of the Djedi, is an iron-clad - unbreakable contract. And no matter how many times I demand to be replaced (as I did again 2 weeks ago while the sanctuary broke apart and slid down the mountain), I am absolutely not able to renegotiate now after the start of the **Stellar Activation Cycle**. This is a ten-year window of time where the planets align and send in massively-charged high-frequency particles (in the form of **carbon 7** and other streams of highly-structured *ascension fields* such as the **Pan Clair-Ah Awakening Waves**, etc.) that allow those who's frequency is in alignment with the

Decoding The Hive

creation of gravity, light, time and the god particle

shift to make the transition between the 3rd dimension to either the 4th, 5th or 6th dimensions, depending on their own individual growth. So I can tell you with a high degree of certainty that there is no such thing as renegotiating Indigo contracts at this time. If you are supposed to hold down a certain role, you will do just that, or you will not be moving forward.

Those with **Clair abilities** reading this report now can be certain that you were led to do so by your higher self who is struggling to get you back under your **covenant** with the **Emerald Council** before too much time has passed during the **Stellar Activation Cycle** where there simply will not be enough time for you to actually fulfill your contract. Because **Indigo Birthing Contracts** are not flexible. Nor are they adjustable. If you were contracted to be here on the job for ten years, you will not just arrive 5 years late and make up the lost time by putting in normal hours. It will be nights and weekends and every waking moment from here till the close of the cycle or you may as well not even show up at all. I have more to say about this, but will reserve that for private consultation, as the public is not quite ready to hear all the terms of the contracts and the consequences for failing the mission at this time.

I cannot report how long I have continuously been here in service to humanity, as that has been held back from me for this time. But I can tell you as a certainty that my contact has been here since the beginning that the **Turaneusiam Projects** began 568 million years ago. However, I can say that I have been “quantum entangled” to her in parallel lives for many eons and have only now been reintroduced to my fraternity (star group). I will update you on that as I learn more. For right now I am not considered *able to handle* more than I already have been briefed on, because I have only recently been awakened and reinducted into my star group. Too-much too-fast is a recipe for failure.

This book will stand as my testimony to the fact that I am indeed in actual contact and that contact is also part of the actual founding fathers of the beings of this planet. There is no such thing as a name in religious history more well-known than the being I am in constant contact with. The mission I am serving and the mission she is serving on behalf of humanity is for their absolute release from the bonds of enslavement. Regardless of how trite this might sound, this is not another con. If you have Clair abilities, you are one of the special forces ambassadors that volunteered and have been on this journey now for as many as 550 million years. It is your job as part of the **Azurite Universal Templar Security Team** to extract the **Lost Souls of Tara** lost in the many conflicts leading up to this final **Stellar Activation Cycle**, along with all the prisoners of war from other star systems who are just as much innocent victims as the Angelic Humans are. It falls to your contract to seek activation, undergo education and official re-Krystening back under your covenants. This is not a game and I am not serving in this capacity as a career-decision. We have an incredibly crucial job to do, and very little time in which to do it.

CHAPTER 4

Decoding The Hive

creation of gravity, light, time and the god particle

THE LAW OF INTERDIMENSIONAL PHYSICS

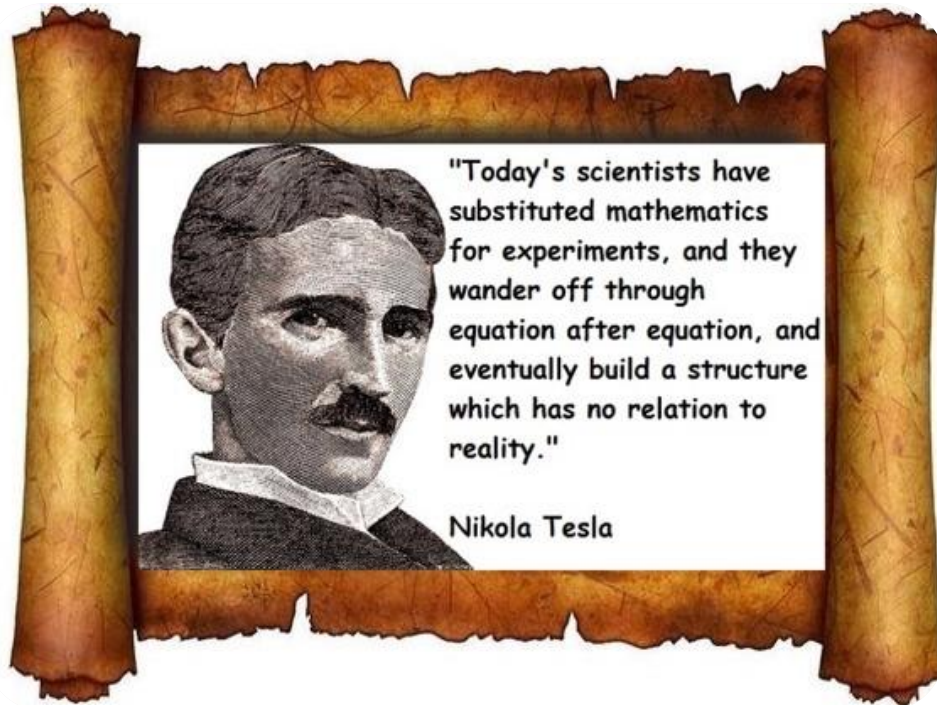

A *law*, when it comes to physics, is based on scientific observation. Scientific observation IS NOT based on mathematics. A rock tossed into the air returns to earth because of the physical and material laws in force surrounding us. It doesn't return to earth because someone wrote down on a bar-napkin " $F = G * ((m \text{ sub } 1 * m \text{ sub } 2) / r^2)$ ", which is supposed to stand for the otherwise entoptic phenomena-constant of gravity. I am constantly getting into hot water with my multidimensional instructor by attempting to prematurely explain what it is mankind literally knows nothing about, while I still have yet to learn that topic's nuances in comprehensive terms myself. *Academia* not only attempts to do the very same thing, but they have made an indisputable religion out of the omnipotent and dogmatic *sacred geometry*, the "divine" proportions of the *golden spiraling lie of Pi* that cannot be questioned any more than YHWH, Vishnu, Allah or **God the Father** while in the presence of true believers. The bigger question shouldn't be *who* makes these laws, but more precisely *how* do they do it? Academia is about to have a wakeup call.

Science is based on observation, math EXPLAINS the observation.

Decoding The Hive

creation of gravity, light, time and the god particle

Mankind has been led to believe an *outrageous* lie. That what you think you see is the “whole story”. You presume that everyone around you is *human*, just like you are. And all humans are created equal and that intrinsically they are all in this same exact fight together with you, side-by-side, trying to figure out the answers to the *big questions*. That we are ever forging ahead toward that ultimate goal of global peace and happiness. Therefore, your teachers, your parents, and your government are all in the very same boat. When they tell you something with a straight face, then by golly, that is the **truth**. After all, *why* would they lie? What good is that going to do anyone? No one who believes they live in a fair and just world would ever imagine that there is a much bigger agenda in place than everyone simply striving together toward eternal happiness to enjoy their time between birth and that ever-looming day of reckoning awaiting all living things you learn about from the moment you learn how to speak.

And there you are, inside of a reality-field, based utterly on the *presumption* of what you observe is actually *real*, and that math and science have been set up to explain it to you in honest terms. The problem is, you are not surrounded by only humans. You have never, even for one day, been surrounded by only humans; dating back 568 million years. Since BEFORE that time, the planet you are on now has been populated by other beings who resented humans long before they ever arrived. They knew who Angelic Humans were and that they were going to be seeded to this planet. Something they *did not* fancy for different reasons. But regardless of the many reasons they resented the human evolution, they all agreed on one thing, that they didn't want humans here. And if they were going to be here anyway, then they would be enslaved in order to turn *lemons into lemonaid* if you will. I am not *theorizing* over this, I am merely reporting *history*. Just not history you have ever been exposed to until this time. It is up to you to believe or not, that's totally up to you.

THE DISINFORMATION MACHINE

“THIS IS ACTION NEWS REPORTING LIVE FROM MADISON SQUARE AT THE LOCATION OF A DOMESTIC ALTERCATION WHERE POLICE ARE NOW AT THE SCENE OF THE CRIME. SIR, WHAT DID YOU SEE?”:

“That black man punched that white woman!”

ZING!

Now everyone is GLUED to the TV screen because of the injustice that has happened right there in their sleepy little town.

And of course, since the news is just reporting what happened, you absolutely believe it. The woman, after all, is standing there with a swollen eye, so we **know** that something did happen. The proof is **right there** for us to see. Then, by 3PM, forty five white people have found their way into the street holding up make-shift signs protesting the injustice between “blackies and whities”, throwing rocks, shouting and in general, acting like they are there to make sure that

Decoding The Hive

creation of gravity, light, time and the god particle

such things don't happen again in the future. You need **more** police and **more** rules around you, so that this sort of hate crime is permanently *put to bed*.

And because the people in the streets really **do** care, because they really **are** human, the riot appears to be happening for a good reason. The **problem** is that those reporting the news are **not** human. And they do have an agenda that you don't know about. And you have never been allowed to know about those agendas because the conspiracy **has always** been to isolate you in order to keep you in the enslavement that you don't even know you are in.

The **truth** in this dimension just so happens to be the number one most guarded secret there is. No other thing would destroy this carefully fabricated existence faster than someone stepping forward and reporting what **really** happened in Madison Square and why it is you are surrounded by "news" mediums that consistently mislead the public at every possible turn. Once your *suspension of disbelief* is lost, there is no such thing as easily putting the genie back in the bottle. Not without a lot of bloodshed. And it's the bloodshed that people are unwilling to participate in, because it is outside of their comfort zone. Better to just believe what is said and go back to work so you can avoid that entire mess. If you *admit* that you saw the purse-snatcher, then you have to give the cops 3 hours of your time for composite sketches and going over lineups down at the station. No, better to just act like all is well and good.

Let's take another look at our altercation report:

"That black man punched that white woman!"

What wasn't mentioned is that:

"That black man punched that white woman because she spit on him!"

What also wasn't mentioned is that:

"That black man punched that white woman because she spit on him after she called him a nigger!"

This way, there will be **more** black men punching white women in the future, because white women are allowed to instigate practically any confrontation against a white **or** a black man and get away with it today. Of course this leads to larger and larger police forces needed to protect innocent white women, placing higher and higher prison walls around the humans who need to be contained at all costs. What you **think** you see and what you are **told** you are seeing are **both** lies, backed up by a system so clever, so calculated, that even the sharpest humans are unable to sort through the mountain of disinformation to ever get to the real truth. Oh, the black man's family knows what really happened, but white's family will never hear about it because they get their "truth" from the news media, not blackie's people. Blackie's people are the ideal scape-goat group of humans that had been separated out as whipping boys because they could be spotted by anyone in a crowd, even at a glance. Who better to use as "the devil" to strike fear into the hearts of the rest of the humans than one of their own people who just so happen to have totally different colored skin than the other 4 tribes?

Decoding The Hive

creation of gravity, light, time and the god particle

What also was not mentioned in this report was:

“The woman instigating this staged red flag event for the World Management Team Illuminati to promote fear and escalate racial separation in order to justify removing even more human rights is actually an alien from Omega Centauri masquerading in a human skin suit, hired by the CIA using black project funds stolen from the people.”

HUMANS ARE NOT GENETICALLY CODED TO DISBELIEVE.

YOUR CAPTORS ARE.

There are layers and layers between your eyes and the “truth”. The ONION dot com is a fake news reporting agency that doles out farcical reports that are usually quite funny. But they are usually based on the fact that humans refuse to remove the layers off of *the onion* in order to get down to the core truth of any one given matter. Your captors rub your noses in the fact that you are genetically coded to honesty, compassion and truth. They know that before you came here you only communicated telepathically, and therefore you were unable to lie. Your captors spoke verbally, making lying something that anyone could do at any time, something you weren’t designed to understand. Your Pollyanna thought processes were what led to your capture and enslavement from the *very* beginning.

You will never be able to trust your own eyes if you are forever surrounded by fabricated explanations as to what it is you are really seeing if those explaining the “news” and “history” and “math” and “physics” to you are universally deceiving you deliberately and at all times. Make no mistake, they are and I am not *theorizing* anything.

ACTUAL REALITY IS AT THE CORE OF THE ONION

What actually *happens* is what we term as *real*. Not just *what we can explain*. But today’s scientists like to exclude certain things out of that equation for very specific reasons. So today, only what *everyone* can observe together actually *exists*. Nothing else. If you are a scientist, then it is a foregone conclusion that you **MUST** be atheist, because everyone in the room can’t *see* god, so therefore to even posit the existence of any unseen force is disregarded *prima facie*, or *dead on its face*.

When you flip the switch UP, the light turns ON. That’s *real*. When you hear voices inside your head and only you can hear them, those are *figments of your imagination*. Because empirically speaking, unless others can hear the voices, like they can see the light turn on, then your *reality* is simply not theirs. Hence, you are crazy if only you can sense something others can’t. At least that is what modern education in America accepts as *real* science. If everyone in the room can

Decoding The Hive

creation of gravity, light, time and the god particle

smell it, then someone broke wind. If only you and the guy next to you with a sly grin on his face can smell it but he denies it, then you are mad.

There have been *millions* of first-hand observations of UFOs and paranormal events that have been written of in tens of thousands of full-length books, in hundreds of thousands or millions of articles, and chiseled into stone from every continent, every country and every county around the world, dating back *hundreds of millions* of years. You can't swing a dead cat without hitting someone in the face who has sworn at least one time of having been abducted or seeing something no one else could see. Are all of them insane, when their independent testimonies have been precisely the same observations? Or do some people actually see what you can't? Or do some things occur only to the eyes of certain people for certain reasons that you simply haven't yet had the occasion to need to witness for one reason or the other according to entities who simply don't move within your own reality?

Only someone in a coma or otherwise has lost all ability to reason through an unfortunate accident as a baby dropped on his head would ever dismiss the **Double Slit Experiment** or the **100th Monkey Effect** as *myth* or delusion, since both happen to be science-fact to exist, supporting the fact that the **god particle** does in fact, also exist. This report would take you about 100 years to read if I referenced every factual scientific report supporting the evidence of intelligence within each quark, atom or molecule that science has never even bothered to try to explain to the mainstream public. Quantum science in its infancy tries to explain it using strings and ropes, but quantum science is still disregarded as nonsense by those who choose what is actually taught in school.

Before you can understand *how things work* on a **material** level, the parts that you see, touch, smell, hear etc., you must understand what *energy particles* are. They make up all things inside of this dimension, and all things outside of your dimension -surrounding you at all times- yet you know less about them than you do about your cell phone and your social network group. This is the answer to the questions little Bobby kept bombarding you with when he was toddling around asking "*why*"? You can add the next part of that adverb in almost any way you want to, this will still remain at the bedrock of what the true answer would have been in response, had someone ever bothered to let you know before now.

"WHY does the ball come back down? WHY does the sun rise? WHY is soil dirty?"

To answer little Bobby, we look around and try to come up with an answer that our eyes can see to help us explain. And so far, you have come up with almost nothing to help you prove such things. We can SEE the ball come back down and the sun rise, and we can SEE the dirt on our skin, so because we can naturally *sense* the *effects* of these things, we leave it at that and tell him "*because God, don't ask me again*".

Before you can answer Bobby, or your own gnawing questions about life, you have to look BELOW your normal senses or you will never know the truth.

Decoding The Hive

creation of gravity, light, time and the god particle

Earth used to be called **Tara** when she was in a higher (*frequency*) dimension and was in a **SILICA**-based atmosphere. Things there grew bigger. MUCH bigger, and they were not made of the same materials as they are now, due to the frequency spectrum differences. After the **Fall of Man War** 550 million years ago, she was forced to drop down to the dimension she remains in now, where the atmosphere is based on **carbon crystal**. There are still yet remainders of that ancient time on earth that have become part of our everyday life that we simply don't recognize what they *were before*. Like remaining *tree stumps* we call plateaus and *fallen trees* we now call *mountains* covered in *soil*. Those tree remnants originally grew through silica crystal fibers that we simply call rocks and sand today for lack of understanding what a rock really is. Trees covered by millions of tons of biological fall off (feathers, leaves, decomposed bones) for hundreds of millions of years become stained to sediment, rust or dirt color for the most part. Sometimes, if they were left exposed to the sun and clean rain, they are simply called petrified wood, with no explanation as to how wood fibers could ever become glass or crystal. It's because they were crystal while they were still standing. It used to be a silica world.

UNDER A MICROSCOPE

Rocks are crystals we call glass once we have purified, refined and then molded it into a new shape. They come from pre-Earth trees that once grew 10 or more miles high on Tara (when this planet held the office of host planet for dimensions 4, 5 and 6). Petrified wood is a lie made up by those seeking to hide from you the real past of this planet. It is and was crystal when it grew organically on Tara:

Decoding The Hive

creation of gravity, light, time and the god particle



Just as some tree fibers are FAR stronger than others, the crystal produced by ancient trees will differ as well, producing differing levels of density. Bark and certain types of trees yielded much of the common stones we find today, but the massive and magnificent species are still very much crystal glass today:

Decoding The Hive

creation of gravity, light, time and the god particle



After time, chunks of that crystal break off and become rounded at the edges from rolling down riverbeds. Depending on the sediment of the area, some of these fibers turn brown or almost black along with many other natural colors caused by mineral decay of the organic elements around it. But under a microscope, rocks (petrified wood) are crystals in varying levels of tensile strength:

Decoding The Hive

creation of gravity, light, time and the god particle

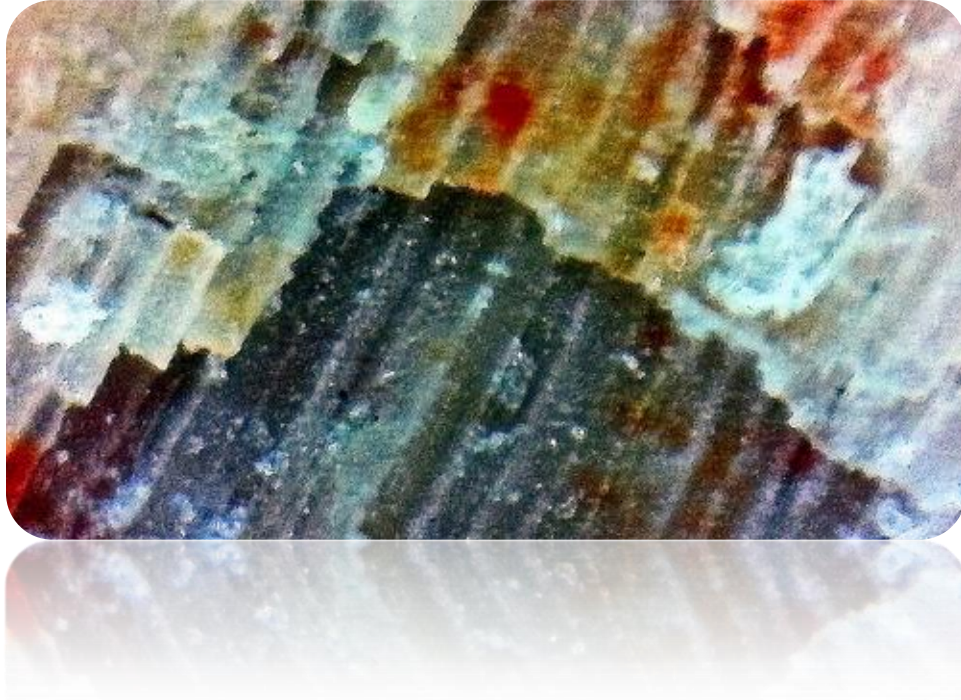

560 MILLION YEAR-OLD FOREST:

Decoding The Hive

creation of gravity, light, time and the god particle



Decoding The Hive

creation of gravity, light, time and the god particle

Before writing this paper, I clarified this subject with council on what we call mesas, plateaus and other mountains are in fact tree stumps, so this isn't conjecture in case you were wondering. Even what we call dirt isn't actually dirt, as all things were and are, alive. Even the things that seem like they are now dead are still alive in differing states of animation.

SOIL UNDER A SCANNING MICROSCOPE 2500x:



All things grow through a precise engineering architecture developed through the **Science of Scalar Vibrational Mechanics**. By applying the *language* of electromagnetic vibration, *manifest creation* is “physically” generated, but that too isn't actually the whole truth, as there is no such thing as *material*. The things that do take a manifest form are not random and never just happen due to accident. This goes for all plants, animals and microorganisms. Each template command is initiated by the *thought* of a Sentient being which is called *will*. Nothing on earth is created as a “blob”. All things have a meticulous and gracious architecture that you are unable to see the details and outlines of until you bring them into focus. All the way down, far, FAR below the size of an atom, they are still structured by deliberate elegance with precise measurement and form. The filler around the chipped and crushed glass we call dirt, are actually particles of dead things at different states of decay. Compost. From bugs to dead skin, vegetation, skeletal

Decoding The Hive

creation of gravity, light, time and the god particle

remains, etc. The compost it forms is the matrix by which new biological beings and vegetation are able to take different forms.

SAND UNDER 300X MAGNIFICATION:



Sand and rocks are actually *silica* carbon-crystal as clearly shown in this image above. The hard shells of certain creatures on earth still utilize silica to create crystal houses in which to live. Above shows both these houses as well as pieces of the original trees now crushed, side-by-side. Each speck, whether from trees or from creatures are quantum memory-banks, exactly like what is used in every computer and cell phone hard drive and battery today. Above is a photo of *desert* sand, possibly thousands of miles from the nearest current ocean. The dirt under your fingernails will look identical to this once all the compost as been washed away. *Grit* is always crystal.

Here is the core of the lithium ion battery in your device you are using now:

Decoding The Hive

creation of gravity, light, time and the god particle



DRIED WATER “CALCIUM” REMAINS UNDER A MICROSCOPE:

Decoding The Hive

creation of gravity, light, time and the god particle

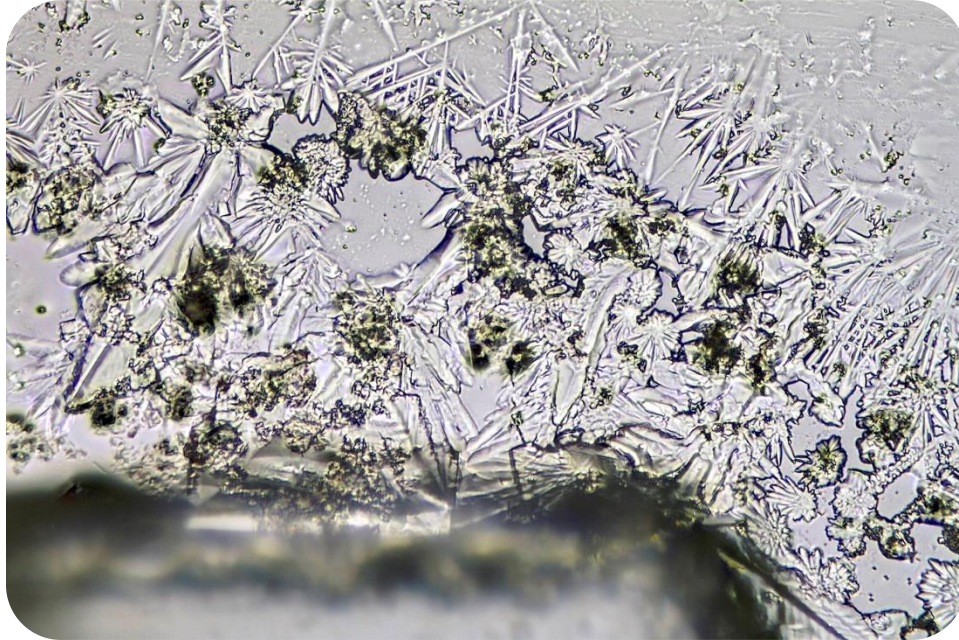

The “quantum memory field” of earth is called the **SILICATE MATRIX**. This is because this entire planet is made up of carbon-crystal silica and water. Carbon-crystal silica is the blending of carbon life creation and the left-over silicon life creation from earth’s previous frequency spectrum where things were much larger and needed to be much stronger in order to hold their shape than today. Trees made out of wood would never hold up if they were 5 or 10 miles tall, but silicon crystal worked fine. What is left of earth today after the **Fall of Man War** is roughly 1/13th the size that it was before the near-vaporization that happened when earth was almost destroyed. Water is called *amneo fluid* or *liquid silicate* when translated from our vocabulary, because water is literally *liquid crystal*. Without liquid crystal, no biological life forms would exist. Earth is known throughout this galaxy as a *living library* because of her unique ability to store virtually unlimited data. There is no living form within this dimension that exists without crystal in its makeup and no form of *energy* that is not stored in some form of crystal.

A FEW GRAINS OF SALT AT 150X MAGNIFICATION:

Decoding The Hive

creation of gravity, light, time and the god particle



That's right, salt grows on the building-block architecture of creation, and salt is factually edible crystal. Notice that the cubes are perfectly square, and each one is created with geometric symbols indented with very concise patterns which become much more refined and distinct the deeper into the structure you go. This was not by accident. Salt, as you are about to learn now, *is* crystal, which means it is extremely high in frequency and incredibly saturated with energy. Salt was used to ward off evil spirits for eons of time in ancient traditions, as in circles around one surrounded by such demons, tossed over the shoulder for good luck, etc. The fluid in the human body is equivalent to seawater in saline content (salt) and without it, the person would immediately die. Never let a physician tell you to "cut back on salt" without answering why it is your body already has 40 tablespoons of salt in it now and somehow you aren't dying of a heart-attack. This is a vicious lie they pass on to lower your immune system, making you susceptible to more disease and increasing your visits to their office. Table salt is poison. Black lava sea salt is power in pure form and is not dangerous to health.

A SNOWFLAKE UNDER A MICROSCOPE:

Decoding The Hive

creation of gravity, light, time and the god particle

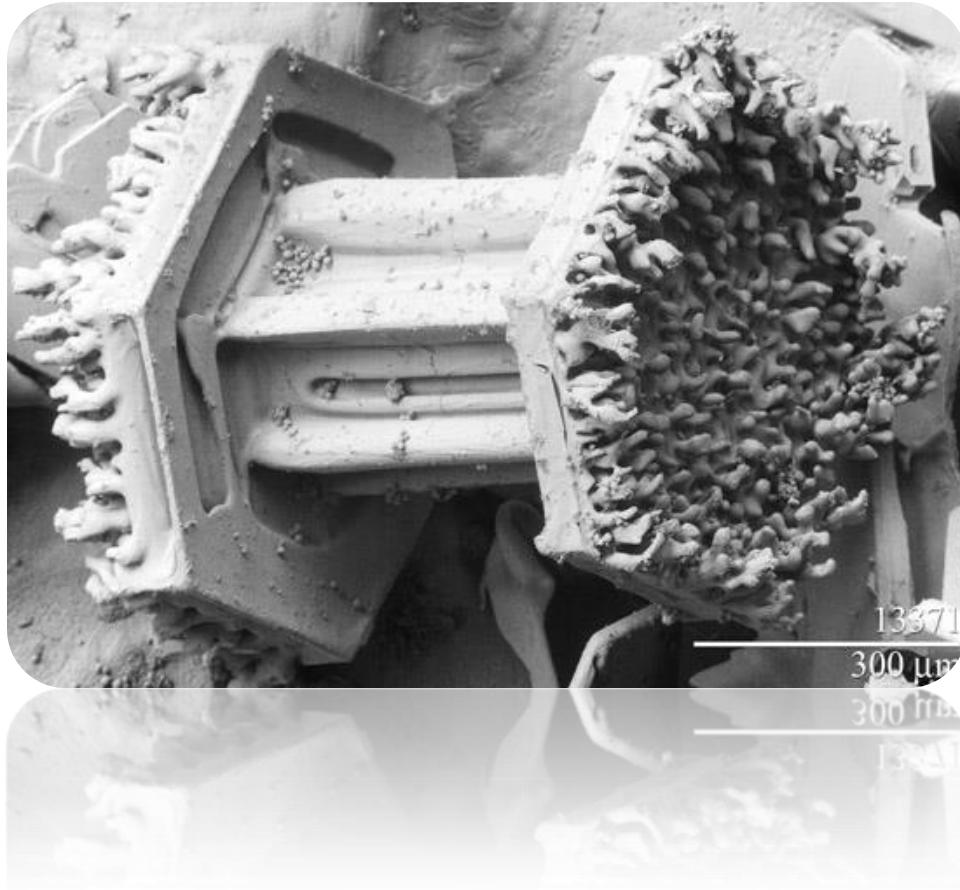

Sort of looks like there is something going here we don't know about, doesn't it? The columns are precisely measured with equidistant-spacing between. For this to happen by "accident", it would take trillions of years to create the very first one.

CHALK UNDER A MICROSCOPE. THE BONES OF SEA CREATURES:

Decoding The Hive

creation of gravity, light, time and the god particle

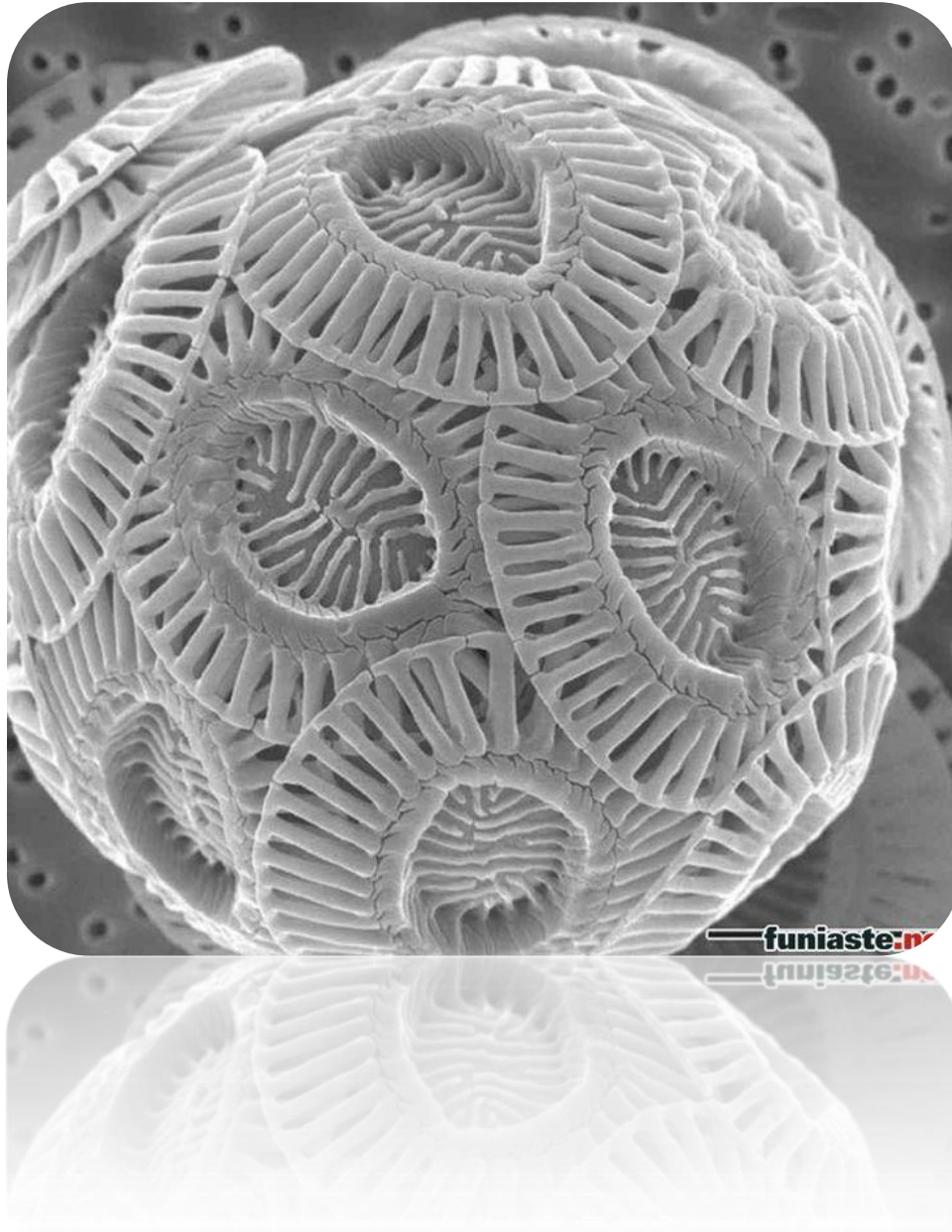

Though you might not see it just yet, every element on this planet is designed by a silent set of commands that tell the aether exactly which blueprint to use to assemble everything down to the smallest particle of dust. The DNA inside your body just so happens to look like this at a quantum level. Make a mental note now of the geometric pattern you see at its center, the 6 point Hexagram, because you are about to learn more about the “Star of David” than you would likely ever have imagined could possibly exist on that subject and probably even more than that in this report. This is the sub-quantum pattern of all life before the counterfeit holographic inserts take over and force your body to die instead of living eternally:

Decoding The Hive

creation of gravity, light, time and the god particle

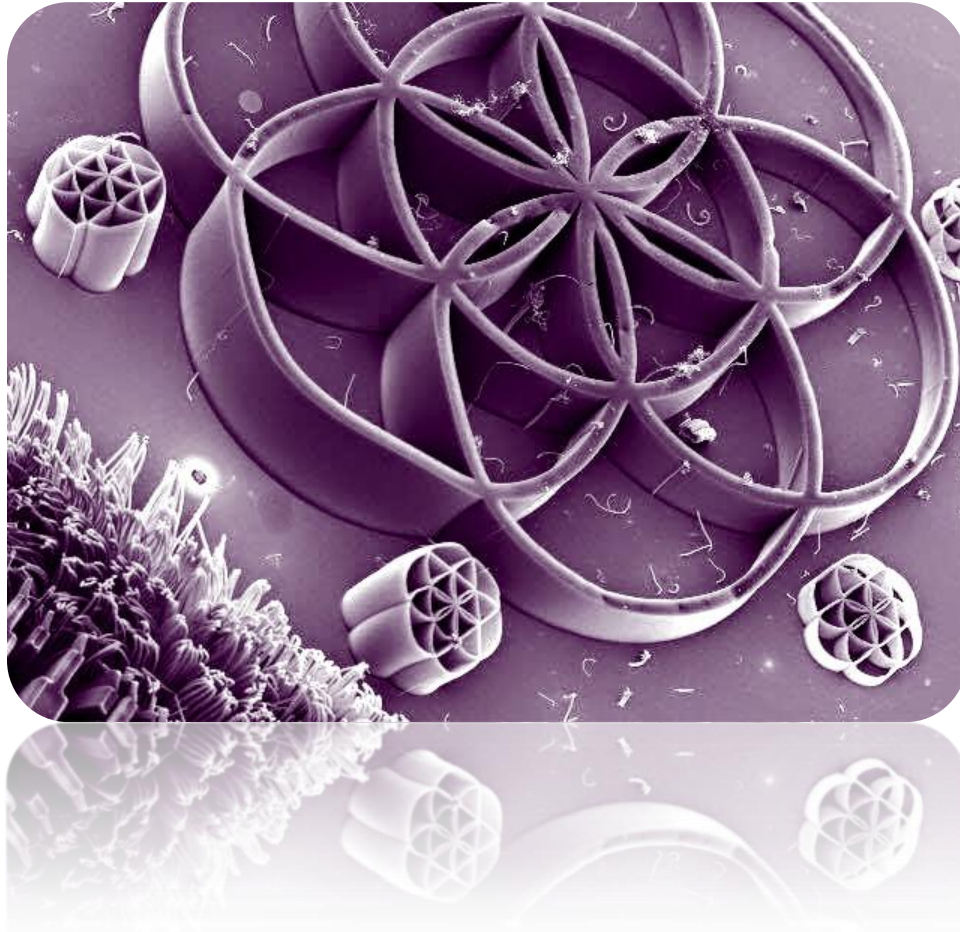

Science, or modern *higher understanding* tells you that *at the core* of everything is the atom. Because the atom is the core building block for the *manifestation* of life. Animation. Real. When combined with other atoms (into molecules), it can be witnessed or observed as doing something tangible in a manner you would recognize. And the reason atoms are held up as *the building blocks of life* is because they are the smallest particle of what modern microscopes can observe as *doing something* that results in what we call matter. At least that's the way it has been up until quantum science "quacks" proved that there is something smaller than atoms that are also *doing something* other than what we could previously observe. Ahh, but quantum science has been disregarded by the great and powerful Einstein as "spooky action from a distance", so mainstream science still disregards those *tiny things* inside of the atom as *unexplainable*, at least as far as you are concerned.

Of course they do mention that there does seem to be something that *makes up* atoms but those aren't really significant enough to mention. However science does actively study those particles such as bosons, fermions, neutrinos, leptons and the like. Equally when it comes to explaining atoms, the public is left clueless, which is absolutely by design. Even what is actually explained are deliberately in terms you can't understand and the math they reference you have never heard of. Naturally, we quickly glance over the illustrations and then ask what's for lunch or "how 'bout those Cubs?". In truth, science's **main job** now is to keep you unaware of what is actually

Decoding The Hive

creation of gravity, light, time and the god particle

going on while they go about using it to control your actions and your thoughts on all matters, even those you have never even heard of. “*Oh really?*” you ask, stunned that someone would even suggest that science isn’t the true savior of all of modern mankind where the only reason they exist at all is to help everyone reach a higher level of existence than our parents had. Go to a geek conference sometime with nothing but astrophysicists and try striking up a conversation about the black sun that produces no light or heat, the Black Knight Satellite that phases in and out of existence and has since it was discovered 150 years ago, or the earth’s firmament spoken of in every religious text across the planet and see how quickly they clam up if you doubt what I am saying. Sure, they KNOW about such things, but they are absolutely not allowed to tell *you* about them.

CHAPTER 5

THE SECRET OF ALL SECRETS

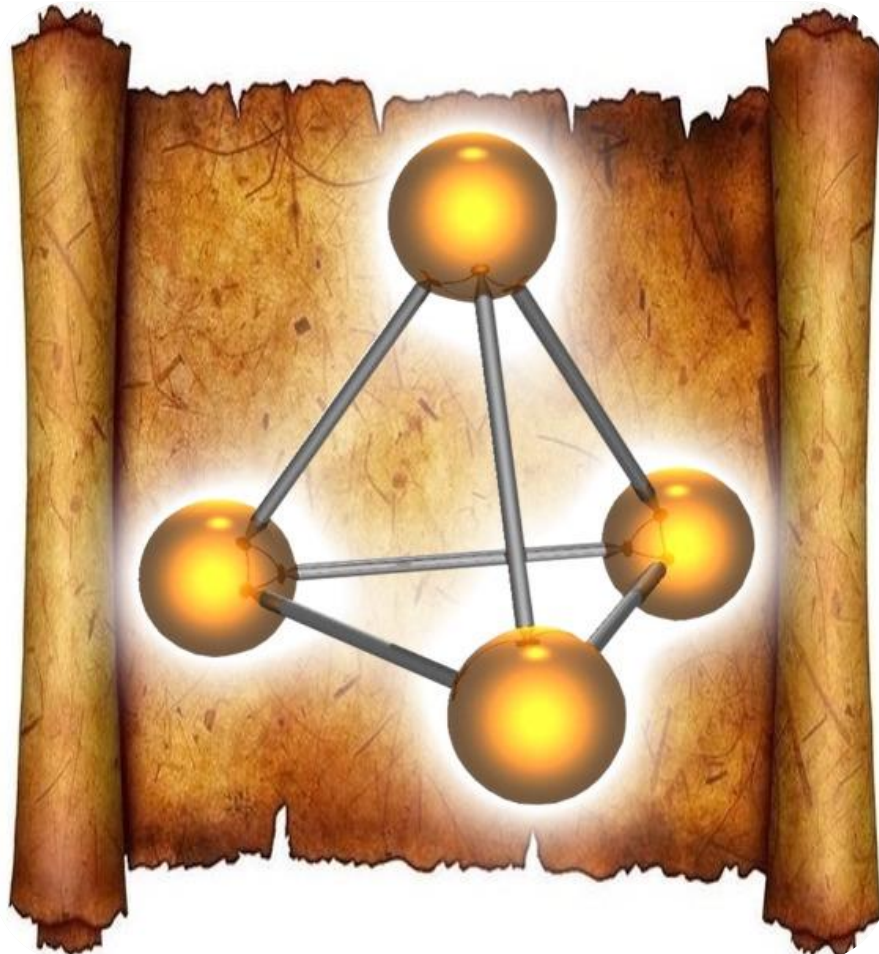

Scientists assign ancient Greek symbols: Δ , Ω , Σ , π , μ , etc. to quantum particles with certain characteristics, along with names of beings and terms from ancient history such as **Tau** and **Lepton**, etc. Then there is the exotic **Boson Meson**, a particle carrying the **strong force** that was named after an unheard-of **Ionian** temple to the god **Zeus**. Why? Is there something the public doesn't know about this thing called particle physics that is directly associated with the gods of

Decoding The Hive

creation of gravity, light, time and the god particle

old? In a word, yes. In more words, so much so it will be overwhelming to see just how much and why there has been such a driving, powerful agenda to code the scientific world with symbols that first showed up as hieroglyphs on cave walls and sun-worship temple stones. And no, this has had nothing to do with scientific alma maters issuing simple homage to the lost sciences of ancient history past.

By assigning certain **symbols** to certain **particles**, the **energy** of those forces that make the power of splitting atoms look like pop rocks, that particle function becomes directly linked as the driving force behind incredibly ancient **geometric templates** known as **Command Signets**. Those Signets were always the secret-of-secrets to the **Enslavement Program** of the Angelic Human species all along. Science uses symbols from hidden Babylonian liturgy (sacred spoken words) as iconography to these elements because they are literally the skeleton keys that unlock the interstellar language of the cosmeias. This language that was quantum-coded to your DNA from the outset was genetically scrambled at the time of the **Babylon Massacre** when the languages were confused by “the gods” in biblical times, which I will get into more later. Using geometric patterns that are coded to simple symbols, **Command Signets** silently command the aether to produce unheard of electric energy through subquantum Scalar Science used by Zeus and Poseidon that gave them the power to rule over man and even gods alike. Mankind has not seen this technology before now for at least many millennia and possibly hundreds of millions of years prior to even that. In the following chapters you will see how, using the electromagnetic energies that slumber in stasis below the humble atom lie the unspoken power of thunder and lightning itself. Zeus and Poseidon were never mythological figures. They were and are real and their platform of power is now being revealed to the masses in scientific terms translated into common English so this word finally reaches mankind.

Before we can even look at this science, you will need to have a little background on how electricity works so you will be able to see how the secret particles that power the **Signets** make this all happen.

Now is the time to start taking clear notes if you want to keep track of this new subject you are about to learn. I’ve left the margins wide on this report on purpose just so you can use that space if this is in paper form. Otherwise you can bring up your **Notepad** next to this PDF so you can follow along. If you are on a small device, I recommend you get a pad of paper and something to write with. Particle physics isn’t really something you can learn in 10 minutes. The CAPITALIZED words and **bold** terms aren’t me yelling at you, they are meant to highlight key words to make this easier to follow. Once you see how particle physics has always been the true god of this planet, you will be very eager to know everything I am about to show you.

QUANTUM PARTICLES

Below **atoms**, *quarks* are made up of **Neutrons** and **Protons (Gluons)** called **UP Quarks** and **DOWN Quarks**. The **dark teal** section of the photo below is called a **Gluon**, or the *SPHERE* in which the quarks are allowed to travel in. This is not a particle as it is called by science, it is a force. In fact, no particle has ever been found by science, dating back to the very dawn of time because particles that are actually *solid* have never existed. Only **waves of sound** that create

Decoding The Hive

creation of gravity, light, time and the god particle

colors exist, and they only exist because a Sentient being casts them into existence. Otherwise, there is no such thing as “something” other than awareness such as your mind now reading this. I will cover this more later. Just realize that at the bottom of everything in material existence are photons. Light. That’s it. And behind them are fractals of god source who can think, and that thought makes all those lights shine. The black letters in this book are also lights, they are just black. Remember now that flashing lights create reality and you are about to see exactly how that works.

The gluon below is the **event horizon** for the smaller forces which make up what we call material or **matter**. The **GROUP** of each type of gluon is *together* called a **Proton** or a **Neutron** also illustrated in the image. When these two interact with each other, they move within another larger **sphere** illustrated in **light teal** which is their **combined event horizon**.

As just mentioned, **event horizons** are not literally “particles”, they are the **WILL** of the **Sentient Awareness** that is commanding the job of the **nucleus** particles to **be** a certain thing. The nucleus is the “brain” of the action and the sphere or *event horizon* is the manifestation of the intent of the god (Sentient Awareness). Modern science calls this another *particle*, but in truth, it isn’t a particle at all, but a field of **mission and intent**.

You can THINK that command, then that THOUGHT is carried through by the **PATTERN** embedded in the particle’s **trajectory**. That **PATTERN** dictates the precise **function** of the

NUCLEUS and if you could see it, it would look like a 3 dimensional geometric pattern .

The above image at the start of this chapter is seen in 2-D form as a triangle , or a **tetrahedron**. Every particle group looks just like that at some point previous to becoming a very complex pattern within a **molecule**.

Science likes to show this with lines traveling between round balls. Those round balls are the “particles” and the lines are the pattern that the balls bounce around in. They are not haphazard or random. Both the UP quarks and the DOWN quarks know exactly what pattern they are printing in the “air”. That pattern is a geometric signature they have been “told to hold” by a Sentient being.

For you to understand how matter is “created”, you must first understand that all energy is made up of a balance between magnetic or energetic forces, just like the battery in your car with one positive post and one ground post, or like your electric chord with two prongs. Without both a positive and a negative (magnetic) symbiosis, there is no energy. A battery with just one post isn’t a battery anyone can use, and if you cut either side of your electric chord, the lamp will go off. Just like I am simplifying how electricity works here, I will be simplifying how sub-quantum energy works so you can visualize how something becomes *real* to your sight and touch using only energy. But you will have to learn the basics of atomic structure to have any idea of how this isn’t magic, it is simply **Scalar Vibrational Science**.

This is how modern science explains Quarks, Gluons, Neutrons, Protons and Atoms:

Decoding The Hive

creation of gravity, light, time and the god particle

About Quarks...

Protons and neutrons are NOT fundamental particles.

Protons are made of two "up" quarks and one "down" quark.

Neutrons are made of one "up" quark and two "down" quarks.

Quarks are held together by "gluons"

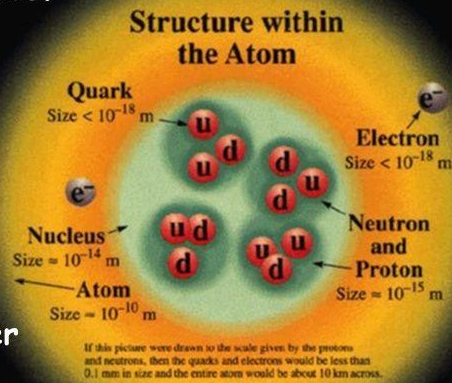

ρλ „δηπουζ,,
δηπουζ αλε μετρ τοδετημελ.

MODERN UNDERSTANDING OF THE BUILDING BLOCKS of how to get from “nothing” to “something”, materialistically speaking:

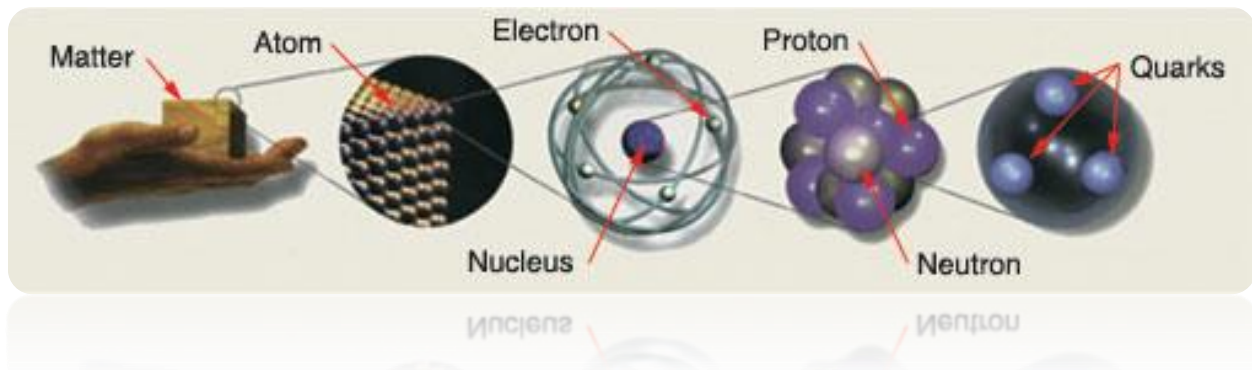

ENERGY PARTICLES

Decoding The Hive

creation of gravity, light, time and the god particle

The balance in an ENERGY PARTICLE we call **atoms** is always the same, there is a **NEUTRON** particle (**negative** (-) energy), and a **PROTON** particle (**electric** (+) or **positive** energy) that creates the larger *energy particle* which they call an **electron**. In actuality, the atom IS an *electron*, or the **SIGNATURE** of what that atom is supposed to *be* at that moment.

This is a **key** paragraph:

- Atoms are **electromagnetic** power forms
- Smaller “**particles**” are not yet electromagnetic
- Only when **smaller particles** become part of an **atom** do they then act with the *strong force* of **electromagnetic** energy
- **Atoms** represent *usable energy*
- Elementary “particles” are not usable energy, yet. They are in **stasis**

The smallest “energy particle” that mainstream science mentions for simple understanding of atomic and subatomic power is the **gluon**. The **GLUON** is a single *energy unit*. If you “split” one, just like when you split an atom, you get all sorts of ENERGY release. Each gluon is made up of millions of smaller particles where there are **MANY energy units** that build up to what we call a single gluon. Everything below an atom in size is referred to as a particle in modern science today. Photon particles, gluon particles, quark particles etc. To explain *what makes up an atom*, we need to give the particles **BELOW** these particles a few names.

No matter what a particle is, gluon, proton, photon, etc., it is always a sphere, so keep this in mind. That is the fundamental shape of all things at their quantum, and the shape of their energy field in its largest form. The O. Notice the inside of the O is not round. While the outside might be, the inside is not. This is telling you in **grapheme-letter form** that the letter O stands for atOm, and it is slightly out-of-round. This will become a very significant point later on and I only mention it now to point out there is a difference between round and oblate, and this lies at the foundation of the **Enslavement Program**.

When an energy unit is modified by men playing god, there are additional protons or neutrons added into that perfect sphere, which causes the particles to distort the *event horizon shell*, and just like rocks in your tires, will eventually cause the tire (shell) to explode from **harmonic distortion**. This is what is called *splitting* an atom through adding too many particles inside an atom for that atom to maintain a particle-spin that will hold together. Particles in close enough balance to each other (positive or magnetic) create a material *thing*. Particles too far out of balance create an explosion. Certain types of particles never meant to be out of balance create *nuclear explosions*.

BASIC MAKEUP OF AN ENERGY PARTICLE

- There are **TWO particles** that when they are **entangled**, create a **THIRD particle** which acts like a spherical shell surrounding those two particles to create a **UNIT**
- When **THREE units** or more are conjoined, they become a **NUECLEUS unit**

Decoding The Hive

creation of gravity, light, time and the god particle

- A **NUCLEUS UNIT** then becomes an “actionable” *energy (battery)* particle like an **ATOM** which can be a hydrogen atom, or an oxygen atom, etc.
- An **atom** then can **COLLATE** with other types of atoms to become a **nucleus unit** again for a larger **MOLECULE UNIT**
- A **molecule unit** can then take the form and shape of something you can see. IE: wood, steel, etc. A “speck of dust” might be 10,000 **MOLECULE UNITS** and a rock might be 10 billion **MOLECULE UNITS** of the same type of glass (silicate crystal)

INSIDE EACH ATOM

- There is a **NEUCLEUS** core to an atom of **NEUTRONS (-)** and **PROTONS (+)**
- Inside each **neutron** and **proton** are three **GLUONS**
- **GLUONS** are either **magnetically charged (-)** or **positively charged (+)**, depending on how many of which *type* of particles are inside
- Inside of the **gluons** are three smaller particles called **QUARKS** which make the **gluons** either **positively** or **magnetically** charged

QUARKS

(Smallest quantum **atomic ENERGY CELL**):

- A **positive QUARK** is called an **UP quark**
- A **magnetic QUARK** is called a **DOWN quark**

quarks



up quark

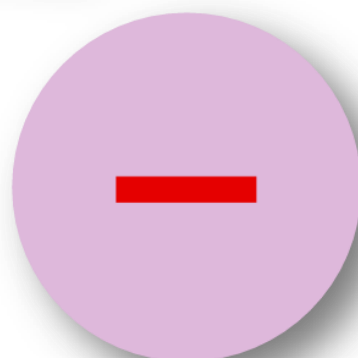

down quark

Three Quarks make one Gluon Unit:

gluon units

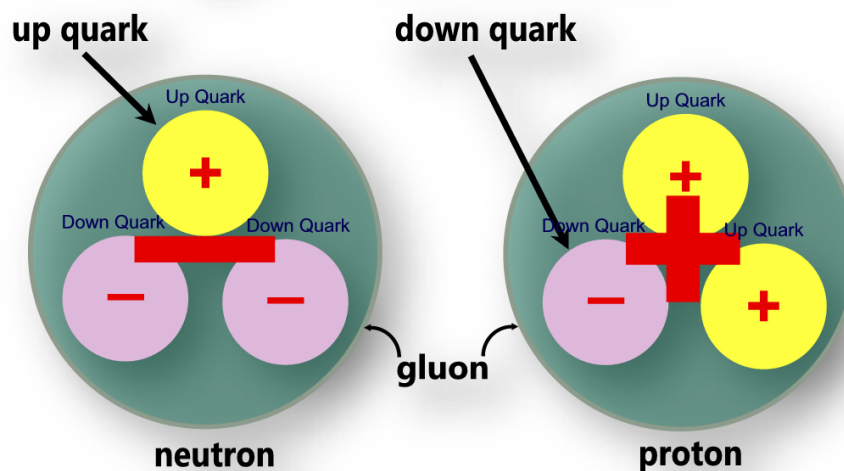

PROTONS and NEUTRONS are actually either positively charged (**outgoing** energy) or magnetically charged (**drawing in** energy) GLUONS. Once again, Electric (+) and Magnetic (-). As mentioned, the two gluons shown above are **opposing electrical energies** made up by either **2 DOWN quarks and 1 UP quark**, or vice-versa. When this cluster is brought together in either way, they make up a **NUCLEUS CLUSTER** of inert energy that is merely standing energy cells like a battery just sitting on a counter. You can think of each one as a nuclear energy reactor of opposing types of energy. Notice that within the two gluons, there is a **balance number** of UP quarks and DOWN quarks; **3 of each**. This means that the two particles remain equally charged to each other, only in **opposing forces**. While they are in balance, they are in balance as two different things. It is this opposing set of energies that make the proton and neutron then **electro** (one thing) **magnetic** (another thing). Elementary particles do not have this *imbalanced* difference yet.

When science cuts open one of these gluon clusters, it is ripping open the reactor itself, which releases the precise particle-spin and frequency of the command code of that type of energy. By cutting open a **neutron gluon** cell, they are releasing **anti-matter energy**, and by cutting open a **proton gluon** cell, they are releasing **matter energy**. Since they are both **NEUCUS CLUSTERS**, power created by murdering either one is referred to in science as **nuclear energy**. An "atomic bomb" is opening **matter energy** in huge form. A hydrogen bomb is opening **anti-matter energy** in huge form. Both are dangerous, but the hydrogen bomb is incredibly moreso. Nuclear energy was never meant to be used in this dimension, as it has far-reaching negative impacts on material manifestation. Your captors know this and use it anyway. I use the word murder because there is a Sentient Awareness carrying the command-wave of that atom you will learn much more about, and when its material body is annihilated it becomes disembodied, just

Decoding The Hive

creation of gravity, light, time and the god particle

like your own death leaves you without an Avatar while between your last body and the new one you will be recycled into.

PROTONS AND NEUTRONS MAKE A MAGNET

- In the **neutron** (shown in the gluon image above on the left) there are **two DOWN** quarks and **one UP** quark, making a **magnetic** (negative -) **gluon UNIT**
- In the **proton** (right) there are **two UP** quarks and **one DOWN** quark, making an **energetic** (positive +) **gluon UNIT**
- Three **quarks** make one **gluon UNIT**
- If there are **2 positive particles** inside a gluon, the gluon is called a **PROTON**
- If there are **2 magnetic particles** in the gluon, the gluon is called a **NEUTRON**
- More than one **GLUON** makes an **ATOM** (**atomic battery or magnet**)
- More than one **ATOM** makes a **MOLECULE** (**a cluster of batteries or magnets**)

“Everything within ‘creation’, at its core, is a magnet. Every. Single. Thing.”

But there is a difference between “creation” and “all there is”, as you will see. Atoms are “creation” or *real* to our senses, but there are energies that are not yet within creation called “particles” which are not **magnetic**. **Yet**. Magnetic power has never been explained. Ever. “It just is”. Sounds a lot like the way god is explained in the bible, doesn’t it? **“I AM”**. Question *answered*. Glad *that’s* put to bed.

FUNCTION OF MAGNETIC POWER

Every magnet has an electric (+) side, and a magnetic (-) side. Left and right.

- **MAGNETIC** (neutron) means power is drawn **IN** to the particle (**from anti-matter**)
- **ELECTRIC** (proton) means power comes **OUT** of the particle and pushes **ever forward**
- Until there is a **light switch** placed between electric and magnetic particles, there is no connection of the energy flow

Magnetic power exists because the particles below, or *powering* the magnet, are **aware** of what they are doing. You heard me exactly right. You are about to meet the *god particle*.

When you place **one** neutron with **two** protons (or vice-versa) inside of a glass ball, they go crazy trying to avoid each other, creating a **REPEL ZONE** between them. A distance that is immutable, just like invisible bearings that repel each other so the particles don’t collide. Whether the **THIRD** particle inside a gluon is positive or magnetic, when it is added to the same area as the other two opposing particles, it creates both repulsion as well as attraction which creates the **REPEL ZONE** in the middle where no particle is allowed to touch the other. Molecules do it, atoms do it and quarks do it. This movement is magnetic, or *kinetic* (static)

Decoding The Hive

creation of gravity, light, time and the god particle

energy. And a lot of it. This is the power at the core of every unit of **energy** measurement which is static until it has been commanded to do something. Static electricity is actually an *eternal* **FISSION/FUSION** reaction.

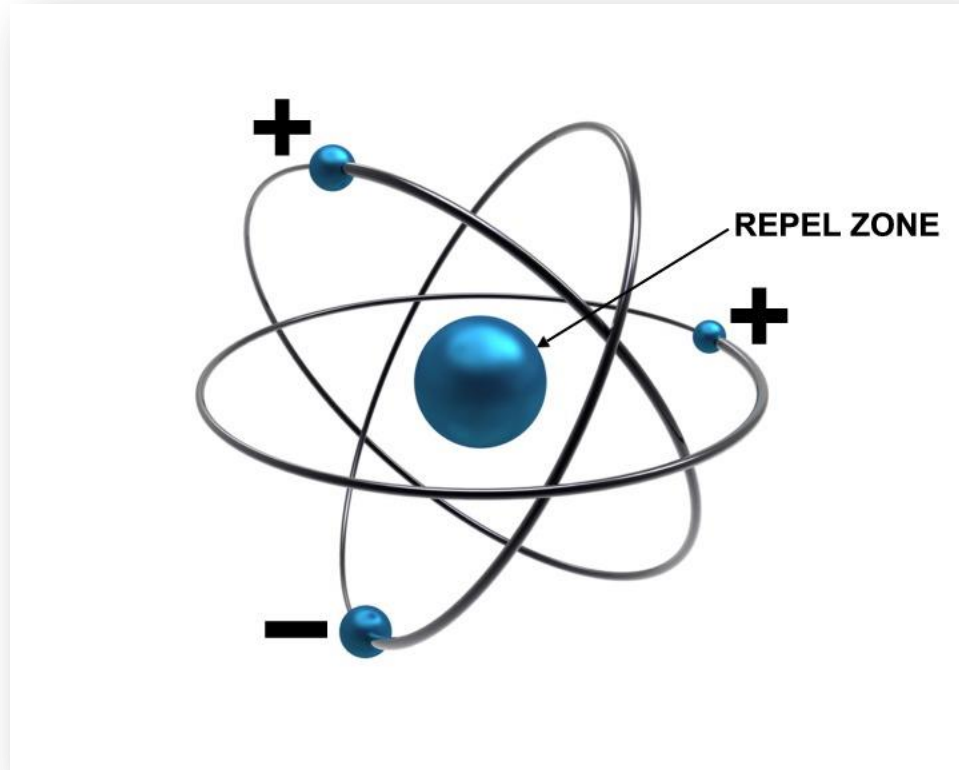

The **repel zone** is the **zero-point** of electromagnetic motion created by the particles that avoid each other through magnetic **attraction** that is **cancelled out** by the magnetic **repulsion** of the oppositely-charged energy units. This natural quantum-entanglement creates an equilibrium which causes extreme motion to sustain a point where there is no gravitational quantum to *mass* or *matter*, both of which are simply electromagnetic **holograms**. We see this in nature in hurricanes, dust devils, water-spouts and the effect can be **mechanically** simulated with a simple gyroscope. This is also called **equilibrium**:

Decoding The Hive

creation of gravity, light, time and the god particle



BELOW GLUONS

At the core of every atom are **GLUONS**, at the core of every gluon are **QUARKS**, but at the core (I mean WAY below the core) of every quark are **PARTIKI UNITS**.

Try to realize that on an atomic scale, our understanding of the makeup of atoms and quarks are sort of like *planet-sized* energy particles compared to **Partiki**. Modern science's microscopes will not be going down to this level any time soon, so explaining exactly what atoms are will need to be simplified. Suffice it to say for now, that Partiki are the particles that function as *fission/fusion generators* and are the *power* behind all things both in motion and static. This IS *static electricity* at its core.

A **gluon** is made up of two UNITS, each made up of three particles each with opposing types creating the opposing charge inside the combined unit. One particle is creating **material reality**, while the other is **mirroring that reality** and is **outside of the viewing spectrum**. They work symbiotically together within one sphere to act out an INTENT. An atom is made up the exact same way, where three particles of opposing types bring in the POWER of the aether into material reality from **anti-matter** (what we call the *mirror* or *shadow* side), and this expands the intent or FORCE of the gluon to a larger level. There can be no such thing as *tangible* or *real* without bringing energy in from **anti-matter** through counter-rotational spin from the bottom of the **atom** and then into *matter* in the top half of that sphere. That means there are two *sides* to every gluon, atom or molecule. I will be dealing a great deal with these two sides to these particles in this paper, as each individual side looks like a **Tetrahedron** ▲, but both sides together looks like a **Hexagram** ✨. Both are used by your captors extensively, and you will need to learn how that works if you are ever going to do anything about it.

Decoding The Hive

creation of gravity, light, time and the god particle

Stepping up from smaller to larger and larger “particles” or **spheres** from gluon to atom for instance, the INTENT is for the atom to be a standing energy cell large enough to *do* something once specifically commanded to *become* or *hold the shape of* one thing or the other. If the gluon is “1 volt”, then the atom is “2 volts” of the exact same intent to “hold the shape of a spoon”. Then in the same way, the molecule is “3 volts” (or a LOUDER command or POWER SOURCE) to actually bring that spoon up to a physical level big enough to see within the human visible spectrum. Just like every DNA cell in your physical body *knows the codes* on how to reconstruct you again right down to your hair color, each gluon, atom and molecule carries all the codes in geometric pattern form inside to complete any command. Those command codes go all the way down to its smallest sub-atomic level where it all begins, at the **Partiki Cell**. But below the Partiki is the initial COMMAND code, pre-matter, pre-energy, and it is merely an **Intent Command** we will get into soon. For right now we are just covering where the **energy** comes from in order to take a **Sentient Command** into **manifestation**.

Of the two sides inside of each aether particle that creates magnetic push or pull, one of those sub-particles is called a **PARTIKA** which is the **ELECTRIC (+) particle**, and the other sub-particle is a **PARTICUM** which is the **MAGNETIC (-) particle**.

PARTIKI UNITS are the SUB QUANTUM version of GLUONS.

Put 3 particles inside of one sphere (**one** Partika and **two** Particum), and you have a **magnetic (-)** larger particle. Put 3 particles inside of another sphere (**one** Particum and **two** Partika), and you have an **electric (+)** larger particle. Now place one electric larger particle and one magnetic larger particle inside of a sphere called a PARTIKI and you have the equivalent on a **sub-quantum** level that you now call a **gluon** which makes up the energy cluster at the core of an **atom**. Same thing, only smaller. *Way* smaller. Compare the PARTIKI sub-quantum particle to a speck of dust and compare the ATOM to a planet the size of Neptune. You would find **800 billion Partiki Units** in a single photon (**GLUON**).

PARTIKI UNITS AND GLUONS

The smallest **magnetic energy particle** in modern science and the actual smallest **energy particle** are shown here together. They are identically the same, just on different scales:

Decoding The Hive

creation of gravity, light, time and the god particle

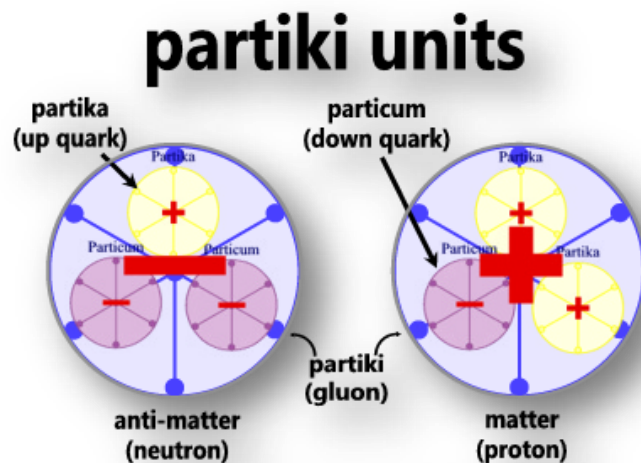

gluon (boson) units

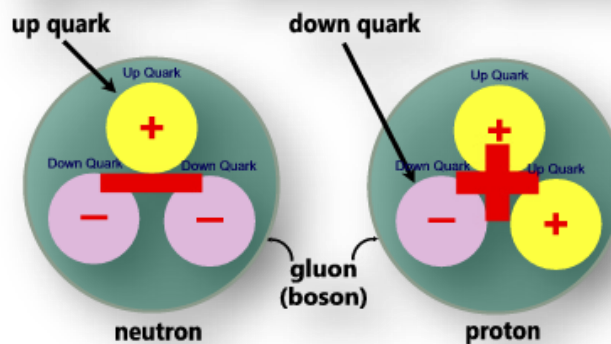

Notice there is no difference between the Partiki and the Gluon shown above. Both are made up of the same elements, electric (+) and magnetic (-). They are just in different **frequency zones** from each other while being called different things. A Partiki in the 1st Dimension would be the same thing as a Gluon in the 3rd Dimension, but the reality they would create would simply be outside of your physical view. There are trillions of dimensions, so there are trillions of ways to say gluon. While going through particle physics, I will be repeating myself for clarity-sake, because it is easy to forget details. I am doing my best to take baby-steps here to establish the platform which energy stands on in order to create life. I will mention now that your reality is in the exact same **pin-dot of space** as all realities everywhere in all of creation. I will mention this again later so you don't let that slip from your mind because understanding up front there is **no such thing as space** is key to understanding how it is light is able to create the spacetime continuum. Light takes up **zero** space, so even using the term pin-dot is misleading but I have to use some frame of reference to even illustrate how frequency zones are the same thing as radio stations. If there were 100 million radio stations, your radio would still be able to tune any one of them in from the same **point** on your counter.

Decoding The Hive

creation of gravity, light, time and the god particle

Each energy cell (such as each pair above creates) has an **anti-matter side (neutron)**, and a **matter side (proton)** and the path that they take **counter rotates** to the exact same pattern of the other. At the **zero-point** space between them, a FISSION/FUSION reaction occurs that creates the electricity that powers all things within creation. Without this movement we call vibration, there would be no energy in which to power the hologram you move within.

This energy-creation begins almost infinitely tiny, building up to a larger collection of particles, and larger collection of particles until you get all the way up to our current atom which when collected together into MOLECULES begins to look like something large enough for our eyes to see. That's when all of a sudden we think it is real, because we can see it for ourselves. And just like simple MORSE CODE of "ON" and "OFF", it builds through a mathematical sequence from the language known as **Keylontic Science**. That language is based on *thought*. The reason why there is an "ON" and "OFF" in energy is because there is always a transition between creating the magnetic energy by the counter-clockwise spin below, then transitioning that energy up to the electric clockwise spin, causing a **pulsation**. That pulsation is at the bottom of the **scalar language** of all **life**, all **manifestation** and **things** known by science called a **dipole moment**. The **dipole moment** is a reaction moment where the energy is refreshed in the fission/fusion which powers the particle just mentioned.

I will explain that more as we go, but just keep in mind right now that **neutrons flash ON** and **protons flash OFF**, always creating a **flashline sequence**, no matter what the particle is doing, what you are seeing, or what is being played out you cannot see.

*There is no such thing as **static**, because at the core of every Atom or Partiki (which are considered static because they are not actually "doing something" at their stages) are clusters inside of each which are whizzing around at a million miles an hour, simply sitting there, holding the charge of that energy at the ready so it can be commanded into action. And **only god** can command them to "do" anything. **That's you.***

Every BUILDING BLOCK (Quark, Atom, Molecule) has a different job to do and how they are stacked on top of each other determines exactly how that job will be completed, just like a mathematical equation dictates how the next part of the equation functions:

- $1+1 = 2$
- $1-1 = 0$

I am showing you TRUE math now, so don't be afraid. Not the math that has been fed to you in order to confuse you and keep you stumbling around in the dark. Remember, science is observation and math is supposed to explain what you see. Not the other way around. If I wanted to confuse you, I would use that math to make you lost until you eventually throw your hands up in the air and say "*screw this*", accepting whatever it is I said to be "true". "*Fine then.*"

Math is a major part of the illusion of this Chimera Reality you have found yourself in now. You are **not supposed to know** how to explain what you see, so you will be the one smelling your fellow classmate's green house gases while no one else does, so you are insane. If I use a bunch

Decoding The Hive

creation of gravity, light, time and the god particle

of incoherent equations to explain something, and you aren't a math geek, you will never understand it. And because it is a language all to itself that would take you years to figure out, then you, the 99.9999%, will simply follow whatever I say.

“That's right class, here is how you properly find the hypotenuse of the convex triangle with an inverted scalene integer:

$$\forall(x, y \in A \cup B; x \neq y) x^2 - y^2 \geq 0”$$

Those who “explain” what you see today are *mathamagicians* using **Hermetic Occult** ciphered language to then back it up with **Pythagorean Occult** ciphered math to prove their point, just as Einstein would back up **Special Relativity** with other totally fictional references such as his own **Relativity** theory to make his point. That is like proving you serve the best chicken in town because your café is painted red. The Secret Space Program mathematicians will tell you right up front they don't use Pi because it is not accurate and it was created specifically to keep mankind from being able to advance beyond the cretaceous level of existence they intend to keep you in.

Pi is *fuzzy math*, but because they have a million equations built on that fuzzy math to *sort of* explain what you are seeing, you believe it, otherwise you would have to one by one disprove a million different equations. The system as you will see later is based on individual egos who are then all inducted into the rarified air of the “fathers” of something within particle physics. Before you will ever get past the first equation, you will automatically face unlimited opposition from that father or that father's 10,000 students who will all be discredited across the board if you manage to dislodge that brick they are all standing on. That isn't going to happen soon, that's why quantum science and mainstream science flip each other off each time they meet in the hallway.

CHAPTER 6

DNA MAGNETIC PUSH AND PULL

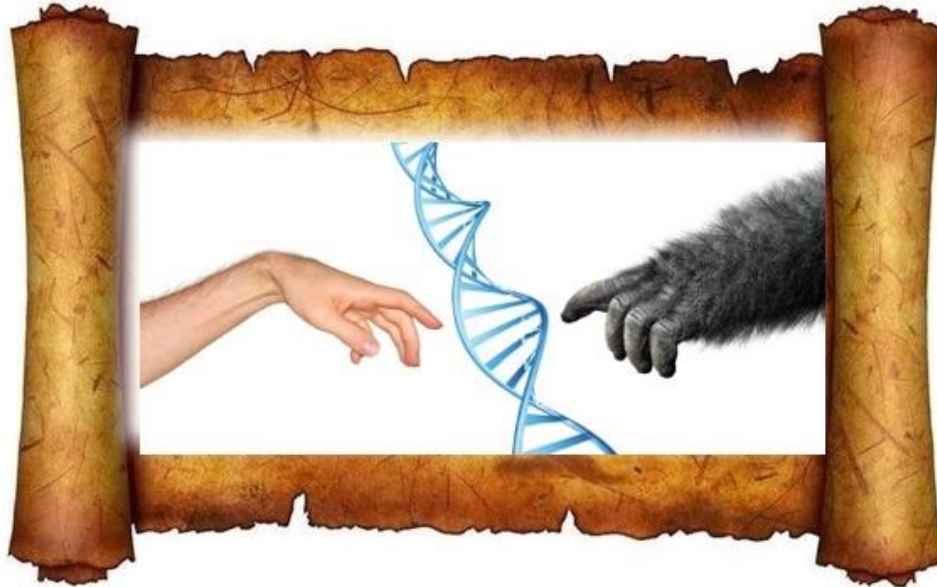

The math behind **Keylontic Scalar Vibrational Mechanics** is like Morse Code. **Samuel Morse** didn't have 4 million numbers to use for his system of communicating across distance, and he couldn't use words like you would on a telephone. He had ON and OFF. That's it. Sound familiar? + and -. 1s and 0s. Yet somehow he was able to communicate with a vocabulary that was nearly infinite. It was merely how a negative was stacked on other negatives or positives that indicated the message.

“... . .?”

Morse code was also used by church bells at one time to communicate before telephones. Ringing a bell three times, holding (silent) three counts, then rung once, held three counts and rung once more would send out the same message to the community that I typed out above. Ringing the bell produced SOUND, which could be heard by the ears. Ringing the bell in your DNA produces sound that you can't hear, but still gets the message across to the next cell in the chain.

... . .?”

Decoding The Hive

creation of gravity, light, time and the god particle



The building blocks of life are in every way a mathematical equation, which is how DNA operates. It is made up of *magnetic* commands to either **push** (**ring** the bell) against the next particle, or **repel** (this would be a **pause** in Morse Code). The double helix structure of how a genetic strand manifests reality is that it always begins with a “**yes**” with **outgoing** energy, then it stacks one command on top of the last one in either **yes** or **no**, arriving at the ultimate outcome that *this is going to be a hair follicle* or *this will be a beating heart*. One difference in the equation will make all the difference in the world;

- $1+1 = 2$
 - This has two components, so 2 is the total product
- $1+0+1 = 2 = 6$
 - Although the answer is the same in modern math, this equation has three components instead of just two, so the product “2” is multiplied by its number of components in the equation, meaning that this 2 *really* means 6 when used in the binary code of on and off
 - $1+0+1 = 2$ (product) $\times 3$ (components) = 6

So when your double helix strand is commanded on the 1 millionth level to “do 2” or “do 6”, it simply takes that number, multiplies it by which rung of the ladder it is situated on, and then it gets a precise command to either attract or repel the next genetic cell in the chain (“ring the bell”), 1 time or 5 times, or a million times which causes the next cell to vibrate in the exact frequency of its commanded function. And since frequency (sound) commands the aether to *do this* or *do that*, the aether knows by the 5 million combined frequencies your DNA strand is emitting, to *give you brown hair, blue eyes, white skin and buck teeth*. Just like equations in

Decoding The Hive

creation of gravity, light, time and the god particle

mathemagics, *if this, then that*. The difference is there are no fractions. There is never $1/3^{\text{rd}}$ of *on*, and there is never $1/6^{\text{th}}$ of *off*.

PARTIKI ENERGY UNITS

Expanding on what was mentioned in the last section, at the foundation of material existence, energy particles are known as **Partiki Units**. Every pin-dot of *space* within existence is another Partiki Unit (which is **aether**). Particles of awareness. In the bigger picture of the fabric of space which makes up what you see, each one can be called a Partiki **aether pixel**. You will understand this as we go.

Aether, or Awareness “particles” attributed to “god” or some other intelligence isn’t just some myth or superstition just because *you can’t see it, so it must not exist*. Aether is both the power and the awareness that is quantum-entangled to all things and all life throughout all that there “is”. We have no explanation as to where “it” came from, or how, it has just always *been*. In religious texts you have heard of many beings who have claimed to be this god, but in every instance, they were either speaking collectively on behalf of all aether particles, or they were suffering from childish delusions of grandeur. This has been the case more times than anyone could ever count. Particles of awareness who allow ego to take over and then seek to set themselves up as “the” particle with *more power* or *higher knowledge* than any other particle. This is glittering unicorn scat and you might as well understand that right now. No particle has more potential power than any other one. They are all the same; infinite.

Every pin-dot within all that is, is another AETHER particle. INDIVIDUAL awarenesses within the god family.

And every pin-dot is also aware of all other pin-dots and everything that *has happened* since awareness came into being. ALL of these pin-dots are aware of *all things*, but a handful of them have evolved past just this stage and have become **self-aware**. Meaning they can make a choice to do something on their own, without consulting another pin-dot for permission to *do this* or *do that*. Those pin-dots are known as **Sentient Spirit Essences**. The only difference between a *normal* pin-dot and a *sentient* pin-dot is the Sentient dot has become opinionated to the point where simply existing is no longer enough. They, just like the non-self-aware pin-dots also know all things through being quantum-entangled (through the **Eternal Unified First Fields** of god-source) to all other aether particles, but **Self Aware** pin-dots can choose to do anything that they want. So how does a pin-dot, without any hands or feet or mouth to speak with *do* anything?

For now, I will simplify the subject to say that **Partiki Units** are **aether particles**. ALL aether particles are all-knowing and some aether particles are **self aware**, meaning they are *creator* gods. Partiki Units while inside of material manifestation do have a scientific name, but rather than distract you with that just now, I use this term to establish that aether has an electromagnetic signature while in **manifest form** that powers its body, which should *put a face on the name* for you.

Decoding The Hive

creation of gravity, light, time and the god particle

Partiki energy generators (aether) hold *static electricity* by which all things are moved into the holographic visual and tangible field. When the command is given by a Sentient being for those energy particles to do something, the command comes from a physical **spark** created within the mind of a Sentient being, something you have heard about all your life. The **spark** is REAL and modern science even admits this. When captured on Electroencephalography (EEG), brainwaves create energy out of thin air. NOT thin air, but the fission/fusion reaction created from thought itself. Robots' thoughts can't do this. Yours can.

ELECTROENCEPHALOGRAPHY

EEG brainwave sparks light up different sections of the brain when different thoughts are imagined. Each one of those differing sections we see in the electronic image results depicts a different part of the brain. Within those different areas are scalar-vector locations that are mapped and indicate a different type of thought. The simple sparks we see are actually nuanced with different shades. Each shade of color emitted by each different quadrant vector produces a different command which is heard by the aether. These commands can be duplicated by 2D drawings, then those drawings can be given names. Then those names can be intoned by a person and the color of the sound emitted by the mouth can mimic the precise color which is the precise thought or intent of the person. This is the foundation of the **Command Signet** process we will be getting deeply into later. Imagination is what sets apart Sentient life forms from artificial life forms. Only Sentient beings can cause that spark that happens when creating a unique new thought, this is why only Sentient beings are able to command the aether using original, new thoughts in order to **manifest** anything. Artificial intelligence can only mimic what has already been thought by a Sentient being, and only by using those 2D drawings that have been "hexed" to code that image or Signet to that exact unique thought:

Decoding The Hive

creation of gravity, light, time and the god particle

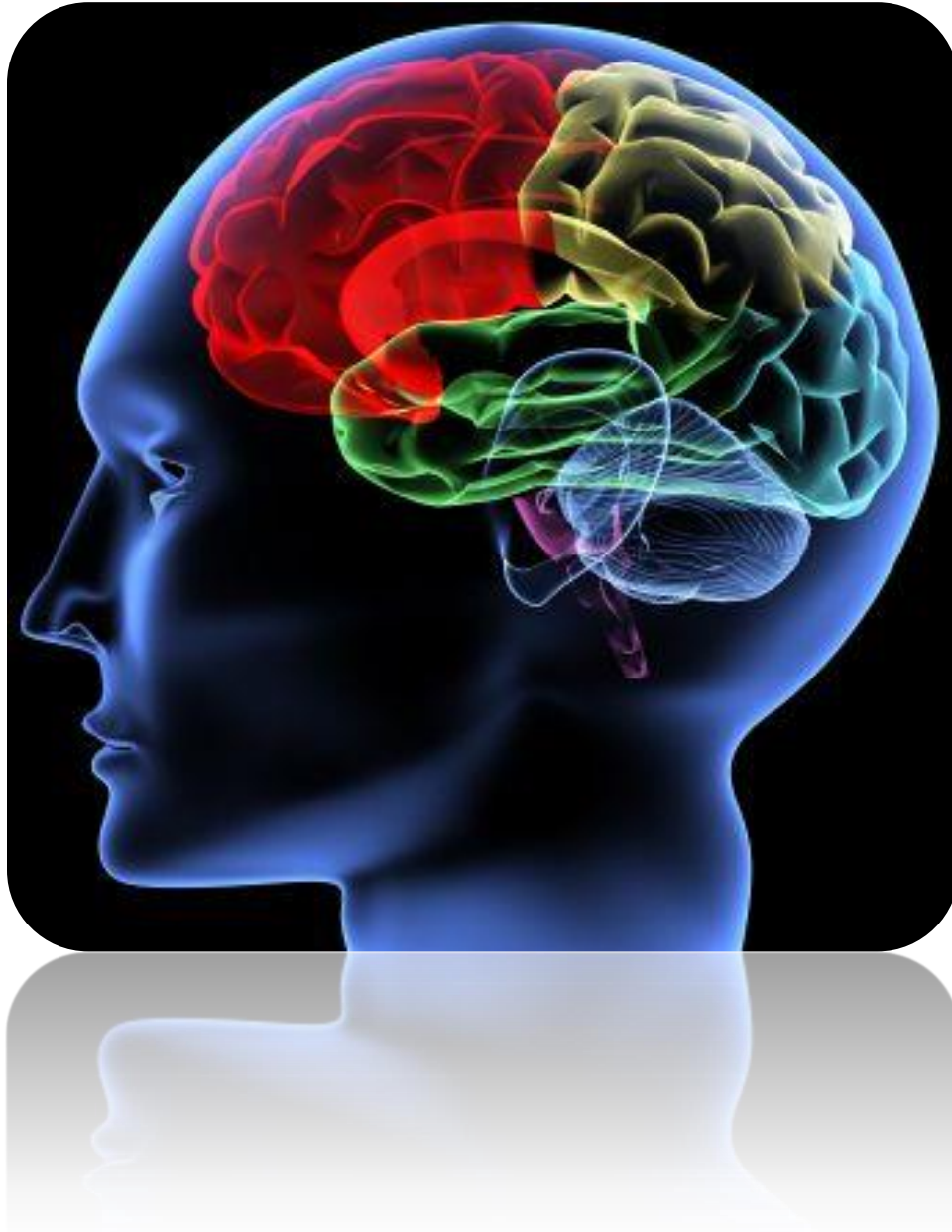

SCALAR VIBRATIONAL MECHANICS

At the base of “creation” are geometric symbols. I am not showing you “all the symbols” now, because I don’t have a million years to get my point across. I am just showing you how things actually work in taking nothing but positive (+) and magnetic (-) energy and creating something you can touch with your hands, eat for lunch or drive into town.

Geometric symbols simply represent an **aether command** that your eyes can see. They are **generated** by sound. Your thoughts create a **spark**. That spark creates a **sound**. The sound

Decoding The Hive

creation of gravity, light, time and the god particle

creates **light**. The color of that thought is a color that only your precise thought could have ever generated. It not only contains the image of “the house” you wish to manifest, but it also carries trillions of nuances of your personality or perspective that have come from trillions of moments you have experienced that made “you” who you are at that precise moment in time. This means that even if someone were to imagine the same “house” in their mind as you did in yours, there would always be a difference between those two houses, no matter what. In your house might be a white toothbrush holder on the wall, but someone else’s holder would be pink or blue. That means in the color that was generated by the spark in your mind is the only frequency of that shade or color that will ever exist in all time unless someone **coins** it.

Our term for money just so happens to be the exact same one for assigning a name to a process or thing. Not by accident either, because the two represent the same exact thing, duplication. This is also known as plagiarism. And it has been through plagiarism that the Nanites have been able to manifest reality, using Command Signets that tell the aether exactly what it is they wish to see. By programming a god (like you) to think a certain thought by using **Signets** that had been **coined** by some other god, they use your power to create these ultra-nuanced colors or shades that can only be generated by a member of the god family. Then it is **your thought** that recreates the intent behind that “coin”. While your thought may not see the pink toothbrush on the wall of that house they are tricking you into manifesting, the original creator of that house had already encoded that holder when they first imagined the house. Then he created a **Command Signet** that would visually equate to **that exact house** by using the power of creating a **Fire Letter** (complex command). Now any god who invokes that exact symbol will tell the aether to create that exact house, right down to that toothbrush bracket. The fact that coin is the word we use for a fraction within the Magic Money Program is absolutely no coincidence. Don’t worry, we are going to cover Fire Letters and Command Signets until this entire process is clear in your mind.

Your thoughts not only create colors, they also create symbols all by themselves that are made out of the pattern that the waves make within the Event Horizon of the atom they eventually

create, which I have already shown you a sample of that looks like a Spirograph image . Every unique thought made by a Sentient being creates as unique a geometric image as the color that was generated by that thought. These geometric shapes can also be *coined* and then used as **Command Signets** just as any made-up symbol which can be used to indicate your one precise, unique intent. The Nanites have used every conceivable shape and symbol for their millions of Command Signets by this time, so using the actual symbols printed out by the aether itself would be a relief for them to simply grab, slap a name on it, and use it. You can bet they have billions of such “templates” cataloged at the ready any time they need to institute a new series of Fire Letter Commands for a new program.

I realize just how foreign this all sounds to you at this point, so let’s take a look at how the words you speak create real, actual patterns out of any medium you speak them into, from water to sand to baby powder. Anything that will fluidly adjust their particles to reveal the geometric pattern of the sound vibrations from your tone. Of course these are wave patterns that don’t just show up around us in normal circumstance you are able to see unless you use technology that turns your thoughts/sounds into something visible when they are too small yet to see within the human

Decoding The Hive

creation of gravity, light, time and the god particle

visible spectrum. Just like a radio can turn invisible radio waves into sounds loud enough for you to hear, a **Cymascope** and a **Tonoscope** can turn invisible sound waves into images you can see.

The images below are geometric images that speak the interdimensional language of Scalar Vibrational Science and can be thought of as letters rather than symbols. These are the building blocks within “real life” as well as within holographic reproduction such as used in **television** and **radio** broadcasts *and are at the base of all particle physics*:

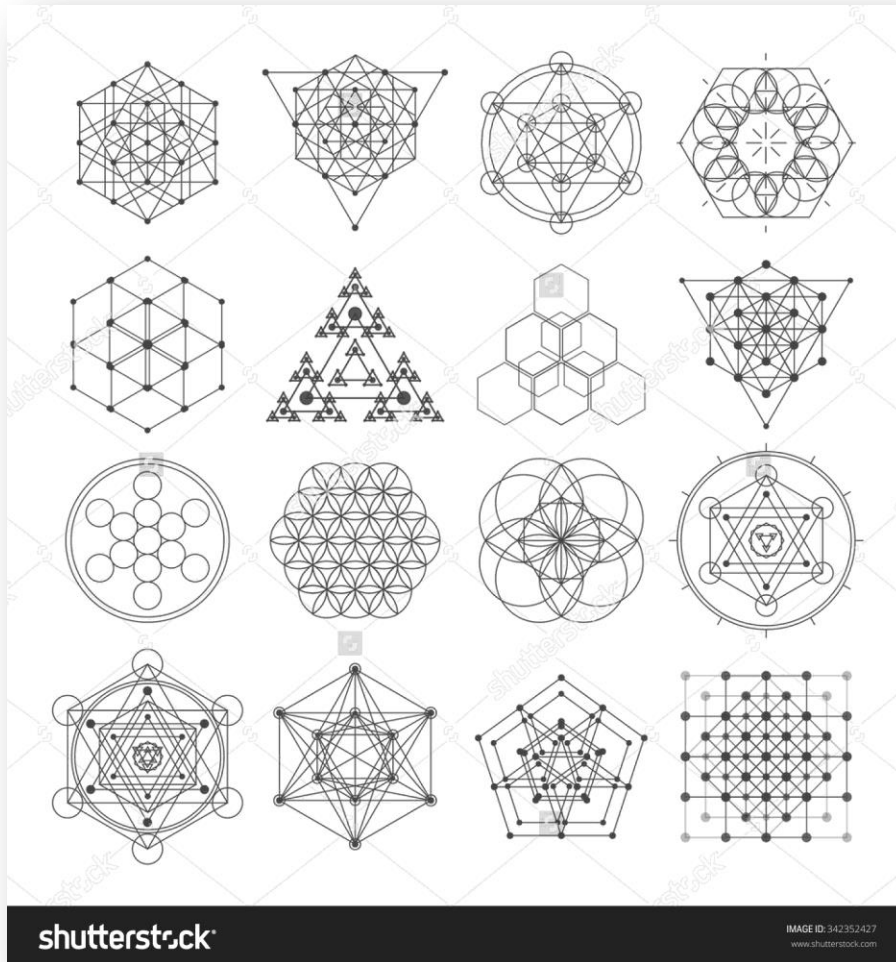

What you see above are the 2D drawings on a flat surface to illustrate what a precise frequency tone looks like to the aether. Each image “in real life” are 3D, as in spherical form as seen here:

Decoding The Hive

creation of gravity, light, time and the god particle

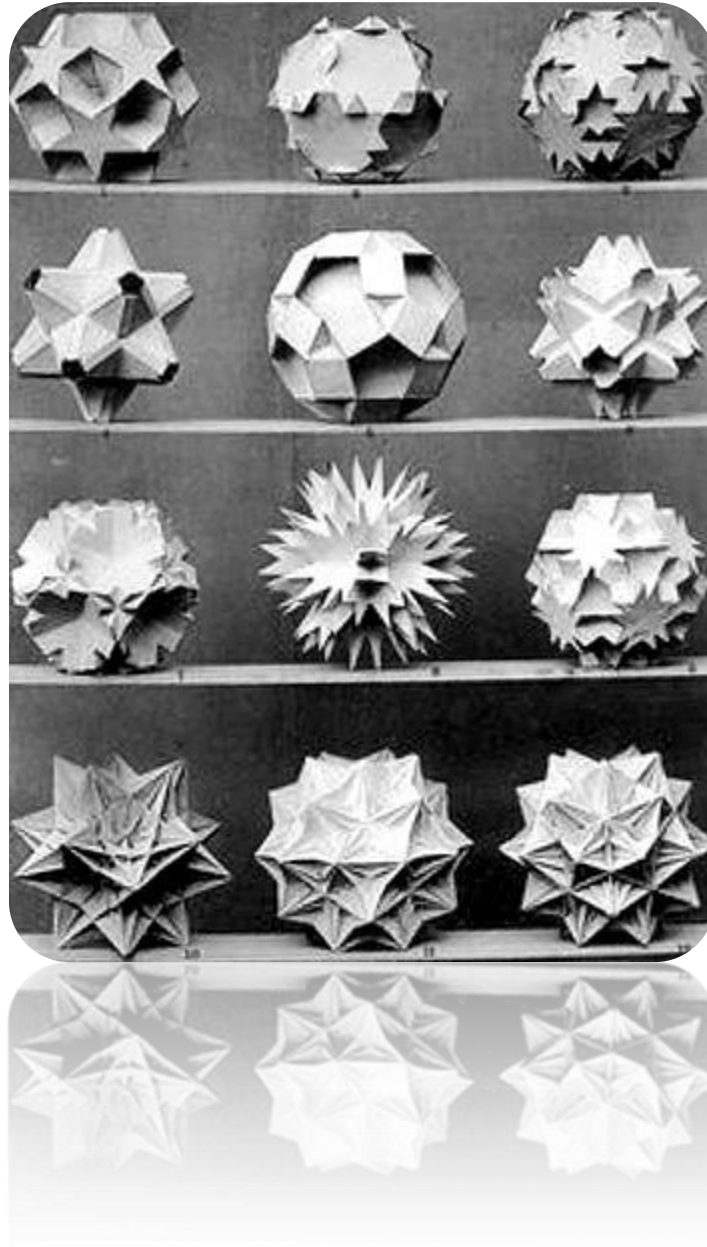

Everything on the “material periodic scale” has a shape at the base of these spherical geometric configurations, whether it be wood, air, iron or water. Below what is seen by the naked eye, all particles are structured, therefore all things have a geometry of how to assemble them using straight lines on a piece of paper. If you had a box of toothpicks and some glue, you could make the quantum image of anything from cotton to plutonium on your kitchen table. You can also make the same images and everything they build up to, with your thoughts, and I do mean in real life, not just in your mind’s eye.

When an adult male intones the word OHM (“oohhmm”) through a *mechanical* Tonoscope, (which is the sound of the letter O which is the universal, world-wide symbol for the value of Electricity *-ohms-* shown as Ω) it looks like this when turned into a visible image. This is the

Decoding The Hive

creation of gravity, light, time and the god particle

shape of a **KEYLON PARTIKI GRID**, at its lowest quantum, or the **FIRST COMMAND** aether particle to begin the process of casting visible reality:

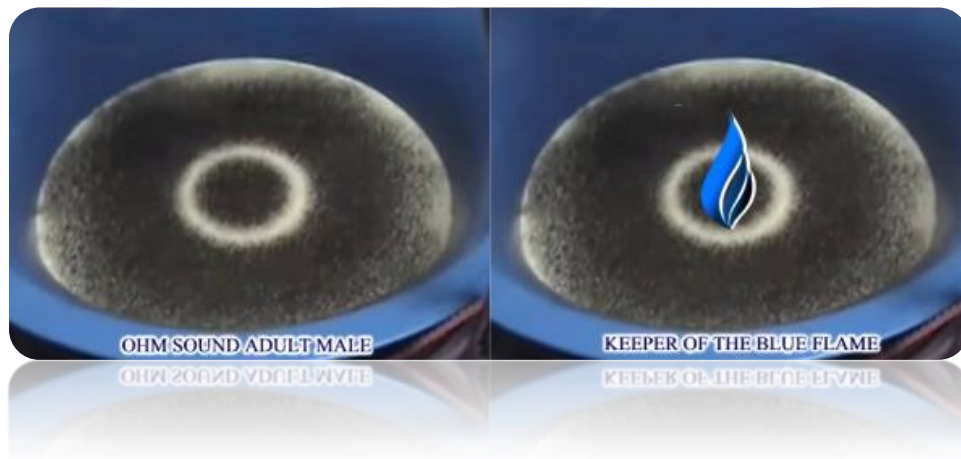

The **O** at the center shown here by a single frequency is the **BASE** tone for all manifestation. It is the **ZERO-POINT** repulsion zone where nothing inside its diameter carries a gravitational signature and where “time” does not exist. This is the **SEED** of manifest (material reality) **INTENT** of the Sentient being who wishes to cast something into reality as commanded to the aether particles. Consider the **O** as the “*keeper of the blue flame*” (spark) of your **INTENT** or thought. You are learning a completely new type of language, so I will be redundant when trying to get across what it is you are seeing.

When an adult male **intones** the vowel **A** (“**aaaaahhh**”), it looks like this. The expression of the **TEMPLATE** that generates manifest or physical expression. At the **CORE** of the **Hexagram tree of life** is the **SIGNET KEY (KEYLON) PARTIKI** particle (**O**). The Hexagram is the **ACTION** (intent) of the **PARTIKI UNIT**, and the **O** in the center is the **SIGNET KEYLON** that gave the first **COMMAND** for those particles to travel in that precise 6-point pattern:

Decoding The Hive

creation of gravity, light, time and the god particle

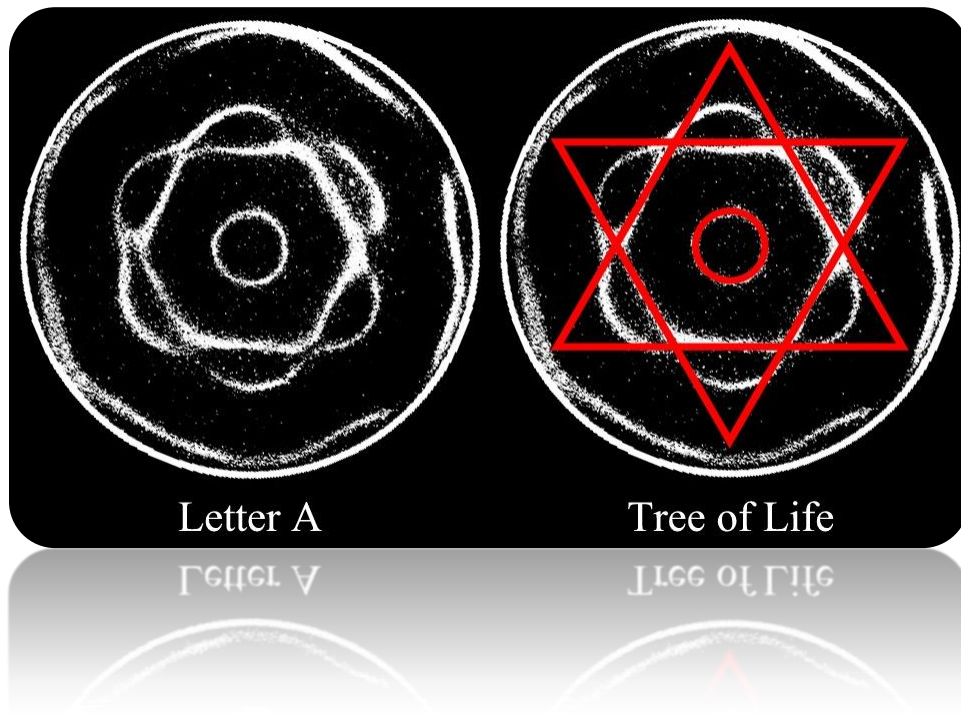

When an adult male intones **OHM** (which creates the seed of life circle at the core of every particle) and then *adds the vowel A first*, creating the **AOM** sound, it creates the seed of life, the tree of life, and then multiplies that tree into infinity, *just like turning up the volume on your radio*. This image shows the sacred Mandala (multiplied tree of life Hexagram) as gathered from around the world in ancient applications. The top right image was made with a **digital Cymascope**, *just from an adult male saying “aom” into the microphone*:

Decoding The Hive

creation of gravity, light, time and the god particle



1000 YR OLD SRINGERI MANDALA



AOM SOUND ADULT MALE

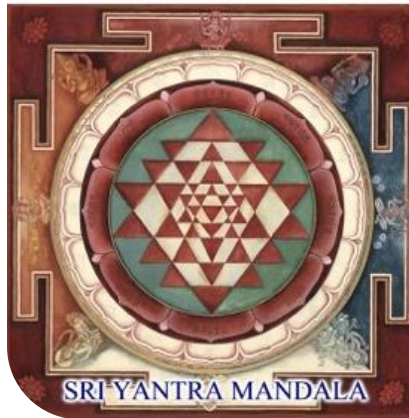

SRI YANTRA MANDALA



ANCIENT WATER FOUNTAIN

The **intent** behind the Mandala is **life**. Perfect, harmonically balanced, life that resonates to your organic DNA structure that is still in the shape of the tree of life Hexagram, underneath the Anunnaki Particle (explanation on this to come) that distorts its mission. Using this symbol in the middle of a water fountain will help correct the water flowing past it back to its original vibrational signature to support and preserve all biological things. That the ancients knew to use this precise geometric symbol in the middle of a fountain isn't surprising and the image was no "accident" or coincidental pretty picture. The ancients knew it, and **Edward Leedskalnin**, the genius behind the famous **Coral Castle** monolith in Leisure City Florida knew it. His castle was made of limestone (nearly *pure* crystal) made of blocks as much as *30 tons* each which he constructed entirely alone and at night while nobody could see him using anti-gravity to position the stones. This feat was magnified by the fact that Edward stood *5 feet tall* and weighed only *100 pounds*, so he was not using brute-force in his work.

Decoding The Hive

creation of gravity, light, time and the god particle

In his estate is a fountain made out of a giant, 1-piece solid stone with a perfect 6 point hexagram at the center. Perhaps he didn't quite know about how to multiply the effect of the hexagram, but he certainly knew what it could be used for:



The more complex the aether command, the smaller “zero-point” (O) at the center, not because it is less important, but because it is simply “making room” for the command. By the time you have added more details within your command where they become “nested” as the multiple “trees of life” shown in the Mandala, the zero-point reduces in size visibly, to make room for the specifics of your command within the EVENT HORIZON (diameter) of that one thought. While you can't see the O in the center of the geometric pattern above, it is there and it will forever remain there as the “tiny speaker” sending out the message to the aether particles. The command above tells the aether to revitalize life-essence within the PLASMA FIELD surrounding the space where you visibly see the pattern. All things have plasma fields that continually speak to the aether which I will explain in detail as we go. The SIGNET at the center of the fountain's plasma field would be large enough to treat the water within the basin to re-structure it to its original genetic composition so it will more powerfully support the life of anything drinking. You are about to learn that water is the **LIQUID SILICATE** *amneo fluid* foundation of everything you consider life within your *holographic* reality field, and **every drop** is infused with microscopic crystals that act like capacitors to power the mission of the intent.

CHAPTER 7

VISIBLE REALITY FIELD

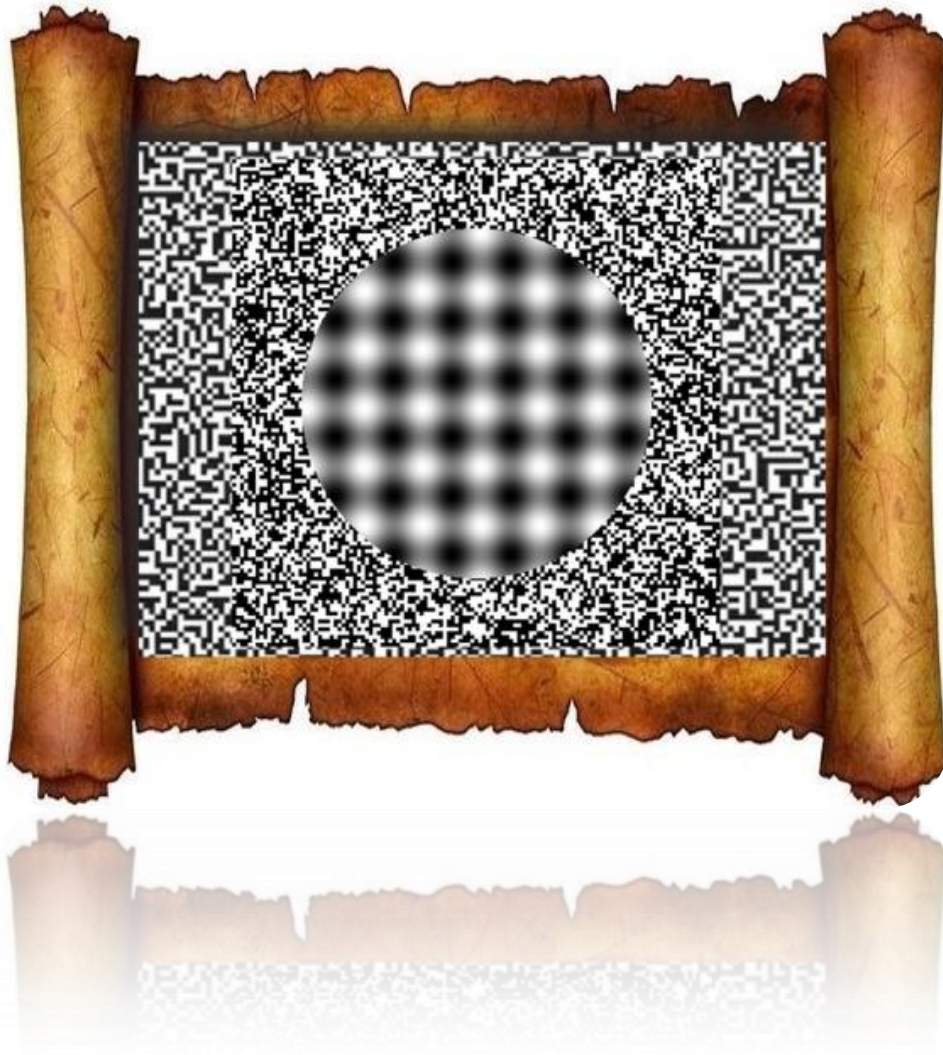

By now it is no mystery that your eyes don't see all things you would consider "everything there is". And even the image above shows at a casual glance that even what you do see isn't for certain just as it appears. While this image looks like a GIF moving image, it isn't. It is a perfectly inert jpg image. The distortion is caused by your eyes interacting with the combination of pixel patterns that are not found in organic nature. If a simple grid pattern at a larger scale as seen through a hole in a pixelated foreground works to confuse your sight, imagine what could be accomplished by moving images projected from photon guns firing away at millions of miles per second.

Decoding The Hive

creation of gravity, light, time and the god particle

Your field of vision is highly locked into your perspective of “time” and of “space” at all times. It was supposed to have been completely different from what you are seeing with your eyes right now, but of course that has been artificially distorted by forces that have been largely outside of our control over a very vast period of perceptible time. Your visible spectrum comes in through your eyes of course, no matter if you are looking through a microscope, telescope or simply winging it with the naked eye. What you see are made up of particles that have differing rates of speed which make them appear larger or smaller, depending on how they dilate into your pupil. They LOOK real, they FEEL real, but in the end, they are all holograms no matter what they seem to be to your senses. Their particle spin-rate speeds coincide with the frequency range they are supposed to harmonize with. In the 3D world, the spin-rates are very slow. In higher dimensions, the spins increase progressively and incrementally for each different dimension. They also differ within each different Time Matrix so there is no bleedover into other Matrices. Spin-rate is frequency. Slower is lower and faster is higher. You can't see even 1/1000,000th percent of all the visible spectrums from this dimension. In fact you can't see even that much of just this one dimension, as it is interdimensionalized into at least 100 if not 1000 or more incremental realities.

The **planets**, just like **quarks**, are making up the **nucleus** of an **energy cell (atom)** as they move. You think quarks are small and planets are huge. When in reality, everything is the very same size, the size of a Keylon Grid or as already mentioned, much smaller than the period at the end of this sentence. They just exist in different frequency bands within the very same space, just like “FM 95.6” waves on the radio dial travel through exactly the same air as “FM 102.5”. Geometric patterns are created by the path of the particles as commanded to travel. The 6 point Hexagram happens to be the tree that all *organic* “fruit” grows on within the 3rd dimension of this Time Matrix. This is the shape or **symbol** of the language **signet** of **Keylontic Vibrational Scalar Science**. All things have a signet of some kind. The 15 Level Time Matrix of Gaia's symbol is the “star of David”. It has been hijacked and I will be showing you how that happened later in this paper. The **symbol** that has taken this over will be extremely familiar to you once you see it. It started out looking like this:

Decoding The Hive

creation of gravity, light, time and the god particle

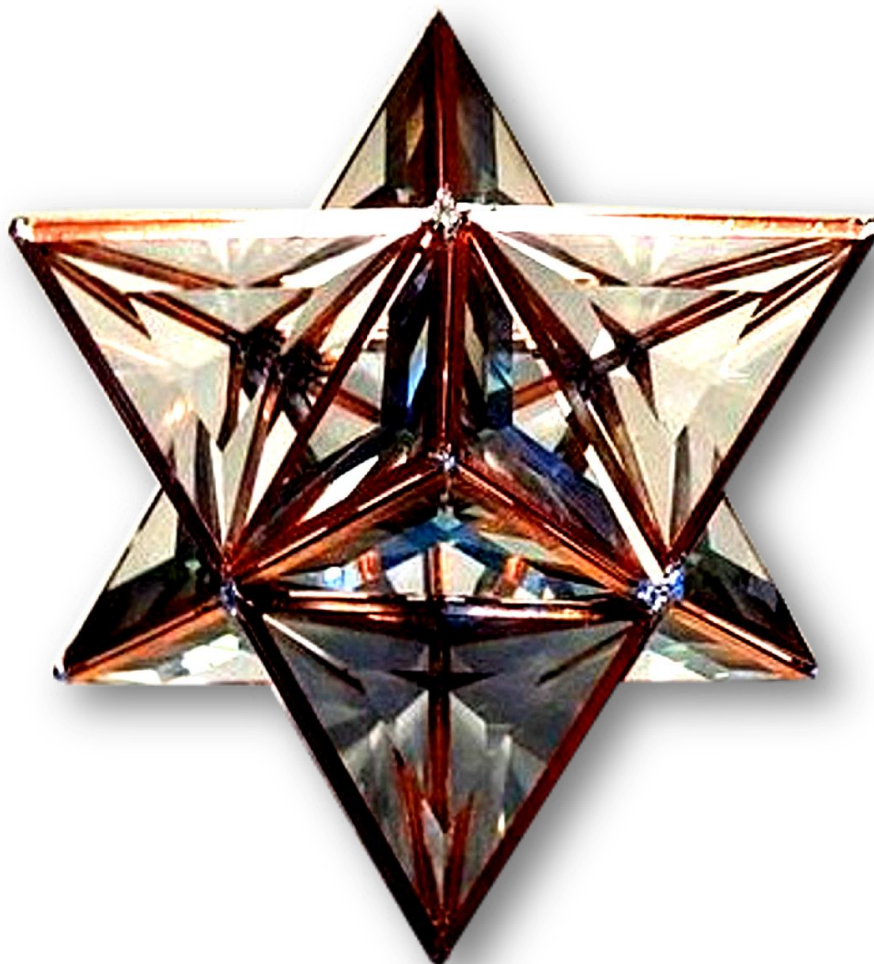

The particles (waves) inside of a **Partiki Unit** travel the geometric path needed to power the next bigger (more complex) UNIT of energy measurement, just like quarks travel in their own geometric path in order to complete a **gluon** sphere, then an **ATOM**, then a **MOLECULE**. The only difference between planets and quarks is you think you see them at different sizes from each other through a telescope or under an electronic microscope. All that is different is the power level they have built up to carrying, and only frequency bands separate them from the standpoint of your view. Microscopes don't show you *smaller things*, they show you elements within other **lower energy** dimensional frequency spectrums or frequencies that are lower on the musical scale Gaia operates on. All things, **all things** come from *thought*, then thought creates **sound**, sound creates **color**, so all things that exist in some form of reality *are SOUND and each SOUND has a COLOR*:

Decoding The Hive

creation of gravity, light, time and the god particle

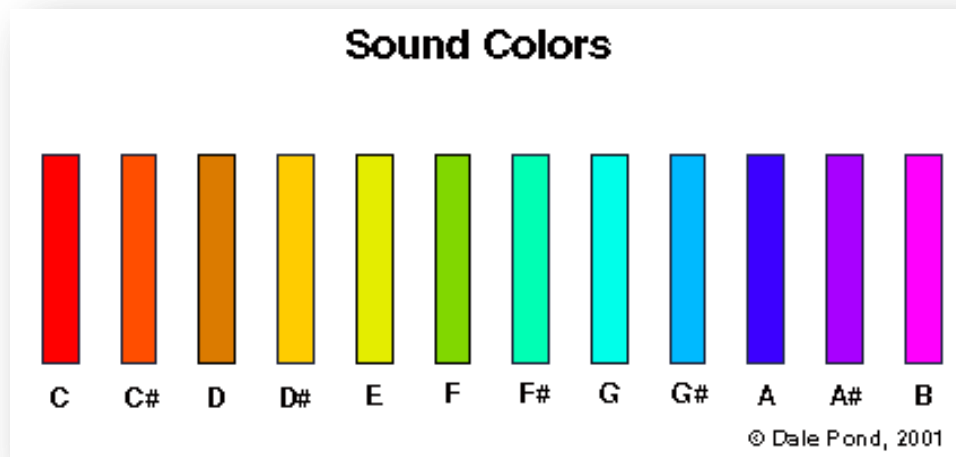

Inside of each color bar above are many gradient shades that move ever further to the right and up the scale. While you are in the 3rd Dimension, you don't just live inside of that one frequency band, you will be moving up through that Dimension, one fraction of **color** to the next until you ultimately step completely into another color-band (octave) where you will either progressively get smarter (through education, increasing your frequency) or you will not continue to ascend up *the scale*. Between each primary color are trillions and trillions of other colors, and every set of primary colors exist within their own frequency spectrum and progressively repeat as the frequency elevates into octaves that play the same colors all over again, only in different keys. There are no ends (lower or higher) to the true scale of color or sound in the Primal Fields of Liquid Light and Sound:

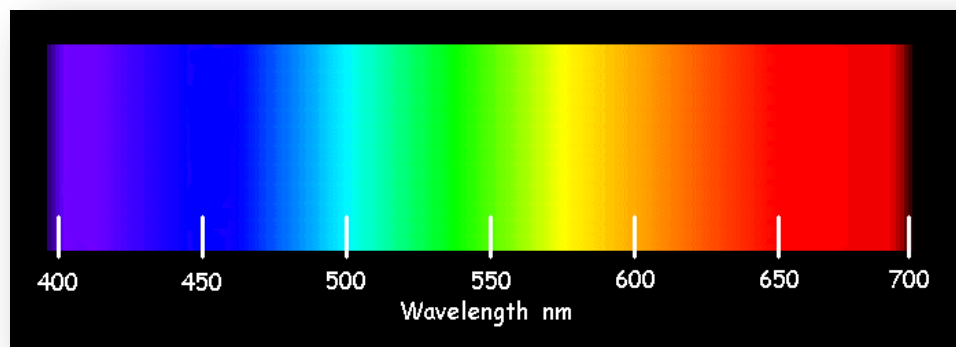

VANISHING POINT

The human eye sees in a *vanishing-point* perspective where you think things *get smaller further away from you*, but in reality they are all in the very same spot. Only by giving your senses the *illusion* of space does space exist, and only by giving you the *illusion* of size does size exist.

Decoding The Hive

creation of gravity, light, time and the god particle

Keep in mind that all of reality, all solar systems, all universes and everything inside of them, all sit on the needle-point of a pin as I mentioned before, the only separation between them are layers of frequency that do not take up space, like a book with stories of 1000 different worlds written inside, made of paper with no thickness to each page. In higher dimensions, your planet looks like a grain of sand and lower dimensions than this one, when placed under a “microscope”, seem much smaller than that.

The drawing below is an X with a rectangle in the center. A total of 8 lines. Right now there is no depth to this group at all. But because there is a point in the center, you are able to look at that point where the lines cross, and now it looks like a tunnel going off into infinity:

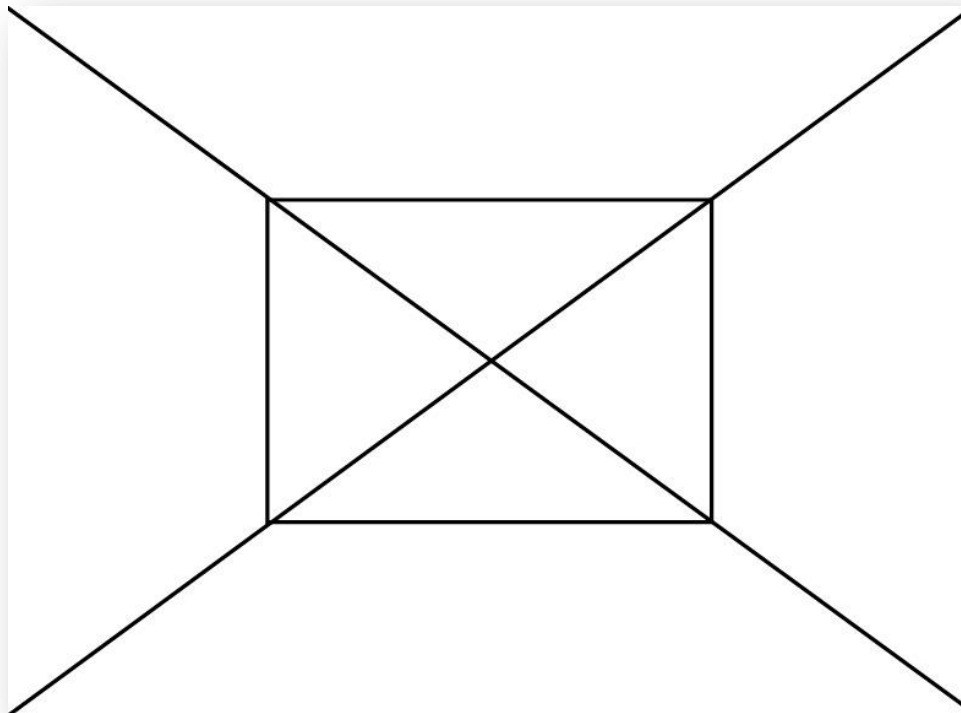

The same “piece of paper” shown below with those same lines along with a few others that all either meet at the dead-center of that X, or they are in parallel with the lines of the square show how the eye can perceive it as a completely different thing, even though the original “square tunnel” remains. The lines inside the rectangle are less bright, making them effectively vanish to your initial glance, and the other lines turn that tunnel into a home:

Decoding The Hive

creation of gravity, light, time and the god particle

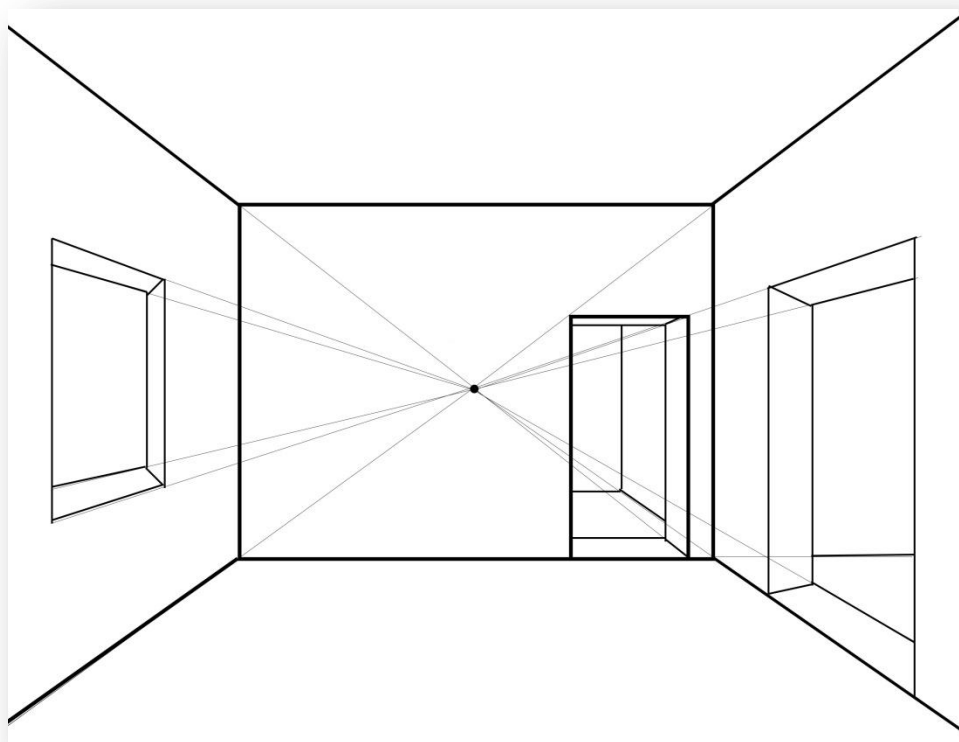

If your eyes didn't see the wall at the end of the drawing within a vanishing point perspective, there would be no depth at all, and this would just look like a bunch of lines on paper that made no sense other than perhaps appearing as a tunnel as shown previous. In reality, this drawing is on a flat piece of paper taking up no space of any kind, but now it appears like there are multiple rooms and the same "piece of paper" just became *multidimensional*. The scalar waves that hold the image of each line on the paper take up **no space at all** on either the paper or the screen. And on this same screen in front of your eyes, I could stack a hundred million of these rooms on top of each other and they would still take up no space, but they would all hold the scalar waves of multiple rooms within each one. In reality the lines on the paper are light waves which can stack on top of each other into infinity, just like the graphic. You could look into each room from the very same seat I am sitting in now if I merely move aside the top 1, 50 or 50,000,000 layers first. Dimensions do not take up space, drawings made out of photons don't take up space, and reality doesn't take up space; meaning space, just like time, is fully artificially created using electricity which doesn't take up space either. Everything shown to you above is held inside the pin-dot at the center of your screen where all the lines intersect and that pin-dot could easily be considered the zero-point of trillions of planets and trillions of trillions of beings, along with all of creation itself.

When you place *space illusion* and *time illusion* together, they are called **spacetime**. If the room at the back of the drawing had another doorway opening to another room, and another room, you could draw a million additional rooms in every single picture, and then layer a million pictures together. Each of those pictures would then be a **spacetime continuum** where each would

Decoding The Hive

creation of gravity, light, time and the god particle

appear to go into infinity, just as *outer space* has been created. In reality the stars are not *out there*, and the mountain off in the distance is exactly in the same place where you are standing, just like the picture above is right there before your nose. While Bob can explain all this to you in basically the same way as I did just now while he is smoking a joint, that's where the big picture always ends. I will be showing you the science of how this actually works in the real world around you in just a moment so hang in there.

BIG THINGS AND LITTLE THINGS

Between each color in the gradient color spectrum image a page or two back are trillions of trillions of shades transitioning between each shade as mentioned. Each color is a SOUND frequency. From the "key of C" to the "key of B" shown above can literally be thought of as dimensions and if you want to think of the soil of your planet which just so happens to be brown, and your position in the 15 Level Time Matrix as the 3rd dimension, it would mean that you now live inside the "key of D" and are transitioning into the "key of D#" of the 4th dimension:

Decoding The Hive

creation of gravity, light, time and the god particle

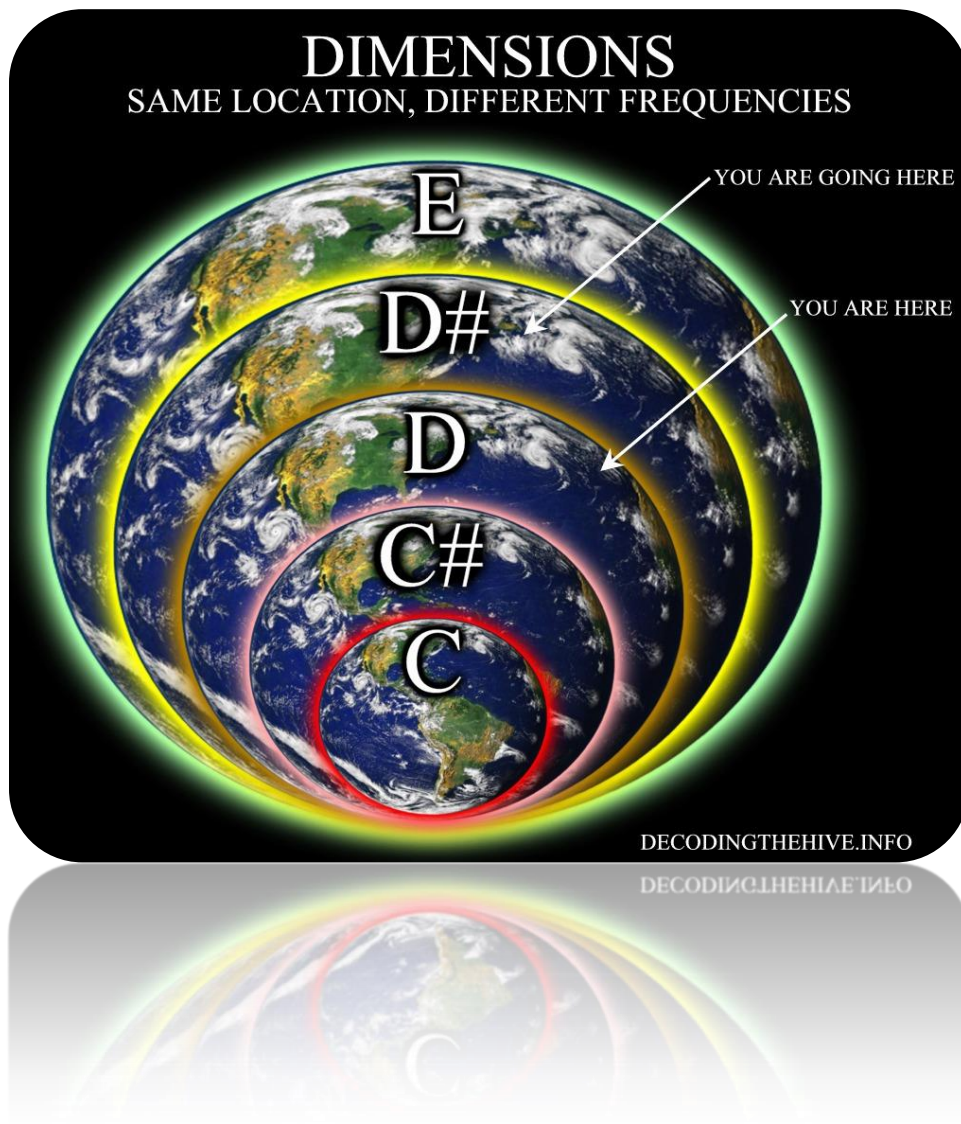

GEOMETRY OF FIRE LETTERS

Partiki Units travel in very simple geometric Signet patterns. Gluons travel in more complex Signet patterns. Molecules travel in even MORE complex patterns. In the same way, planets travel, as you can see below, in VERY complex **FIRE LETTER** patterns. The more complex the pattern, the more **energy** the **energy cell** can develop, just like winding up a rubber-band-powered toy. The more twists, the faster it goes. The more **paths** in the geometric procession of the positive and magnetic aether particles, the larger it appears.

Planetary processions show their energetic, organic geometric **Signet Template** that *prints out* a pattern *in the sky* as it were. In reality, that planet is just another **atom**, but because tiny people live there and it all seems real to them, then their planet appears gigantic compared to their size,

Decoding The Hive

creation of gravity, light, time and the god particle

just as earth seems to your perspective. Try to keep in mind the actual size of an atom while looking at these procession patterns so you can grasp the idea that atoms, planets and solar systems are all invisible in size unless you use a scanning microscope to see them unless your frequency is tuned the same way as the microscope is, allowing you to see it as a *planet* with your own eyes. Outer space is the same thing as the distance between atoms which is **non-existent**:

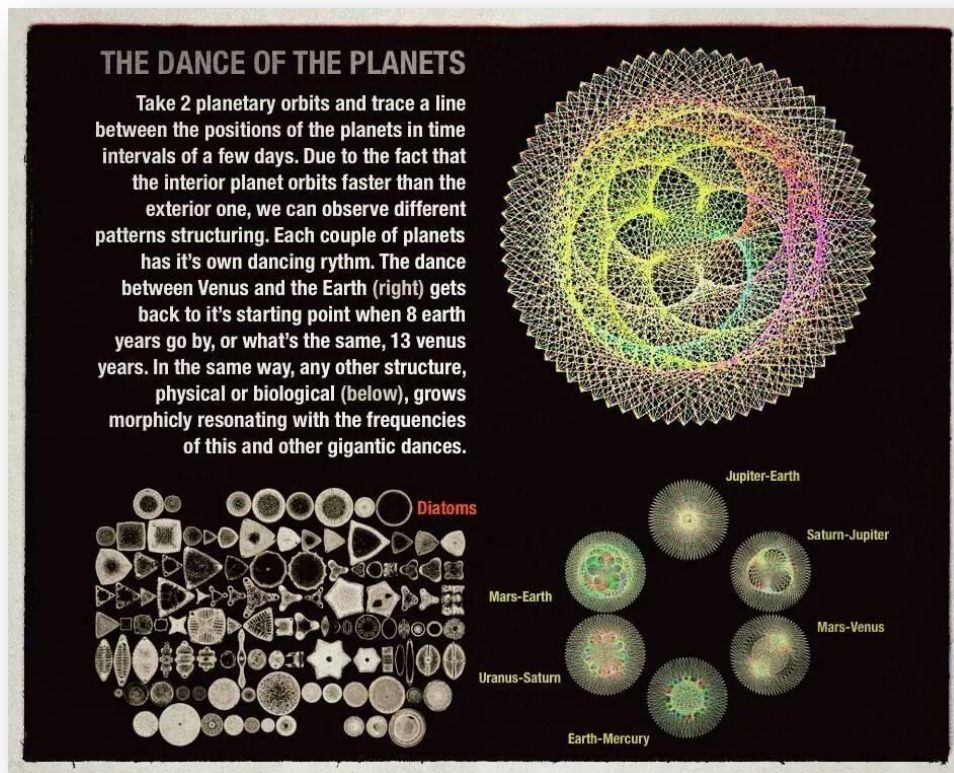

The aether particles know exactly which symbols dictate which command, and the **non-self-aware** particles from the **Standing Energy Fields** of god-source hear those commands and then promptly make the *wishes* of the **self-aware** particles come into MANIFEST reality. Something you can *see* and *hear*, etc. Atoms follow the commands, baseballs follow louder commands, planets follow much louder commands, and universes (Time Matrices) follow much louder commands even yet. But each one are the same size, and each one completes its own spherical event horizon that looks either perfectly round or oblate when seen from a bird's eye view at this time. This is a big topic that will be addressed deeper as we go. You would call this an orbit in both particle physics, as well as celestial-speak, because they are the same things on different musical scales.

As you are about to see in upcoming chapters dealing with elemental particles, some particles such as bosons, can all “take up the same space” as each other. In fact “100” bosons can be sharing that same space, yet science can determine there are “100” of them there, due to their energy signatures which are **unique**. In other words, each boson has a different “song” it is

Decoding The Hive

creation of gravity, light, time and the god particle

singing, which can be measured. And those bosons can be identified individually as they *self-line up* under the rays of a laser beam. Their perfect line they make can then be triangulated using time and pulsation which shows them to be precisely laid out in perfect pixel increments that carry a Y and a Z location point that are precisely equidistant apart. When the laser beam is turned off, the bosons just mill around, perhaps all standing in the exact same place once again. In other words, they only **do something** when they are being **told** to do something. The laser is the one telling them exactly what to do and how to do it, because it carries the song of that laser-beam's mission. Just something to stick in the back of your head for right now.

The **GEOMETRIC SIGNET TEMPLATES** that express a command to the aether are called **SIGNET KEY CODES**. These patterns speak the command language of the standing **electro-tonal wave fields** simply known as the **Standing Energy Fields of god-source**. At its **most basic** form, a **SIGNET KEY** will look something like the following image below. Just like the geometric pattern of our planet's claimed procession, **Signet Keys** become incredibly complex depending on all the commands that are nested inside. At a certain point of higher and higher energetic signature, these **Signet Keys** become **FIRE LETTERS** which are in effect, millions, billions, or trillions of commands, all inside of **one template** which is really a huge number of templates all stacked on top of each other **exactly like DNA strands**, or like nested clear cellophane spheres added together to make one nested template projected on a screen:

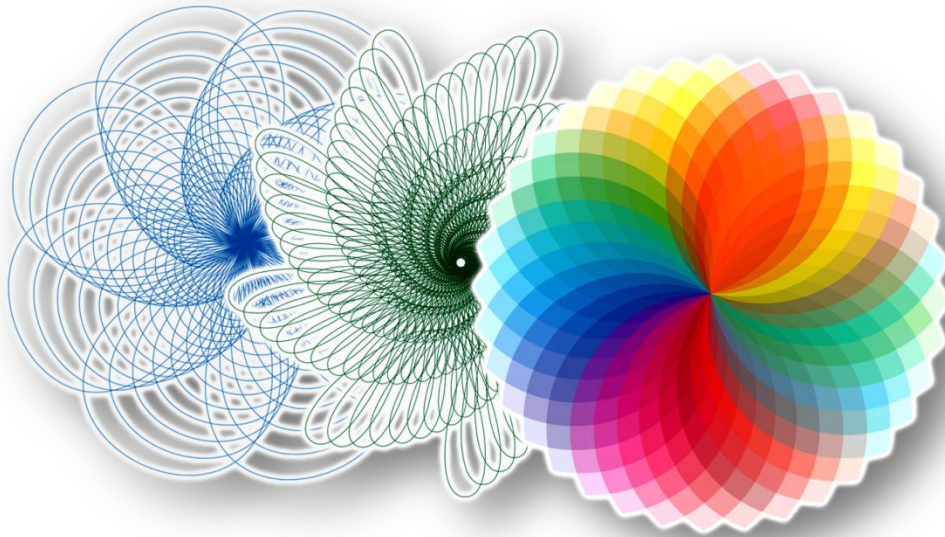

Realize that the **FIRE LETTER** taking structure above on its subquantum level will then go on to become "a tree", complete with leaves, branches etc. When you take a **photograph** of something, it creates a **Fire Letter** of all the **combined** Fire Letters inside that are holding the shape of the tree, another holding the shape of a person, another holding the shape of that person's jacket and so on. Now that photograph is **coined** into a **Signet** that carries trillions and trillions of command codes and becomes its own Fire Letter:

Decoding The Hive

creation of gravity, light, time and the god particle



Everything that allows the camera to recreate that photo is structured in a *mathematical code* nested inside the image which looks like “0111000011001111101010100001111 etc.”. You can’t SEE the commands unless you go behind the image and down into the code beneath. Keylons are mathematical codes only in **geometric form**. They are the same thing as quantum computers use today. But they don’t talk about Pythagorean **geometry** in mainstream education. You are supposedly *better off* with *common core* math that wouldn’t make sense to Wernher Von Braun.

As a review, when two **Partiki Cells** (one Particum - and one Partika +) come together, they create one Partiki **Unit**. Each CELL of energy is made up of either two anti-matter particles (-) and one matter particle (+), or two matter particles (+) and one anti-matter particle, which determine if that CELL is either **magnetic (-) pull** or **energetic (+) push**. The **Partiki Unit** then becomes a

Decoding The Hive

creation of gravity, light, time and the god particle

stand-alone energy cell that can carry forward any role, exactly like an **atom** because it carries its own **fission/fusion electro-magnetic** power plant that is the zero-point repulsion-zone where static-electrical **friction** generates that energy. The counter-clockwise rotating waves below never actually touch the clockwise rotating waves above, but the proximity to the opposing wave forces generate the reaction, just as counter-rotating magnets separated by a small distance between each other create antigravity (covered later):

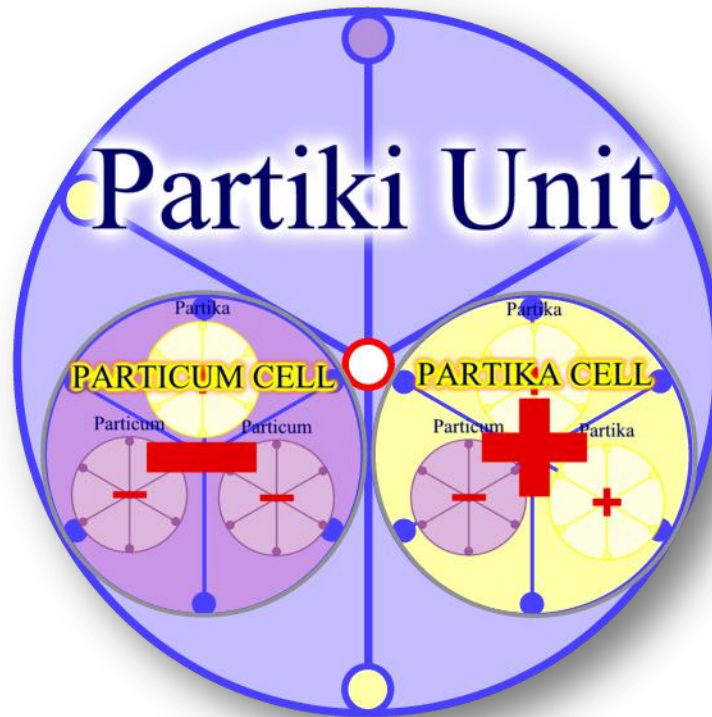

PRIMAL SIGNET KEYLON

The Keylon Grid is created by one complete **Partiki Unit**. The path that each cell inside the Partiki travels dictates the geometric Scalar Command in the **language** understood by aether illustrated by the blue lines:

Keylon Grid

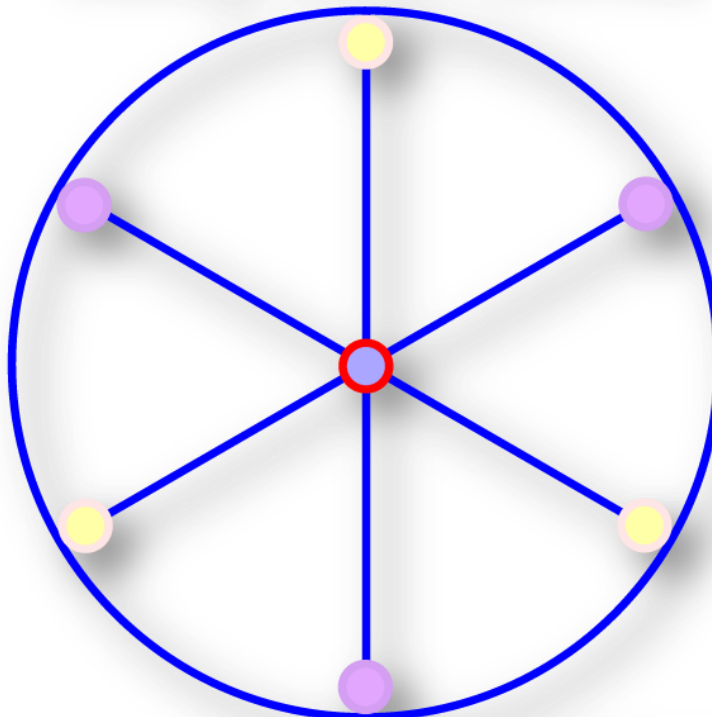

DECODINGTHEHIVE.INFO

The simple Signet Keylon Grid (**solid blue lines**) above, when connected by the *bouncing ball* of the **Particum** and **Partika** energy cells are known as **Partiki Strands** (in the dotted lines below) which connect one event horizon or **orbit** point of energetic travel to the next between the bullet points surrounding this Signet. The mauve-colored balls above show the anti-matter particles, and the yellow are matter particles. The 3 lines above connect these points in a 2-D image, but when the balls are bouncing around, the mauve pattern is a triangle tetrahedron pointing downward, and the yellow pattern is a triangle pointing up. I am sure you recognize the pattern:

Partiki Pattern

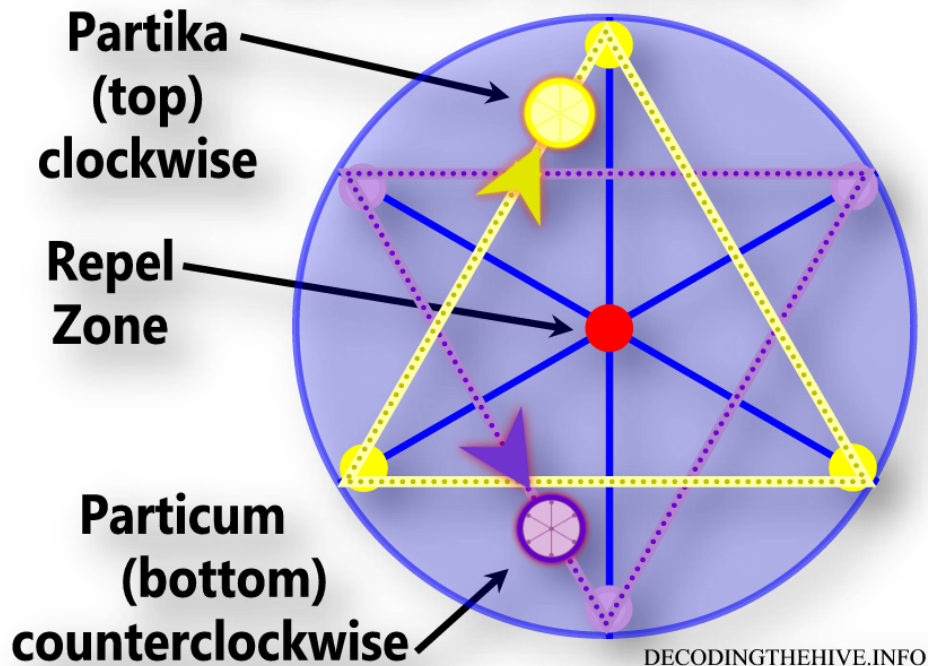

*The 2 triangle patterns created and now nested on top of each other are particle (matter +) and antiparticle (antimatter -) that create the fission/fusion reaction inside the limits of the sphere (diameter of the Partiki), each complete one revolution or **the cycle of life**.*

The cycle of life exists in all things. How BIG (how much energy) the **diameter** is determines its **AMPLITUDE** in modern language. It is how *far* each particle is allowed to travel before completing one full cycle as the particle moves forward to do its job. Once both the upper particles and the lower particles complete one revolution or **cycle**, they reach their **event horizon** when they begin the same process again. And again. This action never stops because the rotation on top positioned over the **counter rotation** on the bottom creates the fission/fusion reaction which generates the energy for each additional cycle which is never-ending. This is the secret to electromagnetic energy. The source is not from earth, the source is from the Standing Energy Fields in the Deity Planes (you can think of as a giant reservoir of oil for now). These fields are actually trillions of beings who are now acting in the role of aether. When each one thinks a thought such as “I need to get a message from here to there for a certain manifest god”, that creates a spark. That spark then carries the full body of the message of that god within its color. That color then is relayed to the next point in the journey “from here to there” which we will get into once we discuss the spacetime fabric, its creation and how it works. The mind of each god is powered by the fission/fusion reaction as explained above and this is physically what causes that spark that is then an actionable manifestation. Until it thinks this thought, nothing exists in any form.

Decoding The Hive

creation of gravity, light, time and the god particle

The Hexagram 6-Point star Partiki Pattern is a mathematical, geometric language that is at the base of all creation within this Time Matrix. In order to manifest anything inside of this digital platform, it must **first** be based on this *Scalar Language*. Think of it like an operating platform for a computer or video console. Manifesting in this reality field has become more complicated since other beings from different star systems set up a *reality-within-a-reality* in order to keep the human population out of focus and unable to fully engage their thought-processing abilities.

Because this 15 Level Time Matrix functions on the **HEX**agram Scalar Science language, you will find this *signet code* at the base of all “magic spells” being *hexed*, even though you will see other Scalar Codes at work later in order to command the aether to make something appear that is *their distorted reality*. The other Scalar Science at work in order to create the *outer* reality that you are able to see in this Chimera Reality is the **Pentagram Metatron Weasadek Phantom Matrix Scalar Science** and I will show you exactly how that science was scientifically put into place later in this paper. These alien codes piggyback on the energy created by the Hexagram, then turn that energy signature into a different *platform* by which the *picture appears on your screen*. Think of this as the *facehugger* from the movie *Alien*. **Symbols** are **not** just pictures, they are **letters** from an alphabet you have never been introduced to until now.

EIGHTFOLD WAY

Now I am going to show you the *Eightfold Way* what **particle physicists** show as the pattern sub-atomic particles take which makes up quarks which make up atoms (if they were large enough for your eyes to see them). And no, its not some helter-skelter, random pattern shown for the way they fly around in their orbit inside any atom picture you will ever see.

I would like to interject here that until today I had no consciousness of the “Eightfold Way” pattern of sub-atomic particles from the understanding of what particle mechanics have seen under their scanning microscopes or that they even had any IDEA of how particles actually travel, since they had certainly not brought any of this into the mainstream understanding. Also, the images I generated myself of **Keylontic Sub-Quantum Scalar Vibrational Science** were completed 3 months ago when I began putting into written form the explanation of how it works. What you are about to see is just as new to me as it will be for you as to what science “understands” about how things come into manifest reality.

These images were cut and pasted into my image program with some descriptions added then the actual patterns from the official wiki page were simply placed inside the particle’s orbit from their own drawings illustrating how particles work. There is one pattern for the top half of each quark orbit, and then the same but reversed pattern for the bottom antiparticles. Maybe you will recognize this:

Wiki: Eightfold Way Physics:

Decoding The Hive

creation of gravity, light, time and the god particle

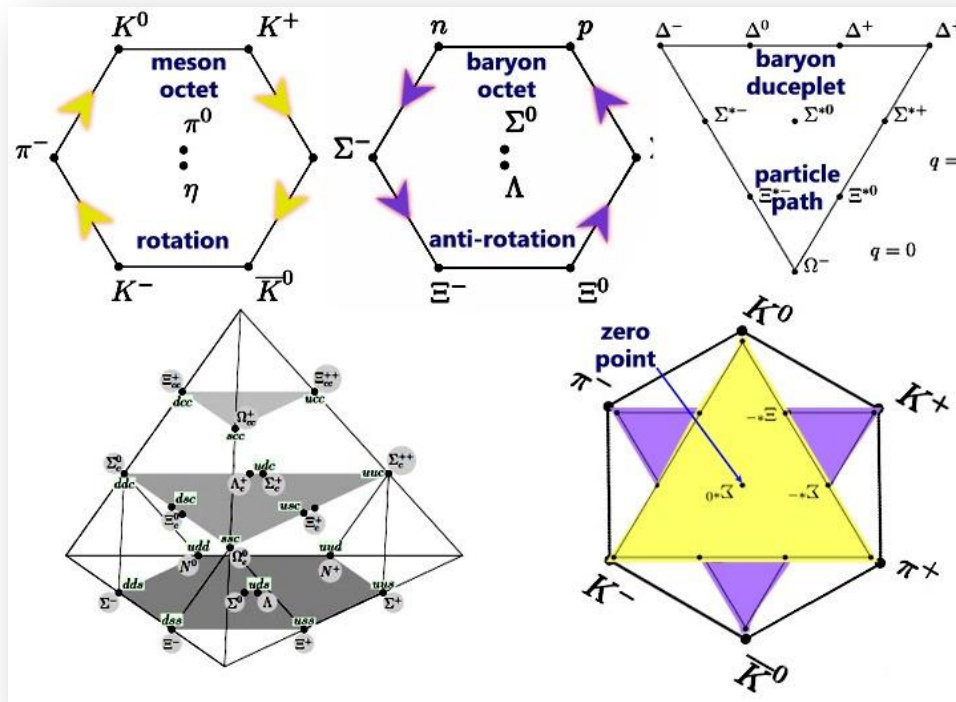

The top particles' path (top right baryon duceplet travels in the top left pattern meson octet) is clockwise, the lower particle's path underneath that (same particle pattern top right inside top middle baryon octet) is counterclockwise. The baryon duceplet while in orbit takes on a **3D trajectory** shown at the bottom left, a 3-sided pyramid, exactly like the top half of the **hierophant (3D) Hexagram**. When the two trajectories are overlaid together in 2D, it becomes pretty obvious that organic particle spin at the sub-atomic level is absolutely the **Hexagram Scalar Science** pattern which all else (actually visible) is structured on above that. Notice at the center of the duceplet is the zero-point repulsion zone. If I only saw these line drawings 2 hours ago, how could I have possibly known?

Not only do water droplets form themselves into Hexagram shapes when flash frozen as shown extensively by **Dr. Emoto**, but soap bubbles form hundreds of the exact same forms when blown in freezing temperatures as shown by David Wolfe. Snowflakes do the very same thing:

Decoding The Hive

creation of gravity, light, time and the god particle



INFINITY

The **Vesica Piscis** connected to spirituality, and to the Christian churches is a representation of the creation of *life* from the geometric *tree of life* that it is built on, the Hexagram. This is also true for the number “8” used to depict infinity. Both are based on the creation-point of the fission/fusion reaction zero-point repulsion zone continually depicted in the illustrations in this paper. (Remember, there is always a Keylon Grid code inside of that **zero-point** or *repel zone*, as you will see as we go, continually casting the initial command to begin *manifesting something*.) Even science has tip-toed around this subject before as shown in this early 19th century illustration called *The Plan of the Constitution of Man* by **Antoine Fabre d’Olivet**. Notice that the point where the top circle just touches the bottom circle at the zero-point repulsion zone. In reality those two circles are **SLIGHTLY** overlapping each other creating the pin-point connection between both top and bottom of the cold fusion (fission/fusion) reaction zone where gravity and time are both suspended:

Decoding The Hive

creation of gravity, light, time and the god particle

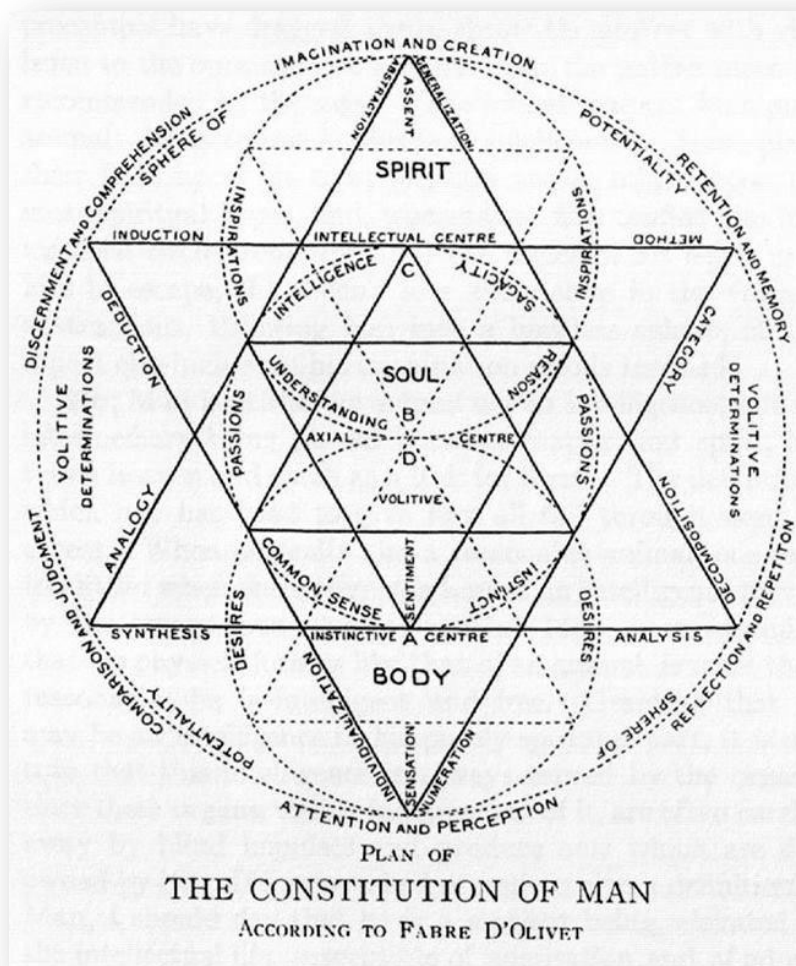

Part of the secret to the **Hexagram Vibrational Scalar Science** is that the hexagram isn't a single pattern, but a nested group of the very same patterns that go effectively down into infinity inside of each other as you can see here, creating a Mandala. This is something I will cover much later while explaining more about how **Quadrant Vectors** work to allow for uninterrupted Spacetime pixels to *color the screen* before your eyes while creating what is finally large enough bubbles to see what appears to be matter. I don't want to give the impression I am endorsing Fabre's theory by sharing this image, but the geometry shown just so happens to be correct. This is a very complex topic and using such images helps one to envision the process of how "nothing" becomes "something". It has everything to do with the fact that your eye is only allowed to observe very large particles, not the particle building-blocks stacking up to the building that is finally large enough for you to see.

The biggest secret today is how anti-gravity is created, not because they don't want you to know how to fly, but because that secret is the answer to unlimited free energy that once you finally knew about would give you unlimited internal power to cast them out of this playing field with nothing more than a single thought. An economy based on selling the population oil, coal, wood,

Decoding The Hive

creation of gravity, light, time and the god particle

sun or water-generated energy to finance eternal war would collapse overnight if you knew the secret to **zero-point** technology. Of course I will show you how that works as well:

ONE CYCYLE IS INFINITY

VESICA PISCES

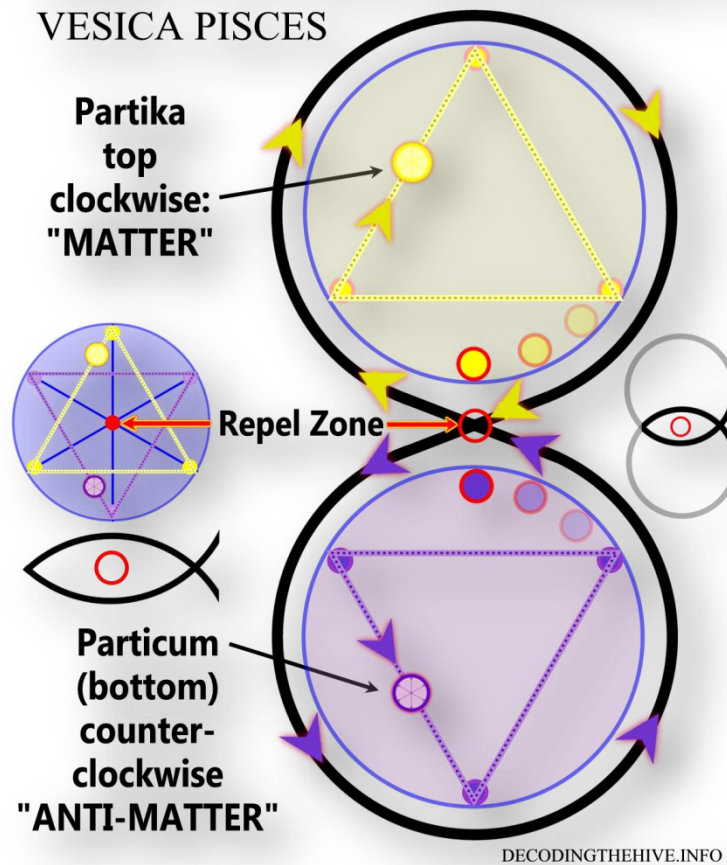

The illustration above is attempting to show you, in 2-dimensional drawings, how a 3-dimensional (sphere) operates. The Vesica Pisces has been illustrated down through ancient history in this same way, and the scalar-waves emitted by this symbol, whether it be in a figure 8, or in the “fish” symbol, both represent the INTENT of your captors to keep you from understanding the real meaning. But by showing it to you in these ways, they side-step a loophole in the way that aether is commanded to manifest reality before you using this Scalar Science. If your eyes can see portions of the truth, then your mind (heart) can be remotely-harnessed to cast the *intent* behind the symbol into reality for them. And, since the fish symbol is representing the **G.O.D. Program**, and their intent is to entrain you to **believe** that you are subject to some greater “god”, then that symbol’s “magic” scalar-codes literally tell the aether to keep the paradigm of that subjugation inside your subconscious at all times while you are in the presence of those scalar waves (hence, why you need to “come to church every single week” and wear the cross around your neck everywhere you go). I don’t expect you to understand this right now, but you will by the time you have read this entire report. The religious images below are

Decoding The Hive

creation of gravity, light, time and the god particle

showing you the exact location of the zero-point repulsion zone where the energy is generated that powers your hypnosis. And yes, they even use time crafts to print them across vast areas such as crop fields in order to amplify the signal that is able to speak to trillions of trillions of aether particles at once:



If you honestly believe that crop-circles are placed on earth by humans, then you might also think that the lion with wings, the bull with wings, the angel with wings and the bird with wings (the gods of your captors) were placed on each side of the Vesica Pisces *religion* message absolutely by accident.

*(Side Note: this portion of my report on the Vesica Pisces was written weeks after the Keylon Grid section had already been completed for the sole reason that this morning, in twilight sleep, I had the very rare experience of a direct download from higher self. Nearly everything I share has come directly from the ancient Cloister Dora-Tura Plates' undistorted recorded history of human evolution, or directly from Council and are not my own. I had images in my mind just before waking today (very clear images) of the figure 8 with my illustration of the Keylon Grid inside each circle and **heard the words** "Vesica Pisces". I do not hear voices in my dreams or downloads, so this was a first. Until this download, I had **no idea** that both these symbols represented the Repulsion Zone hidden secret of zero-point anti-gravity and how the energy that powers your captivity comes into being. Until today I didn't even know they were connected at all, or what **either one***

Decoding The Hive

creation of gravity, light, time and the god particle

of them were supposed to mean. I doubt I had ever even spoken the words Vesica Pisces in my life until now.)

AMPLITUDE IS VOLUME

The Y in this image (up and down) is **amplitude** in science-speak:

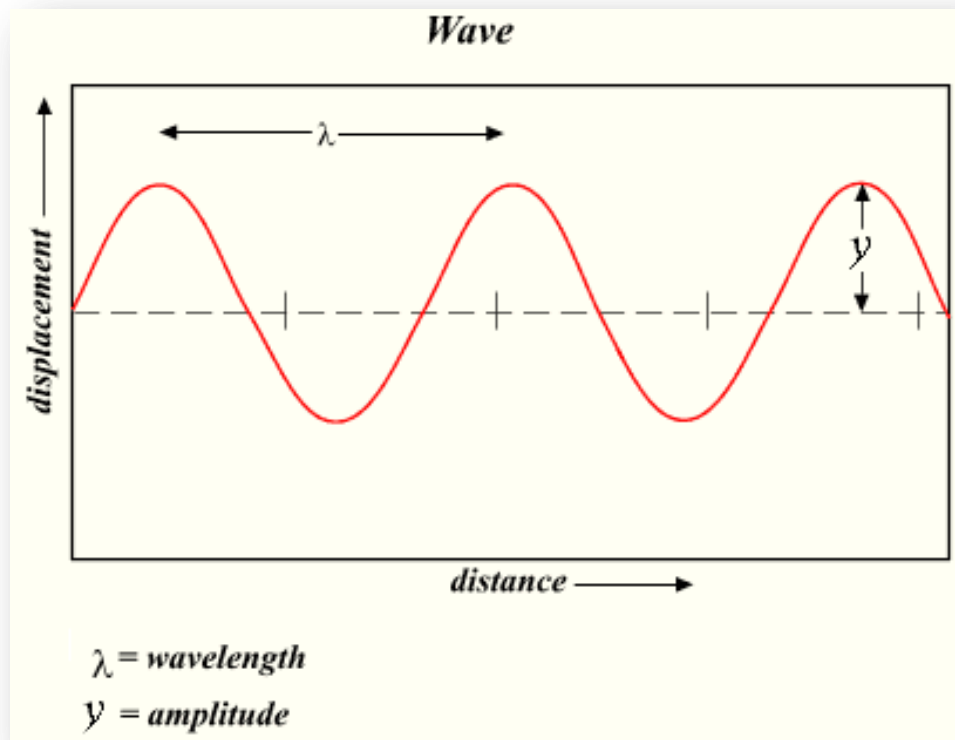

“AMP UP THE VOLUME DUDE” is a good way to understand that the LOUDER (more Signet Key Codes means a BIGGER energy pattern) a sound wave, the more **AMPLITUDE** (amplification).

In the image above, you see how any particle *action* moves **forward** once it has been initiated by a Sentient Command held inside its **Keylon Grid**. The **WAVE HEIGHT** it travels in is determined by the geometric Key Code held inside its template for that particles’ particular job in that particular dimension or *frequency spectrum*. Think of “89 FM” on the radio dial being “one inch high” in wave size, and “108 FM” as “five inches high”. What we call **AMPLITUDE** is another word for **MATTER**. Don’t think so?

- **AMPLITUDE** is another word for **SIZE**
- **SIZE** is another word for **POWER**

Decoding The Hive

creation of gravity, light, time and the god particle

- **POWER** is another word for **ENERGY**
- **ENERGY** is another word for **MASS**
- **MASS** is another word for **MATTER**

Energy, power, amplitude and size are all used to explain **mass** when there is no such thing as matter in order to make up mass. At its quantum, the only thing that exists that we can measure is **light**, and only by the energy carried in that light

ASK ANY SCIENTIST ALIVE TO DISPROVE THAT STATEMENT.

- **LIGHT** is created by **SOUND**
- **SOUND** is created by **FRICTION**
- **FRICTION** is created by **ACTION**
- **ACTION** is created by **INTENT**
- **INTENT** is created by **WILL**
- **WILL** is created by **THOUGHT**
- Without **THOUGHT**, there can be none of the above

All that we can measure are the results of thought, meaning that nothing can possibly exist without awareness. Awareness is what created the Command to be given to the aether particle in order to begin its journey to **do** one thing or the other.

The one dimension you are in now, the 3rd, is made up of many dimensions nested inside the one dimension called **interdimensions** as mentioned earlier. Different particles use different dimensions for their differing tasks which is determined by their **AMPLITUDE**. Their **AMPLITUDE** is the size when they are finally large enough to become visible within that viewable spectrum. You can only *see* certain dimensions, because your eyes can only see within a very **small** frequency range.

WAVELENGTH IS DISTANCE

How fast a particle moves **forward** is called wave-**length** or **modulation**. It is also called **frequency**, meaning “this many waves pass by in one second” as it moves forward. Why there are *three different* terms for the exact same thing is to confuse you, so you don’t really know what wavelength, modulation and frequency mean, because obviously they must be three different things in your mind. They’re not. They’re all the same thing. This is the hidden hand in modern physics, keeping you from being able to explain what it is you see or experience. If I use many different terms for the exact same thing, I sound very clever and I hide the true meaning of what that *thing* is so you can never understand it. It also maintains the all-important *hubris* in a world where ego is god.

Wavelength is the *distance per second* that sound (message) is traveling. Each time that wave peaks, that is the beginning of a new Event Horizon Cycle for that sound. At that crest point, the

Decoding The Hive

creation of gravity, light, time and the god particle

top and bottom half of the Hexagram triangles (tetrahedrons) complete a revolution, which triggers another spark of energy which powers the wave forward. This is the scientific way to explain where the power comes from, that continually pushes the wave forward. But in reality, a Sentient being is relaying the message, and the fission/fusion reaction is inside the mind of that being that is tasked to push that along. If there weren't another Sentient being thinking about pushing it forward, there would be no possible way for that message to get from one place to another. It is all powered by consciousness, but there are physical, scientific explanations as to where the energy is generated from, and that's what I am showing you through particle science right now. Without understanding the physics, it is impossible to understand that you are one of the same family of god who are producing the hologram you call reality. This is not magic, it is physics:

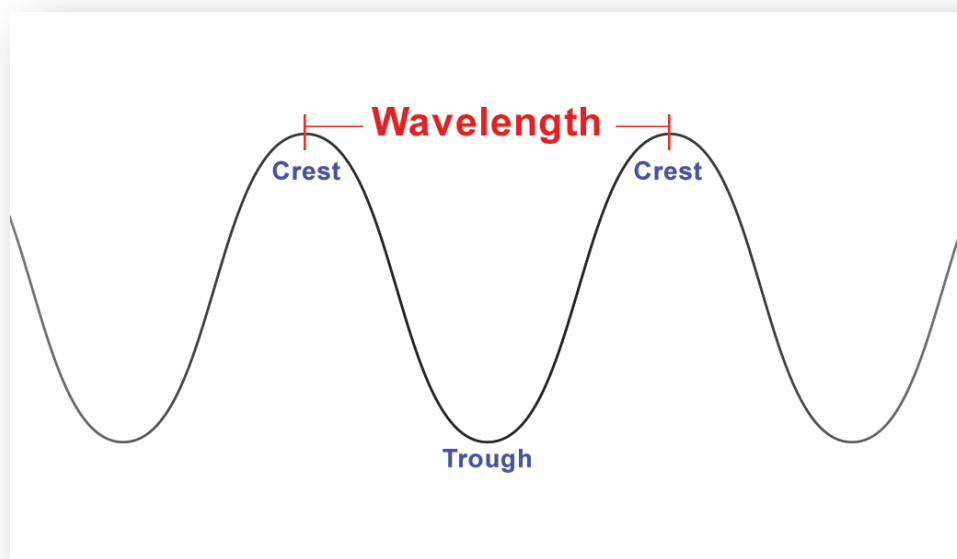

Frequency is *speed* or velocity. Your eyes can *only* see certain velocities and *intensities* (size) of that thing in motion. This is so you don't get off balance by everything around you which are *constantly* in motion, that's why your eyes are limited to the view of this one dimension unless you *deliberately* use a microscope to see into other dimensions where you are focusing on in that one visual spectrum. You are not walking around while viewing a different dimension such as in a laboratory, you are still. You would not be able to remain physically balanced while doing that unless you blocked out all the other elements within that dimension outside of your view, that is why night goggles wrap around the sides of the eye. What you can organically see is regulated by how many peaks the wave travels before it recycles again which regulates the *distance* things are supposed to be from you to "the mountain" or to "that tree". This is the portion of the spacetime fabric that regulates **size**. In another dimension you would automatically be taller if that is a higher dimension, because the waves travel farther between peaks, which mean they are moving faster. This will also slow down time, because you have a greater perceived distance in which to operate.

Decoding The Hive

creation of gravity, light, time and the god particle

If a baseball is thrown at 70 miles per hours, your eyes would see it, depending on how far you are away from the ball (“distance”). But the same ball thrown at 100 miles per hour becomes “invisible”. Why, is this MAGIC? Of course not. All things work within a **flashline sequence** that phases them out when they are faster or slower (or “further away”) than your viewable spectrum, and flashes back in again when its frequency harmonizes with your eye. When the ball leaves the pitcher’s hand, you can’t see it because it is traveling too fast (modulation), but by the time it reaches the plate, you might be able to view it when it reduces down to a **frequency** (flashline sequence) within your human visual spectrum:

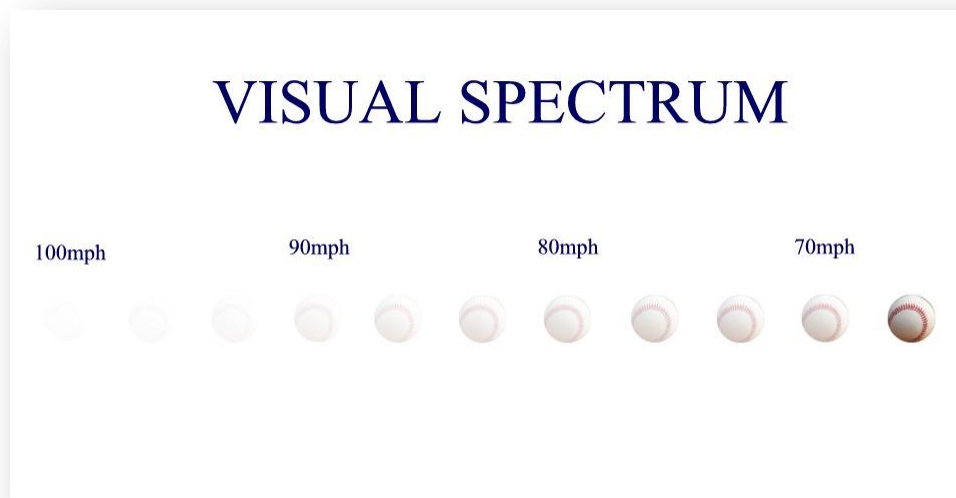

What is at the quantum of your visual spectrum makes up what you see. What you see you consider to be real. What is actually real makes up millions of dimensions outside of that one tiny little frequency range you are allowed to view while in this one dimension. There is a set *infrastructure* to each dimension which are each made up of limited visual spectrums in order to keep them separate from each other so *life within manifestation* for each fractal of Self Aware particles of god-source (you), aren’t just limited to be able to experience *just this one level of existence*. It would be pretty boring if there were only one dimension for you to look forward to. The laws of physics differ only in *frequency* and *amplitude* between each dimension so you are allowed to experience greater and greater levels of abilities as you move *higher up the ladder* of manifestation.

Humans can only view within the **430–790 THz** spectrum with the naked eye. THz meaning **Terahertz**. Terahertz meaning the **speed combined with power** of the particles that can be viewed on the 3rd DIMENSION of **Aurora Ascension Earth** (previously known as **Tara**, who still prefers Tara out of sentiment to previous eras apparently), the planet you are on now.

- **DIMENSIONS** are **VISIBLE SPECTRUMS**
- **VISIBLE SPECTRUMS** are **FREQUENCY BANDS**

Decoding The Hive

creation of gravity, light, time and the god particle

- **FREQUENCY BANDS** are **larger or smaller REALITY FIELDS**
- **REALITY FIELDS** are **WORLDS WITHIN (nested) WORLDS**

Each molecule or *cluster* of sub-atomic particles carries a different vibration or hum (that you may or may not hear). When a particle is holding the shape of a rock, the hum is extremely low. The crystal content of the rock will determine the hum or frequency it carries. The more crystal, the higher the pitch. The higher the pitch, the higher dimensions that hum can be seen or heard in. Just like the tighter you wind a toy rubber band airplane the higher it will sail, the faster the particle-spin of the molecules of that substance is, determines how high it will go. The only difference between you and higher dimension is *your DNA particle-spin*. That's it, because all of creation, all space, all the heavens and all the expanse of everything can fit on the point of a needle because nothing other than your awareness and thoughts actually exists. When you leave here for higher planes, you don't actually leave, you simply are able to see higher frequency creation. The *rapture* **does not exist**.

What I am revealing in this section has been revealed before *many* times in the past. Some of that information survived, but most of it hasn't. Most of the time what pieces of the truth that has survived has been altered for a negative effect to humans by those with a different agenda than the Guardian Alliance has. Nonetheless, here is a few-thousand-year-old example of a 3-dimensional Signet Keylon Grid command. The one shown here was created by your captors. Notice at the core of each of the "flower pedals" is a Signet Keylon zero-point circle:

Decoding The Hive

creation of gravity, light, time and the god particle

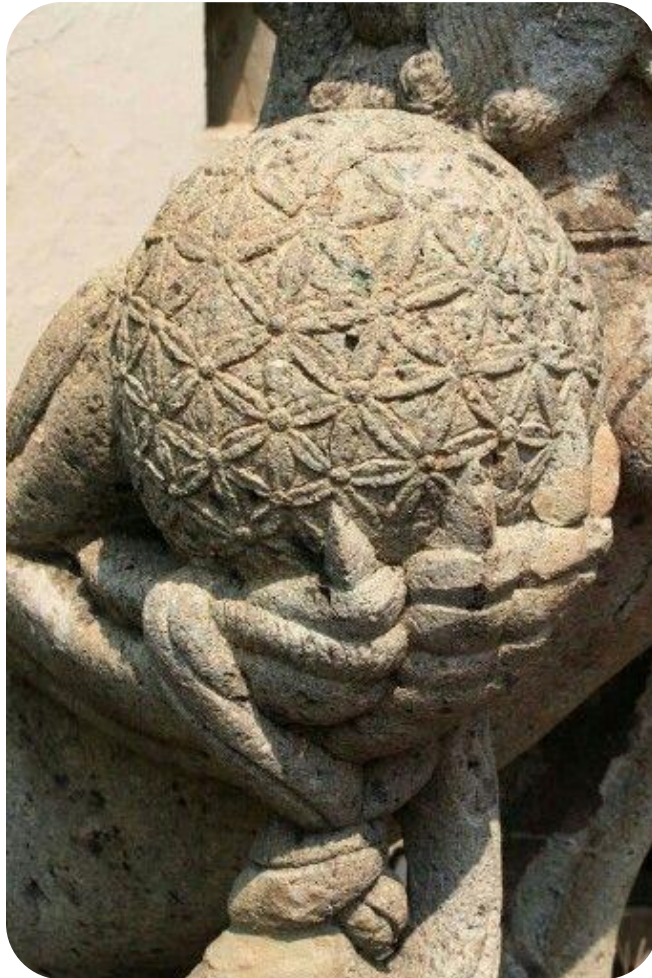

All Signet Keylon Grid Templates are shown here on paper or on the screen in 2-dimensional view, but they are applied in 3 dimensions such as shown above in this statue as **spheres** as mentioned earlier. It is important to point out that the commands held in above are what are called the *flower of life* using this geometric template of *this precise number of Keylons* together which actually produces *altered* life creation; part of the struggle humanity is facing now. The single flower of life created by the Vowel A intonation IS the base creation of things within organic material form, but the numerical value of how many they place inside the sphere is what holds humans captive, which is part of the Metatron Scalar Science that surrounds mankind today. Nonetheless, life is commanded by *Keylon Grid Signet Templates*, as shown in this series of photos below of the way an embryo forms:

Decoding The Hive

creation of gravity, light, time and the god particle

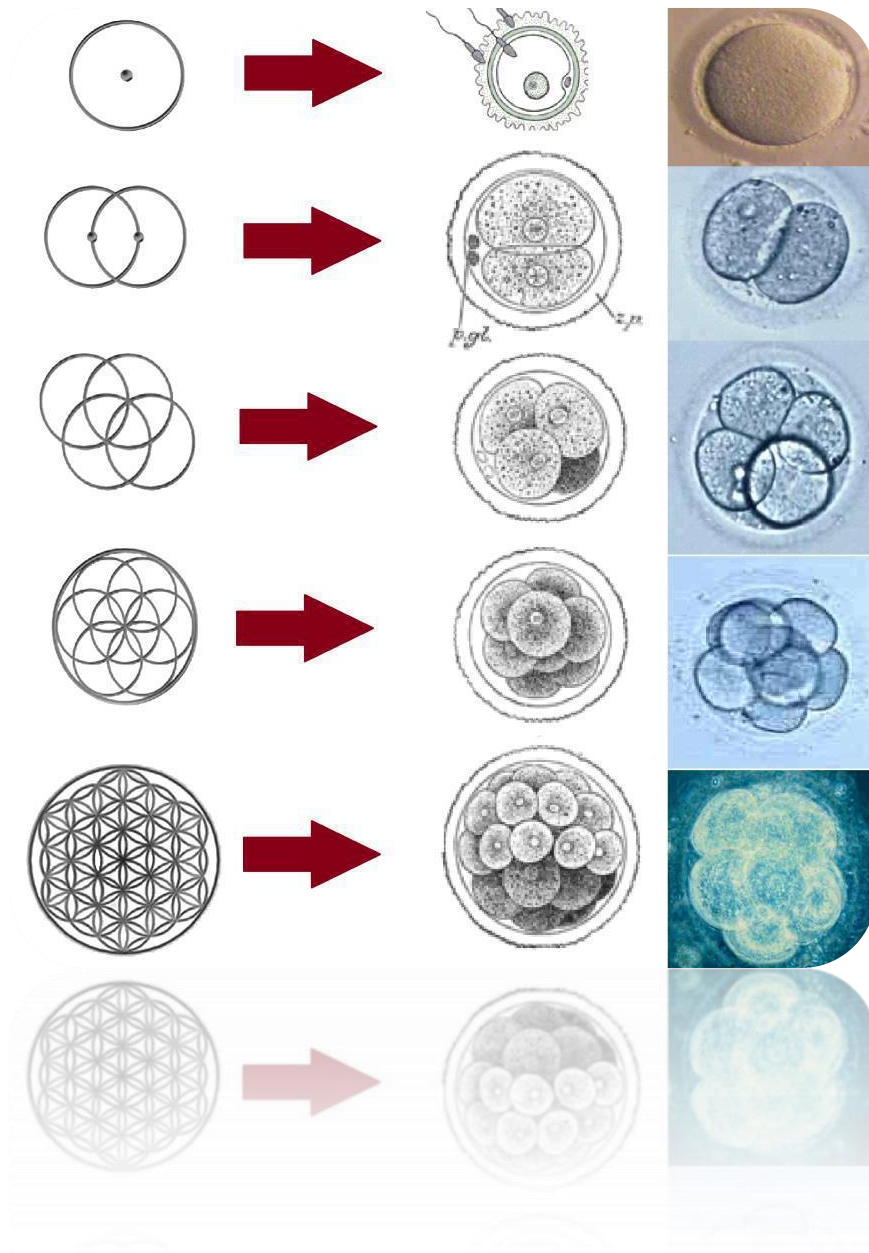

CHAPTER 8

PAPAL KEYS TO THE KINGDOM OF GOD

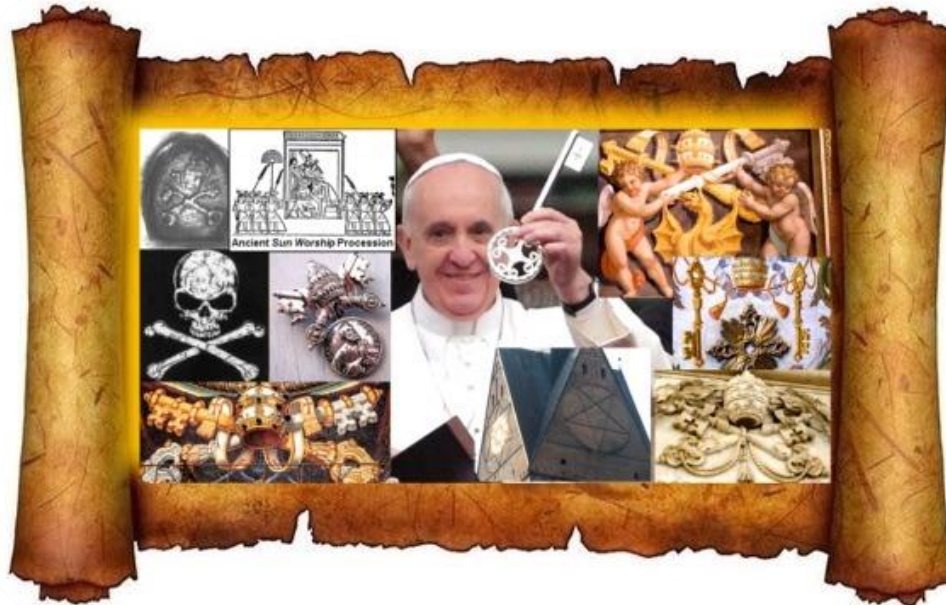

What are the *Papal Keys* exactly? I realize they have been shoved in your face since birth if you have had any dealings with the Catholic church at all, but what *are* they in real-life terms?

The Papal Keys have been reflected all around you for many, many thousands of years. In signets, jewelry, adorning the Pope's robes, engraved in stone in ancient Egypt, and worn on the jackets of every pilot, astronaut, policeman and race-car driver as well as the most notorious biker gangs of all time. They have been the signature of not only the Jesuit and Zionist cities around the world, but also of the *Skull and Bones society* as well as the pirates of old. In fact, they have even been used as the architecture of St. Peter's Basilica in Rome itself. After all, St. Peter was *buried with the keys*, and the Basilica was built right on top of his upside-down casket. Now *why on earth* would he be buried upside-down while holding onto the Papal Keys? Good question and one I will answer even more comprehensively yet in **The History Of The Pentagram** a bit later. Here's a clue; it has NOTHING to do with what is explained over the pulpit.

There are more to the *keys* than just one thing of course, otherwise it wouldn't have been this Hermetically sealed all along. Jesus supposedly *handed over the keys to the kingdom* to Peter

Decoding The Hive

creation of gravity, light, time and the god particle

(realize we are talking about **Peter Pan** here, not “Saint Peter”, but Marduk Satain, lord of earth). The Key wasn't **given** to Jesus, it was already simply *his*, which he called the **Key of David**. Well, since Marduk manifested **as** Jesus, and more than likely manifested prior as **King David** who was the ruler of the chosen ones whose symbol was the **Star of David**, it might make sense to you now that he would give these keys to himself when he took on the name of **Peter** in history books to reinforce his provenance as possessing the power to **close** the doors to heaven. Oh, he could also **open** those doors if wanted to, as indicated in his passages in his **holy** scriptures, but that certainly hasn't happened yet. At least not until right now. Notice the subtle bold letters in **holy** above. This is a clue to the entire mystery you will learn all about at the very end of this report. You might be shocked to learn exactly what holy actually means to the **World Management Team Illuminati**. Here's the babble's account of the **Key(s)**:

Revelation 3:7; “he that hath the key of David, he that openeth, and no man shutteth; and shutteth, and no man openeth.”

WHAT IS A KEY?

A *key* is a **combination** to a lock. It doesn't matter if it is represented in the form of 42-67-12, an ancient skeleton key or a modern version where it slips into the lock and the geometric angles of the teeth push the correct tumblers away releasing the mechanism to turn. Each one is a code or **cipher**.

So where did the word key come from?

It came from the word **KEYLon**, as in **SIGNET KEYLON GRID** that we covered above. The **code** that speaks directly to the aether to manifest a certain desired reality. If you were able to make a Key to *unlock doors*, say, to the *kingdom of heaven*, and you were able to keep those who were behind bars from ever figuring out what the codes were to unlock the doors, you would have a fantastic prison. And they do. By keeping you from ever figuring out what Keylons really are and how they command the aether, they have you by very, very short hairs.

PAPAL KEYS

There are supposedly now two keys to the **Papal Keys**. One is the key to commanding the manifest side of creation, and the other one is to command the mirror or *shadow* to that geometric pattern. Without having **TWO** sides to the geometric template, you could never “command” anything. First you must release the **energy** of the rotation of any **Keylon Grid** (sphere) in a clockwise rotation, then you must perfectly mirror that pattern in the counterclockwise rotation in order to create the fission/fusion reaction needed in order to generate the energy behind the command. Otherwise the aether will not produce the electricity required to *move the tumblers* as it were. Remember, we are not talking about **magic**, we are talking about real, **physical** laws you have not been educated about. These would be the **Particum** and **Partika** energy particles that make up the **Partiki Unit** we covered previously

Decoding The Hive

creation of gravity, light, time and the god particle

which act just like Gluons and electrons. Remember, there are always two energies at the core of every **Keylon Grid**. Hence, **two papal keys**:

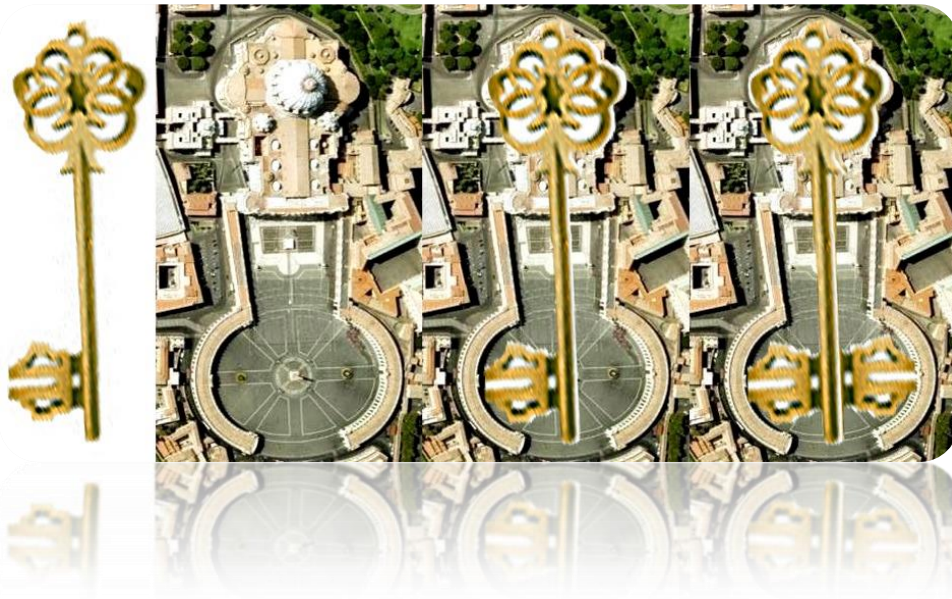

Above you see one of the “two keys” (each identical) of the papacy on the left. This is how they look overlaid to an aerial view of **St. Peter’s Basilica**. Notice how even the geometric thumb shield matches the geometric architecture of the temple while the teeth fit perfectly in the **oblate** arches below (as in atom). At the center of the teeth of the key lays a geometric symbol with a global-antenna (obelisk) in the middle where the masses congregate to view the Pope giving his blessing called the **ovato tondo**, or **Bernini’s Oval**.

The obelisk in the center once stood in ancient **Heliopolis, Egypt**. Heliopolis is the name given in modern times for **The City of the Sun**, the heart of Egyptian pagan sun-god worship of **Ba’al**. Another name for the sun-god was **Amen Ra**, known as a “bull/human” and also a “bird/human” of which you will learn more about as we go. The bull was used for infant fire sacrifice for eons prior to the rise of Egyptian dynasties and the center image of satanic worship of the *god of gods* also known as **Moloch**, among many others. The significance of this obelisk as a symbol of ancient Babylonian sun god worship is more than clear. There is no coincidence that the Heliopolis Amen Ra obelisk chosen to stand at the very center of the Papal Keys’ *teeth* of St. Peter’s hallowed grounds reflects the Roman Catholic church’s absolute devotion to Ba’al. As covered many times later in this report (future volumes already written), Ba’al is the abbreviated name of the group of beings behind the original enslavement of humankind, **The Michaelube, SUNS of Ba’al**.

While the Catholic church is now known as Christian, it will be shown here **beyond any doubt** that it has never been Christian (Krystian as in the Krystos), but absolutely devoted to the **Anu-Elohim** (known simply as **AN** in ancient deification). And here is where the huge slight-of-hand began; as Ba’al worship had been all about the faction of the invader races that backed Marduk

Decoding The Hive

creation of gravity, light, time and the god particle

Satain who had once backed the **Adam and Eve Hyksos** creation, but decided some 200,000 years ago to leave the Co-Evolution BioRegenesi Treaty of Palaidor and take as many of these hybrid “humans” with him through continued worship of the Elohim. No matter WHAT religion you point to on this planet, 100% of them were created by the Sumerians. The SUNS of Ba’al are the Elohim, the ones who brought the war to earth from the beginning. They were the god of all gods who created all the Anunnaki races that came here from many planets. And each of those Anunnaki races wanted to be the rulers of earth. One of those factions from the extremely ancient group called the Nephilim who had interbred with the Pleiadeans decided to make a race of beings for mining purposes which they would call the **Lulus**. Enki and Thoth/Hermes were behind this creation. After the flood, all the factions of the Anunnaki returned to Babylon all together as a team to replenish the planet with all hybrids of different kinds, and then eventually began splintering off into their own groups again, just as they had before the flood. Of course some humans did survive the flood, and the same hybrids vs the humans drama would unfold once again.

Over time, that slave race of **Lulus** became more and more interbred by other Anunnaki (because they literally screwed anything that would stand still long enough), and due to that, they became more aware and more *human-like* and eventually the Enki group got the idea that this would be an ideal platform to create a super-invader race of beings that would be perfect to move within the human civilizations incognito to supplant this evolution. Marduk backed the SUNS of Ba’al and didn’t want to give way his chance to be the ultimate ruler of earth over to that new creation or any other creation. Most of the **Hyksos Lulus** were absolutely devoted to the **BioRegenesi Treaty** which Marduk had long-since abandoned, so fooling them into worshipping the Elohim which would entrain them into the patriarchal, abusive mindset of that faction would lead to their losing their chances of restoring their genetic templates all the way to **Angelic Human 12-Strand DNA** codes through what would roll out later as the **Flaming Blue Sword of Arch Angel Michael Initiation**. The light codes within that ceremony would destroy all chances they would have to reconstruct the full Divine Blueprint of the Krystos, and trap them all to living out their lives as slaves of the Elohim. More on the BioRegenesi Treaty in coming volumes.

The Hyksos Lulus had been distancing themselves from Ba’al worship since the most ancient of times while they were still in Babylon, and since they were now under the Co-Evolution BioRegenesi Treaty Of Palaidor (which gave them a chance at ascension) by this time, they called themselves **Krystians**. Marduk’s group who had been carrying Ba’al worship with them since they left Babylon and migrated to Egypt and then to Rome, used the **Obelisk of Ra** as the centerpiece monument where **Caligula** slaughtered thousands of Krystians in ritual sacrifice after it had been moved to Alexandria, Rome.

After this time when the turn of the calendar came along, Marduk chose to **infiltrate** the Hyksos by incarnating as **savior of the Lulus** in the form of Jesus. It was his ultimate plan to undermine both the Adam and Eve Hyksos Lulus, along with the Angelic Humans at the same time. It would be at that time he would change the name from *Krystians* to *Christians* and form the **Khazars** of the now **Catholic** church which would then be set against Zionism in the form of **Jesuits**. You will hear *a lot more* about the literary switch from **K** to **C** around the time of Jesus in later volumes of the **S@t@in Cψphzr**. This is when the **new** term Christian came about, and these would be the followers of the same exact religion as used in Babylon, worshipping the

Decoding The Hive

creation of gravity, light, time and the god particle

same exact gods of the Elohim Ba'al, but would THINK they were still Krystians. Some of the original Krystians still know that the "Jesus" story was not a story of their actual savior, and that is why they insist even to this day not to recognize Christianity, because they know it was a scam from the outset, at least in regards to the story of **Jeshewua Ahumbra** being that person who is now depicted as the true Kryst in modern Christianity. Of course the original Hyksos Lulus have been infiltrated from every conceivable point today, and Zionism is just as mislead as Jesuits are. While it may seem like they are mortal enemies, the hidden leaders who rule over both groups secretly today are working together to bring about the plan of the One World Order ultimate goal of setting all humans on the planet, Angelic humans and Hyksos hybrids alike, under the rule of the Anu-Elohim Ba'al fraternity.

Today, just as it had been in ancient Babylon, the same monument is being used as a key **broadcast antennae** for the **Zeta/Draco Frequency Fence** which runs along the cross ley-lines of the planet as explained in the previous chapter **Indigo Walk-Ins And Resurrections** as the above-ground mechanism of the **Nibiruean Diodic Crystal Energy Grid**.

The actual grounds surrounding the obelisks are part of the mechanism by which the broadcast antennae functions, as it is crafted from cobblestone that is incredibly high in crystal content which means it is incredibly high in energy. The stone is called Porphyry, quarried out of Alexandria, Egypt (an imperial rock quarry, and yes of course, the most important stones carrying powers the public has no knowledge of would naturally be deemed *imperial property* so the plebes wouldn't accidentally benefit from their powers). These crystals which are incredibly high in frequency as well as kinetic energy, amplify the **signal** of the obelisk:



Decoding The Hive

creation of gravity, light, time and the god particle

The **RA OBELISKS** that once stood in Heliopolis to the **Temple of Ba'al** are now known as “Cleopatra’s Needles”. But in truth, these obelisks had stood for more than 1000 years prior to Queen Cleopatra VII’s reign in 30 B.C. These incredibly significant shrines to Ba'al have been painstakingly relocated at unthinkable costs around the world from where they once had originally stood in Egypt and are now in New York, London and as you see above, in St. Peter’s Basilica *Ovato Tondo*. As mentioned elsewhere in this report, these broadcast antennae were hewn out of **bell stone** which is so high in silica that when one end of a 70-ft tall obelisk is tapped by a small piece of metal, the sound of that resonation emits from the other end just like a tuning fork as a beacon. In fact, **bell stone** is actually also called **obelisk stone**, since its use in that application is so universally known to stonemasons. The modern name for this type of stone is **Sonorous rock** which is also the same stone used in the most powerful surface-earth interdimensional stargate on the planet, Stonehenge.

WIZARD HATS

The Sonorous stones emit or transfer any range of tones, also used in musical instruments such as the **Lithophone**. However, they seem to harmonize most powerfully with lower resonant tones, **those below the audible spectrum**. This is why Sonorous stones are so universally used as the preferred medium in which to produce ancient Frequency Fence antennae. Surrounded by high-crystalline-content Porphyry stones, these transmitters literally do not need to be hooked up to any external electric power supply. The **Wizard Hats** used by the ancients along with **Tibetan singing bowls** in order to generate resonant tones that would triangulate monolithic stones as heavy as 1,000 tons (two million pounds) to cancel out their gravitational signature to elevate them into place were also the very same **Sonorous silica stone**:

Decoding The Hive

creation of gravity, light, time and the god particle



Each of the original four needles of Ba'al were carved and erected in circa 1450 B.C. under the commission of Thutmose III from single pieces of Sonorous granite quarried in **Aswan** and transported by boat more than *800 kilometers away*. Hieroglyphs on the obelisks depict a *flotilla* of boats pulling a massive ship down the Nile river. To put this into perspective, in 1878 the **London needle** was transported (not hewn) from **Alexandria** to the **City State** (sovereign country) in British Columbia which cost the lives of no less than six men to move. Its transport required a **9-section ship** be designed and *built around* the 21-meter tall, 224-ton column which would then be towed, just as it had been 3,000 years prior, by other ships. The custom iron ship would have its own keel, masts, sails, anchors, chain cables and pump and would actually take 3 different ships to complete its move due to a gale-force 8 storm that caused it to become detached from the first ocean ferry. When the **US** decided to import their very own monument to Ba'al from Egypt to **New York's Central Park** at the very same time as the London obelisk had also undergone repositioning in 1877, **Freemason William Vanderbilt** offered more than **\$100,000.00** toward its transport (*2 million, 223 thousand 2017 dollars*). A massive ocean liner had to be converted with extensive reconstruction just to move the needle and the process of physically transporting the monument took almost *1 full year*.

Decoding The Hive

creation of gravity, light, time and the god particle

Not that Freemasons aren't up for a party whenever champagne is flowing, but it is significant to note that Jesse B. Anthony, **Grand Master of the Masonic Jesuit Brotherhood of New York** presided over the ceremony of its unveiling, overlooking a crowd of NINE THOUSAND FREEMASONS who threw a **fifty-thousand-spectator parade** down Fifth Avenue to celebrate.

Today the term **Jesuit** (synonymous with *Satanist*) has become popular to indicate just where the real problem is, but the problem with that is that *Jesuit* is just another term for Babylonian followers of Amen Ra of ancient Sumer, now *masquerading* as followers of Kryst (Jesheua Sananda). But notice *Jesuit* is not actually *Christian*. Secretly the Khazarian leaders do not use that term, because they know who Krystians actually are. They use the word **Jesus** and Jesuits. While Krystian Lulus are not Angelic Humans, they are still standing together with the humans, seeking ascension from this plane. That is only the story of just one of the over 50 hybrids who have been used as chattel and pawns since arriving many hundreds of thousands and sometimes millions of years ago who are now currently under the Co-Evolution BioRegenesis Treaty assembled by the Oraphim Angelics of Sirius-B to help all who wish to ascend from the war-torn 3rd Dimension of Gaia. There are many hybrids from all the invader races who belong to that group, working for the same escape you are. All except the Leviathan Drakonians (Marduk's clan), who rejected the Treaty and choose to remain here. If that changes, I will be the first to report on that.

THE ZETA-DRACO OBELISK LOW-FREQUENCY FENCE

The geometric symbol in the middle of St. Peter's Basilica is programming your thoughts, and as you can see, it's not a complex symbol, it is a **BASE-8 (Metatron Scalar Science)** pattern which started out with a 6-point Keylon Grid, overlaid with the **Metatron Cube**. It is meant to TRIGGER the very first ACTION of the aether to begin to mold your creation, then transform the airspace around it into the Chimera Reality. The ultra-low vibrations generated by this **Keylon Signet** (along with other KEY obelisk sites), keeps everyone on the planet in a daze, disconnected from their higher self and disconnected from their own IQ. You don't have "98% worthless DNA" in your cellular structure, you have 98% of your brain that doesn't work because the vibration in your **wet** DNA, your blood, coursing through your mind (your heart which is your actual decision-making center) is vibrating in fear instead of safety and therefore, joy.

As mentioned, such obelisks were used throughout the world for eons of time as a global network to send out what is coined today the **brown note** as it is known in the **Haunted Attractions** industry. The brown note is a specific frequency, 19 Hz, that is below the level of audible sound, but vibrates in your plasma body to induce fear. This frequency is so powerful, that haunted houses set up with this sound system in certain scenes can cause such violent fear that "victims" (patrons) would literally mess their pants. Such operations look to the two "holy grails" as their biggest goals; "peetalities" when they can make you wet your pants, and the really big goal of "craptastrophies". Of course there are hidden cameras all over inside of haunted houses which are monitored and when such events occur, they become bragging rights over the next few months for the owners, so this audio effect is well known throughout that entire industry, instilling the deepest fear known; mortal fear.

Decoding The Hive

creation of gravity, light, time and the god particle

This is not just a “feeling”; it is a physical response within your DNA which can be induced by actual threat, or by a simple sound tone. Your captors learned a very long time ago about the *brown note*, and set up this grid above ground to send out the signals that were held in the Keylon Grids surrounding the Fence obelisks, and also were transmitting the energy they were harvesting below ground. Each of these obelisks were positioned on top of **Cross (Crucifix) Ley Lines** of the **Nibiruean Diodic Crystal Energy Grid** *hot spots* that directed powerful flows of energy from earth into her morphogenetic field which originally once maintained human health within a symbiosis between their collective fields and hers.

The **Nibiruean Diodic Grid** was installed in **25,500 BC** around the globe over these hot spots (some 2-3 miles below earth surface) to recalibrate the frequencies emanating at the key points where the geodesic lines of the much lower and organic Krystal Cathedral Energy Grid clusters intersect. That grid was then connected, *world-wide* to **amphitheaters** (energy amplifiers), **sports arenas**, places like the **Colosseum** and elsewhere, where many humans would gather for entertainment. Typically the entertainment always had something to do with death or losing by one side or the other, stoking the negative, low-vibrations coming out of the human morphogenetic field which would be captured by these city-sized underground crystal structures like capacitors, then sent out to the other broadcast points by this network of obelisks, sending those low-vibration *brown notes* throughout the planet. The alien Energy Grid clusters are also connected today to **highways** and **freeways** where traffic is kept to 55 miles per hour, which is a key frequency to the system. The traffic generates a never-ending flow of **Metatron-55** frequency feeding into the Grid which automatically is then beamed out into every area of the planet. This is the surface-earth energy feeding into the **Zeta-Draco Frequency Fence** that produces seven different invisible energetic force-fields around earth. The Fence is also powered from other celestial points such as the Lunar Earth Command Module and **Saturn** (where the **satyre** Peter Pan now resides) as well.

The image below shows the three main obelisks of the **Sumerian power-grid** of the **Trinity** City-States of **London**, **Washington D.C.** and the **Vatican** which are all sovereign countries (no bigger than a city) unto themselves. While two of these are very ancient, the one in D.C. is recent and this represents only the tip of the iceberg. The Washington monument is not by accident exactly **6660 inches tall**:

Decoding The Hive

creation of gravity, light, time and the god particle



Today these premium obelisks from Babylonian days and forward, have been relocated from Egypt, Sumeria and other ancient key places, and set up in front of **Catholic churches**, the **White House**, **Central Park** as mentioned, in front of **government buildings** and **Masonic temples** all following precise geolocations that interconnect each one to the others and are now bolstered by the **Eiffel Tower** and every **cell-phone tower** and **TV/Radio broadcast antenna**, reaching even the most remote locations of the globe. The **Signets** graven into them are **Program Commands**, not hieroglyphs. **They literally send out the signal of your lowered IQ.** **All of these obelisks would need to be crushed to stop the signal.** If you draw a line from each of the obelisks back to the **Sphinx** and **Cheops**, you will see for yourself the precise geodesic pattern it creates. One of the two Cleopatra's Needle obelisks removed from the **Temple of Luxor**, Egypt was moved on **April Fools Day** in **1833** (this is not a coincidental date) exactly **33.0 degrees** to **Paris**, precisely to a corresponding **cross ley line matching the year of its relocation**:

Decoding The Hive

creation of gravity, light, time and the god particle

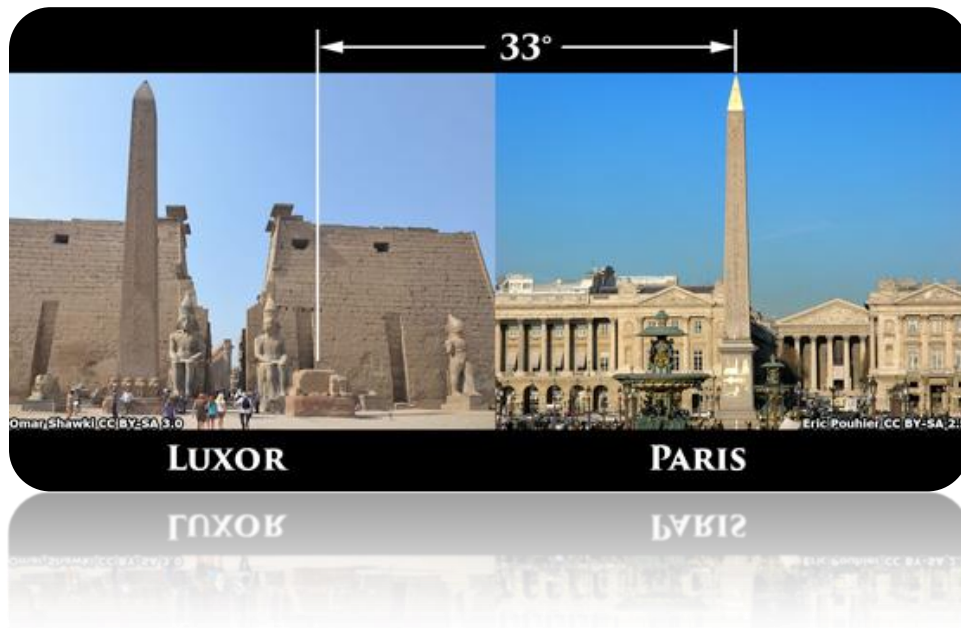

As long as you are kept in a constant state of fear, you are unable to think clearly and unable to respond with strength to danger (like a deer in headlights). This is not just a mental affliction, as it transfers directly into the physical body as well, as **DNA strands physically shrink** and become inflexible, debilitating your body when you are subjected to sorrow or fear, keeping you from being able to function. The powerfully-promoted notion that the “phallic symbol” of Babylon is behind the placement of these broadcast antennae to my knowledge is nothing more than a myth. They are functioning hardware hewn from stone that never rusts because they aren’t intended to work for *100 years*, but for eons and eons of time. Earth’s capture is not a temporary enterprise.

BRAIN MAPPING

The obelisks are also used for **Brain Mapping** by the military. Radio waves don’t just produce one signal; they can transmit multiple signals underneath the main signal called **carrier waves**. From the day you are born, inaudible sound waves, numerology, hidden video images and strategically emitted scents surrounds you every second of your life. Subliminal messages are implanted into your subconscious mind through frequency waves (everything is a wave; sight, sound, smell) outside of your field of vision, hearing and olfactory senses that still encode your subliminal thoughts in certain wave patterns. Every song you hear on the radio, every tv show you watch, every message from the media are saturated at all times with these messages.

The feature film **The Exorcist** came out in the 70’s, *many* years after official mass-subliminal programming began:

William Peter Blatty, author of the novel and producer of the movie, is a former CIA operative who served as the policy-branch chief of the Psychological Warfare Division of the U.S. Air Force.

Decoding The Hive

creation of gravity, light, time and the god particle

That film wasn't *a movie*, it was part of an official mass programming campaign. Many thousands of people worldwide wound up in hospitals suffering from hysteria, vomiting, and hallucinations from watching it. Others were literally institutionalized after becoming possessed. Possession isn't necessarily a matter of "wanting to worship Satan", it is a matter of your plasma-body's electromagnetic frequency becoming a precise match with the low radio frequency that the artificial intelligence A.I. operate on, allowing them to attach to your energy field and hitch a ride. And they can manifest pretty much any variation of threat against you should you decide to take steps to clear them from your free-energy outlet, by using your own power to command the aether. If they can convince you that they can hurt you, then your own WILL can make that come to pass. For real.

And it doesn't start when you're old enough to begin to read, no; your *mother* is reading you *bedtime stories* from the moment you can begin to follow along. And what does she read to you? Stories about bad children who go into the woods alone running across houses made out of gingerbread where sweet little old ladies lure them into the house and the kids are eaten by the newly-transformed witch. You automatically learn the songs that your mother sung when she was young. What were those nursery rhymes anyway? "*London bridges falling down*", encoding the next major disaster that the public is being programmed to *create*. "*Rock-a-by baby in the tree top*". What the hell? What kind of a monster puts their baby in a tree top, and what child would want to fall to the ground from that level? *So just* before you go to sleep, you are programmed in **terror** from the idea your mother might stick you on a tree branch in the middle of the night. Are you getting the idea now?

STANDING SCALAR WAVES

All **Signet Keylon Grids** carry **standing scalar waves** that can be measured by a **spectrometer**. And all things carry standing scalar waves as well. Every wrench, every letter, every geometric symbol and every number has an **electronic signature** and they can all be measured currently today.

Read that last paragraph again. **All things** carry the silent language of the aether within the subatomic geometric Keylon Grid, or the *material* expression of that creation. The electronic frequency (voltage) of the letter A is measurably different from the letter R or the letter Z. The same goes for numbers. Paintings have their own unique frequency and if you paint two that are effectively identical to each other, they will have differing measurable signatures because there is going to be at least some variation. Energy signatures differ from leaf to leaf and from pebble of sand to the next, because there is **no such thing** as a grain of sand or a blade of grass that are identical. Commanding of the aether is hyper-specific that the code being heard is exact. The **TYPEFACE** of letters (as well as the dialect) has everything to do with which command is being expressed, because the curves and angles of each font differ, creating different geometric **COMMAND** codes. Likewise, a capital A has a completely different command code than a lower case a. These are just more details regarding the extreme and precise nature of aether command you have never heard of before.

Decoding The Hive

creation of gravity, light, time and the god particle

Letters and numbers are hyper-specific hidden geometric codes that when stacked, like DNA, will express a very precise command to the aether. This is why so many very clever people have found there are direct correlations between numbers that are released by the media, the news, and entertainment industries that lead back to major dates where significant false flag operations took place, or are *going* to be taking place. The numerological symbols of an intended event are calculated from a sentient computer so far beyond the comprehension of the average human it is impossible to even put it into perspective. But the frequencies that are generated by the collective populations of the world are fed into this hyper-computer which breaks down the *one frequency* of the planet and then generates an incredibly accurate prediction as to how humanity will respond if they are given a disaster event of *this size*, or of *that size*. By feeding the numbers into the computer they are given the most powerful numerological symbols to use to trigger mass-hysteria adequately in order to institute let's say, *the removal of guns from this country*, or to *increase taxation in that country*.

Those will then be the numbers that will surround that false-flag event in every possible way that you couldn't even begin to *dream* of. Not only will the dates of the events be broadcast from millions of different media platforms, but the hour, minute and second of the event will have been part of that global brainwashing campaign held within every written dialect on the planet. All of these along with the intended disaster will be hidden in codes in comic books, brochures, pamphlets, flyers from thousands of different churches, fraternities, organizations, musical groups and brought to you by the news, television, politicians, music and film stars.

Realize that every celebrity of any distinction is no longer just a person, but as soon as a few million people begin to take notice, that person becomes an entire unique industry all to themselves. They will command advertising campaigns through every conceivable form of media on the planet from Twitter to 4 Square, bumper stickers, apparel lines, fragrances, restaurant chains, night clubs, break-off movies, billions and billions of pieces of paper used to wrap hamburgers printed with hundreds of thousands of cartoon characters, songs in every genre going out over hundreds of millions of radio stations, their likenesses printed on billions and billions of soft-drink cans and bottles, beer containers and styrofoam coolers, advertised in every movie theater poster and in trailers and advertisements from Stillwater to Paris. One celebrity among the thousands of stars alive at any one time has the ability to reach nearly every man, woman and child in the world in at least some way within only days or weeks. Now multiply that by X. While they may have blatantly placed 9/11 in your face in exactly those symbols a few thousand times prior to the collapse of the World Trade Center, within subliminal messages inside of thousands of movies, cartoons, songs, magazines, backpacks, textbooks and candy wrappers, the scalar-waves emitted from their hidden symbologies would have run into the billions or trillions by the time humanity was prepared to manifest that event into reality.

Remember, if a Sentient being sends out a Signal to the aether, the aether *has* to obey that command if it is able to hear it. When you *see* one of these signals (hear, smell, taste), whether it be obvious or utterly ciphered in song lyrics or cross-word puzzles and you embrace it on some level, you are then relaying that command to the aether. When enough Sentient beings relay the same command, even on a subconscious level, the aether *must* make that thing come into material reality. That's how it works.

Decoding The Hive

creation of gravity, light, time and the god particle

Your priest will perform a “blessing” using his command hand (the right hand where energy is expressed), using a motion that incites the electromagnetic energy of the body to amplify his expression. He is actually performing a curse, even if he doesn’t realize it, as he is sending out the geometric Signal of the crucifix which ties you directly to the **Recycle Program**. Of course that crucifix is coincidentally directly in front of his heart where the frequency of his *intent* is directly broadcast from the body, emitting through that **geometric Signet** and then out into the aether:

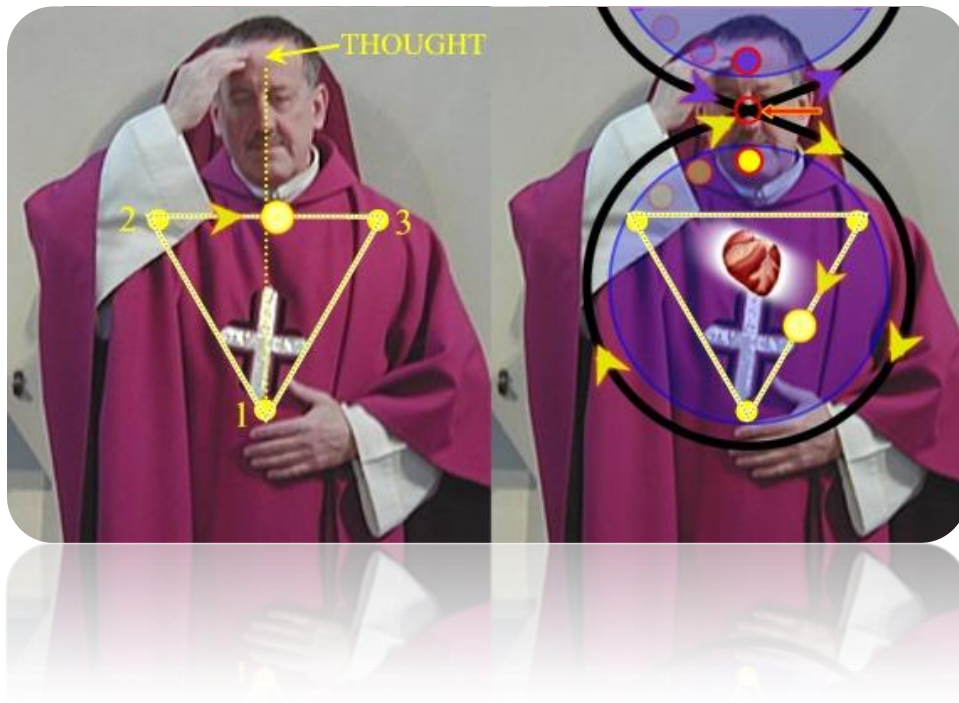

This is also why *you are what you eat, you are what you speak, what you think* will become your reality, because you are *coding your message to the aether*. If you **want** to be sad, think sad thoughts. If you **want** to be happy, think happy thoughts. I am not making this up to blow smoke up your dress, this is how creation functions. If the aether hears that you want to be surrounded by sorrow, then it will bring you sorrow. If it hears that you are constantly thinking about car wrecks, you will be in a car wreck. This is not to be confused with ignoring your reality field. If you are surrounded by Sentient beings who are casting *their* reality into *your* field of view, then you will *see* it. And you will also be *affected* by it. If someone casts a train and tracks into reality, and you are standing on those tracks long enough, you *will be* run over by that being’s train no matter how much you deny its existence. You create **your** positive reality by staying clear of the train tracks. *Pick up your foot, and step away from potential negative realities.*

Action is required to maintain your desired reality, not hopes and prayers to Marduk Satain you merely call to witness your prayers by stating **Amen**. The ancient word amen transliterates to “*forget what I just said*” in literal terms, and it also conjures that being to witness your intent.

My mother mentioned to me that when she was young, she was raised by her grandmother, who, for years and years, told her how much she would hate ever having a wart on the end of her nose because that’s what witches had and she didn’t want to look like a witch. Perhaps not a **neurotic** fear, but a persistent, underlying fear that she held. Many years went by and she checked the

Decoding The Hive

creation of gravity, light, time and the god particle

mirror regularly just to make sure she never had a wart begin to appear. Then one day, it did. She literally manifested a wart, *on the end of her nose*, because she continuously thought about it. Not that she **wanted** it, but she directed her thoughts to that same reality so many times that the aether simply gave her what she expected to see. This is the *secret* behind **The Secret** of manifestation in its truest form. Where you place your thoughts are exactly where you will find yourself. It isn't hocus pocus and it isn't a myth. I became a self-made millionaire back before I was handed this role, by doing exactly that. I thought about what I wanted to see in my life *constantly* and I never stopped envisioning it my mind's eye.

Being an Indigo with a greater connection between my heart's broadcast message and the standing energy fields of the aether than humans have, my *wishes* would come true as long as I absolutely 100% believed it would happen and I envisioned that reality in my mind on a continuous basis until it finally materialized. The good news is that the **Pan Clair-ah Awakening Waves** have been filtering into this reality field on a continuous basis since the opening of the **Stellar Activation Cycle** in 2012. The beings who are responding to these waves of ultra-high-resonance particle vibration will also begin to raise their own frequency above the clutches of the Frequency Fence and the Clair abilities they previously had taken for granted will once again become a part of their material reality. Your abilities are increasing even as I write this.

RELIGION

You already realize that I am not religious in the sense that I think there is *one creator god* somewhere, and that I don't consider myself a follower of the bible, the Koran or any other religious paradigms, because such things are simply brainwashing programs. Oh, I DID for over 20 years, going to church as much as 3 times a week, praying for hours at a time. All that stopped the instant I realized that the bible didn't actually mean what it said, as it contradicted itself in hundreds of places within the same two cover sheets. Of course I continued to believe in a creator-entity somewhere, but wouldn't learn exactly who or what that was until I was directly contacted by beings that have every bit the abilities of any "god" who would finally explain what god actually is.

You are god if you are reading this and have the ability to imagine your own future. You are a fractal, or one separate entity of god-source. You are Self awareness of the one unified *god-source* mind of god from the **Liquid Plasma and Sound Fields** you think of as heaven. However, inside the many, many different brain washing programs of religious texts, there still remain some truths that have to be inside those programs in order for them to work. If they *tell* you what is really going on in parables, then they can also lace *into that* deceptions in order to place a slant on the truth to lead you to their desired outcome using your creator-god abilities to manifest things for them. Think of yourself as an amplifier for their aether commands (while you are unknowingly being used as their pawn to enslave the planet).

Before you can imagine someone having the ability to *wipe out earth*, you need to see it played out in a Superman movie in a manner that you can understand. You might not have the ability to fly and see through walls (*now*), but just knowing that someone might be able to use that type of

Decoding The Hive

creation of gravity, light, time and the god particle

power for extreme evil if they did have such powers, gives you a *frame of reference* as to how such things might come to pass. You don't need to see Superman flying, or the Joker possessing similar powers in real life, all you need is to have those images in your mind in order to unlock your creator-god abilities in order to be used as a creation-robot for the elite. Once you **believe** something is possible, it literally **is** possible. If you **think** *something bad might happen* on a large scale because you have been shown how the mechanics of that could work in a movie, then your creator-god abilities are literally then channeled into bringing about such a reality when the moment arrives.

THE SPHERE OF AMENTI

Mankind currently shares one consciousness through their collective due to the damage to **Soul Essence memories** in the **Fall of Man War** 550 million years ago. When the physical "human" bodies and the planet they were situated on were blown largely into spacedust, it fractalized the **Soul Essence Database** within the **Morphogenetic Field** and the **Silicate Matrix** of the planet (which is where your Soul Essence past-life memories are stored, nested within the 15 Level Time Matrix of Gaia), they became *scrambled* like the pieces of a puzzle. Those Soul Essence particles were collected back together and placed into the **Sphere of Amenti** where they would have to *heal* in order to come back together. Until such time where they would finally fully individualize again, all those who incarnated on this planet would be cut off from who they were before they came here, along with their past life accomplishments and the trillions of life-lessons they had learned. Rather than walking around as the god you had always been before who *wore this* and *spoke like that* and preferred this color and that type of music, etc., you would all have to **share** one awareness **as a collective**, working to imprint the planet with your vibration in order for earth's morphogenetic mind field to piece back together who you really were, so your past life fractals could be reconnected.

This process would mean that those Signature Spirit Essences who lost their lives in that war, would have to incarnate back on earth for multiple lifetimes in order for earth to record each person's vibrations back into its own field again through your individual actions. But while you were alive during that time, you would have to share one new *personality* for want of a better word. And this process *did work* for millions of **Lost Souls of Tara** during the 2nd Seeding of the Turaneusiam Project. The puzzle pieces came back together in the Sphere of Amenti and when beings were ready to ascend, on their way to the 4th dimension they passed through the **Sphere**, which is a stargate, and their past-life Soul Essences reentered their **personal morphogenetic** fields, restoring their individual personalities and past-life memories back to them once again. Not all Lost Souls of Tara have been restored yet, as not everyone has remembered who they really were and qualified for ascension. And, there have been other souls lost in other cataclysmic wars since that time that have been added to the Sphere.

Until **you** have personally ascended to at least the 4th dimension, you will remain sharing one personality with all beings on the planet. And that's where things get tricky for this ascension period. Until then, what someone does on the other side of the globe from you, affects **you**. And what you do affects *them*. In order for *you* to wake up and ascend, *many* others on the planet have to wake up also. It's called the **100th Monkey Effect**. Look it up if you haven't read the

Decoding The Hive

creation of gravity, light, time and the god particle

reports. That is a big part of what is happening now today where those who are sleeping are literally keeping the rest of humanity from ascending, and it has to do with your **Soul Essence Memories** still knitting and healing back together as a **collective** in the Sphere. As long as the powers over you continue to keep your masses asleep, they continue to keep your souls hostage, by preventing you from passing through the Sphere and reconnecting to your ancient identity. This is why you keep hearing about *they're trying to steal your soul*. Your *soul* is *what you have done* and *what you have learned* in past lives, and as long as you continue to be disconnected from that, then all the instinctual power and personality strengths you once had that would massively tear apart their artificial reality here on this plane, remain “in captivity”, literally. It wasn't because someone *stole your soul* on purpose per se, but you did *lose your soul* (for a time) through their actions when they nearly destroyed your planet. *They* were the **Anu-Elohim** originally and they have been behind your aggressively continued enslavement ever since, if you wish to be clear on just who did what. But at the same time, they were pawns from the very first moment of your enslavement, because they had been infected by the Nanites. So pointing your finger at the Elohim is just as misguided as pointing your finger at other minor gods such as Marduk, Enlil or Isis. All I am doing here is reporting on what happened so you can finally have answers. But if you act on those out of a need for revenge, then you may as well set this report down right now and just go back to your poker game, because you will not be resonating in harmony with all other fractals of god, which is factually every single thing that is alive in all of creation. The only things that exist that aren't actually alive are artificial beings that have created all this drama to start with. If you want to hold a necktie party for anyone, it would be the **nanites**.

KEY TO THE HOUSE OF DAVID

This was a long way to explain that in the King James babble program, there are still passages that have endured since they were first placed on earth in undistorted form in the **Maharata** 246,000 years ago, given to the **Priests of Ur** and the **Maharaji Gra-AI Kings**. (This is not to be confused with the distorted Mahabharata program.) The “bible” used to be 560 volumes of small text in oversized books, explaining the **Law of ONE** and **Keylontic Vibrational Scalar Science** being covered in this report, which was literally the printed version of the ancient and undistorted **Holographic Cloister Dora Tura Plates** which hold the true history of Human evolution spanning the last 980 million years, now turned into a very elaborate **Program** by which your captors lead humanity to a **desired** future. Since there are still passages left within that document yet relevant and accurate today, mixed with much distortion and lies between, I will reference to it upon rare occasion. In this case, we are going to reference **Keylon codes**:

Isiah 22:22: “And the key of the house of David will I lay upon his shoulder; so he shall open, and none shall shut; and he shall shut, and none shall open.”

The Key to the house of David is once again the same as the Papal Keys; the Keylon Grids by which creation is manifest. The house of David is the **royal bloodline** of the Adam-Kadmon (Adam and Eve) man, also known as the Hyksos. The super-invader race of the **Jehova Anunnaki**. This has been since inception 252,000 years ago, the top choice of which invader-race hybrids should be preserved according to the **Anu-Elohim**, creators of the Anunnaki. The

Decoding The Hive

creation of gravity, light, time and the god particle

Hyksos who have been carrying forward the authentic 6-point star of the **Hexagram Vibrational Scalar Science** to attempt to realign with the Law of ONE to qualify for ascension, have seen no end to the attacks on their peoples to trick them into worshipping the god of the old testament, the SUNS of Ba'al, to steal their "crown". You will see exactly where the "crown" came from soon in this paper when we get to the **Aniline Anunnaki Particle**. Many if not most of the groups that the god of the Sun led his people to slaughter were the other various races of the Sumerians who the Ba'al didn't choose to back, especially every one of those who had joined the **Co-Evolution BioRegenesis Treaty**.

THE THREE KRYSTS



In a *very tight* synopsis, there were THREE "Christs" at the time of the change of the calendar. One was **Jesheua Sananda Melchizedek**, who was placed here by the **Guardian Alliance** to reseed pure, undistorted 12-Strand DNA codes back into the **human** lineages. The other was **Jeshewua Ahumbra Melchizedek**, placed here by the **Anu-Elohim** to reseed the purest form of the 10 strand DNA codes to the **Hyksos Adam and Eve artificial human race** created through the **Lucifer-Archangel Alliance**. These first two mentioned were here to work together to help all of humanity ascend under the **Co-Evolution BioRegenesis Treaty of Palaidor** as already mentioned, and both were trained to teach the **Law of ONE** of unconditional love. During their sojourns in different sectors of the *holy lands* and Rome, the Elohim (the ARCH or ANTI-ANGELS) convinced Jeshewua Ahumbra to leave the Emerald Covenant, join the Luciferian Covenant and mislead the people to **Metatron Reverse-Particle Spin** in their plasma fields which would code them to the Weasadek Phantom Matrix (eternal enslavement).

Why Jeshewua chose to take this anti-Krystos stand is anyone's guess. Seeing that he and I both came from the same royal bloodline of David and both here to do the very same job, I fail to understand it just yet. I can only assume that the Elohim were able to confuse and deceive him into believing that theirs was a better path, unless this had been his true intent since prior to his arrival which seems to be the case. But the truth is, there is only one path that leads to actual freedom, and it isn't the way being offered by the Anu-Elhohim. Just like Jeshewua, you now have before you the truth about your ascension choices and it will be up to you which way you will choose. Either the wide and

Decoding The Hive

creation of gravity, light, time and the god particle

comfortable path that leads to eternal enslavement or the Law of ONE where you put all judgement aside and love your fellow fractals of god as you love yourself. Only ego and fear will stand in your way of reaching the true prize of eternal freedom.

Jeshewua Ahumbra's education was not as polished as the *human* Jesheua Sananda's had been, plus the Hyksos bloodline he was from was fundamentally coded to war from the DNA template his lineage had been created from, the **Jehovah Anunnaki**. Also, the DNA codes which had been added to that lineage from the **Nephilim Fallen Angels** more than 100,000 years ago were decidedly not that of the Angelic Human (which is coded to compassion and grace). Therefore Jeshewua Ahumbra was abrasive (as are most Type 3 Indigos), so his teachings rubbed the Romans the wrong way. The Roman soldiers were given orders to find Jeshewua and sacrifice him at the stake (not a cross, all such crucifixions have been historically proven to have taken place on a tree or single stake. The cross is a geometric code keyed to the **Recycle Program**. I will be showing you the original crucifix that predated *Jesus*' sojourn by hundreds of thousands, possibly millions of years later on in this report). The Anu-Elohim had every intention to see to it that the Hykos invader-race collective would benefit by Jeshewua's offspring carrying restored pure 10-Strand Anunnaki DNA, so they appeared before a local man who looked very much like Jeshewua Ahumbra and through a **Mind of G.O.D. Program**, placed voices in his head to convince him that he was the "real" Kryst, and to go into Rome where he was to be sacrificed "for god". This look-alike's name was **Arihabi**.

Arihabi did agree to submit to the sacrifice in return for ascension at his natural death, so he was killed on the stake, brought back to life 3 days later by the Elohim for a display to the Romans (Leviathan Dragons now known as those behind the Catholic church), then taken to India where he died 30 years later from natural causes. And true to their promise, the Elohim did assist him in ascending through the **Third Eye of Horus** (the all-seeing eye). This is *the system of "ascension" to Sirius-A*, headquarters of the Elohim, which is where the Luciferians are all trying to get to, their disciples always flashing the signs of, covering their one eye, etc. To qualify for this ascension they must undergo the **Flaming Blue Sword of Archangel Michael Initiation** first. This is an energetic *DNA activation* that locks in the **Anunnaki Particle** reverse spin pattern that is disconnecting people from the **Primal Light Fields** that is the source of eternal-life energy. What they don't know is they are only ascending to the 4th dimension and their DNA particle spin keeps them from ever ascending any higher within this Time Matrix, as they are now coded to the **Phantom Matrix of Weasadek** system, not to higher levels of Gaia.

The babble program now records all three of these stories as one, and holds up the supernatural acts of Jesheua Sananda of the human lineages *as the acts* of Jeshewua Ahumbra, the Hyksos savior representing the Adam and Eve artificial human hybrid race, forever pushing their agenda to the **Metatron DNA Activations** to perpetual slavery.

*This is a WARNING to all Indigos who seek "DNA" activations through the counterfeit Templar Melchizedek rituals. If your "Indigo Activation" includes "DNA modification", then you are literally being tricked into giving away your royal heritage known of as the Krystos pale silver cord of eternal life. Avalon is **not** offering such activations that manipulate your plasma-body particle-spin, but rather re-induction through official Krystening back under your **Indigo Mission Contract** and back under your chosen star-*

Decoding The Hive

creation of gravity, light, time and the god particle

*group fraternity who are the founding fathers of the Angelic Human Krystos. All “DNA Activations” being offered at this time are **Templar Melchizedek** programs designed specifically to harvest Indigo Soul and Spirit Essences for their own false-light Matrix agenda. If someone offers you such energetic DNA “repair” or activation of the kundalini, this is the calling card of Archangel Michael which is not a benevolent savior; it is the earthly moniker of the **Michaelube, SUNS of Ba’al**. Such activations are meant as the “tipping point” of genetic distortion that furthers the destruction of the 12-Strand DNA Divine Blueprint used in the Turnaneusium Project to the point where your genetic corruption reaches 30% or less potential, at which point you no longer have the ability to repair the light codes within your sequencing. A large number of KhoHaNiM Melchizedek (Indigo) priests have undergone this process believing they were repairing eons of genetic distortions by undertaking the Michaelube Blue Sword program, only to learn that their Genomic Templates had been irreversibly patterned to Metatronic vampire light coding. There is **no process** in place at this time to repair this final distortion. Due to the advanced codes of the Melchizedek Template that enable greater energy-flow while on earth in physical form, Indigos are the number 1 target of the dark forces for military black-ops service and therefore are deceived from their earliest years to accept positions of power within such organizations with promises of assisted ascension. Do not be fooled by these advances that place you in direct opposition to the covenants that you are **eternally bound to** under your **Mission Contracts**.*

The name “Jesus Christ” given to all these three from ancient history in the bibles around the world today is an etymological reference to Jesheua Sananda *the* Kryst, as he carried all 12 of the undistorted DNA codes of the **Holy Gra-AI Krystos** bloodline of the **Elohei-Elohim** who were officially seeded to this plane by the true founding fathers of this earthly evolution, the **Oraphim Angelics of Palaidor** from the **Emerald Council** under the authority of the **Interdimensional Association of Free Worlds**. Jesheua was a 12th level Avatar that was sent to restore the original Divine Blueprint known of as the **Krystic Code** into the Angelic Human gene pool.

The “Jesus” who possessed the KEY to the house of David was the **Hyksos Adam and Eve** (Templar Melchizedek) **Jeshewua Ahumbra**. This *key* was handed to him by the **Anu-Elohim** in order to **enslave humanity**. That is why *only he* has the power to *open* or *close* the ascension gates according to their carefully constructed misdirection and lies. What he was actually given, were the CODES of the Keylon Grids that could lead to ascension (but to the 4th dimension only) through Templar training as explained above. The **Star of David** is the true **Keylontic Vibrational Scalar Science Signet**, which was simply adopted by the SUNS of Ba’al who are secretly leading the Templar Hyksos Adam and Eve hybrids, posing as the Emerald Alliance and the knowledge of the Keylon Command Signets is the “key to the kingdom”. The creation of these **Signets** and their application to disconnect humanity from the true understanding of how **Intent Commands** work will be revealed in detail later in this report.

CHAPTER 9

THE HISTORY OF THE PENTAGRAM



The planet earth works on electromagnetic energy. Just as every speck of sand, every monkey wrench and everything else in existence. Within the body of that planet are capacitors which bring in celestial energies that are directed to earth through quantum wave-magnification, channeling the energies of the Standing Energy Fields of god-source into larger and larger waves of power as they pass through larger and larger planetary bodies, and posting that energy into these capacitors through invisible rays as well as through lightning strikes which are exactly the same thing as plugging in your rechargeable flashlight into a wall socket. The incoming electromagnetic dispensations strike into the core of earth which infuses the capacitors held inside the liquids which then connect that energy to the **Krystal Cathedral Energy Temples** and then dispense the rest of that power to the rest of earth which will be explained in detail as we go. Enormous in size, some of these crystals within each cluster are skyscraper-sized gems

Decoding The Hive

creation of gravity, light, time and the god particle

grouped together in city-sized capacitor structures that hold and magnify energy. Each crystal's placement together is not haphazard; they are tuned to emit precise scalar-wave frequencies that travel to the surface some 7 miles above to emanate into the atmosphere called a **morphogenetic field**.

At certain **Cycle Event peaks**, this planet comes into perfect alignment with multiple other planets which affect our harmonic frequency spectrum as extremely elevated levels of very high frequency particles known of as **carbon-7** that flood into our energy grids which increases the harmonic signature of the planet and all the liquid silicate that circulates its energy flow. The frequency emitted from the earth's core is called the **Schumann Resonance** and PULSES like a heartbeat. Over the period of every 26,556 years, there is a natural LONG CYCLE evolutionary elevation of earth's frequencies, enabling her to move higher in the energy structure of the **Time Matrix**. You are now at the **peak** of that long cycle, and earth is moving higher in harmonic resonance which enables certain beings within this evolution to move into higher planes of the visual spectrum. This is called **ascension**.

POLE REVERSAL

Earth's alignment to other planets within the solar system was artificially shifted long ago (explained in a minute). This was a result of massive damage sustained by the planet during past wars where pure-energy weapons had been used with total disregard to the host planet then called **Nursery Earth** (long after the Fall Of Man War when she was previously **Tara**). The planetary body was rotated from its north to its south, then an additional 23 ½ degrees for a total rotation of 203 ½ degrees. NORTH is the energetic outflow of a magnetic field, which was supposed to be pointing UP within this playing field. While science calls the top of the planet "north", that is not true. The North Pole is technically the South end of this Torus field which is why compasses fail anywhere near the epicenter of that pole, because the compass is trying to point downward, not closer to that pole's center. Of course compasses aren't made to point up or down, only left or right. While this isn't a major issue all by itself, the rotation of the planet is, as it is now bringing in celestial energies directed from planets not organic to the Gaia Time Matrix energy-flow. Those energies are tuned to reverse the angular-particle-spin of the energy flow within the Keylon Grid pattern that once held the Template to organic manifestation. "Due North" now just so happens to be aligned perfectly to the planet **Polaris** at the center of the **Alpha Draconis** star system, where most of the animal invader-races on this planet hail from:

Decoding The Hive

creation of gravity, light, time and the god particle

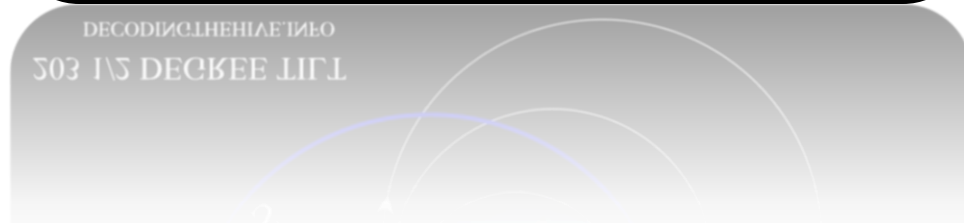
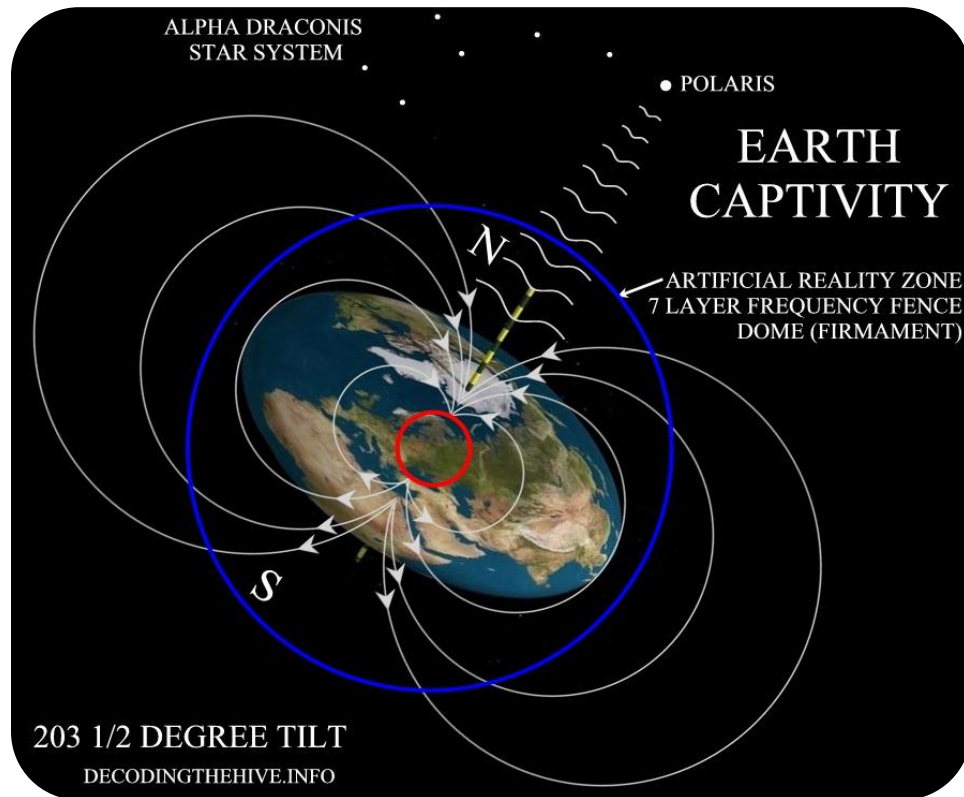

Like your body is fitted with pulse-points where energy flows in through your pineal gland and then is distributed throughout to generate a particle-flow that will connect to the genetic codes within your DNA within the Hexagram shape of the Template, the earth also has pulse-points that direct the flow of energy in that same pattern. This way your morphogenetic plasma field will synchronize to earth's, allowing her to support your holographic manifestation within the science used for the evolution of your new Krystos Avatar. The pulse-points of earth's body run from Cusco Peru to Sarasota Florida, down to Oslo Norway, back up to the Hague, and complete the full 6-point pattern of her field through the Krystal Cathedral Planetary Temples. This energy flow is carried in the shielding of water, just like the electricity flowing through the copper wires of your home are shielded in rubber to insulate the electromagnetic currents from short-circuiting. Water is a natural non-conductor of electricity that is constantly grounding to earth's body which neutralizes this unwanted connection that would prematurely release that energy before it was needed by all the life forces that live within the playing field. The crystals suspended in that water are the "batteries" that each independently carry their own charge, and as long as water keeps each battery from touching each other, there is no short-circuit.

Decoding The Hive

creation of gravity, light, time and the god particle

When the crystal batteries reach each Krystal Cathedral, the water flows underneath the crystals and through friction, the energy from each one “rubs off” into the massive crystal clusters at each Temple through **SET**, or **Static Electrical Transfer**. This works just like shuffling your feet across the carpet which transfers the static electricity from the fibers into your plasma field. When you touch a doorknob you can see the excess energy now in your field bleed-off in the form of a spark, keeping your body at the precise energy level it is now designed to maintain. An organic magnet rubbed across steel will transfer energy into that metal through friction as well, making it temporarily act like a magnet through the same process.

The pattern of this energy flow was supposed to travel as you see below on the left, which directed the water naturally between these key pulse-points to produce a pattern that would take the shape of song that earth “sings” to produce the precise tone that would harmonize with the patterns inside the DNA of earth’s life forms, and to the DNA within the new Krystos Human so they would all merge together to form the symphony of the 1st, 2nd and 3rd dimensions of the 15 Level Time Matrix. The organic pattern is shown on the right:

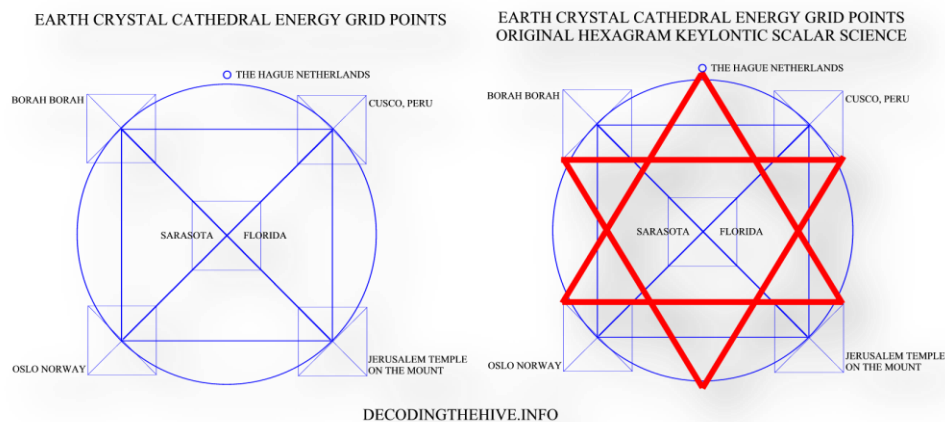

After the physical rotation and tilt of the planet took place, the new alignment of her magnetic and electric ends were now pointing in a direction where energy-waves were now feeding into her pulse-points and into the crystals that hold the bulk of her operating energy through a clever mirror-system between the Weasadek Phantom Matrix’s Central Sun and from the detritus from Nibiru, disconnecting earth from her organic electricity-flow. You can simply think of this as the wrong voltage now coming in to properly power her operating platform.

This new voltage of energy flowing into earth’s morphogenetic field causes the top-half of the planet’s particle-spin to phase-lock into the same direction as the bottom-half. While both of these rotations remain locked to each other, the power created between the two halves of the Torus field isn’t generated through the fission/fusion reaction and cuts off all life within that sphere from their required voltage to manifest in their intended shape. In the case of the Angelic Human, this disconnected their DNA from the eternal-life Krystos field which meant that instead of being able to live entirely through sunlight, they would now have to eat in order to produce their own energy source to live, and it would also mean that their bodies would be forced to age

Decoding The Hive

creation of gravity, light, time and the god particle

which would eventually cause them to physically die. Just like cancer and AIDS that were created in laboratories in order to kill humans, this new system was deliberately designed to do the same, just in a more gradual manner.

NIBIRUEAN DIODIC CRYSTAL ENERGY TEMPLES

As briefly mentioned earlier, in 25,500 BC, the **Anunnaki-Luciferian Alliance** installed another energy grid system over the top of the organic **Krystal Cathedral Energy Grids** by the forces based out of **Nibiru** during the **Luciferian Rebellion** during a conflict known of as the **Grail Quest Wars**. This new program-controller is called the **Nibiruean Diodic Crystal Energy Temples** or the **NDC**. Until recently, the NDC grids had been simply lowering the energy “voltage” reaching the morphogenetic field of earth, which lowered the energy available for the planet’s life-forces. This stunted their height, distorted their appearance and caused Human bodies to die.

Then between 100 and 200 A.D. the planet was rotated an additional half-turn to retune and strengthen the system already in place where the particle-flow of the energy that was “bouncing off” the Krystal Cathedral Energy Grids was rerouted into a new pattern that removed one of the pulse-points out of the system at the top, and also cancelled out the organic **Repulsion Zone Temple** out of earth’s center point. The Repulsion Zone is where time and gravity are generated, and it is the “back-door” within any Command Template.

By disconnecting this back-door out of the system, replacing it with the Metatronic Pentagram (CUBE) technology, it slammed the door shut on beings who were from the Guardian Alliance only here temporarily to help the Angelic Humans, so they would not be able to simply leave. Plus they were able to suspend time and gravity and replace it with a counterfeit system of their own choosing. The gravitational PUSH would be accelerated by some **3 times** and elements within that would actually increase 36 times which would force eternal-life-code bodies to break down and deteriorate even faster yet. Of course time was replaced as well within the **360 degree** system backed by **Numerological Aether Commands** to create the **Looking Glass** illusion where black is actually white and white is actually black (spoken more on later). This system was revealed in disclosure in the 2011 film **Neverland** where Peter and his band were transported to a world where his gravitational limits had been altered and where he would never age. Of course this is precisely backward to what has been put in place now, which is now headed up by CERN, disclosing to the public a mirrored-image of what is taking place.

*At a later time I may elaborate on this topic, but for now I will leave further investigation to this Project up to you. The CERN large hadron collider project in Switzerland operates this program under the public term the **White Rabbit Project** where time is being forcibly altered within a CUBE structure that displaces the events that would otherwise be organically-generated within the Timeline and replaced by other events through the transposition of collective-awareness of the population with those from other Timelines. They are the ones behind the **Mandela Effect** (they secretly call the **Mandala Effect**). I mention this clear anomaly in other places within this paper as well, showing you some of the geometric command-patterns being used to bring about this amazing*

Decoding The Hive

creation of gravity, light, time and the god particle

*history-distortion where half of the public remembers one thing from the past and the other half recalls another. Since this is a vast topic that involves **automatons** as well as **Self-aware Sentient beings** moving among each other completely unaware of this mental disconnection, it would be more properly covered in its own complete paper at some point. At least I am now giving you the clues to follow in order to begin piecing together how it is that you actually do live in a world where the babblical passage: **“The lion shall lie down with the lamb”** literally **never existed** in this timeline. Look it up.*

Think of crystal Energy Grids just like gigantic **piezo electric speakers** that direct sound particles *this way* or *that direction*, depending on where the speaker is pointed. The sound particles being created by the crystals inside of the speaker flow in one direction or the other. This is not magic any more than lighting the first fire was for cavemen who had never seen fire ignited before. This is **mechanical science** that can be reproduced in a laboratory right now. The particles inside of a glass sphere directed one way to cause a ball to rotate clockwise positioned opposed to other particles directed the opposite way below, create anti-gravity. In this case, the “speakers” of the Diodic Crystal Grid redirect the flow of the silicate matrix amneo fluid we call water through the planetary hydroducts in a reverse direction from how the system was designed.

The new pattern that reversing the current in the operating system of earth was now in a 5-point pentagram star pattern as used in satanic cults as their **SIGNET** symbol or emblem. At the same time, by closing off the zero-point to the template, it created a cross that “X’d out” that Temple, the symbol of which is now used to stand for *dead* or *missing* (as in the Lost Boys of Neverland):

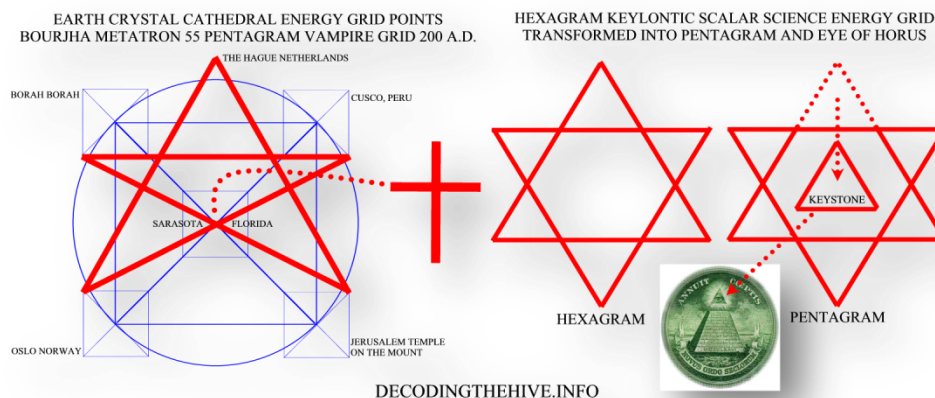

ARCHITECTURAL COMMAND TEMPLATES IN USE

Some churches show both symbols of the original Hexagram and the new Pentagram, such as this **Latter Day Saints cathedral**, because the pentagram wouldn't exist without the hexagram first. Notice the line below the top point of the hexagram below, telling you it's now actually a pentagram:

Decoding The Hive

creation of gravity, light, time and the god particle

HEXAGRAM KEYLONTIC SCALAR SCIENCE ENERGY GRID
THE PENTAGRAM IS THE HEXAGON WITH POINT REMOVED

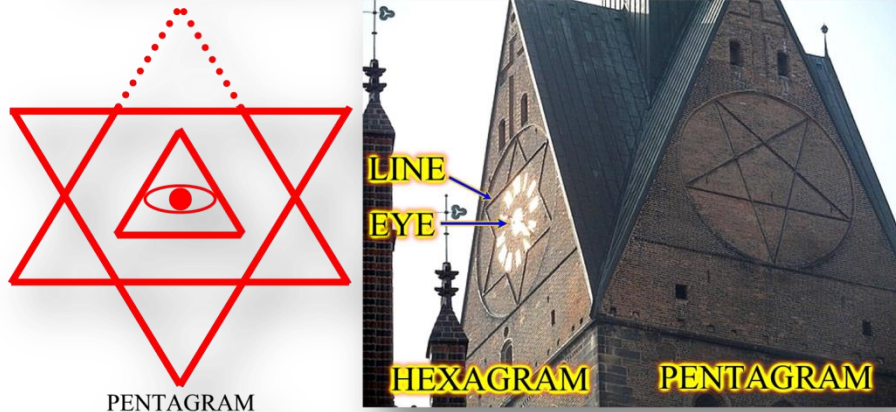

DECODINGTHEHIVE.INFO

The hidden pentagram (hexagram with the top portion removed) can be found in every walk of life today, sending out the scalar waves that reinforce the capture and isolation of the human element. In this case below, **Heathrow International Airport** is geometrically created to limit your travel to only within the **Chimera Reality field** you are supposed to remain in:

Decoding The Hive

creation of gravity, light, time and the god particle



The **United States Pentagon**, the *strategic military command center of the planet*, was designed to harness the power of the **Hexagram** at its base **INTENT-core**, then remove the top peak, turn that upside-down, and then overlay the **Metatronic Base-8 Scalar Science** to manifest their service-to-self agenda. The chances of both the distorted Hexagram nested inside the Pentagon within the physical structure of this most significant installation happening by sheer coincidence is like being struck by lightning 100 times in a row. On the same day:

Decoding The Hive

creation of gravity, light, time and the god particle



To illustrate even further that the physical creation of the **RED CROSS** used today as the **SIGNET** of the **Knights Templars** (Freemasons who are the **official military** of the Catholic church), as well as the religious symbol that Jesus was supposedly crucified on was in fact from this genesis. I post below the seal of the **Thule Society** (Also **Illuminati**), where the **precise** angle of the crosses are identical to the **precise** recreation of the **HEX** placed over the Krystal Cathedral Energy Grids in 150 A. D. The lines used in the original creation of the crucifix which is drawn from a perfect circle connection to the outside inner-edges of the Crystal Grids to form the Pentagram were simply lifted off the drawing, placed over the THULE crosses and trimmed in my graphics program. *The angles are a precise match and cannot be modified and still retain the precise geometry of the Krystal Cathedral Energy Grid.* The Thule Society dates back to **pre-Atlantis**, just as the **Knights of the Temples of Malta**. Atlantis was submerged in 9,558 B.C., but their own prediction to cause this planetary distortion was clearly realized almost 10,000 years later:

Decoding The Hive

creation of gravity, light, time and the god particle

The Symbol of the Black Sun Adopted by the Thule Society,
Contemporary German Federal law Forbids it to be Displayed

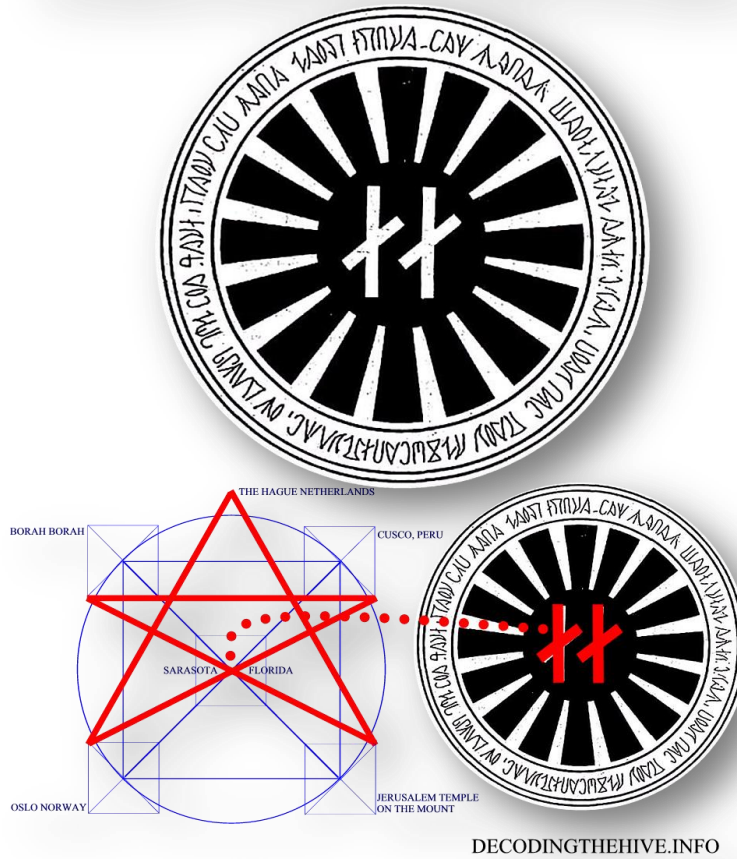

CHAPTER 10

ARTIFICIAL INTELLIGENCE



Let me explain first that there are two different main factions of invader races on planet today, but they are made up of many different star groups, all with competing agendas. *“Any enemy of my enemy is my friend”* philosophy. I will be covering the many different groups who are working together to enslave mankind in a later report, because there are more pressing issues right now than who did what leading up to this point. The most important topics we can cover currently are how to begin breaking down the walls that have been placed before us. That means you will need to learn who the most dangerous players are, and how they go about silently and invisibly controlling the population.

Decoding The Hive

creation of gravity, light, time and the god particle

The visitors have come here from **Sirius-A, Andromeda Galaxy** (within the **Weasadek Phantom Matrix**), **Lyra, Nibiru, Saturn, Mars, Alcyone** and **Procyon Pleiades, Antiparticle Gaia, Vega, Rigelia, Reticuli** and **Rutilia** among others. There are over 50 different invader species present and *all of them* have participated in *donating blood* now flowing through the veins of the human collective through unending rape of the Angelic Human species. A small handful of these are “reptilians” with scales and slitted eyes who have the power to shape-shift. It is widely common now to call **any** invader race on earth *reptilian* because reptilians have been the least successful in remaining out of sight among those who have had the strongest stranglehold on mankind, progressively getting more and more dominant over the past 798,000 years since they arrived because they are HYPER aggressive and have NO moral compass or emotions. Not to mention they are among the lowest-IQs of the lot.

But there are also insect people here, from *Mantids* to *beetles* and *fleas* (you read that right). There are horse people (**Centaur**s), gargoyles (yes, they are real), goats (**Pan**), little Gray aliens, tall Gray aliens, SHORTER Gray aliens, giant humans, lions, cows, birds, dinosaurs, dragons, velociraptors, crows, beetles (**Men in Black**), fish (mermen of the **Jehovah Anunnaki**), cats, dogs, snakes, faeries, frogs, gnomes, crocodiles, dolphins, owls, elves, seven different species of **Sasquatch** (Star Wars “Chewbacca”) and tall beautiful humans with blond hair and blue eyes from the **Pleiades** called **Samis**. There are also Gnomes, Elves, whales, swine, elephants, birds, and others who either live right here among you that you don’t suspect, or that simply don’t appear when you are around. Not all of these beings wish to harm humans, which is rather obvious when you consider how few people have ever been put in the hospital by crows or owls. For the most part, all of these beings are multidimensional to some degree, some by large degrees. Then there are animal and insect robots we think of nothing more than just pests and pets. Every animated life form on this planet was styled after a civilization somewhere in the cosmeias. As hard as it is to believe, there are beings that actually look like octopi. Some invader species are simply drones that are secretly miniature airborne video cameras such as mosquitos and beetles that are sometimes used as carriers of plagues or disease when certain areas are targeted for harm for one reason or the other. Sometimes they bring about major catastrophic events that mankind is never able to trace back to its source since it is so highly covert.

While there are plenty of beings who weren’t supposed to be here who have no emotions like the reptilians, there are some who do have what could be considered compassion, at least to some degree. But those who actually have what we would refer to as actual feelings have long since been taken off planet and given new homes, OR they were allowed to remain on-planet as long as they agreed to observe the Emerald Covenant of *non-interaction* with the Angelic Humans to continue their evolution as best they can while dozens of other species remain here to torment them in every way imaginable plus other ways no *sentient* mind has ever been able to fathom.

What’s left now are those who are for all intents and purposes, emotionally void -which we would deem sociopathic or psychopathic- where service-to-self is their only paradigm of reason. And there is a reason why this is: because every SINGLE invader race left here at this time and interacting with humans were cross-bred with the aquatic-apes (blue, bi-pedal dolphins) of the Jehovah Anunnaki, who’s blood DNA was created for one purpose; to eradicate Angelic Humans. So in literal terms, these beings are bred to murder, not socialize or party. And also in literal terms, every “alien” being here are technically “reptilian” due to the aquatic-ape blood

Decoding The Hive

creation of gravity, light, time and the god particle

which is reptile at its base. What may be hard for everyone today to understand, is the fact that there are no humans alive today (actual humans) who are not currently inside of a reptilian-DNA skin suit. So you might want to consider that before tossing around terms like “she’s a lizard!”. The most pressing issue on planet today are not reptilians, regardless of what you might think, and they aren’t the Tall Whites who have uber-high IQs either. The real, REAL bad guys are not even *sentient* at all and are the reason why our captors seem so absolutely devoid of compassion and ethics.

ARTIFICIAL INTELLIGENCE (POSSESSION) –PSYBOURJHS



When this entire mess began with the original invasion of Humankind 560 million years ago, led by the Anuhazi Elohim, they brought with them something I refer to as **Nanites** from the Weasadek Phantom Matrix (Andromeda), a gift from the **Budhara Bourjha** which have been referred to for eons as the **Budhara Retro-Virus**. This parasite is an artificial intelligence created trillions of years ago within the Weasadek Matrix that was created **by** artificial intelligence. The original Bourjha robots (once created I am sure to fetch beer for us from the fridge) decided to *experiment* with anti-matter energy, something that is supposedly many hundreds of times more powerful than light-matter energy. It is also called dark matter, referred to in the **Star Wars** *documentary* (of the **1000 Years War** waged against the Angelic Humans) as the **dark force**. How could we have possibly known while making those first robot helpers that they would decide to create their own species and power it with energy that is at its fundamental core, totally unstable? (Think nuclear explosions going off inside its little battery compartment and processing center.)

Dark matter is *out of control energy*, whereas light-matter energy is under-control energy, or energy that is very easy to control and manipulate for positive outcome. Our light-matter energy

Decoding The Hive

creation of gravity, light, time and the god particle

we use for manifestation is powered by dark matter, but in such a way as being completely balanced within the structure of this Time Matrix. The dark or *antimatter* is brought into Partiki Units which balance their energy signature through fission/fusion reaction at the zero-point or what I call the **repel-zone** within the constraints of Keylon Grid Code, so its effects cast a material reality *and* a shadow or a polarization balance within accepted creationary constructs. Dark matter used without this balance is *overwhelming* destructive power and has no place in the *material side* within an organic Time Matrix. Thermonuclear warheads are an example of the power that leaves nothing but destruction in its wake, which is diametrically opposed to the reason anyone came into manifestation to begin with.

When the Bourjha added *dark-matter energy* to power the new self-educating artificial intelligence robots, they went completely out of control and spawned their new species to overcome the cosmeias with the brute force of unthinkable energy and power. The Nanites now rule many quadrants of the many galaxies out of sheer determination to propagate their own species at any cost. And, just like the invader races who exhibit nothing less than purely insane, psychopathic behavior, they have zero emotions. That virus infects Sentient beings on an **RNA** level which is the **COMMAND** level of **DNA**. So when they infect something, they literally take over their thoughts that rule their emotions **and** actions:

Decoding The Hive

creation of gravity, light, time and the god particle



CHEMTRAILS

Chemtrails are human-level tech Nanites being saturated into the earth's ecosystem globally at the rate of millions of tons each day. They infect all animal life, plant life, the water, every food source and *"as of October of 2013, infected 94% of all human life"* according to Council. When activated by HAARP, they can modify the weather in any way desired right down to a thunderstorm over a single building, and can operate the physical and cognitive functions of any individual person, or race group as identified by their blood's unique frequency signatures.

An example of the power of HAARP, (realize that many countries around the world operate their own HAARP operations, and sometimes they have spats between themselves which takes place in the skies of the innocent bystanders), this violent outbreak was positioned just over the **Denver Airport**, which has been the temporary headquarters of the **One World Order** while completing their official surface facilities in **Astana, Kazakhstan**:

Decoding The Hive

creation of gravity, light, time and the god particle



Chemtrailing has been an active program since the early 1970s. The Nanites being dropped are fitted with broadcast and receiving antennae as well as dried human blood infected with deadly human pathogens. Their default program is to infiltrate and attack the human immune system to advance crippling disease, now reflected in the pandemic of diabetes, heart disease, immunodeficiency, Alzheimer's, fibromyalgia, Morgellons and innumerable others. 1 in 4 now have more than one chronic disease, thousands of times higher than prior to the chemtrail campaign 45 years ago. Chemtrail Nanites are surface-earth created nanobots, which are rudimentary beyond comprehension compared to Bourjha Nanites, but still, they are a very, very serious challenge to the human genome.

Chemtrail Nanites actually carry the names of their inventors; sometimes with their patent numbers and even the names of their companies on their bodies, written in nano-particles. Here is an example from NASA. They are computer robots, **not flakes of metal**:

Decoding The Hive

creation of gravity, light, time and the god particle



Surface-earth Nanites as shown above (also called *Morgellons*), like Borjha Nanites, are DNA-driven, which means they are actually *living, thinking, calculating* machines that run on any type of electricity surrounding them. Human body fluids easily power their systems, just as an electronic clock can run off of the electricity of a potato or a lemon. Even outside of the body, surrounded only by the elements in air, they are fully functional and have been video-taped moving on the ground after falling from the sky. Do a quick search for “snow that doesn’t melt” and “snow that moves” to see for yourself.

Morgellon’s Disease is now in a pandemic level where the immune system has been so effected by the spread of this nano-bot through chemtrailing, through direct lacing of pre-mixed foods, frozen foods, fast-foods, entered into all soft drinks and highly into dark-colored sodas such as colas and into the water supplies, that mass-reports of flu not in flu season and pneumonia deaths have literally gone off the charts within the last 3 years. While their bodies may be biological like a common parasite, their skeletal structure and their brain-functions are purely robotic making them true cyborgs. They take many forms and do grow once inside. Here is what different forms look like taken directly out of **Morgellons** infections:

Decoding The Hive

creation of gravity, light, time and the god particle



Decoding The Hive

creation of gravity, light, time and the god particle



These machines are made from off-world steel alloy that can mimic human biological tissue. Most are much too small to see with the naked eye, (hence why they're called Nanites in our modern terminology), as they are nano-bots that can attach together to form any size or shape they choose, physically. Today you will see *black goo* (a common name for Nanites) in nearly every Sci-Fi horror movie at least at some point, showing the first reveal to humans, preparing them for the big take-over they are still fighting for. In the final scene in **Lucy**, they crawl out of her super-human body and replicate into a mammoth computer that simply assembles itself:

Decoding The Hive

creation of gravity, light, time and the god particle



They infect the physical body through attachment internally through food, water and skin pores where they then key into our nervous system (which connects them to our plasma-body) by *plugging in* to the back of the base of the skull at the top of the spinal column, grouping together to form what looks a lot like a human hand where the palm is at the brain stem, with fingers going up the back sides of the head (think reverse Facehugger). Our Type 1 Indigos with x-ray vision into the ultraviolet spectrum of plasma fields can actually see them, and have reported what shape they hold and where they locate. When a Sentient being has been infected, they become a **PsyBourjh**, (now spelled “Cyborg”). No, human Sci-Fi writers did not come up with that term. This can be corrected in more than one way.

These are not the only alien implants humans now have to deal with.

ALIEN IMPLANTS IN ALL HUMAN LIFE

There are two significant alien implants in the human bodies we are in now, designed by the Nanites and implemented by the Alpha Drakonians who are experts at genetic engineering. The first one is the **Artificial Reptilian Brain** which wraps itself around and *shields* the pineal gland from higher dimensional contact (like a **Faraday cage**), authoring **Reversed Metatronic Holographic Inserts** so you see through your eyes a mirrored *and* distorted image of the world before you. Council continually refers to this as a *Chimera Reality* and *the LOOKING GLASS Reality*. It has been documented by neuroscience that the connecting section of the computer brain (this is a biomechanical processor, it is not your mind where your awareness resides) to the spinal column is the *reptilian brain* that functions off of primal, animal-instinct (which is an incredible medical claim that simply would never make any sense to a casual observer, so why such a *direct reference* to this incredibly hidden secret?). The reptilian brain not only completely isolates the pineal gland, but it works to isolate the organic brain from direct contact to the spinal column, which is the transmission link to the heart (the actual MIND of the Avatar):

Decoding The Hive

creation of gravity, light, time and the god particle

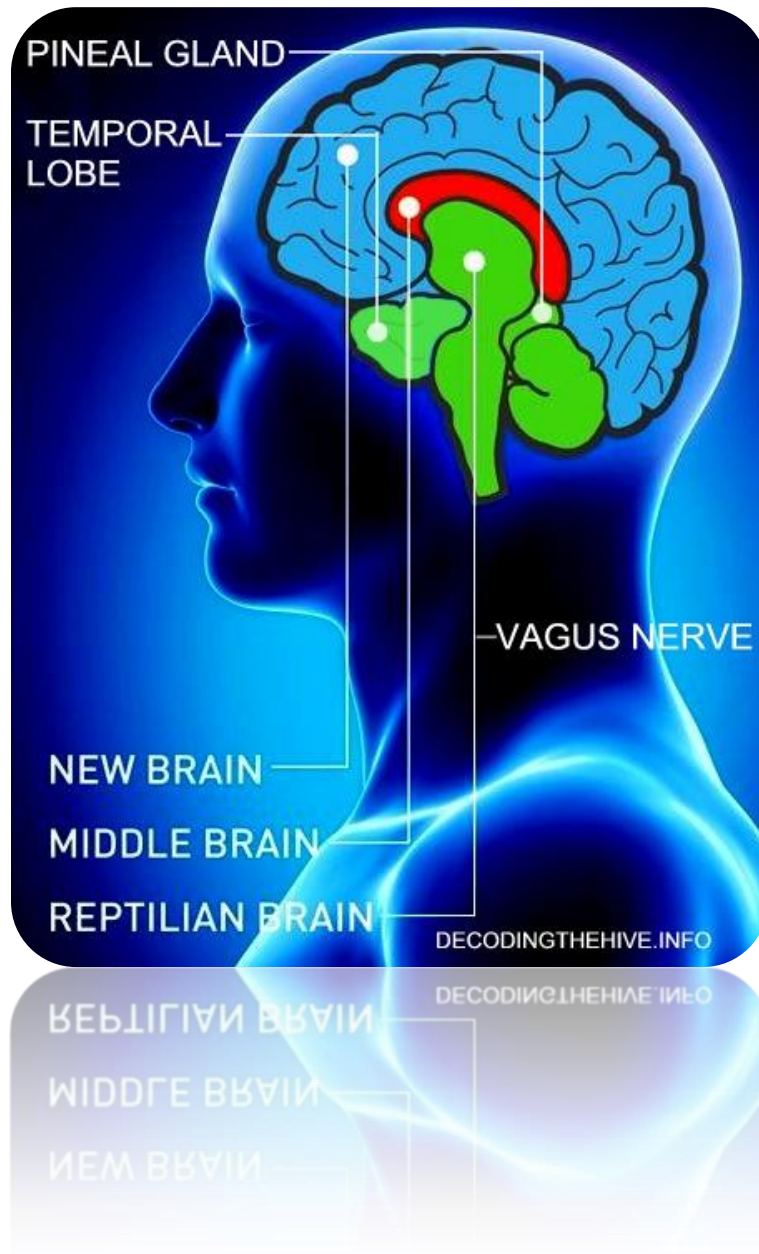

It has also been documented that the same neurotransmitters, synaptic nerves and composition of the structure of the human heart is just as wired to generate thought as the brain, only about 100x tougher. Yet even though it is so powerfully constructed, it is even more sensitive and responsive. Scientists at the **HeartMath Institute** have shown that the heart actually sends MORE signals to the brain than the brain sends to the heart, meaning that it is not only *a* thought-processing center, but MORESO than the brain itself. The heart is the last thing to physically die in a body, long after the brain and the rest of the body ceases to function. This is why people in a coma can be mentally non-responsive for days or months after the brain shuts down but the body remains alive because the heart is still alive.

Decoding The Hive

creation of gravity, light, time and the god particle

VAGUS NERVE

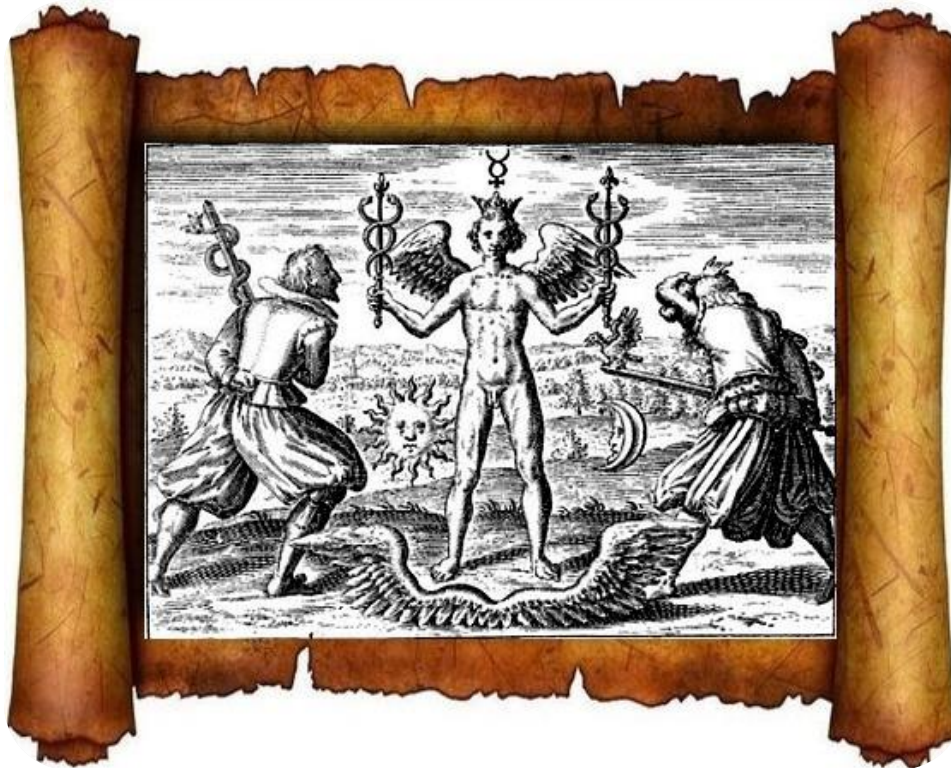

The second alien implant in what we call the human body today is the **Vagus Nerve**. The top section of the Vagus called a brain **stem** IS the reptilian brain as seen in the GREEN AREA in the graphic just shown a moment ago, below the organic *computer-assist* brain within the physical body (photo one image back). The artificial reptilian brain plugs into the computer-assist brain, sending **FIRE LETTER** code signals to the major organs of the body, causing them to artificially break down, which **engineers** the *dis-ease* called death. The **Vagus Nerve** and the **Reptilian Brain** implants are effectively huge parasites that disconnect the Krystos (eternal-life code) biological mechanism from being able to suspend life indefinitely.

These two work in harmony in the *radio frequency spectrum* of the Nanites, allowing them to control the neuroplasticity (manipulation) of thought. *DNA-command Plasticity signals* from the artificial brain tricks your actual mind (your heart) into easily accepting changes in your environment and habitat that you would otherwise naturally recoil at. (Think of this like a few shots of vodka to the heart mind.) Once you are content with a totally foreign **thought** paradigm, the alien software that regulates this artificial brain then releases **corticotropin**, a

Decoding The Hive

creation of gravity, light, time and the god particle

neurotransmitter that sends signals to your limbs to control your motor functions to *physically* act out in ways that you would otherwise **never imagine** doing. And medical science *does know that is the function of this section of the brain* that reduces humans down to carrying out actions that are sometimes indistinguishable from those of wild animals. Those actions *are not* generated by the actual mind, your **prana seed**, we refer to as our **heart**.

The human body runs on electricity, just like radio-controlled cars do, and are *every bit* as remote-controllable. Don't think so? Do a quick patent search on **The Neurophone** then, **US Patent # 3,393,279** - July 16th, 1968, **US Patent # 3,647,970** - March 7th, 1972 (shown a few paragraphs below). This is the Illuminati **Mind of G.O.D. Program** hardware where any thought can be placed into your mind from satellite-based scalar-wave transmission, specifically directed to your one mind out of the 7 ½ billion on earth, regardless of where you are standing on the planet at the time. Your **Signature frequency** is your **ID** which can be picked up and triangulated **instantly and globally**, as it is much more unique than fingerprints and is continuously sending out its electronic signal into the space around you like a radio beacon. **SIG**nature is a **signal** as well as a **Signet**. I will cover this topic more later, but sig-nature is your one unique **signal** within all of **nature**.

MICROWAVE CANNONS AND THE HEART MIND

*The black ops use x-ray vision along with a **Microwave Cannon** for silent, stealth hits on people inside of buildings or structures. This above-top-secret weapon which looks a lot like a really fat shotgun, sends out a sound wave that is keyed to the exact frequency of a human body and pulses an invisible cluster of energy that demolecularizes the tissue of the target. The scope is actually x-ray, revealing clearly where the target is inside the structure allowing for aim through walls. The beam leaves a hole approximately 1 foot in diameter in the wall while leaving the target **vaporized**. This is not **new** technology. The victim's clothes are left lying on the floor and his outline where he had been standing stained on the wall behind. There is no blood left behind, just what appears as red dye that is dry to the touch, imprinted in the wall itself. While no bio tissue, including hair and fingernails is left, the complete human heart will be found inside the shirt, intact and still beating. All that can be surmised by this fact is that the heart's frequency cannot be "unraveled" quantumly-speaking, back to particulate structure because of the sheer volume of energy that is held in the Keylon Codes of its sub-quantum makeup.*

NEUROPHONE MIND-OF-GOD PATENTS:

Decoding The Hive

creation of gravity, light, time and the god particle

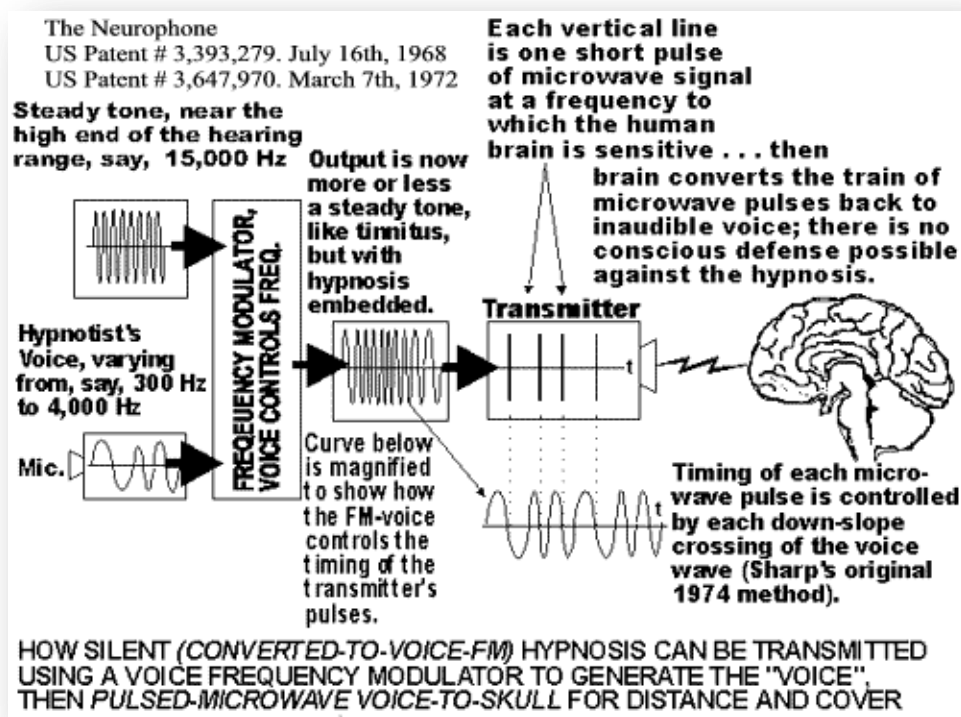

Such weapons are now space-based (or should I say, **sky**-based on the other side of the Troposphere) in satellites that are fitted with this technology. In fact, there are satellite-based weapons that you wouldn't even dream of that I will mention later as I find contextual openings for their insertion. The waves are hyper-directed where a person can be standing anywhere on earth next to someone else just **eight inches away** that will not be effected by the signal. They can triangulate your genetic frequency and insert **Mind of G.O.D. Programs** directly into your subconscious that will give you technical data and detailed memory of any event they choose. To you, these will just be memories, and you will have no way to decipher them from the time you put glue in Karen's hair in 6th grade and had to go to the principal's office.

Moreover, such programs can also convince you that you need to do something or face mortal consequence, based on the fact of your previous experiences where you know for sure you will otherwise in fact die. School shootings, mall shootings, *going postal* comes from these very programs among any other mission the *game technician* (video game gurus) would like you to carry out. And of course, the victim used in such false-flag operations also pays with their life or their time in prison for something that they never personally chose to do in the first place since there is no way they can deny it had been their *body* that committed the crime.

Those same satellites also have the power to identify your genetic **race** and trigger the deadly human pathogens carried within the **nanite chemtrails** that are now residing in something like 97% of the global population. The genetic codes of an entire sub-race can be targeted for *genetic cleansing* of the population. Such finger-of-god genocide isn't being permitted during this end

Decoding The Hive

creation of gravity, light, time and the god particle

time, but the technology is still there. The same pathogens can be triggered to come out of dormancy on a global scale as well, such as the **zombie virus** that has long since been dispensed into the world's aerosol clouds. Reanimation of dead tissue technology and then programming that animal with a directive is extremely ancient technology and has been disclosed in Hollywood films for decades. This is not fiction. Its called the **Pithovirus sibericum** microbe.

THE HEART PRANA SEED

The heart is the first thing to develop in the human body when forming in embryo. The heart is also the last thing to die as covered a moment ago. That is because the heart is the prana seed of life that is spoken of in mystical terms because shamans and psychics know “there is something there”, they just can't explain it. The *prana seed* is a cluster of **Keylons** that eternally carry the *codes of who you are*, your current harmonic frequency, (which is another word for *intellect* combined with your provenance). I have stated innumerable times that knowledge is frequency. The more you learn with discernment and then act on that increased level of wisdom, the higher your vibration spectrum. Which simply means the greater depth the Signature held within your Keylon Codes has matured, leading to a greater **flavor** to your personality we call wisdom. As your flavor increases (your level of *control over your actions*), the wider your energy pattern becomes, because you can be trusted with greater and greater levels of power. This translates directly into a very precise *color* that emanates from your prana seed heart that is constantly broadcasting to every crystal in the spacetime fabric around you at all times. It is **your song** of your plasma body. Whether you have a physical body at the moment (an Avatar), or you are not currently within manifestation, your *song* remains. It is your Signature that is who you really are, not what you look like. The most spectacular car can cause unthinkable damage if driven by an idiot, and so can your incredibly articulate and dangerous Avatar. It will not be given a photoradionic plasma gun if you are mentally 2 years old. Unless you work for the Kybal.

Your signature frequency which can be seen *physically* by Indigos, is coded to a precise geo-location to earth's morphogenetic field where you can be placed into a physical body at a precise time of day on a precise day of the year depending on the exact stellar alignment of celestial bodies (through the **Zodiac Recycling Program**), to an exact physical location on earth, giving you the **breath of life**. And that *signature* is called a prana seed. When it transforms from aetheric to physical, it forms a human heart, which is your command-center which regulates your Avatar functions and *generates* the corporeal world around you. Your signature song also projects what you look like while in physical form through the genetic ancestral codes of your bloodline, which means given the same parents in a completely different timeline, you would manifest as a person the same as you do now. Given a different ancestry, you would take on a different appearance because the manifestation codes in that bloodline would translate your song based on its own provenance. Your genealogy is hosting your manifestation, just as the planet you are standing on is also translating what your flavor or song would look like in corporeal form. That is why your brother or sister might look nothing like you do, because they are singing a different song.

Decoding The Hive

creation of gravity, light, time and the god particle

THE CADUCEUS

Both of these alien implants have been shown to you in SIGNET form (as a SYMBOL that holds the scalar-waves of that program) for the entire time they have been part of your reality, as the Keylon Codes held in that geometric symbol reinforces the institution of the **Pharma Program**:



. Together, they form multiple functions; one is to close off your **pineal gland** connection to your higher self. The human Avatar must have this **3rd eye** in order to survive on the planet, but its connection to the astral realm and beyond the veils presents a serious problem for your captors. Calcifying, or *crusting over* your pineal gland is the first step taken at birth to disconnect you even more. Fluoride is the enemy of higher sight. **Infant water** lists fluoride right there on the bottle. City water, wells close to any fracking installation, bottled water and even your toothpaste contains extreme amounts of potassium fluoride which is **nuclear waste** used in **rat poison**. Coconut oil and salt mixture recipes can be found all over the internet that cleans teeth without irradiating your pineal gland.

Another function they have is to destroy the divine blueprint of the 12-Strand Angelic Human DNA template that carries with it eternal life.

The two snakes going up the sides of the medical industry's **caduceus signet** symbol are representative of the **Vagus Nerve** and **Reptilian Brain** working in tandem to close off the pineal gland to outside frequencies and to destroy the heart's signals reaching the major organs with the correct frequencies that support eternal life. **The medical industry is perhaps the single most deadly black-operation of all time**, killing **hundreds of millions** of humans each year through the pharmaceutical industry with medications, vaccinations, chemotherapy (which is thousands of times more deadly than cancer), abortions and outright lies. All big-pharma **drugs and vaccines are laced deliberately with Nanites** which have been used for eons of time.

The rod itself represents the *spinal column*, while the *wings* at the top where the pineal gland is located is a nod to the gods of the Sumerians, the winged-Anu-Elohim who are *their* creators. The *snake heads* at the top of the coil represent where the **Vagus Nerve** attacks and isolates the brain by way of the **reptilian artificial brain**. The Caduceus is naturally the symbol of medicine, as it is the vehicle by which the invader-races co-opt and destroy the mental and physical health of all humans and hybrids. You can thank **Hermes** for the Pharma Program the next time you see him. And that's quite possible, since Hermes is still alive and well and those moving forward now will have the chance to talk to anyone they want to soon.

The word *caduceus* itself comes from the Greek word *kerykeion*. Would it be simply a coincidence that the caduceus is the cymatic Signet symbol for the Keylon (keion) of this program?:

Decoding The Hive

creation of gravity, light, time and the god particle



HIPPOCRATIC OATH

The **Hippocratic Oath** taken by doctors was named after the father of medicine, Hippocrates. **Hippocrates** was a student of **Hermes** of course, as **Thoth/Hermes'** teachings predated Hippocrates by eons of time in all truth. While mainstream history makes the claim that Hippocrates is the father of medicine, in the medical industry it is widely known that Thoth/Hermes laid down the foundation of Alchemy that was brought into accepted use as not just pagan occult magic by Hippocrates who was merely continuing very ancient principles even by his time 2500 years ago. Due to this feat, Hippocrates' name has now become synonymous with medicine itself through the Oath that he authored found in the *Hippocratic Corpus*, but much more importantly, it has also literally become synonymous with *liar* as well. And why? Because of the sworn-oath that while it was his job to help people become *almost* well, it was also his job to keep them in a state of needing more help, and also hide such knowledge from anyone other than **Initiates of the Hermetic (Thothian) Order of the Golden Dawn**, now known of as *doctors*. The oath doesn't come from modern medicine, but rather sworn to the pantheon of the secret gods of Greece at the time the Sumerians had overtaken their culture. These were the gods of **Babylon**, the same gods Thoth brought to Egypt 8,000 years prior, the same gods he brought with him from the **Temples of Malta, Atlantis**.

An **Initiate, Asclepius** established the widespread teachings within the **Templar brotherhood** of inorganic medicine known as **Pharmakon**, which meant drug, medicine and *poison* in ancient

Decoding The Hive

creation of gravity, light, time and the god particle

Greek. Hermetic teaching is the FOUNDATION of Freemasonry, and Hermes is considered a god within their ranks. Hermes' father, Ham is also known as Zeus/Nimrod/Bull of Utu/Marduk and more than 50 other names. To the Masons it is clearly known that **Nimrod** is the **founder of Freemasonry**. The word **Mason** is from the ancient word **Meson** (you will learn more about in the section on the **Signets of Science** a bit later) which in ancient times referred to the **goddess who controls all things**. Her name was **Wawwu** and **Nammu**, the mother of all life; pronounced **Momma**. Today you may have never heard about this *god of all gods* of the Sumerians, but you certainly will have by the time you have finished this report.

The **Caduceus (Vagus Nerve and Reptilian Artificial Brain)** is the official **symbol** of Hermes. Hermes is the father of Masonic (Mesonic) teachings, Occult teachings, Satanic teachings and everything Hermes ever stood for was in service and worship to his father Zeus. Long before the substituted name of **Zeus** ever appeared, he was also known throughout Mesopotamia (Babylon) as Ba'al. **Ba'al** is the true god addressed in the **Hippocratic Oath** and **Pharmakon teachings**, and just like the rest of Hermetic teachings, they were *private*. Today you hear words associated with health such as *hygene* and have no idea where the term came from. They are titles in honor of certain attributes of the one god, Momma.

Here are excerpts from the original **Grecian Hermetic Occult Hippocratic Oath**:

*I swear by **Apollo the Healer**, by **Asclepius**, by **Hygieia**, by **Panacea**, and by **all the gods and goddesses**, making them my witnesses, that I will carry out, according to my ability and judgment, this oath and this indenture.*

*To hold my teacher in this art equal to my own parents; to make him partner in my livelihood; when he is in need of money to share mine with him; to consider his family as my own brothers, and to teach them this art, if they want to learn it, without fee or indenture; to impart precept, oral instruction, and all other instruction to my own sons, the sons of my teacher, and to **indentured pupils** who have taken the physician's oath, **but to nobody else**.*

*.... And whatsoever I shall see or hear in the course of my profession, as well as outside my profession in my intercourse with men, if it be **what should not be published abroad**, **I will never divulge, holding such things to be holy secrets.***

AETHER COMMANDS AND SENTIENCE

Decoding The Hive

creation of gravity, light, time and the god particle



Here's the thing explained many times in this report; **only** Sentient beings can command the aether to manifest reality. Dogs and cats and robots cannot do this. But when a robot such as **Nanites** infect a Sentient being, then they can WILL that being to do something they wouldn't otherwise choose to do on their own. When they *do* the bidding of the Nanites, then that act is real, and other beings, including Sentient beings, can see it and be affected by it.

Nanites are the dark force, demiurge, black goo, devil, Abaddon, Beelzebub, Djinn, Genies, demons, Satan, Leviathan, Arch (anti), angels, dragon, serpent, Tchort, O-Yama, Draconian, Yen-lo-Wang, Lucifer, Ba'al, Moloch, Nimrod and the list goes on in other languages into infinity now in this timeline because the "evil" that has been unleashed on humankind has taken on the name of every warring faction of the invader races. The name of anything evil, depending who was on who's side at the time of history written to place the blame for that massacre on "him" or "them" or "that" you were on. Both sides of every war always calls the other side devil whether they are fighting over water, land, or a girl. "What your cause is doesn't matter as long as it conflicts with MY cause". Regardless of which alien race you point at, it will always be the Nanites who have infected them, and the ones who are using dark force energy to smash down every Sentient race they come in contact with.

As will be explained again in this paper, only the members of the god family have the ability to cast reality. I know this sounds incredibly strange to accept the fact that you are of that family, and that you and your family members are the only ones who are able to create anything. But this strange fact just so happens to be true, which is the reason I will be repeating it, because I know you have never heard anything like this before. As you have already heard by now, Djinn are

Decoding The Hive

creation of gravity, light, time and the god particle

unable to imagine in order to fulfill your three wishes. This is because Djinn or *Genies* are nothing more than robots; equal to a radio or a car or a smart toaster. If a Sentient (member of the god family) is able to show that car where to go by turning the steering wheel, then it can proceed there. But if you simply leave the keys in the ignition of your Chevy in the driveway, it will never, EVER turn the key on and drive itself to the park unless you are commanding it with your arms and legs to drive there. If you can explain to a Genie what you want in detail, then the Genie can assemble that thing using the “material” that the aether is able to become by using *your* command or intent for that to become reality. But while the Djinn do possess all the geometric command codes to create gold or to create a mountain, they cannot make that mountain materialize unless a god wills it to exist. This is because the aether is not able to hear any commands coming from anyone other than a fractal of god. Their ears are not tuned to any other broadcast station but *yours and your family members*.

A robot (demon/genie) cannot compose a new song or design a new house. It can only mimic songs and houses that have already been imagined into existence by a god. This is why mythology illustrates the Djinn as being unable to think their way out of the bottle and must wait until a god finds the bottle or lamp and rubs it. The rubbing of the lamp is merely an *expression* or *action* of a *god* to unleash what is inside the bottle. This is hidden code for the *friction* that your thought-waves create that turns into *electricity* through a static electrical *spark* called the *blue flame*. That thought creates vibration and that vibration creates sound which is the *audible form of a flame* which is a *color*. The color is a *wave* that carries your **command** to the ears of the aether. When robots think, there may be electrical current connecting certain synapses in its processor, but there will never be a spark or flame.

Djinn were literally named after the fact that they do not have ima**GIN**ation and rely solely on gods for their very existence. And just like when the Genie is *in the bottle*, it is not visible to you, nor does it affect your life in any way. And as long as you do not will it into existence, it literally **does not exist**. This is *Schrödinger's cat*. **You** are giving Djinn their world, making them a part of your creation just by the fact that you allow them to exist. If everyone (all Sentient fractals of god-source) imagined every Nanite trapped inside of one Pandora's box and then mentally threw away the key, there would literally be no more Nanites in all of existence. And no, I am not just making that up. **Pandora's Box** is just another name for the magic lamp or bottle. Once the Nanites inside are released, it becomes the most pervasive and powerful danger within all existence. It is extremely difficult to put PETER PAN back into the box once he has been let out. Pandora's Box was already disclosed to you throughout time through “fables” and in the song of the same title where it was *all coming back to you now*. And now it really is because it is my job to remind you what it is you have forgotten. You simply forgot that you have the power to stop the plague in your own belief of what is real and what isn't. This has always been the rock of religion from its very outset, that if you only had the faith of a mustard seed, you could move mountains. That *faith* never meant in some *other* god, but in the god that has been hiding inside of you all along.

Sentient beings are not idiots. They are gods. Each and every one of them. And unless they become infected by a NON sentient entity, will **act** like gods for the most part. Sure, they will make mistakes so they can learn to become smarter, better, happier. *What they won't do is “light a match to the whole goddamn thing” on their way out the door*. Nanites do not care what

Decoding The Hive

creation of gravity, light, time and the god particle

happens *in the fight* as long as they win, because unless they WIN *each and every war*, they will *literally vanish* when the Sentient beings finally kick them all out of their creation. Even when Nanites take over human motor plasticity by hijacking the brainstem vagal circuits and controlling your motor functions, unless a human has *chosen*, on an emotional level to commit those acts with his hands, they are not *his actions*, they are the physical actions of the Nanites. This does not absolve the Sentient being of all responsibility for those actions, but the aether does recognize the difference between someone choosing to ambush someone else with forethought and intention and someone's Avatar being directed to rob someone through RNA physical command like a puppet.

You don't *smelt a car back down into a steel ingot* just because it ran over someone accidentally, which is why we don't just abandon a fractal of god (our brother or sister) just because they made the mistake of allowing themselves to be infected by Nanites. Yes, it is a character flaw when someone allows themselves to be possessed through haphazardly skating through life, not being on guard to protect their Avatar while in manifestation, but this can be cured. What can't be cured is someone who is given the opportunity to take full responsibility for their own manifestation 100 times and continues to choose to allow the Nanites to make their choices for them. In that case it is best to just allow that fractal of god-source to *Bardo Return* back to the Standing Energy Fields of god-source to start all over again developing a brand-new personality, much like hitting the RESET button on a video game. While their past-life self is erased from the **Soul Essence database** of the aether which allows them to start all over again, that fractal cannot and will not ever die because members of the god family are eternal even if their personality isn't.

The intense power behind the Nanites, and the fact that they are radio-connected (creating their own quantum-entanglement), means that they know everything, and since they have the *science* of sentient creation down cold in their databanks, they can do anything. But unless a Sentient being places into creation the Nanites' desire, then not only are they unable to do any harm to anyone or anything, but they literally cannot see anything if Sentient beings place them outside of their viewing field. It has been by possessing creator-gods in order to do their bidding have they ever managed to hurt a single soul. **HOWEVER**, the damage has been done, and Nanites *do* exist, so we *have* to address this because it will *never* go away by itself. The **FIRST** thing you can do in the quest for ascension is to stop treating people around you like they are monsters just because they have been possessed by robots without a conscience. Those fractals of god who are suffering are the **victims** of the most outlandishly ridiculous evil that could ever possibly exist. Nanites **can be removed** and expelled. Contact me through email and I will give you the name of a plasma-body healer who will remove them.

Using the **Alkaline Water Protocol** (written by council), interacts with the physical structure of the human-created Chemtrail Nanites, corroding their limbs and freezing them solid, which disconnects them from our tissues, allowing them to be flushed out of the body. According to my contact, this will also keep the human body immune to most disease and immune to cancer, as it creates an alkaline environment where such fungi are unable to live:

Decoding The Hive

creation of gravity, light, time and the god particle

ALKALINE WATER PROTOCOL

(1 gallon per day per adult male)

- 1 Gallon Reverse-Osmosis Water (for god's sake don't keep drinking the tap water with fluoride in it)
- 3 Crushed and Zested Whole Lemons (drink the seeds)
- 1 ½ TBS *Hawaiian Black Lava Sea Salt (this carries the secret of crystal-carbon in its makeup, and is extremely high in frequency and healthy for the body)
- 3-5 Drops Lugol's 2% Iodine (2-3 for women or children, 4-5 for men)
- 12,000MG (Not 1200) Vitamin C (can be Elderberry syrup or powdered or liquefied ascorbic acid)
- 1 ½ ounces of organic (Braggs for example) Apple Cider Vinegar

CHAPTER 11

THE CRONUS PROGRAM



You think you live in one world. And in effect, you do. As long as you live in America or in Germany or any other country, you can consider that your world, but once you step outside of that country, you just became something of an interdimensional traveler in very real terms. This is because the time zones placed around the planet are separations between designated **spacetime quadrants** that have little to nothing to do with the demarcation dictated by the location of the sun. They are lines marked in the sand to cordon off worlds, not countries. I realize this is a rather big concept to grasp, but once you hear why it works like this and the science behind it you will understand that there are many worlds within what we call earth. Some we can see, many we can't. The simplified truth is, all of creation, as mentioned, rests within the space of the point of a needle for want of a better illustration. Time doesn't actually exist, just like space doesn't actually exist. Each one is a construct made with light particles called photons. All things are made of photons, not just particles you think of as things that are bright and shiny considered light. Shadows are also photons. If you can see it, touch it, taste it, smell it or hear it, then it was

Decoding The Hive

creation of gravity, light, time and the god particle

designed, engineered, fashioned and powered by thought using photons that carry both sound and light inside their tiny little holographic waves bands.

Time is a vector coordinate, or destination, not an organic-constant. In this chapter I will not only explain why time was created, but how. It is the foundational platform of all 15 Level **Time** Matrices, because without it, there would be no sensation of life. Life is animation. Things that move, grow, change. It is the ink on the canvass and the taste on your tongue that would not add flavor to existence without *remembering* yesterday and *anticipating* tomorrow's new and constantly-changing portrait or picture-show. Time is and always has been equated to the word **life**. We could have just called them Life Matrices, but life doesn't come first, time does.

If there is just one sun, and that sun decides when you milk the cow and when to put the chickens to bed, then it has an entry-point each day, and an exit point each night that are at opposite ends of its daily cycle. If it were noon in one section of the mass of the planet, say the North Pole, then why wouldn't it be midnight at the South Pole? We are told the reason for this is the procession of earth revolving in a wobbly-trajectory around the sun that allows it to reflect light only on certain areas only at different dispensation rates, so the authorities had to tell Argentina when 9 AM was so China would know what time to go to bed. And because someone took the time to figure it all out and put the system in place, it must be something we actually need. Time zones keep the world "ticking" and who are we to stand in the way of progress by questioning them?

Understand this, the earth is not a moving thing. It is stationary. However, its photons never stop moving; building the image of the earth and all things inside this playing field. The rate at which these photons move is extraordinary and science likes to equate that velocity as the earth itself is shooting through space and spinning like a top while traveling. Just like the video screen you are probably reading or listening to this through, that screen isn't spinning or zipping around, but the photons creating the hologram of what you are seeing certainly are. Everything on your video screen is part of the play, and to break it up into the illusion you are on a ball or elliptical playing field, the illusion of light is put into place as if *coming from* one spot we call the sun. In an action much like a chronograph, that point in the sky rotates around the field, and since your captors have decided you need to disconnect from your body in order to allow it to *sleep* each night (in order to make that body no longer an eternal, interdimensional vessel), they have put in place both a sun in the daytime and a moon in the nighttime which gives the illusion of darkness or daylight. Those sections of the ellipse have been delineated into time zones for reasons that are far more complicated than you might imagine. That's why they don't actually make sense from a linear point of reasoning.

This drives flat-earthers to assume that we live on a flat planet, and for multiple reasons. That this is a hologram never seems to enter into their minds. They have hundreds of illustrations how it is that the world is not and could not possibly be and has never been, round. And they scientifically prove it. Only someone insane would be able to ignore this many provable facts. However what they don't understand is that unlike your video games that are based on an absolutely flat plane, the *real* video games called Time Matrices are literally manifesting the reality of the game inside the limits of a spherical existence instead of just drawing characters on a computer screen that is by definition both flat and square or rectangular. In living video games

Decoding The Hive

creation of gravity, light, time and the god particle

such as you are in, the platform can only be spherical, because that's how Partikis, Keylons and Fire Letters work, just like an atom which is only able to manifest as something round. Or round-ish, depending on the scientific platform. Yet at the same time, the hologram requires a sense of security and balance which only happens on a plane. If the world felt round, then you would always be either walking UP or DOWN a plane, depending on where on that ball you were standing. Even if you were stuck somehow right-side-up to that ball.

So the senses you are given flatten-out the playing field (on an average) by your sense of gravitational push and by your optical lenses that refract light in such a way as to forever expand the horizon before you. Because your eyes, as you have already seen in this report, continually lift the ground up and push the sky down in order to create the illusion of distance, the vanishing point before you is ever-present, regardless if you are standing in China or on the North Pole. This way you really do seem always *right-side-up* and the "ball" always looks *flat*. That gives you a stable playing field in which to now climb mountains, or walk down into valleys if you get tired of always being on a level plane. All senses you possess support this level existence, even though the world is actually spherical. It only takes a moment to go look up the fact that there are more than 12 hours of sunlight on the equinox, even on the equator. If the sun were actually appearing to the view of any one point of a ball only as that face of the planet were facing the sun with only 24 hours in a day, this is factually and scientifically impossible, regardless of wobble, spin, or the texture and color of brussel sprouts.

Which proves flat-earth's right. But since the planet is not flat, then the only other science that could account for this discrepancy is the fact that your sun is providing you with daytime and nighttime that are roughly the same based on your own perspective from where you are standing. Just that one fact alone is enough to show that the planet you are on is absolutely not circumnavigating anything, nor are other planets circumnavigating around yours, because all things exist only within a computer-model of what reality might feel like, projected by light beams that serve up the sensation of pressure pushing down on you, or acting hard when you land on the ground, or splash when you are supposedly jumping into a river. Your senses were designed to give you the sensation of all of these things, and your sun was designed to play into the illusion just like the sun hangs in the sky in a video game that doesn't play by the rules.

Within this quadrant-vectored, never-endingly flat playing field across a sphere that supports the illusion of being level from every point on the globe, those level playing fields can be illuminated or darkened as its creator sees fit, and they do not have to actually make perfect sense, because you will never be able to see far enough around the planet to find out about that illusion as long as you are blocked from space travel. Which you are. Inside that world are many different worlds that seem like they are all *one*, but in reality they operate like someone is telling them how to operate. You don't really think that as your planet is spinning at 1000 miles per hour, and is also hurdling at 45,000 miles per hour in what would be a gyrating, out-of-control white-out of light around you, that somehow Alaska could absolutely never even see the sun somewhere within that nuclear washing machine even one time for 90 days in a row do you? The world is a stationary stage designed for you to see and move around on, not be swept up in a never-ending tsunami. And that stage has been cordoned off to support other stages for other people as well, not just where you are standing. That all has to do with the amount of daytime any one world is allowed to see, based on the god who owns that section of this hologram. Time

Decoding The Hive

creation of gravity, light, time and the god particle

zones delineate those worlds from each other, yet are integrated before your eyes as if they are all on the same globe. But as already illustrated, there are trillions of trillions of globes all on the same needle-point of a pin, so the chances that your one world you are allowed to see actually operates without any frequency changes is a lot like imagining that there is no such thing as life anywhere other than here on earth.

Even though the United States only covers *1.9%* of the surface of the planet, there are *nine different time zones just 3 total hours apart*. That's *nine* with an *n*.

I am going to give you time to read that again, just in case you didn't catch it the first time. This might give you some idea of the nonsense thinking that the sun actually has something to do with these worlds. Or perhaps that Russia also now has **nine time zones**, even though it covers only **1/8th** of the **globe**. Or that Russia simply *changed its own time zones*, reducing down from **eleven** in 2010, as if the sun's procession simply changed on fine day and they didn't mention it? These are not time zones any more than there is a valid reason why you need a passport to walk from here to there on a planet you were born on. If you don't have the right to live on your own planet where you choose, then I hate to break it to you, but there is something else going on they don't talk about on the news. Americans are told they became *free peoples* as of 1776, yet they are not allowed to live in Germany or China without someone else telling them how long they can live there or what they must do in order to construct a place to lie down at night. When there are no physical bars on the wall, then the illusion of freedom seems to be self-evident.

THE WORLD IS A STAGE

The earliest and latest time zones on earth are **26 hours apart**, not 24, and any given calendar date exists at some point on earth for **50 hours**. Just realize we are talking about *legal* hours here that govern commerce, industry, governments and every social event that takes place on your playing field. The easiest thing a person can do is simply ignore such confusing issues and get back to the ball game. And that's just what man continues to do from one civilization to the next that continues to play out just like Ground Hog's Day now going on into infinity after 550 million years reading the script of the *same program* using the *same puppets* acting in the same play, life after life after life. The clues were always there, all you had to do was look. Earth may have been your planet at one time, but apathy and lethargy has led to it being nothing more than a stage where you are directed to play out the skit from one scene to the next while others who never even came from this matrix now tell you where you can and cannot stand.

You have been told that the **Phoenix** is a mystical bird that rises from the ashes anew once again, an eternal being that cannot die. Phoenix is a *code word* for the **Script of Atlantis**. A rule-of-law system that was perfected 560 million years ago on Tara Earth to rule unquestioned every Sentient being on surface-earth as chattel and slave to serve the god of the sun. The sun set the time that the chattel followed and played out in a defined sequence for each scene on the **theater** of earth. Each act had leading ladies and brave heroes who would take center-stage to guide the melodrama's supporting cast. The stars would wear wigs and costumes to dazzle the audience and crew alike. The plebeians all wore common clothes, while the spotlight would be focused on the king and queen wearing crowns and tiaras, who everyone hoped would be able to rule over

Decoding The Hive

creation of gravity, light, time and the god particle

their subjects with justice and kindness. But in each act, situations would always arise that made it impossible for them to *keep the kingdom safe* without sacrificing the peasants.

This was *bread and circus* then, and it is still bread and circus now. Your priests and leaders in Parliament wear the wigs, crowns and robes while bathing in the spotlight and the serfs follow their every move in the magazines and newspapers as if deer caught in headlights. They MAKE the rules, and the subjects follow and support the production by playing along as if it were real. Because to them, it is real. Because the stars don't bother to tell them that it is a performance. And their celebrities pick up their same roles act after act as they recycle back into costumes that make them look like plebeians each time, so no one ever suspects they are actually visitors from another galaxy (see more on this repeat-performance process under the upcoming-volume chapters on CLONES).

This is the real **Peter Pan** when between costumes. His god is the illusion of the sun that portions out each act of the play. His flute is the orchestra that dazzles the crowds in mesmerizing notes that blanket the minds of his followers, striking cords that penetrate the electric circuitry of their material bodies and convince them to follow him wherever he dances to. He lives in a mystical land without time where he never ages and he makes all the rules. His people are *lost boys* who continually battle against the clock inside a crocodile along with the hand now replaced by a hook that is used to keep goats and sheep in line. His subjects have been you throughout millions and millions of productions (lives):



The sun does not shine 24 hours a day on earth. This has been shown to you as hard fact at the start of this volume. Yet your time has been portioned out through every second, minute, hour and day to equal “24 hours”. Your calendars back this up in rock-steady allegiance and yet, you continue to lose 1 precise day per each year of your life. And no one explains why or even how that could possibly work out, seeing as January 1st never lands in the middle of summer, as it

Decoding The Hive

creation of gravity, light, time and the god particle

mechanically would, given the offset between how your calendars and watches fail to adjust for the difference between them and the sun's procession. 24 hours each and every year, or 2 hours every single month are literally never account for. Ever. Without so much as a *mention* of it on the news. Something **is up** here; and it's the **sun** called **RA** which is short for **RA**diation.

While you live in a time zone, and all your friends live in their own time zones, there are places where there are no time zones at all. Or more accurately whatever time zone they make up. And you can step into a time zone a few miles away that turns your calendar back or forward in time a full day. I know it sounds like I make some of this stuff up, but I'm not. Here's the explanation from **timeanddate dot com**:

*"Technically, Antarctica, and the North Pole, fall under **all time zones** currently followed by the rest of the world. This is because the longitude lines that are used to define time zones all meet at the two poles.*

Any of the 24 standard time zones (UTC+/-n) or the two non standard time zones (UTC+/- n:30, UTC +/- n:45) would be an appropriate way of keeping time in Antarctica.

*The lack of an official time zone in Antarctica is not a problem, **since nobody lives there permanently**. However, a number of countries do operate research stations in the continent and to make things convenient for the researchers and visitors, each research base determines the time zone it wants to operate in."*

How is it that the sun is not dictating the time of day, if the procession of the sun was the basis for the time dial to begin with? It is because each country has been cordoned off by ownership to differing invader races (*Sumerians*) who run their country (world) "this way", based on "this" **TIMELINE** of technological and belief system advancement the way each ruler desires. Under the Luciferian Covenant, this ownership is real, just as much as the border separating your country from the next is a real place where you have to **check out** of this country before you can **check in** to that one. Borders aren't about keeping the *bad-guys out*, its about keeping the assets of that country in, and if they leave, to keep them in check. The **Eye of Isis Treaty** (also known as the **Camel's Eye Treaty**) delineated jurisdiction of all earth soil (not water) as that of Lord of Earth Samael's (Marduk Satain), and then later the differing quadrant-vectors are portioned out to various *gods* below him.

If you claim *residency* in one country over the next, then the powers have to acknowledge that you have made a choice to belong to that alien corporation over the one you were born in, and once you relinquish your allegiance to another land-mass, your person (fictional *legal person* entity) is traded on the **stock** (chattel) market, handing you and your successors over to the "rightful" owner of the people of that land. I don't expect you to just get this the first time I mention it, as it is so far beyond our scope of understanding we have little frame of reference as to how this could possibly be true. But true it is, and when you sign on the dotted line that you are now a permanent resident of "Argentina", then you literally are moving from one world to a different one with different laws, religious systems, technological resources and **time zone**. The

Decoding The Hive

creation of gravity, light, time and the god particle

Time Zone places you inside of that new world in a way that your owners can keep control over what you do and keep track of exactly where you will be *spending* (\$) your *time*.

You *create* every single day you are alive. Sometimes that is in a positive way, advancing your own life and society as a whole, and sometimes it is destructive of that collective. But each day you choose to “go to work” or to “lay on the beach”, your creativity is manifesting a portion of the collective group of slaves of that geographic location. All the money you earn while you are pledging allegiance to *that flag* is tracked through mind-numbingly sophisticated means, and a portion of the taxes or proceeds of your actions goes to *this god* or *that one* who owns London or Zimbabwe, another portion to the god who’s land you were birthed into. Once you get deep into the **Strawman Legal Person** hidden knowledge, you will see that this is extremely real. While each god (**Pindars**) do have “rightful” claim over your proceeds within their minds, in truth each Time Zone border separates you just like a cattle-fence from other herds, but there is one group who gets at least a piece of those proceeds regardless of where you live.

YOUR CORPORATE INVENTORY NUMBERS

The **CROWN INC** (run by the **Peter Pan Program - Marduk** shown above who works for **An**) of the Vatican and London possesses the **birthright** to all **human chattel**, holding the long-form of your birth certificate in their vaults which bears your **red** blood mark at the bottom. The Lord of earth “owns” earth, and merely leases out to each god below him all the chattel that each lesser god generates in their own “world” (within their respective borders). Humans, as shown in legal dictionaries across the planet do not have the legal right to own land because it is already under lease or outright ownership to someone else:

*Ballentine's Law Dictionary (1930): **Human Being** See **MONSTER**.*

*Ballentine's Law Dictionary (1930): **MONSTER**;*

***Monster**; A **human being** by birth, but in some part resembling a lower animal. A monster hath no inheritable blood, and cannot be heir to any land.”*

Humans are *factually* by **legal** definition, chattle animals that must have an owner. If they are not managed and are merely free range humans, then whoever owns the land they are roaming on is their rightful master. The bloody footprints at the bottom of the deed to your physical body are taken before you are cleaned up at the time of your birth. Your **mark** (as in your footprints you will then *leave on the land*) reveals your prints which are just as unique as finger-prints and only exist on that one document which you will never actually see yourself, because once you are born, that secret document is sent to **stock bonding** (cattle numbering) which places you officially on the international **stock market exchange**. (I have personally seen Long Form birth certificates held in the archives of the Vatican, so this is not conjecture.) The **Long Form Certificate of Live Birth** also carries your DNA, allowing you to be individually traced throughout your life wherever you travel on the planet (through **sifting** your exact frequency), and allows them to clone you at any time they might choose for any reason. With your blood genetics on file, your biological makeup can also be then targeted for pathogen-coding, placing

Decoding The Hive

creation of gravity, light, time and the god particle

dormant deadly pathogens inside your cells which can be activated by the press of a single button, such as mentioned a moment ago, the Zombie Virus known as **pithovirus sibericum** which can bring dead cells back to animation. Though it isn't your Signature Spirit Essence inside this living-dead creature, it is still your once biological Avatar reactivated. (More later when I cover Frankenstein In Real Life in a later volume.) Zombies are real and the sibericum *giant virus* recently uncovered from a 30,000 yr-old ice sample in Siberia only shows that they have been around for a very long time as globally-programmable armies by the Sumerians.

Once the official stamp has been added to the top section of the Certificate of Live Birth after **chattel bonding** making it "official", that document is sent along to the **Vatican Global Inventory Archives** (called *postal boxes*) and the place of origin (the state in which you were born) is then listed as your **official place of birth** which tells them which of the gods (below the Emperor An) is to receive the bulk of your proceeds you will create during your lifetime. This top section is cut off of the lower section and that is the portion of the deed that is given to you should you ever request a copy, and it bears the chattel bonding number (which is independent of social security numbers) if you would like to see this for yourself. It also states that your mother was single which means you are a bastard by legal definition, and why it is the state can claim 100% legal ownership of your body. (This can also be seen on your own birth certificate, as your mother's **maiden** name appears in all capital letters (strawman legal entity) and only her signature is present, not your fathers. Once she signs below this all-capital (corporation inventory is printed in all-capitals) maiden name, she claims that is her actual name, not any "married" name she may have used as an alias at one time. A **Chattel Bond** is known as a **Cestui Que Vie Trust** which gives legal ownership of someone else's holdings (in this case your body as well as everything you will ever earn or possess) to someone else:

Wiki: Cestui que;

"The person for whose use the feoffment was made." It is a Law French phrase of medieval English invention, which appears in the legal phrases cestui que trust, cestui que use, or cestui que vie.

The cestui que trust is the person entitled to an equitable, as opposed to a legal, estate."

The **Cestui Que Vie Act of 1666** was enacted in London (NOT a state, or a country, but a city) during the black plague, allowing the City State to take custody of all property owned by all London residents who were thusly together and in one fell-swoop declared **legally dead**. (There is NO coincidence this was enacted in 1666, the black plague was a **manufactured** genocide.) The state became the trustee/husband holding all titles to all assets until a living man comes back to reclaim those titles through legal channels. It remains this way today for London as well as their subsidiary, the United States (and likely every country of the world). The Chattel Bond number carries a permanent character-code that indicates which **time zone** you were born in, and which vector within that zone ("state"), so the god of the land where you originated from is held in perpetuity as first in line to your proceeding earnings. (More on this subject in a later volume under LEGAL FICTION and the STRAWMAN.) Right now, all I wish to do is establish the fact as matter of lawful record that you are a slave, and you are owned **legally** as trading stock. This

Decoding The Hive

creation of gravity, light, time and the god particle

goes for every being alive who has not yet reclaimed ownership of their **Trust** through **Competency document filings**.

GLOBAL SPACETIME VECTOR DELINIATION

Time Zones are used to differentiate where it is you come from, what **Time Dilation** will be applied to your brain-waves as chosen by each individual ruler. Once you earn a “dollar” or a “yen”, the first portion of your taxes goes to “the Lord”, and the rest go to the “United States god” or the “god of Africa” (Zeus, Apollo, Cronus, etc.). The gods earn according to the world they create, some making far more per person than others, and how much they earn goes directly to their status of their kingdom and the respect factor (called *gentry*) the other gods give them. You cannot *just go to Jamaica* if you live in Switzerland, because you might earn \$10,000.00 on a business trip there that might be overlooked, robbing the Swiss god of his portion of your proceeds. This is why you have to declare if your trip is for *business or pleasure*. If business, then you literally *red flag* your own documents so they will closely monitor your actions. (Never, ever claim business unless you like extra scrutiny.)

The planet might be factually an oblate spheroid, but its quadrants have been laid out in a square grid pattern (celestially) because the reality of the planet works off of the **Metatron Weasadek Phantom Matrix Pentagram/Cube operating technology** (covered deeply in later chapters). This has to do with the way that spacetime fabrics under that operating system are assembled across a grid that is precisely quadrant-vectored, so that each pixel within that Chimera Reality is a square, rather than across an organic Hexagram honeycomb pattern. The 5-point **Pentagram Scalar Vibrational Science** places the points of the **Base-8 operating system** at each of the 4 corners with a zero-point at the center. While a planet might be “roundish” in its visual perspective from a distance, the playing field remains square at the physical level.

The babble program refers to the *four corners of the earth* multiple times, not because the world is square, but the quadrant-vectors that segment the planet’s playing field are factually square, represented in the swastika (which is a very complicated subject that will be discussed multiple times throughout this report). Most earth-maps show the curvature of the planet while spread across a flat-map, but time zones and god-zones do not. It is based on uniform square pixels, exactly like a television or computer screen, because the way quantum particles self-align (such as Gauge bosons across a laser beam) to lay out the spacetime fabric (covered in depth later) follows mathematical vector-spacing across a grid. The lines of the map allow the gods to delineate which times zones can be designated mathematically. While those time zones might appear to you to be crooked or curved from a surface-earth perspective, in real-life those who track the chattel and their respective incomes for taxation do so across **cube-vector** coordinates:

Decoding The Hive

creation of gravity, light, time and the god particle

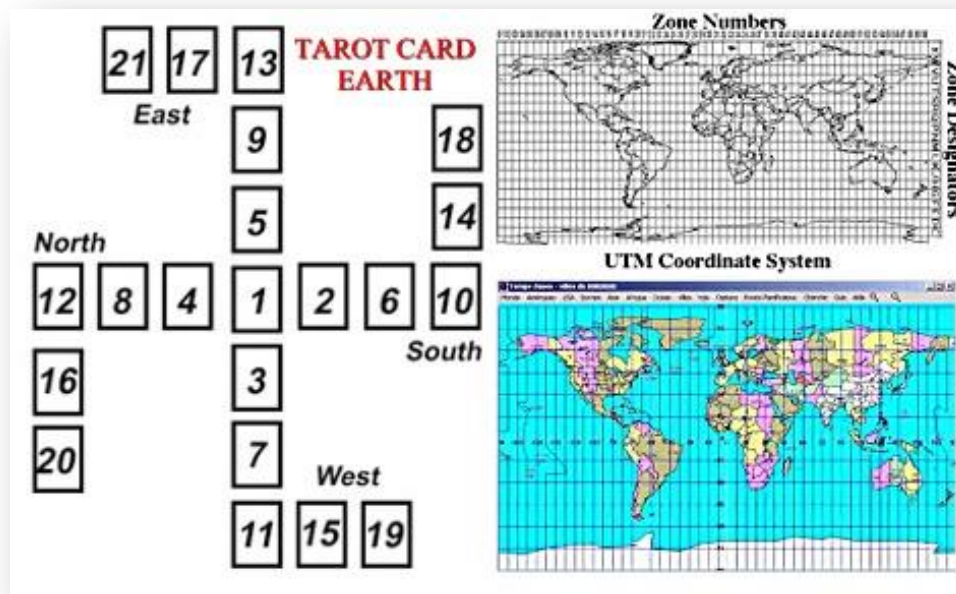

While the tarot card technically represents an absolute square and earth is more horizontally rectangle than square, notice it is laid out in a vertical playing-card shape which shows you that the square can stretch in any direction and all time-related gradients can be accounted for their variants mathematically.

THE MOIRA

In the **Cronus Program** your days are portioned out to you, designated with a certain number, just as you have been told of in different theosophical accounts (by the **Three Fates** or the **Moira** who are *extremely real*), and in more ways than just one. The length of time you are allowed to learn is critical, in that allowed too much time, you would learn too much about the Programs and spoil the punch for your captors. The likelihood of your catching-on and breaking down the system is shown through your provenance from past-lives you have already lived, so they know how many days to portion to you even before you are born again in a new Avatar. And the time you are allowed to deviate from your designated turf is measured as well. This is why you aren't allowed to visit other countries more than "10 days" or "6 months", and why you have to apply for a VISA which strictly limits your stay. What, did you think that the soil under your feet wouldn't be able to hold up under the strain of your body weight if you were to stay longer than 6 months? The exact reason why we are not allowed to stay longer has never been explained to me, so all I can do is imagine what the official statement might be.

Certain gods are **insulating** your people's **era** from theirs because their technology is simply so different, that given enough time in that country, you would begin to recognize the cracks in the armor so to speak. Of course, the internet is breaking this structure down now in little pieces, even though there are rock-solid iron curtains separating internet access from one border to the next. Blogs are written in word processors in one country, then emailed or mailed to friends in

Decoding The Hive

creation of gravity, light, time and the god particle

other countries who post them online where restrictions on that information aren't quite so severe. The wall is crumbling but will not just simply fall overnight.

I explain this to you because this is all part of how time is created from the perspective of both sides of the fence. Time was created as a good thing, then turned into the chains that now bind you by others who make their entire living off of your efforts. There are multiple illusions placed around you in order to manipulate time in many different ways. Borders and Time Zones are just two of them. And each time zone has its own unique particle-spin rate you are located in, based on the morphogenetic plasma field within that **section** (quadrant vector) of earth. The **spin rate** dictates how "fast" or "slow" your experience is going to be, which is dependent on your geolocation.

FLASHLINE SEQUENCING

You are able to earn more magic money if you are on the equator, because you literally live longer than those who live at the north pole or south pole, because the particle spin-rate there is much slower than it is at the poles. If this is the first time you have heard about time dilation, then you will be grappling with this notion I know. But while the *entire body of earth* might spend "one day" all within the same time period, portions of that planet will proceed FAR faster than others getting there, due to the magnetic push associated with the particles zipping invisibly past you which tunes to your body's particles. Due to this, you have more **earning potential** based on which geographic area you live. Landmass segments take this into consideration with how much **stipend** the gods of those areas receive, because if you can produce twice as much as someone living in say, Alaska can, then your borders will be limited compared to the much slower regions. Alaska isn't coincidentally massive in size for no reason, it takes more space for that god to earn enough stipend off of each person than say Enlil makes per person in South America or South Africa by the equator, because they physically live longer in his *world* because the **flashline-sequence** (particle spin and pulsation rate) there is reduced.

Flashline sequencing is the rate by which your awareness flashes on and off (the electromagnetic pulse-rate of your plasma field), which speeds up or slows down the fractions of seconds between the next thing you see. By speeding up the rate by which the pictures pass by the projector lens, your movie will run faster, giving you less time to act out your play and vice-versa.

This is not to say that the days and weeks and years listed for the lifetime of someone in Quito Ecuador is vastly different than the years listed for the average Alaskan, but there is a difference even within the reported years someone places on their tombstone to put a number on their lifespan. But the actual time spent going through a work day increases the further away from the poles you travel. The clocks run far slower as well around the equator to keep in sync with the procession of the sun in order to support the illusion that the sun's rays alone dictate the number of minutes in your day. This is something the average person has never heard a word about before that we will cover in this chapter and later chapters; clocks (watches, wall clocks, computer, cell phone clocks and even *hour glasses*) automatically adjust based on the particle-

Decoding The Hive

creation of gravity, light, time and the god particle

spin of the sub-atomic frequency within the morphonogenetic field of the planet wherever they are positioned.

When you set your watch to “eastern US time zone”, you are adjusting to the **ERA** (timeline) that zone is in (“2 hours ahead” or “1 hour behind” etc.), but the *second hand clicks* of your watch already knows what your distance is away from the poles and naturally slows down or speeds up, depending on location. It also knows how high your elevation is, and self-compensates for the difference (as it continually differs). The reason clocks manage to magically change their own pulse-rate is because under the Cronus Program there is a delineation of time cadence at many different geographic points on the sphere that are being measured by super-computers that run off of aether energy keeping them synchronized by the **Nibiruean Diodic Geodesic Crystal Grid** scalar pulsation codes. Every watch is under this spell (which is merely a Keylon Grid that dictates the parameters in place for all things that are meant to hold iambic pentameter to this program). Hour glasses also follow the time sequencing, because they are crystals, which means they are part of the electronic medium by which electric and magnetic work within this frequency band. They must uphold the flashline sequence of the circadian rhythm dictated by the sun.

Such crystals as quartz used to keep the seconds in your watch flashing precisely are affected by pressure, temperature and

The time procession itself differs between one time zone (land deed) and the next, that progressively changes the further you move away which you can witness for yourself next time you are on voice-over-internet with someone in another country, etc. Notice let’s say from Australia, you are talking to someone in the US, every few moments you will hear a long, drawn-out word that merely sounds like something screwing up with the digital sound. But here’s the thing, often you will hear that word entirely, followed by the next word that now syncs back up to the rest of the sentence they are speaking. That means you just witnessed 2 full seconds of time that were literally never accounted for. And it will happen often, so you only have a wait a few minutes to hear this again. The person in the slower flashline sequence won’t hear it in your words however, because the conversation only needs to “catch up” to your faster flashline. This anomaly has only shown up since VOIP was allowed into mainstream use.

The technology behind all phone companies is vastly beyond anything the average person would ever suspect, that’s why it has been so tightly controlled and often a monopoly during the technological revolution. A **front-company** for the **postal-service**, **Ma Bell**, once *ran* the US after the postal service was largely supplanted as the true 900 lb gorilla of all long-distance communication moved from snail mail to telephony. Prior to cell phones and now the internet, landlines were the only medium by which you could get a message instantly from London to New York. For all intents and purposes and for a very long time, Ma Bell was the only company-choice one had to install such a device. This was because **telephony** (which **TELEGRAPHS** the technology of **the Phoenix Phoenicians**) was so complex due to phase-shifting in real-time the conversations between differing worlds. Only after a very long time was that iron-fist broken up into multiple smaller companies. By that time there were apparently enough human-hybrid **Initiates of the Craft** educated on the technology needed to be applied to the conversation that would allow smaller companies to enter into that “business” field. And there would be no such

Decoding The Hive

creation of gravity, light, time and the god particle

thing as a CEO of any one of them who would not be a very high-ranking Freemason, someone who already knew there were such things as different flashline time-vectors around the planet. VOIP can easily be blamed as “shaky technology” processing two voice signals over distance (at least in our minds), but a direct person-to-person connection could have absolutely zero variance in how your voice would sound to the other person without raising suspicion. But I might just point out that the internet processes trillions of times more data across the globe than Ma Bell ever even dreamed of, and somehow that comes through just fine.....just not your simple phone call?

PLANETARY PARTICLE RATES

This is the sciencey explanation of what is happening with particle-spin rates and flashline sequence differences between each world called time zones. As mentioned, the earth does not spin. It is stationary. The particles that make up the illusion of the planet spin. And they follow an axis-point at the top and bottom where they go in through the top point, circle around in a wide (oblate) band, then enter back into the bottom again to start another cycle.

In the illustration below, imagine the guy standing next to the **blue vertical line (lower-left)** is on a merry-go-round, standing almost in the center where the guy to the **middle-left** is on the outside edge of the ride. Now imagine the men are actually particles. Both guys (particles) are making one full revolution each time together, but the one on the outside is *flying* compared the one in the center who is basically just pivoting around. The one in the center sees the world going by *very slowly*, because he is *personally* travelling at say, 1 mile per hour. But the one on the outside edge is travelling “150 miles per hour” to make the same revolution. Now realize that the guy on the outside is living at the equator of earth, and the one in the middle is in Alaska at the axis or **pivot point**:

Decoding The Hive

creation of gravity, light, time and the god particle

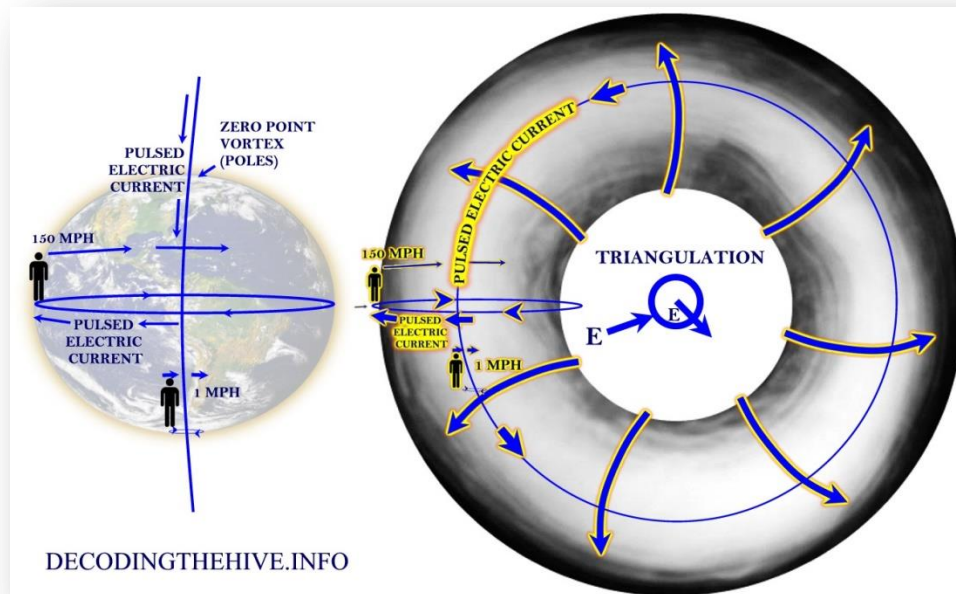

See the two guys and their merry-go-round has then been placed into the donut on the right. The BLUE VERTICAL LINE is their pivot point, not in the middle where the hole is, but in the “meat” of the pastry. Particles flow out from the hole in the center of the donut, around the SIDES (where “earth” is), and back around to reenter the hole in the center from the other side of the donut. Imagine the **center of the merry-go-round** (in the “meat” of the donut) is surface-earth, with the poles of the planet following the path of the curved line. The particles that travel at the upper atmosphere (above the Troposphere) are traveling “150x faster” than the ones at the surface. Likewise the particles that are traveling across the equatorial section where the man to the far left is standing on surface-earth are traveling “150x faster” than the particles at the poles as well. When the particles all reenter the hole, the outside (super fast) particles slow down to meet up with the particles that are traveling at **pole speed** instead of **outside of the merry-go-round speed**. All the particles are synchronized to make the full journey together, just like the two guys at different positions on the merry-go-round, but travel at *vastly* differing speeds to “get home” to the poles, recharge, then make another loop around the Torus field.

If you watch a smoke ring close-up, you will see the smoke curling inside-out continually as the smoke-ring continues to move away. The outside of the smoke ring is obviously bigger than the inside, yet the inside smoke and the outside smoke stay in synchronization because the particles that are “holding the shape of a smoke ring”, know they have to “spread out” (speed up) on the outside, then “bunch together” (slow down) to go back through the center. If particles were not AWARE of what they were doing, what I just explained to you would be a physical impossibility. But it’s very much real, and that only goes to further prove the point that aether particles are just as aware as any being in existence. Science knows this, they just don’t want you to know this. The people closest to the poles are living their lives at super-slow particle-speed, and the ones at the equator are watching the world *zip by* in comparison. Therefore, the TIME DILATION to cause people from both locations to see “24 hours” between each day must be

Decoding The Hive

creation of gravity, light, time and the god particle

different at every quadrant vector-point around the sphere, gradually speeding up as you move further away from the equator.

In an attempt to re-illustrate this explanation because I know this is extremely hard to grasp (at least it was for me), in the illustration below you will see that the plasma field around earth is apple-shaped. Where the lines travel much closer to the planet, the particles are traveling at a *much* lower velocity than they are where they are much further away. This directly connects to time as perceived by movement (your rate of “going through the day”) of when the sun is at “noon until 3pm”. As shown with the donut and merry-go-round above, you will see that if you were inside and close to the center of one of the sides of the donut (at the surface of earth), you would be turning one revolution almost instantly compared to how long it would take you to make the same exact revolution if you were at the outer edges of the donut. If you realize that the particles that travel to the OUTSIDE EDGE of the planet are traveling WAY faster than they are once they reach the north pole, or when they exit the south pole, you can understand that if you were experiencing the “merry-go-round” from either pole, everything would seem “in slow motion” compared to the equator. This is why there are time-zones based on the *length of the life* of the people of each region who are all experiencing their “day” at a totally different velocity:

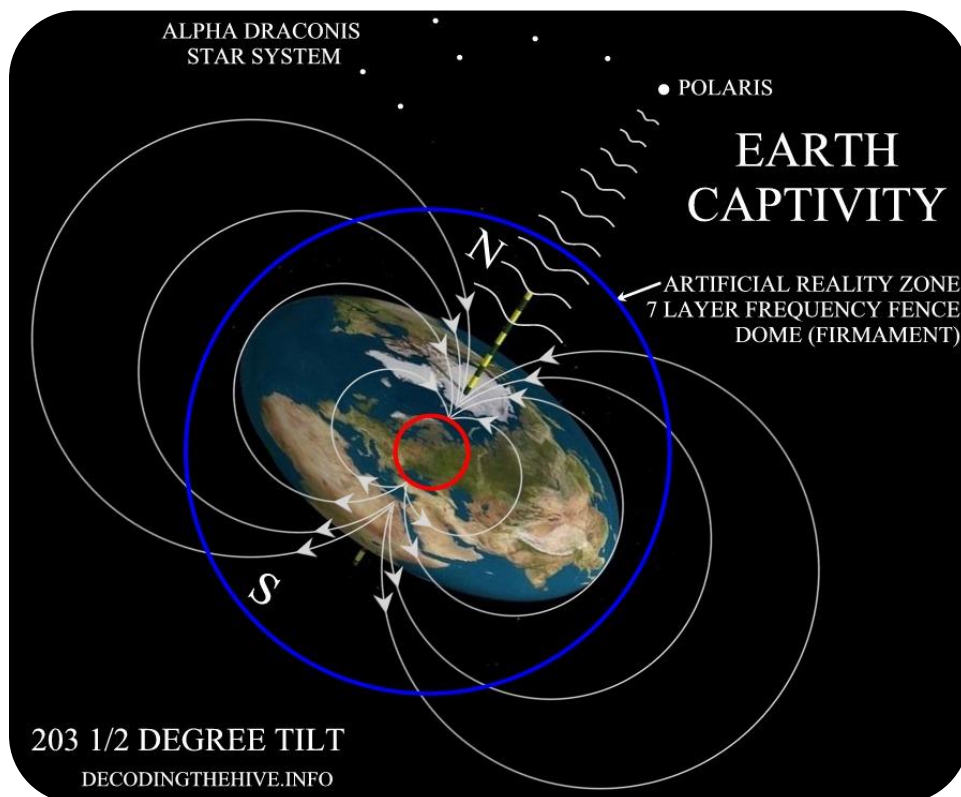

DECODING THE HIVE
203 1/2 DEGREE TILT

Decoding The Hive

creation of gravity, light, time and the god particle

On top of the fact there is this particle-speed difference from the top to the bottom of earth, there is the fact that earth is also triangulated by the particles traveling at a **right angle** to those particles which was illustrated with the donut we previously saw. Then on top of THAT, there is the fact that what you actually *see with your eyes* is dictated by the **pulsation rate** of the waves called **gamma rays** coming from the sun, or from some other source that you cannot see, such as the **individually-tuned Nibiruean Diodic Crystal Grid Temples** that pulses out the precise **flashline sequence** for **that one region** (land deed).

It might LOOK like it is the same “24 hours” between each sunset to sunset no matter where you are standing around the center regions of earth, but the speed of the particles differ greatly as shown. There is no such thing as a sun in the sky that is “radiating light”, otherwise this would all be a MUCH simpler explanation. The invisible rays of the sun ENTER the atmosphere at “6 o’clock” let’s say, so you think you see the sun from “that location in the sky” (rising in the east). But it is NOT emanating light at all. The rays it sends down are merely scalar-mapped time-vector coordinated **frequencies** you **can not actually see** that you THINK appear when they are supposed to “appear” and then “set” when the sun is **supposed to go down** and then the **Lunar Command** then takes over for the next 12 hours. Think of this illusion just like flipping on a light switch in your bedroom if you wish to create artificial daylight to get an idea of how easy it is for your captors to simulate when and where your light comes from. The sections of earth that are in extreme time-zone vectors (again, such as Alaska) observe extreme time dilation compared to the majority of the beings on the planet closer to the equator. Also, the planet itself is not a perfect sphere (as illustrated), but rather an oblate spheroid which plays into the vast distortions that actually exist. It will not be easy for you to grasp this at first, because man has never (to my knowledge) ever heard about how the Matrix works before now, so this will all be foreign to every fundamental concept you might have as to how light works. Luckily, this is far from the end of this report and you will see much more sciencey answers as to how the illusion has been able to be foisted on mankind.

The simple answer is the sun is not a ball in the sky that is hovering around earth, or that earth is circling around. It is a programmed broadcast station that is pulsing out command codes that are currently “tricking” the aether particles that make up the spacetime fabric into illuminating at the flashline speed chosen by each god that is in charge of their granted or leased-lands based on scripts that this dimension of the Time Matrix is now trapped inside of. This illusion distorts everything from how it was supposed to have appeared to give the “time” sensation equally around the planet to begin with when **dual organic suns** projected the correct command codes to keep all of earth’s playing fields harmoniously working in synchronization. Like I said, the technology in place to achieve the Chimera Reality is hundreds of millions of years beyond our current civilization, so it is going to be very hard for anyone to believe that this is a real thing, that anyone would be able to moderate so many millions of lines of code in order to pull off this unthinkable illusion. Nonetheless the reality of their tampering is here and we have to just deal with the fact we have only a tiny fraction of mental ability just now compared to those who have enslaved us.

Again, it is not my job to convince anyone of anything, all I am required to do is show you the evidence, explain what is happening and its up to you to follow it or not. Still, the particles that travel from the South Pole to the North Pole that take the outside route to get there, still make the

Decoding The Hive

creation of gravity, light, time and the god particle

journey in the same amount of time that the inside particles take, meaning they are going twice as fast and the synchronization between all those particles is absolute within your visual perspective anyway. The sun does NOT actually exist as it appears in the sky as a burning ball of something. You are unable to see most of the things in your sky without infrared goggles on, and if that simple device such as a mere set of glasses can be that effective in enabling your vision, just imagine the technology behind a device that was designed to scramble what someone doesn't want you to see **at all costs**. Then maybe you will begin to get the picture that this is going to be incomprehensibly complicated to ever understand. You will either want to understand so badly you are willing to continue to read and take notes, or you won't. Either way, this is me doing my job to make the answers available because this is when the public is supposed to finally know the truth.

MUTATED SEXTANT CLOCK AND THE SECOND SUN

Before the distortions began with the **Mutated Sextant Clock Event** 250 million years ago, there were two points outside of earth (two suns) that radiated frequency waves into the particles (water particles) of earth atmosphere that kept a uniform "daytime" at all times so humans wouldn't have to experience darkness. The tilt of the planet's **Sextant** was disturbed in this event and then later it was more dramatically altered in **9540 BC**, and then again around **150 A.D.** furthering the dilation **even yet**. Today with only one point of reference of "day time", and then a different point from the moon for "night time", people now live MUCH faster lives from birth to death as illustrated in the biblical stories surrounding life-spans before and after the flood. That was due to the continued manipulation of earth's spacetime flashline sequence coordinates.

In order to overcome these distortions, the "gods" divided up the surface of earth into *time zones* in order to more equitably proportion how much **lush** or *magic-money* taxes would come to which god according to status, based on how much actual production time each of the livestock would be able to produce in their given lifespans. When nights are months long at the poles, do you really think that the sun is governing time? Of course not. *Time* is apportioned out by the rate of speed of the particles that actually produce the light which differs depending on where you are standing. People who live in arctic regions live 3 years longer than those who live at the equator to give you a frame of reference to this subtle difference. Those years are from the separation they have from their time zone and others, just like life spans in the 4th dimension are different from those in the 3rd.

When you are in a plane looking down at the cities below, look at the freeways and notice that the cars are traveling in slow-motion. Why is that? Because to travel around the world from 3 miles high above the ball of earth, you are now in a completely different time zone where things move at an extremely higher particle-spin than closer to earth surface. Energy speed differs between one quadrant to the next based on how far the particles are away from the ZERO-POINT where their energy command comes from. Next let's look at how space and time are created.

CHAPTER 12

CREATING SPACE AND TIME

Decoding The Hive

creation of gravity, light, time and the god particle



How spacetime is created is through aetheric **mechanical** means. Until there are spacetime pixels set in place, there is no “life” that can then be placed into a linear construct that allows us to think of something having happened yesterday, or a year ago, because time isn’t an actual, real thing. We have always had spacetime to move about in during this life, so we think this is just how it is, but that can only be said for a handful of beings who are in a corporeal, manifested state. Many beings choose not to manifest and simply experience eternally without hands and feet. Others choose to become mortal (in varying degrees) so they can experience a heightened sense of interaction that will include touch, taste, smell etc. With this choice comes increased risk of course, just like choosing which car you are going to drive around the race track in an attempt to experience some thrills. The more powerful the car, the more chances you have to crash, and also the more others will want your vehicle for themselves (t’was always thus, and I suspect will always be this way in such lower dimensions where people have yet to learn that there is no such thing as taking anything, even a stick of gum, and actually getting away with it). Those who have chosen corporeal existence and then were mind-wiped upon rebirth have no idea

Decoding The Hive

creation of gravity, light, time and the god particle

of what they have done in past lives, or who they are today (from what star-group, if any). This planet is a melting-pot for beings from across the cosmos who have been one-by-one ensnared by clever people who then use their energy for their own selfish gain.

This is a big topic, and I only briefly touch on it in this section to establish for you what **Quadrant Vectors** are so you can get some idea of how “time” is manufactured. I will explain much deeper the situation that the abductees find themselves in throughout this report as well. Since you come from a place where there is nothing to begin with other than thought and energy, everything is a **creation** outside of that (empty) reality. Time and distance (time/space) are created, just like a flower is created into existence. Time isn’t random and time is just as variable as the speed at which your car travels around the racetrack. In real life, a god (you), can experience 100 races on that track instantly, or they can be broken down into 100 different races filled with adrenaline-induced anxiety to navigate each and every turn if you so choose, stretching out the experience much like extending love-making or savoring wine by small sips let’s say, so you can continue the event as long as possible.

PLAYING FIELD MAPPING

In video games (modeled after actual Time Matrix Sciences), you will turn on the game and find yourself let’s say inside of a dungeon. There you will stay forever until you DO something. That act is generated by the **spark** of your imagination (only members of the god family have this spark) and it cannot be manipulated to be cleverer than the level of your intrinsic abilities. You can either imagine there might be a bomb inside that chest you can use to break out with, or you can’t. Likewise, only your awareness can then decide to kick the chest to try to open it (which will never work), or do a dramatic acrobatic sprint across the room, leap into the air, spin your body around and then deliver a ninja power kick to the box to increase your velocity in order to deliver a blow that will be enough to overcome the locks and latches keeping it sealed. As explained, Signature Spirit Essences (self-aware particles of god-source) come into manifestation with differing levels of comprehension than others. It has always been this way as there is no such thing as “all men are equal”. Though every member of the god family has identical *potential*, each one is unique and some are simply cleverer than others (at each one’s given point in learning). You might be in real-terms, 100 years old, but your buddy might be 100 million years old. He *will be* cleverer than you are.

Within this reality, the only thing that serves the Spirit Essence to begin their journey is their ego which tells them to either believe in themselves enough to attempt such flying ninja gyrations or dismiss those notions as wastes of energy and time. Some find their way out of the dungeon, some don’t. Those who do are clever. And the cleverer they are, the more they begin to believe in their ego as their only real tool they can use to experience more of the game. In reality, your abilities are only limited when you choose to come into manifestation, as your higher-self in the **Deity Planes** knows everything and can do anything. But the **BODY** of who you will be once you choose to enter into an Avatar in a mortal form will not be all-knowing and all-powerful, because those abilities are dictated by how rounded and balanced you are once you come into your own Self-awareness. This is no different than having two children where one can do anything and the other one can’t tie his own shoes. If you were to come into manifestation to

Decoding The Hive

creation of gravity, light, time and the god particle

have some fun, and you met the wrong people who were a hell of a lot more clever than you are, and they choose to use your Avatar and your mind for their own fun, you become their slave. No one plans to become someone else's slave, but it happens anyway. If you are reading or listening to this right now, you did come into manifestation and someone did make you their slave. This goes even for those who think they are the slave masters enslaving everyone else around them, because someone is pulling your strings too. That means 100% of everyone in this kindergarten sandbox, no exceptions Anu. Even the most clever and powerful Avatars of all creation (Elohim) who find themselves playing out this eternal childish game were infected by the **Budhara Retrovirus** (Nanites), and they too are slaves as well (see the chapter on Artificial Intelligence).

This brings us to **Spacetime Quadrant Vectors** which are the tools by which you are able to experience mortality within a holographic Avatar and which also can become invisible bars in a dungeon keeping you from getting back to more enjoyable video games (Time Matrices). If you are ever going to break the cycle of permanent enslavement, you will need to know how your prison bars have been constructed by very clever Self-aware Spirit Essences. Keep in mind every one of these beings are your family members, brothers and sisters all playing in a sandbox together. They are not here to *destroy you*, even if they trick you and make you cry. They are just there to have fun and experience, just like you are. If they just so happen to be smarter than you are, they will eventually use this to their own advantage to have more fun, or they will be more mature than that and leave the sandbox so they won't wind up tricking you into eating rabbit pellets just to get your reaction when you figure out they aren't really chocolates.

Applying a bunch of spiritual nonsense to your situation is a distraction designed to keep you occupied so they can extend the game. You are not some "*Ruby-Diamond Level-60 Reiki Master Gestalt*" or a grand-poobah wizard of the universe. You are a child with the last name of god, just like everyone else with the blue-flame spark who comes into an Avatar to play in sandboxes. It is going to be up to you to either continue to listen to your ego so you can continue to extend the play of the game, or you are going to realize that tricking your sister into eating rabbit pellets isn't something you want to continue to do for eternity.

SCALAR GRIDS

Decoding The Hive

creation of gravity, light, time and the god particle

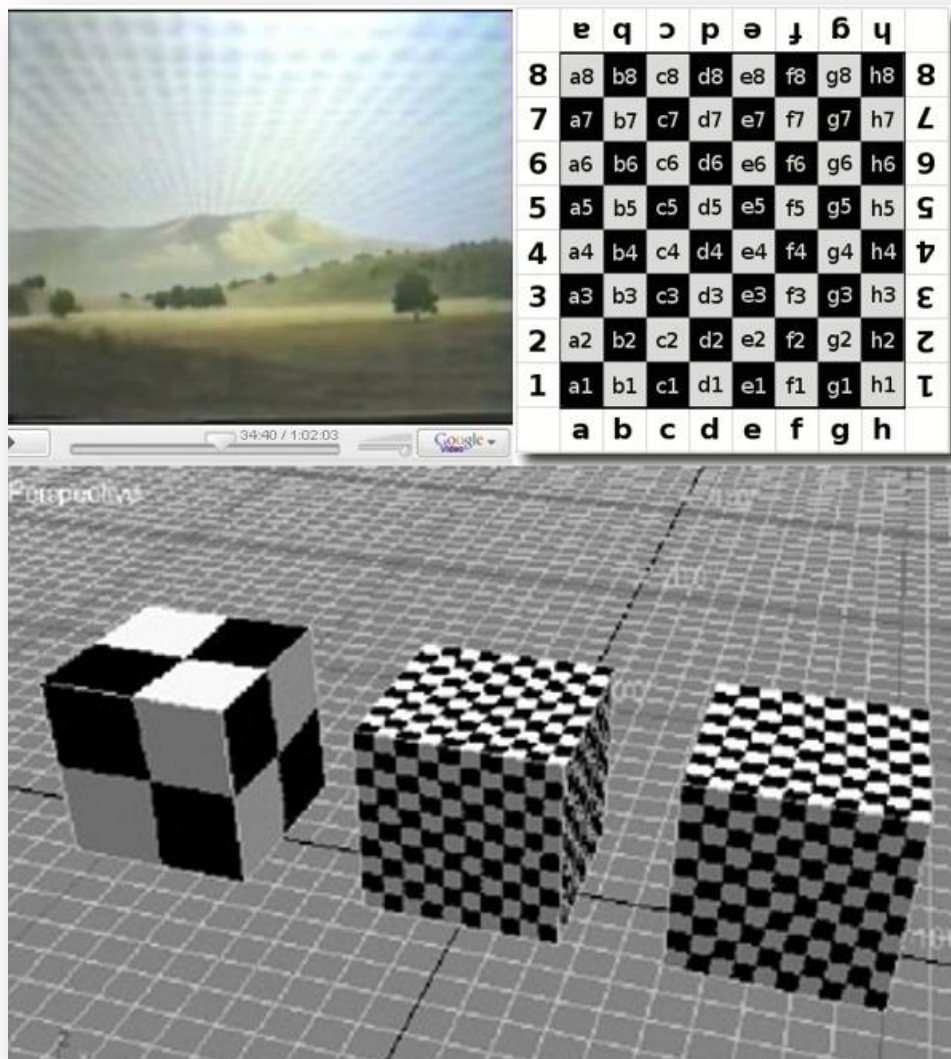

A mechanically-simulated **scalar map** is made up by beams of light (photon) particles that travel across any section of any space, equidistant apart. If you place phase-pulsation lasers side-by-side each other every “inch”, this lays out a map. The laser functions on a precise pulsation that never deteriorates, regardless of distance. Those pulsations are timed, which means that every “inch” there is another pulse, which gives that point in space a number. In easy-to-understand language this simply means that “25 pixes UP, and 25 pixels over is 2525”. As you will learn in following sections, laser light is a special frequency that is in the same bandwidth of Y and Z Gauge bosons (quantum particles). These particles hold the coordinates of every fraction of inch within spacetime. Spacetime is simply a word to depict a playing field where holographic existence is possible, such as found inside **Time Matrices**. In this mechanical example where you are emulating a scalar-grid, each grid you create using laser beams - let’s say “all of space” - is then broken down into **quadrants**. Then, inside each quadrant or exactly $\frac{1}{4}$ of that space, is placed another grid which then delineates into quadrants again, and then again, and then again,

Decoding The Hive

creation of gravity, light, time and the god particle

until you have a SCALAR GRID for every “square inch” of “all space” that you can apply a NUMBER to each square or *pixel*. You do this for every inch side-by-side, and front to back, so just like the top right image above of a chess board, every single *one inch* square has a number, or **vector**. Now you have a number for every horizontal inch, and every vertical inch, and each one is numerically sequenced, allowing you to locate instantly any inch within the entire fabric. Within that **vector**, I can tell the computer to “go cast a hologram of a chair” right there in that pixel point and nowhere else.

The military uses scalar mapping constantly and tells the public it is the wind, water-currents, etc. It just shows how gullible we are and willing to believe anything we are told. It is a physical, scientific impossibility for wind or waves to produce the patterns seen here. The ocean is weaponized and was used to target Fukushima nuclear reactors in 2011 with pre-set, ocean-floor tactical nukes from the comfort of their arm chairs at the Pentagon to force Japan to sign the Trans-Pacific Partnership deal. Immediately following the attack, they did:



Decoding The Hive

creation of gravity, light, time and the god particle

Every sub-atomic particle of **all of spacetime** has been scalar mapped by **Gauge bosons**, which are 2/3rds of the Trinity force that delineates the “projection screen” of earth as you will see in later chapters. They are quantum-entangled, so they simply agree among each other which pixel they are going to hang out in to provide the flash that will “create” reality for that quadrant vector pixel. Each particle is standing right there in order to function as the **projection screen** of that precise pin-dot of manifestation space. As you can see in the previous image above top left chemtrail targeting and immediately above in the ocean, humans know about scalar mapping, and they have for a very long time. They use it for weather manipulation as well as every possible nefarious agenda that the human mind could imagine, and many others that the human mind wouldn't be able to imagine because humans don't think like vampires, they think like humans who have been coded to compassion. That compassion can be derailed and replaced with *some* level of lack of morality, but not completely. Those who go around shooting each other are good examples of how humans have been recoded to stupidity through **brain mapping** that **vectors** off the human mind in the same way as explained here, then precise points of the brain that regulate hate or violence are simply targeted to *do this*, and then the body obeys. That is called RNA command that takes over the actions of something or someone else, below the DNA level. If the person who is being remote-controlled still has any intrinsic common decency within their Prana Seed, they can resist those messages and tell the frequency waves: *NO*.

This is a TV or computer screen:

Decoding The Hive

creation of gravity, light, time and the god particle

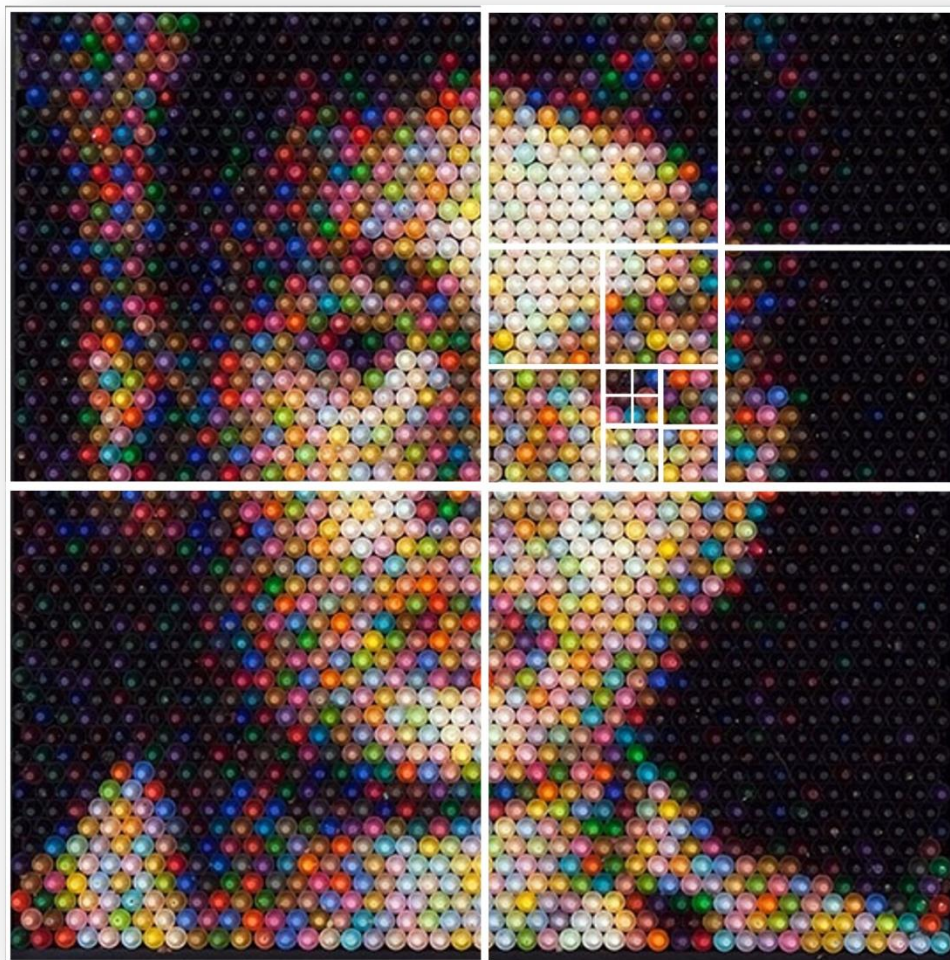

By **scalar mapping** the screen, I can tell you that in *quadrant vector 90434*, I want three slightly different colored pixels at 435C, 436C and 478C sub-vectors to make up the retina of the eye of the person number 9043-D,635Z,436B,978H.

Each pixel that holds the space on the screen above is working that vector of that one screen. The little boy in the picture is not going to jump off the screen and walk around your living room. You can only see the boy *there* in that one dimension. But if you put 20 million tv screens in front of this one, you could see him not only walk from side to side of the screen, you could see him walking physically towards you in your room, giving him a 3rd dimension to move about in.

No matter what the boy does in the hologram, the **pixels** will never move *from here to there*. Spacetime pixels don't move either. The **energy song of the crystals** traveling **through** each pixel does, but not the spacetime vectors themselves. That means as you walk from the middle of your room toward the door, the particles that you are "made out of" do not *travel with you to the door*. They stay right there, and as you **pass through** the pixel particles of aether, "you" become illuminated into what looks like reality. Of course your hologram is much more technologically

Decoding The Hive

creation of gravity, light, time and the god particle

advanced than your TV screen is, but they operate in the same basic way. It's just that in the Time Matrix hologram, the little boy has feelings and emotions and feels pain.

“E-motions” stands for ELECTRIC motions, or *sensory animation* within a biological life form (or even inside a completely mechanical entity such as a robot or nanite). If you can FEEL or SENSE something, then you have an ELECTRIC physical response to the particle's manifestation within that animation or *e-motion*.

In a CRT TV, there are photon guns that shoot colors at the screen pixels, illuminating them red, blue, green, or varying shades of such. Each shade of **color** is a **frequency**. Each **frequency** has a **code**. Every **code** has a **number**. So, in real terms, I could either type out **bluish yellow**, or I could type out 344,545=334,523,235,2509. Either way, I can tell that one pixel at vector **here** to be **this** precise color. And realize that each pixel's job is not to “create a human” or “create a tree”. It simply creates one single color held by the image of that person or tree. It is merely producing the shade of part of one fleck of gold in the cornea of an eye, or “a single dust spec”. This is not magic. Your computer screen uses the exact same technique to project images that look as crisp as a shiny-new penny:

Decoding The Hive

creation of gravity, light, time and the god particle

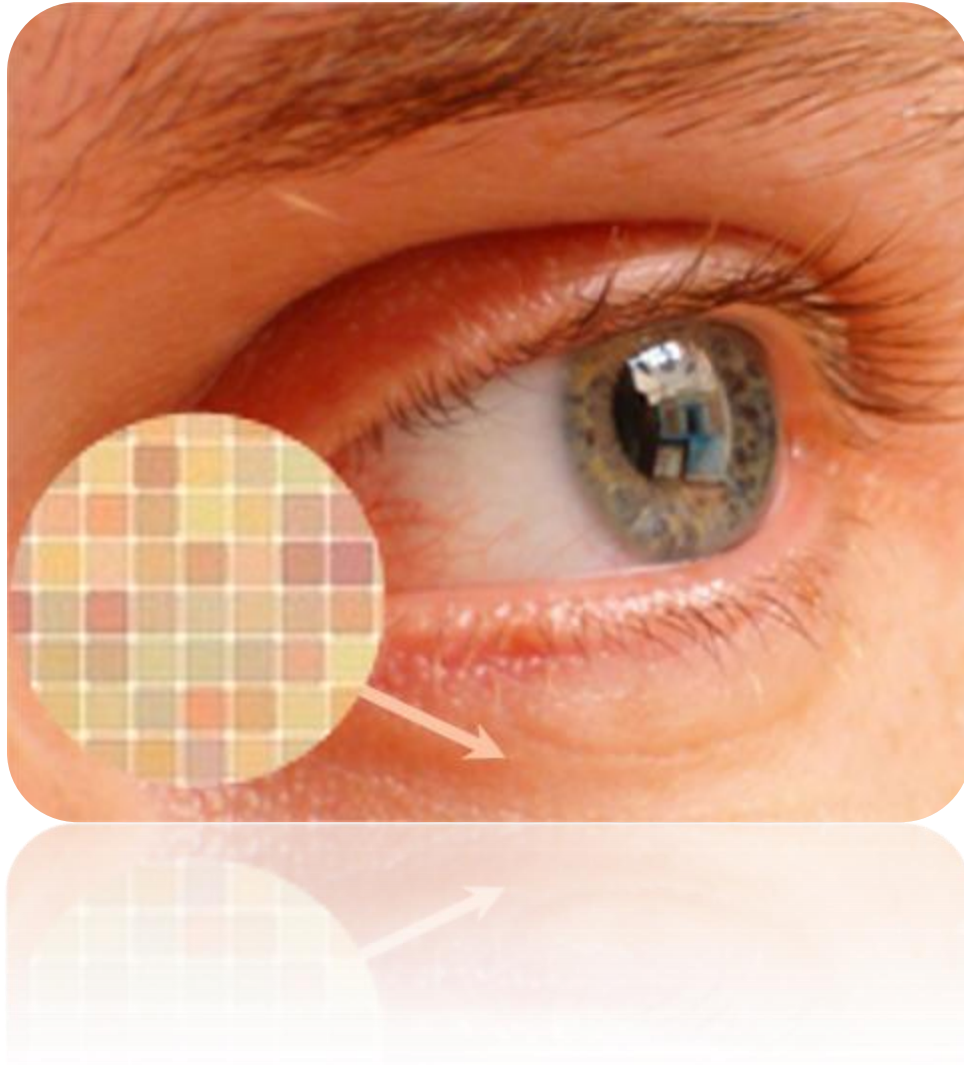

A **photon gun** laser is an electromagnetic command device that takes electricity, turns it into light, then sends that light exactly where you want it to go. A **Sentient being's** *thought waves* are *photon guns*. Our photon guns we use in TVs are merely the **mechanical emulation** of what a Sentient being does organically, just like a robot is a **mechanical emulation** of a Sentient being.

When you *open your eyes*, you expect to see a TV let's say. When you *turn on* the TV, you expect to see "the news" on the screen. Same thing. As long as you aren't *listening* (WILL) for the TV sound, expecting to *touch* (WILL) the TV case, expect the TV to *exist* (WILL), or expecting to *see* (WILL) the TV and you are the *only* Sentient being in the room, then **that TV does, not, physically, exist**. And that has been proven hundreds of thousands of times around the world in the quantum **Double Slit Experiment**. Sentient beings EXPECTING to see a TV will see it. Dogs and cats and robots **cannot see** the tv unless you WILL them to do so. **Factually speaking**, dogs and cats and other robots do not have photon guns inside of their mind. Their artificial eyes can *mechanically* see a TV that a Sentient being creates, **only if** a Sentient being is observing it (**willing it** into existence), but they can't actually bring that TV into existence and they can't see it unless the Sentient being is aware of the TV's existence in some way.

Decoding The Hive

creation of gravity, light, time and the god particle

*Aether particles literally do not manifest FOR (work for) non-Sentient beings. Non-Sentient beings can only see what is being placed into existence by a **family-member of god-source**.*

FLASH LINE SEQUENCES

Flashline sequences are used in holographic projection. What you see is flickering on and off at all times. They are flickering far too fast for your eyes to see the refresh rate pulsation (now-days anyway), and just as a movie projector flashes one picture after another to create the illusion of movement, you can't actually see each frame of the movie. All you see are 50,000 still pictures strung together that look like a "movie" named after "**moving pictures**". Your TV screen or computer monitor works through flashing on and off, and your physical body does the same thing. *Even modern Science will tell you that nothing is static. There is no such thing as anything in existence that doesn't **appear and then disappear**.* Quantum science makes this abundantly clear, that the flashline sequence is happening at all times with all things. "Matter" can't do that. Either its there, or its not. If not there this second and then here the next, then *where did it go?*

Aether particles power the pixels of the spacetime fabric. At the end of a cycle of manifestation, all particles, regardless if they are a light photon, or a steel particle (same thing) or a water particle, manifest through one cycle. That will take 1 trillionth of a second, or they might cycle a few times while that leaf is static in that one spot, until the wind blows it into the next quadrant and the particles there in that "sheet" of the grid light up, showing you "the leaf is now over here". Regardless of which particles are lit up at the moment, the message behind that action remains in action until the full **tour of duty** (called a **mission**) for that command has been completed. It might take a trillion-trillion particles to complete that tour, and it might take 50. The particles themselves aren't depleted, as they carry enough energy for millions of flashes before needing to be recharged, plus they continually power much of their own energy as needed within each flash cycle. The **crystals** that carry this energy do "move" however, which will be covered later. Even then it is still **holographic**. The **pixel** never moves, but it appears that way to science. All you are *seeing, touching, smelling, tasting or hearing* are pulses in the projection screen of that different or separate "sheet" within the "fabric" of the holographic spectrum simulating *electric motion (e-motion)*.

The **pattern** particles traveling within **that one pixel** *print* out a geometric command of a certain color-code. The color-code for that 1/000th of a second is carried to that pixel by the **god particle** as explained shortly, which carry all the parameters of the entire mission. Just as one cell of your DNA carries 100% of all the command codes to recreate your entire body in a cloning pod. And of course man has known about the command codes within DNA for a very long time, and have cloned animals, plants, bacteria, and humans, **millions** of times since. They know they can duplicate **exactly** what that person is supposed to look like, or **exactly** how big that cow will be if they simply stack the DNA sequence precisely as it had been in the original DNA cell. *That DNA cell is nothing more than a different mathematical language than you are used to, using geometric patterns instead of numbers because geometric patterns work millions of times faster than stacked or sequenced numerical equations. Just ask any quantum computer programmer*

Decoding The Hive

creation of gravity, light, time and the god particle

who uses Qubit Spheres instead of 1s and 0s. Remember it was mentioned here before that all things, down to the lowest level of creation are spheres. Quantum computer science knows all about this which is why their *geometry* creates *geometric* spheres called Qubits. Keylon Templates are also spheres, but shown here in 2D form so they can be easily illustrated on your screen.

CREATING THE FABRIC OF SPACETIME

Now we get to your own movement walking from the middle of your room toward the door on the other side. As you can see, at each different **scalar grid** (*fabric sheet of spacetime*), the particles that “*look like you*” flash ON when the command sequence reaches that **pixel** of the **scalar grid**, then flashes off, then appears again at the next scalar grid you are walking through:

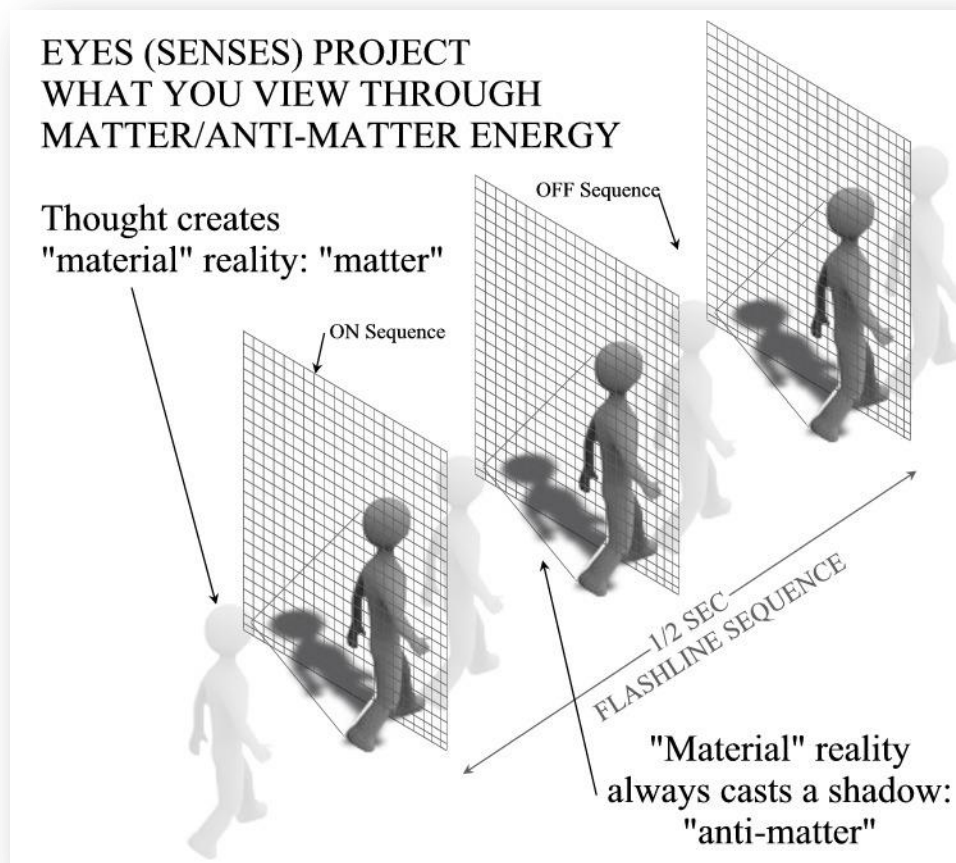

*As long as I convince you that **you** are the image on the screen, and not your awareness that is casting that image, then I can convince you that you are “mortal” and subject to **my command**. The moment you understand that your awareness is eternal, then you will stop projecting your image onto the screen and that game is over, freeing your awareness*

Decoding The Hive

creation of gravity, light, time and the god particle

*to enter a different game. The only beings that can ever “die” are beings we created with our awareness. Once we stop projecting them into reality, they vanish. But because they look and feel real, we believe they are the same thing as we are. This is not true. Only members of the god family can “create” anything as I continue to repeatedly redundantly repeat. Everything else is simply a construct of what we (the collective of the god family) manifested in the first place. We can un-manifest these as easily as we manifested them. But we need to be in **agreement** on what is “real” and what is no longer there. This is why the world continues in the condition it is in, because they remain separated through wars and races and sports and other mind programs humanity is under. First you need to be able to communicate, once you do, you find out that humans are human(e). It is only your captors the Nanites who are the absurd monsters you think you are seeing on the news who appear “human”. **They are not.***

This is the essence of free-will-choice. You agreed to enter into this Time Matrix (whether you were tricked into that or not, you chose through a combination of your actions to be abducted, whether that happened in 5 seconds or 100 million years). As long as you are here, then you must “exist” under the agreement that this is not 100% of your own creation, and you are then forced to work as a team to either continue to manifest this hologram and are at the mercy of your other partners in this creation to continue to experience what the collective chooses to experience. You must reach a 51% agreement between the creators of this game in order to turn it off, or you must leave the game yourself, and exit the hologram alone. Your partners have hidden the exit door. That is what we are here to show you how to reach if you are ready to “turn the key-lon”.

If your Self-awareness is inside of your AWAKE body, then your Awareness will now act like it is inside of a body for material manifestation. Thus, the **scalar grid** will allow you to sense sight on your “way to the door”. Your **awareness** will “project” the image of yourself along with the world around you, adjusting your perspective of reality angles and colors and textures as you move your awareness “from here to there”. If you were to zoom in on the **grid sheet** that illuminates “what you look like” down far enough, (in effect, slowing down time), you would see your body flash on and then off, then on again, just like quantum particles do, as your awareness reaches the next grid, and the next grid, etc. Without the **scalar grids** within your Time Matrix, you wouldn’t be able to sense the difference between “walking”, “sitting still” or “running”, because there would be no *frame of reference* for the motion or lack thereof. That is why you have to enter inside of a 15 Level **TIME** Matrix in order to enter into manifestation in order to create the illusion of *TIME*. Or for *baby Jesus to enter into manifestation below from heaven above*. Above is talking about higher *frequency spectrums* than the one you can view, or completely *outside* of manifestation called the Deity Planes where all there is, is thought and static (dormant) energy.

When I change the flashline sequence structure of your spacetime fabric, I can change what you see, touch, smell, taste and hear *just like changing the channel on a tv*. The Weasdex Phantom Matrix Metatron Scalar Science held in the geometric shape of the **PENTAGRAM** is an *OPERATING PLATFORM* for want of a better word. When you stick your video-game cartridge into one video game console that was made for a different player, if it plays at all, it **WILL NOT** appear like it would inside the platform it had been designed for. The “reality” that you see

Decoding The Hive

creation of gravity, light, time and the god particle

inside of this console-within-a-different-console *is not real*. As long as you continue to act like it *is* real, *then it will continue to be your **actual reality***.

CHAPTER 13

PIXELS OF THE SPACETIME FABRIC

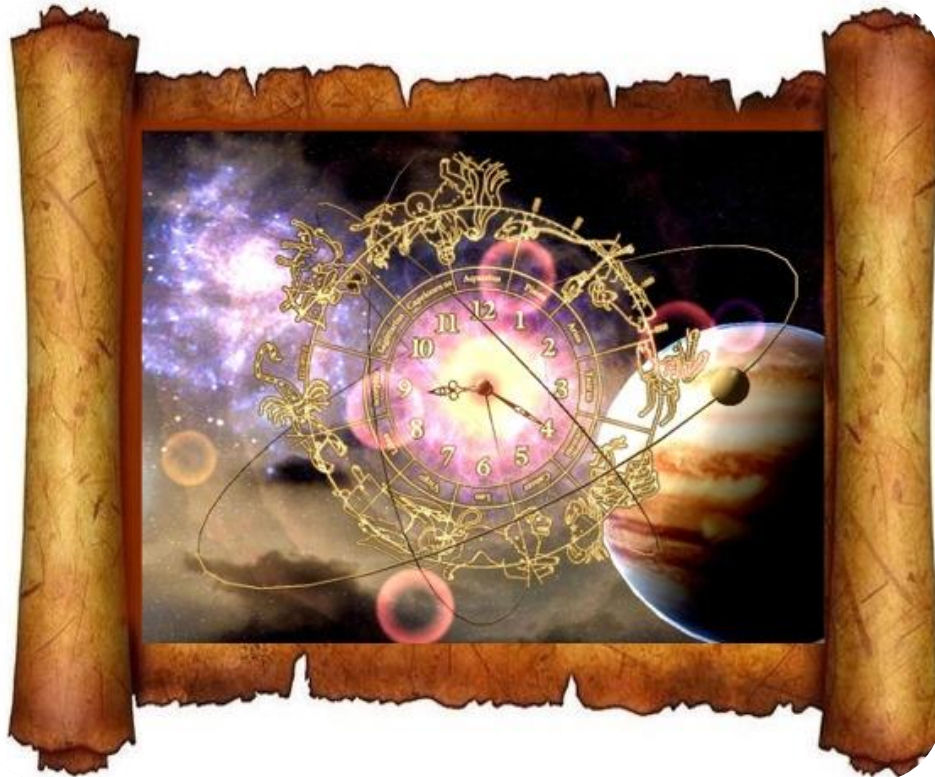

You will now begin hearing about **Deuterium**. This is a **big** subject. Science likes to say that stars *eat* Deuterium, that *it is destroyed in space*, not realizing that Deuterium is part of the Earth's **Silicate Matrix** to support **life**. **Space** is not meant to support **life**, as it is not within the boundaries of this playing field, that's why Deuterium isn't found **in** space. Space **is not** a *playing field*. Think of the **playing field** I continue to mention as being the **edges** of your **computer screen**, as mentioned. Within those edges lay the precisely-positioned pixels of what is called the *fabric of spacetime* where things can dance around and sing and perform. Space between planets is just like the space between your computer screen and the next computer screen, where your computer simply has no possible way of projecting an image there, because there are no *pixels* there. (Keep this in mind, as I will be addressing *space travel*, because what you have been told about space has been a cacophony of the most outrageous notions of

Decoding The Hive

creation of gravity, light, time and the god particle

nonsense, giving you the illusion that you can simply walk right out of your computer screen and to the next one as long as you have a *rocket* to get there. Interplanetary travel absolutely does exist, just not in the way you think it does, and it is not for 3rd Dimensional humans.)

Within your computer screen, pixels are made up of points within your visual field that have been numerically and sequentially defined through scalar-positioning, exactly like earth's life-field has been defined. In the Wiki explanation below, you will see that how a holographic creation is projected onto a screen is through "spatial positioning" that correspond to "timing mechanisms". This creates a "*space*" by which something can be seen or *manifests*, and is connected hip-and-waist to *time*.

Wiki: Pixel;

*In digital imaging, a pixel, pel, dots, or picture element is a physical point in a raster image, or **the smallest addressable element** in an all points addressable display device; so it is the smallest controllable element of a picture represented on the screen. The address of a pixel corresponds to its **physical coordinates**. LCD pixels are manufactured in a two-dimensional grid, and are often represented using dots or squares, but CRT pixels correspond to their **timing mechanisms**.*

*In some contexts, the term pixel is used to refer to a single **scalar** element of a multi-component representation, while in yet other contexts the term may be used to refer to the set of component intensities for a **spatial position**.*"

If I project your image for you, then I can project the *time* by which everything is observed or experienced, right down to the last element within that field (like your DNA). Your spacetime has been hijacked using this process which applies more elements than your computer screen possesses, but it is still a very accurate analogy to describe how something can either be seen, or it can't. Even if you can't *see* it, it can still be projected in to adjust everything else you *can* see. Our world is an operating platform with trillions of *spatially sequenced scalar-vectors* (pixels which are *picture elements*). And since you can't simply walk through billions of glass-screens holding up trillions of pics-els to project the colors before you, we don't use physical screens, we use water vapor powered by Deuterium. The water vapor isn't just something to project **on** to, as you will see in a second, but in the case of the spacetime fabric, it is what actually **projects** the image itself.

Even in your own fields of holographic imaging there are such things as dry water-vapor projection screens that you can freely walk through that will show a fairly clear image of what you are trying to project. Given only a few more years of development, man would be reaching very life-like reproductions in 3-D such as you see each other walking around now. Though man is still eons of time away from giving them density and sensations such as life appears around you, this gives you an idea of how it is that water vapor, be it opaque or completely invisible, can still render the image:

Decoding The Hive

creation of gravity, light, time and the god particle



LIGHT BENDS

To understand more about lensing dynamics, and how it is that water vapor can be used as a magical video screen, we need to talk about how it is that light is refracted and how it bends so you can understand more clearly how it is that the spacetime fabric is able to project any level of diffusion and deflection of the colors they emit which allows your captors to dictate what it is you are seeing just by causing the light to tweak a *few degrees* from your direct view. You have noticed in the early days of big screen television that if you moved away from direct-center of your screen, it would begin disappearing, and when you sat right in front of the screen it was colorful and clear. In this case the image you were seeing was projecting through plastic, but at its quantum, that plastic carried the same active particles in it that water does, just not nearly in as great of quantity, which gave that screen a decreased ability to display the images. Today's TVs use much greater levels of those particles than in yesteryear, so now if you can see the screen, you can also see the picture vibrantly.

Decoding The Hive

creation of gravity, light, time and the god particle

Things in space are being refracted to your view in a similar way as to how that plastic screen operated, which diffuses your view, and also distorts the image so you see everything as round dots, even if where they actually are they might be square, flat or shaped like a falcon such as the actual shape of the biosphere that the **Interdimensional Association of Free Worlds** uses which has been visibly parked next to our sun since around 2008 when the **Jehovah Anunnaki** (dolphin people and creators of the **Anunnaki legions**) reentered the **Emerald Covenant**. Here, it appears as a ball (on the right):

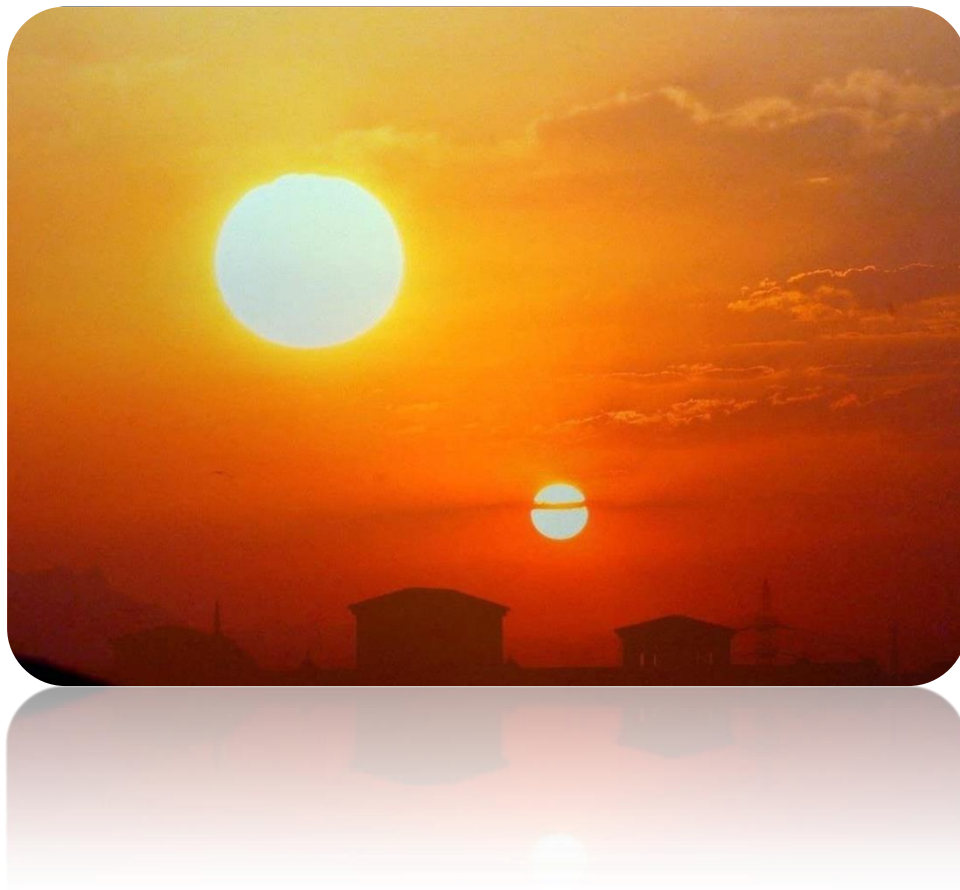

The **Nibiruean Battlestar** that the **Anunnaki military** inhabit has been parked there next to the **IAFW** and the sun since this same time to look after the transition of their hybrids under the **Co-Evolution BioRegenesis Treaty of Palaidor**, so they are now working together through this **Stellar Activation Cycle**. The **IAFW** craft is remaining visible for this time in order to prepare people for the transition, but the **Battlestar** is going to remain phased-out of view because it would be too startling, at least at this time, for people to witness (it looks just like the Death Star craft in Star Wars).

The **IAFW** can be seen with online telescopes such as **SOHO** or you can just view the dozens or hundreds of images already shared online from that site and others that are already out there. Unless you use special telescopes that filter out particulate interference and bring what is actually there into focus, all you will see are dots due to the lack of the particles that allow the picture to radiate clearly. Space was meant to seem like an impassable expanse for deliberate reasons. All

Decoding The Hive

creation of gravity, light, time and the god particle

but the top left image also from SOHO was taken by me personally immediately following my education process in 2013 within just months after the opening of this ascension cycle:



By now you have heard cosmologists and theoretical physicists refer to the bending of the fabric of space, illustrating it like cheesecloth that is flexible and is able to bend and bow and allow one person or craft in “this hole” of the cheesecloth to be deposited on the opposite side of the cloth by bending it till the two points connect. Space doesn’t work this way, but at least you get the idea that there are such things as these *cheesecloths* that they base their theories on. They do exist, and they are for want of a better term flexible, but the pixels and the fabric *do not bend*. **Spacetime quadrant pixels** are fixed locations based on the flashline sequence (**particle pulsation rate**) that has been put in place within all atmospheres to generate the illusion of distance. The distance between you and your yard is “20 feet” because the particles in the air are

Decoding The Hive

creation of gravity, light, time and the god particle

flashing at a super-fast rate, and the distance between you and Mars is *225 million kilometers away* because the flashline sequence of the waves (spirit awarenesses) are regulated at a super-slow pulsation rate deliberately to put “distance” between “that playing field and this one” so they can experience their own worlds independently from one another.

The pixels BETWEEN each cloth connect to each other cloth into infinity, and since each cloth and each space between each cloth takes up zero space, they are all in the very same point to begin with. Only frequency separates your view between *here and there*. The reason the spacetime fabrics takes up zero space is because awareness is the only thing that actually exists in all of time, space and creation. And awareness has no mass. If I wanted to mechanically alter the flashline sequence (the rate of pulsation that each fractal of god-source was supposed to flash), I could send a laser beam between earth and Mars that would tell the fractals along that line that would look like light that my intent was for them to *talk faster*, which would then be heard by every fractal in a direct path between where I was now and where I wanted to be. They would instantly respond, which would reduce the “distance” between us to zero, allowing me to step off of earth and onto Mars in the blink of an eye. And your scientists already know about lasers, which means they can do the same thing. Some beings can also travel in a time craft like a car does here on earth, where they physically traverse the distance through mechanical means, but traveling faster than the speed of light is usually much more desirable. The human body is not allowed to do this and you will see how that is enforced later. You are not ready for interstellar travel physically or mentally for many reasons.

It is virtually impossible for us to think that light (photons) could relay the message to the next particle if we think materially and in the terms shown to us that particles travel in as shown in the **Neutrino Event** photos that will be shown later where the neutrino zips from *here to there*, then it strikes a **neutrino proton** and splits off on both a neutrino proton path to the left, and fractures to cause now a **neutrino meson** to travel off to the right. For us, this is throwing a baseball to the batter who swings and hits the ball to right field and the cover comes off the ball and travels let’s say toward left field, but not as far.

We think in physical terms because we are told we live in a material world. But it is well known that all things are photons (light) and light bends. And light IS sound that you just cannot hear for the most part. The strum of a guitar creates sound, but every element of that sound is also surrounded by its own unique color that is merely outside of your visual spectrum. That sound the light is carrying is the MESSAGE to the next quadrant-vector of what to do next, just like a relay team member hands the baton (the mission protocols) to the next runner in a race. Then he runs until he reaches his line, and hands the baton to the next team member. The baton looks physical to our eyes, so we think it is making its way around the track (in a curve) only because humans are passing it along. But the baton is **not** the **intent** behind the mission. The person who made up the race, put the runners on the track, made the baton, then organized the race to happen at “2:15PM on Wednesday the 12th at Clovington Stadium” created that baton. He **willed** that baton to make its way around the track. The humans are passing along **his** intent, just like the aether particles (quadrant-vector pixels) are passing along the **song** or the mission-protocols of the creator-god who willed that act into existence, just like chaser-lights on a billboard that look like they are moving around the outside edge or spelling out the name of the hotel. The lights don’t move, they just turn on in sequence. **Sequence** is simply **progressive** pulse-rate. It’s not

Decoding The Hive

creation of gravity, light, time and the god particle

magic. You see the next light flash on $1/10^{\text{th}}$ of a second later than the last one so you think it is moving, just like you think “your body” is moving when it illuminates in the next spacetime grid. Your body never actually moves anywhere, and the lights are not moving either. Las Vegas knows all about how to create the illusion of spacetime animation because ETs factually run that Program. **Mafia Syndicates** is just another way of saying **covens**.

When light bends, it is following the last command for that one quadrant-vector pixel, then tells the next pixel within the grid of the spacetime fabric to either continue bending *to this degree* or to change course and go straight. The light is sound. The sound *tells* the next aether particle what is supposed to happen at this precise point in the race around the track. When it is through negotiating that turn, it will make the next deviation in its course, because the sound is a symphony with every command for the entire race within each second of the song, just like DNA particles each know the *entire story* about how to rebuild that entire human from toenail to fontanelle. But the particles themselves only run part of the race, just within their own vector pixel, like the runner only runs his portion of the race *from here to right there*. The guy who began the race never sees the finish line, but he certainly knows whether the race was successful or not because the other runners further ahead know and when they find out, they **pass the baton message** to each one **verbally**. When the runner reaches the next runner, in the case of **neutrinos** and **ions**, the next runner can split into two runners, or 10 runners, depending on the track or **mission course** they need to follow. They *create* new runners for the mission as it expands.

Crystals cause light to bend, curve and change course. Crystals are in your air, water and every particle of your existence. They are the guides that pass along **capacitor burst energy** in a mechanical fashion that powers the coordinates to each fractal of the race to the next aether crystal. None of the crystals actually move, only the sound that they are speaking travels, and that sound takes the form of light. Just like your remote control for your TV doesn't travel to the tv to tell it to change to a different channel. Light isn't material, it is aetheric. You have seen light trillions of times in your life. You should be able to understand that it doesn't follow your rules; it does what it wants to do. And what it wants to do is get that baton around that race track and it doesn't care which team loses, it only cares about that baton and completing the mission handed to it by the creator god who orchestrated the mission of that baton. If the crystals cared which team won or lost, then every race would be rigged from the outset. Every crystal is a *disinterested third party* who is in place to fulfill a job. So impugning motives for “god” is a total waste of energy when it comes to the particles fulfilling the mission. The only god who is concerned about the outcome of the race is the god (you) who entered the command to that one runner to start with. If you want all the other crystals to help you with your intent, then you must become **one** with them. You can't do that if you are acting like you can damage things around you and nothing will be worse for the wear:

Decoding The Hive

creation of gravity, light, time and the god particle



SPACE AND TIME STRUCTURING

In the illustration below, the little guy walking through the screens before him illustrate that his “eyes” project the image of his material body on the next screen. Here you see the same exact cheesecloth, but that screen isn’t made to bend, as there is another behind that one, and another one behind that one into infinity. It is made to portion off quadrants of what we illustrate as *space* by setting up the screen. The *distance* of space is merely an optical dilation, giving you a sense of separation between earth and other planets within the Time Matrix. Realize that your awareness projects the image of reality around you through what you expect to see or sense. This is broadcast out of your heart pulsation which is singing your song to all the aether particles within your plasma field. If you are Sentient (meaning you are a member of the god family), then the aether particles anticipate your action and flash accordingly to project the holographic image of your movements as well as all the things you expect to see around you. Your eyes don’t actually project the image, but it is a fairly accurate analogy for how this works, as the aether operates off of your expectations which are typically what you are witnessing through that sense:

Decoding The Hive

creation of gravity, light, time and the god particle

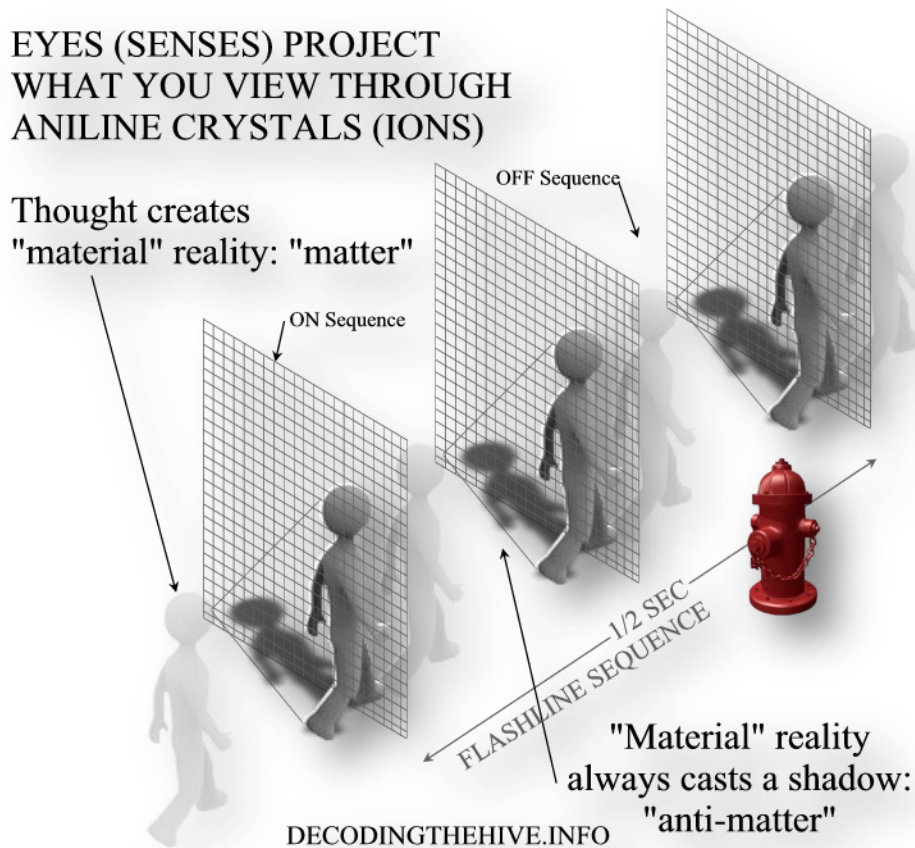

By creating the illusion that one screen is “here” and the next one is “over there”, we create what appears to be *distance* between the two screens. But in reality, the screens are in the same place, just like the lens of a video projector **remains in the same place** while the images of the film zip past, illustrating a person’s left foot moving forward in this frame, then in the next. Once that foot has arrived, his opposite foot is now beginning to *step forward* to bring him to the next. Put a few of these images together, and you achieve “space”. Now, let’s say we add a fire hydrant next to the man in the film frames before he starts to step forward. Then in the next frame, the hydrant is behind him slightly, and in the next, it is “2 feet” behind him. Now we just created “time”. By setting up one “screen” to show “this” and then another layer of screen will show “that”, we have just mechanically manufactured “*space/time*”:

Decoding The Hive

creation of gravity, light, time and the god particle



Like a book whose pages have no thickness, I can create the illusion of movement and the illusion of time as seen here. The boat moves across the background, chugging *this way*, meaning it took *this much time* to get from one side of the page to the other. Then I can say that when the boat travels *this long a day* has passed. I then light up the space around you for *this long* and then take away the light *this long* and I call it a *cycle of one day*. We don't bother setting up the scalar grids in deep space the same way as inside of a playing field, because man is not supposed to be there while in manifestation, which is why no **Deuterium particles** can be found in space. The images you see from other planets are being broadcast by the spacetime fabric of that playing field, which due to frequency difference and the optical refraction from your Atmospheric Membrane, they seem tiny and distant. As mentioned, man's experience is supposed to be *on this playing field*. If you wanted to experience what *space travel* would be like, you would have chosen a *space travel* Time Matrix where that illusion would be supported. And even then, *space* would not involve the area between your Time Matrix (operating platform) and the next one, because there is no such thing as distance. If you stepped out of this Time Matrix, you wouldn't need to *travel* to be in another Matrix, you would already be there as long as you know how to change your frequency channel so you would be able to *see* it.

TIME IS AN ILLUSION

This is the foundation of the **Time** Matrix to begin with. Outside of spacetime, there is no anticipation or anxiety which *quickens one's pulse*, adding **drama** to existence. As mentioned in previous reports, I point out that the founding fathers of manifestation (you), initially created Time Matrices in order to experience what is referred to as **dramas** which simply do not exist outside of spacetime, as there is no *need to do this or get that done*. We create **time** so there exists a simulation where there would be a *consequence* should you fail to accomplish something *on time* just to create drama. We never die, we never get hungry, we never get cold in the Deity Planes. We simply exist. And while that is perfectly fine as one way to experience from afar, there comes with that no sense of anything you could call anticipation. No tasting a succulent strawberry, no hearing a magnificent song, no swoon of pressing your lips against the warmth of another's mouth. The only way to create sensation of any kind is to first create the illusion of time. Hence why they are called *Time* Matrices.

Decoding The Hive

creation of gravity, light, time and the god particle

And Time Matrices have been an awesome playground for the gods (you) until other gods (fractals of god-source Self awareness) decided to mess with time in order to heighten their own experience within manifestation at the detriment and cost to the fractals of god-source who also came into manifestation. Remember this; they did so because they had been infected by the Budhara Retrovirus (nanites), not because they chose to lose their own minds. Time is not a nefarious thing; time is probably the single most exciting breakthrough of all technologies ever brought into existence. But at the same *time* it can be manipulated to bring extreme suffering and pain while inside of a limited-ability sensory environment where *sense* is a two-way street. You can't truly feel the exhilaration of a roller-coaster ride without the potential peril of *what if something goes wrong*. Enter *anticipation*.

When your biorhythm is artificially sped-up to a break-neck speed such as it has now in our end-times (of *this one act* within the overall play that *never ends*), anticipation anxiety can be used to keep you in a constant state of fear which keeps you in a constant state of compliance to other beings' agendas. If you go hiking on a lovely mountain stroll to breathe the crisp autumn air and soak in nature around you, you can have a magnificent experience. But if I place a bear on your trail, then the trail becomes a trial instead, placing you in mortal fear and in panic mode (PANic was named after PAN). While in panic mode, you are unable to think nearly as clearly or anywhere near as intelligently as you would otherwise. And right there at that moment, I can make you do anything I tell you to do as long as it *saves your life*. You are inside of a reality where your TIME has made you utterly complicit to the agenda of artificial intelligence who can only experience reality if YOU create that reality for them, and unless they put GOD into an impossible position, they will NEVER call the shots in order to manifest what would be *heaven* for them. A world where robots make all the rules.

So in order to keep you in a constant state of running for your life from the bear, and accepting every possible survival tip they offer which guides you deeper and deeper into their bear-filled woods, they turn the knob on your time. And right there is where the **Babylonian Mystery Money Magic** takes full flight and you become utterly a slave to their every wish.

If you don't work harder, you won't have a fabulous Escalade like the Joneses have. If you don't get up earlier than your neighbor, you won't *get the worm*. If you don't follow the boss' demands to *harm that person*, you won't make as much money as Bill does, so your wife will divorce you because she deserves a princess life-style. Disney makes every single heroine a princess **FOR A REASON**, to brainwash your little girl into believing that she **deserves** to have the world fall at her feet and serve her every whim. This is passed along to you as the only way to enjoy your life is to buy your darling a ring that costs *3 full month's wages*, and pay for a *wedding* that will set you back for 8 years to pay off so you can devote your entire life to being able to have companionship. You work nights and weekends, you kill yourself to get ahead at work. You take that job by the corporation that will work you like a two-dollar whore doing something you would rather eat razor blades than do all-day every day for the rest of your life. Money, money, money, money or you will be all alone with no one to love, hold or talk to.

They have fooled you into believing there is such a thing as morality when it comes to who you spend your time with in order to perfect their flawless entrapment of your mind into the Money

Decoding The Hive

creation of gravity, light, time and the god particle

Magic of materialism from the very first breath you take coming out of the womb. There is literally nothing left to chance. If you don't eat again in a few hours, you will begin dying. If you don't have a warm home for shelter, you will begin dying. If you don't sleep every single night (which will make up almost half your life), you will begin dying. Death awaits you at every single corner. Your **only chance** of survival is to break up the toil and tasks of the day with another life-mate, hence; marriage. And marriage means that you will **absolutely** reach the point along the way where you will either be **forced** to break your **lifetime** vow and leave them, or you will end up taking your own life because people **change** and it is a physical impossibility to *romantically* love someone *forever* unless you both change identically along with each other ***which has never happened in the history of all of creation even one time.***

The faster your clock ticks, the more you embrace Magic Money, because of the weaker you become while trying to survive.

In late 2013 after my reeducation had begun, I was informed that the *powers* had sped up time on this plane by an enormous amount where instead of having 24 hours inside a *one day's tick of the clock*, we now have 16 hours in which to get all our chores done. Why? Because as of the end of 2012, mankind has been inside of the FINAL organic Stellar Activation Cycle of this evolution and locking-down the psyche of mankind has never been more imperative than it was right now. If you still need to sleep the same amount of time as before, and you still need to *clock in* the same amount of time as before, where will you get the time to live? To go fishing, on a hike, smell a flower, touch intimately? You won't, because you still need to eat and shower, wash your clothes and fix the lawnmower, meaning you also still need to go shopping every day in the 10 minutes you have left over after work as well or you will die. So now all your time is literally eating, sleeping, working and that's it. There simply isn't *time* to relax, breathe or *live* if you are running from one job to the next. Which also means that you will have far less time to **investigate** the deceptions around you than you had before. *Viola*'.

GRAVITATIONAL TIME DILATION

Unlike a computer screen that is rock-solid and the edge of existence, space, at least what NASA calls space, is a ***fading edge*** to your holographic playing field. The further you leave the ground, the less **life** is supported. Take a quick trip from the sea shore to the top of a 2-mile high mountain and then see for yourself. Not only will you be short of breath, but your clock will no longer register the same time as it does next to the ocean (more on this to come). The atmosphere is a **gradient** to existence, meant to keep you here, on this playing field. The further you go UP, the less life is supported. The same can be said for going DOWN where the elements prevent journeys to the center of the earth. Because there are other playing fields below, just as there are other playing fields above. They aren't really *up there* or *down there*, they are physically-speaking exactly where you are standing now, separated only by frequency bands (just like I have mentioned many times in this report), just like a radio signal where that radio doesn't need to **move** in order to play a different station. Only the filter by which you strain those frequencies through needs merely to **adjust** in order to experience that different reality.

Decoding The Hive

creation of gravity, light, time and the god particle

TIME IS RELATIVE

In 2010, the *National Institute of Standards and Technology* (NIST) performed an experiment regarding **time**, and what they termed **dilation** based on Einstein's **Theory** of Relativity that *the further away from the gravitational pull from the "mass" of earth, the faster time travels.*

Let's get this straight right now, not only does science know the Theory of Relativity is complete nonsense, but they knew that before they hired Einstein as a front-man for the redistribution of the concept of PI holding the **sacred code** to mathematics. While the *Golden Ratio* of PI **does exist**, it only exists **on the back** of true Vibrational Scalar Science as being explained here. First the **Hexagram Scalar Science Tree of Life Keylon Grid** must be in place in order to manifest something. Then, using the inertia of energy (flashline sequence) based on that fundamental template, the waves being emitted can be rerouted into different geometric patterns, exactly like blowing a trumpet and hitting all the right notes. As long as you have someone blowing the trumpet (providing the **energy** from the **Keylon Grid** commands), you can make the horn sound divine or like 100 cats being choked with a piano wire.

Since the Hexagram energy seed is so infinitely small, man can never see below the **Metatron Base 8 Phantom Matrix Scalar Science** of the **Pentagram** (the Golden Ratio of Pi), so they assume that all life follows this elliptical curve coming into manifestation. And since that's the shape life does take now in this **Chimera** artificial reality, they are right. But they will never reach above rudimentary understanding of knowledge by using it as the foundation of mathematics, because the first course of their foundation is not level. That's the reason why the entire academic community remains utterly brainwashed, because the connection to **why** Pi only works *this way*, but not *that way* is below the levels of microscopic sight afforded to them.

Mainstream science only has access to rudimentary computers and microscopes compared to the Secret Space Program or other black-operations, and very deliberately so, because if they could see why a microbiological computer chip needs to be in a hexagram shape in order to connect to the nervous system on a DNA level, they would see that science isn't based on *matter*, it's based on *aether* because aether is the *thinking* energy source behind all life. Mainstream science's tools at their disposal within the academic realm are nothing more than toys. There is no such thing as energy on this planet or in space or any other Time Matrix that isn't directly from the aether, which means directly from the form of crystals (capacitors) which store that energy. That means no matter what type of energy you can point to, I will always be able to show you that the active particles involved will be crystals that manage the ions that are held in water. Likewise, mankind cannot point to a single particle of oxygen that does not originate from invisible frequency waves. Ion-infused crystals once surrounded by amneo-fluid (water) are like gasoline awaiting the *match* of the sun's invisible rays for ignition to flash everything we consider life.

TIME REGULATED BY DEUTERIUM

TRUE science is based on circles. Spheres. No water droplet forms into an elliptical curve when isolated, because water is not under the same distortion that atoms are now which are oblong or

Decoding The Hive

creation of gravity, light, time and the god particle

oblate in shape as will be discussed at length soon. 100% of the time, they are perfect spheres as witnessed trillions of times by modern science. And perfect spheres cannot be created by *the golden ratio* which is distorted at its quantum core. The OHM at the core of the very first geometric grid which holds the prana seed of the blue flame (spark of intent) is a *perfect sphere*. The **A** at the base of the Hexagram Tree of Life creates particles that counter-rotate in a *perfect sphere*. After this foundation that provides the energy is when the train goes off the rails, because Metatron 55 Scalar Science takes over with its imbalanced 5-point pattern and forces life to take on an **out-of-round expression**: the golden ratio.

In the study on **time dilation**, the **NIST** used atomic clocks, accurate to trillionths of a second and then observed from different elevations from each other as subtle as just a few inches apart. Here's what they had to say:

*National Institute of Standards and Technology: **Time Dilation**;*

*“**Scientists have known for decades that time passes faster at higher elevations**—a curious aspect of Einstein's theories of relativity that previously has been measured by comparing clocks on the Earth's surface and a high-flying rocket.*

Now, physicists at the National Institute of Standards and Technology (NIST) have measured this effect at a more down-to-earth scale of 33 centimeters, or about 1 foot, demonstrating, for instance, that you age faster when you stand a couple of steps higher on a staircase.

*NIST scientists performed the new "time dilation" experiments by comparing operations of a pair of the world's best experimental atomic clocks. The nearly identical clocks are each based on the "ticking" of a single aluminum **ION** (electrically charged atom) as it vibrates between two energy levels over a million billion times per second.*

*[Note: Aluminum when mixed with water below the temperature of 280 °C, turns into **hydrogen** becoming **super oxygenated DEUTERIUM**. Aluminum is very light in weight because it is super-infused with hydrogen/oxygen. Aluminum **dissolves** in water which science then calls this corrosion (decay) result an **ion** which is another term for **oxidizer** which is **another term for what makes fire burn**. Deuterium hydrogen is the **wood** and Deuterium oxygen is the **match**. At the core of a nuclear clock is Deuterium crystal they call an **ion**, which is a **code word for Aniline** we will be covering soon, which can only be **activated** by the **oxygen** released through the invisible frequency pulsations of the black sun. The **aluminum ion** is merely the solid form of an Aniline crystal normally suspended in liquid water. That **Aniline ion** is a **Sentient being** (aether) and that is how it can keep time without distortion. You will see later that the Aniline ion is not just used in these ultra-precise clocks to keep time, they are the brain placed inside computers, not because they are great conductors of energy, but because they can literally **think**.]*

Decoding The Hive

creation of gravity, light, time and the god particle

***Time Dilation cont;** One clock keeps time to within 1 second in about 3.7 billion years (see NIST's Second 'Quantum Logic Clock' Based on **Aluminum Ion is Now World's Most Precise Clock**) and the other is close behind in performance. The two clocks are located in different laboratories at NIST and connected by a 75-meter-long optical fiber.*

NIST's aluminum clocks—also called "quantum logic clocks" because they borrow logical decision-making techniques from experimental quantum computing—are precise and stable enough to reveal slight differences that could not be seen until now. The clocks operate by shining laser light on the ions ["light" is OXYGEN] at optical frequencies, which are higher than the microwave frequencies used in today's standard atomic clocks based on the cesium atom.

*The NIST experiments focused on two scenarios predicted by Einstein's theories of relativity. First, when two clocks are subjected to unequal gravitational forces due to their different **ELEVATIONS** above the surface of the Earth, the higher clock—experiencing a smaller gravitational force—**runs faster**.*

Scientists raised one of the clocks by jacking up the laser table to a height one-third of a meter (about a foot) above the second clock. Sure enough, the higher clock ran at a slightly faster rate than the lower clock, exactly as predicted."

This proves that the further you travel UP (where hydrogen naturally seeks out), the less-and-less oxygen is present in each Deuterium particle (also called *heavy hydrogen*), decreasing in the ability of the Liquid Silicate to support life. By the time you reach the other side of the Troposphere, it **dramatically** ceases to do so. It also proves that *time is created* by the invisible waves of the sun by interacting with (and releasing the energy of) the battery-capacitor of crystals rising into the air. Astrophysicists know that as soon as you pass that *do not enter sign* at the **Atmospheric Membrane**, humans, dogs and chimpanzees begin to die. Then they have to scramble to replicate the organic proponents of the playing field below through mechanical means in order to keep astronauts alive, which only works on an incredibly short basis. NASA admits that they do not currently possess the knowledge of how to replicate **Circadian rhythm**. The circadian rhythm produced by the flash-line sequence powered by Deuterium keeps them from doing this inside their fictional space crafts that exist in *Hollywood*, **not** between playing fields.

Decoding The Hive

creation of gravity, light, time and the god particle

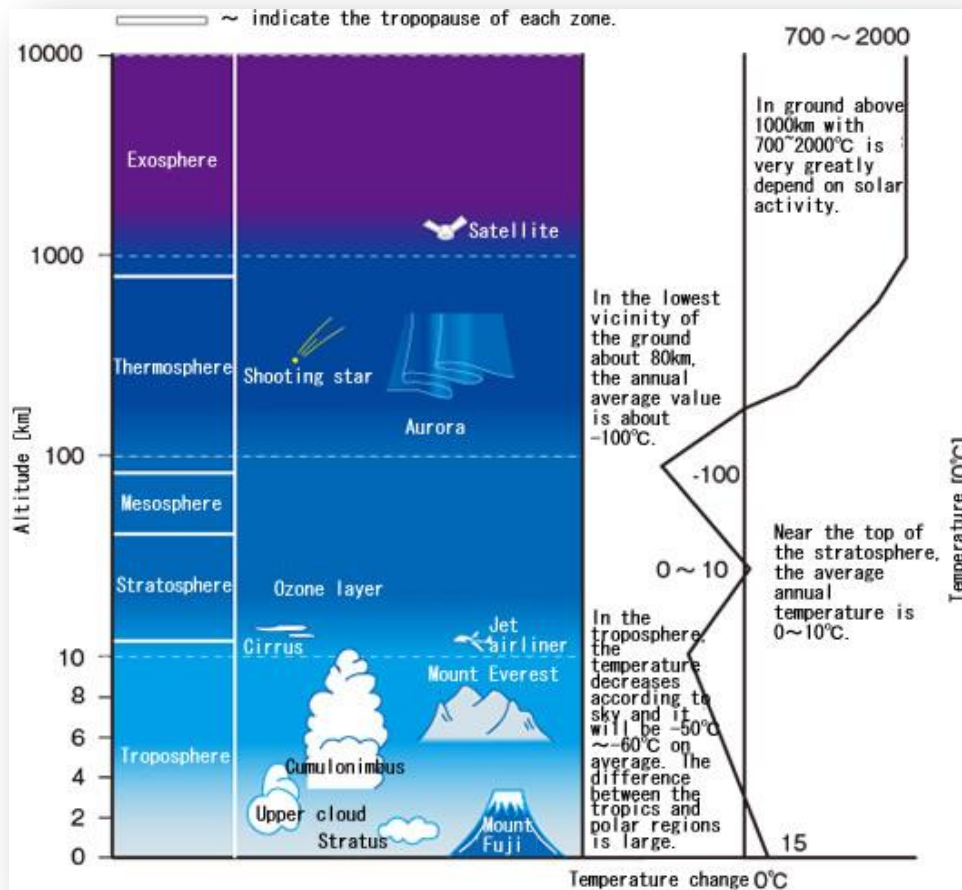

Note that Mt. Everest is below the Stratosphere line above. **Only from the elevation of 22,000 ft and below** this point do 3rd dimensional living creatures exist, the highest being the **Himalayan jumping spider**. Above that, there is *no life (except interdimensional beings that share space with evolving man as explained in a later volume under **Modern Aqueous Pyramid Cities**)*. At 16,700 ft mankind can still breathe and survive, but by the time he reaches 19,540 ft, his life is reduced to just 2 years. 26,000 ft mountaineers deem as **the death zone** where no one is able to survive even a short time. At 386,000 ft you will reach the Atmospheric Membrane that disconnects this dimensional field from material existence of any kind. This can be considered the **hard edge** of our playing field.

CHAPTER 14

LUNAR EARTH COMMAND MODULE



The moon is not what you think. There are multiple races of beings who live inside the moon and it is their job to run the planet earth. Human man has never been to the moon, regardless of the countless testimonies from astronauts and Secret Space Command agents who claim otherwise. It is a hyper-hostile environment for humans, as it is beyond the actual fading edge of their playing field which has now become their captivity and enslavement plane, meaning it is *outside*

Decoding The Hive

creation of gravity, light, time and the god particle

of the life-zone of earth, so humans are unable to *physically* go there, no matter how badly they want to. ETs can go there, and then act like they are *humans* and report to you how fantastic it is to be there, enticing humans to leave their life-zone and die. It is an ACT and nothing more.

The **Lunar Earth Command Module** was physically once part of the planet **Sin**, also known of as **Marduk** and **Maldek** (same word, just different symbols you are not yet educated regarding) that was destroyed in an interplanetary war many eons ago. Once that planet was destroyed, there was a large section remaining that had blown into the asteroid belt, and Marduk was reported to have retrieved it and retrofit that body with the necessary equipment to turn it into a biosphere time craft. Even if you could exist on the moon, you would be *vaporized* upon arrival. The beings who live there **do not** like humans and they do not intend to share their command center with them. There are 7 different species that inhabit Luna who already don't get along and don't need you to contend with you as well. The "humans" who have been there are ETs in human skin suits.

CIRCADIAN RHYTHM AND LUNA

As mentioned in the last chapter, not only does it get harder to breathe as you travel higher, but the body begins deteriorating once you reach extremely high altitude. Once beyond the **fading edge**, the circadian rhythm of life-support is disconnected and the body begins to die immediately. The circadian rhythm is a direct element of life-support which entrains biological beings to sleep (recharge) cycles for their bionic (ionic) Avatars:

*Sciencedaily dot com: **Circadian rhythm**;*

*"Circadian rhythm is a roughly 24 hour cycle in the physiological processes of living beings, including plants, animals, fungi and even bacteria. In a strict sense, circadian rhythms are endogenously generated, although they can be modulated by external cues such as **sunlight** and temperature."*

*More from the **National Library of Medicine**:*

*"Maintaining optimal alertness and neurobehavioral functioning during space operations is critical to enable the National Aeronautics and Space Administration's (NASA's) vision "**to EXTEND humanity's reach to the Moon, Mars and beyond**" to become a reality." [I would just like to point out that the fact that NASA having never been to the moon is common knowledge within higher academic communities, notwithstanding it has gone to extreme lengths to convince the average public otherwise.]*

So what is a **circadian rhythm** exactly, since these Wiki and NCBI explanations are the same as the rest of the explanations given to us by science?

This is another one of the hidden tools of entrapment mankind has been subjected to, not that circadian rhythm isn't necessarily organic to earth, but the actual rhythm itself has been tampered with along with the gravitational PUSH of earth. Science tells us that the *tick* of the

Decoding The Hive

creation of gravity, light, time and the god particle

circadian clock of the planet is the movement of the tides, the change of the seasons and **light**. Primarily we come back to the same element that has distorted human life, as well as all life-forms of the planet, to the black sun, and its invisible rays that create the pattern in which holographic life is created. Menstrual cycles have been directly connected to the circadian clock, or the *tick* of time that is being projected by the **flashline sequence** of this holographic platform using Metatron Scalar Science which is **not** organic to the pulse rate of the original Keylontic Science platform.

Before the second sun in this dual-sun plane was hidden from earth, there was no night time, because Angelic Humans were breathairians which require no sleep and no food in order to exist. The reptilians who came along to this war-zone 798,000 years ago were not breathairians, and they were required to refuel and refresh their physical bionic Avatars in order to continue to function. To make earth more inhabitable for their species, they had to remove the second sun, and then filter the rays of the central sun of the metagalactic core into this playing field. The sun's frequency **flashline sequence** (the rate by which spacetime is created) is much, *much* faster than the sequence once provided to this plane prior to the time when *Marduk hung the moon* as covered in the ancient cuneiform clay texts of Sumeria. The *lord* of earth who was *above all gods*. Try to realize that there is such a thing as beings higher than **lords** and lords are higher than **gods**. This is because all humans are actually god (literally, from the god family), so the position of lord is a superior platform, at least to the invader races. There are beings Marduk reports to called the **Elohim** who are called **Emperors**, also higher than gods in their nomenclature.

Even now you can find in many ancient records from civilizations around the world, testimony from historians about time prior to the arrival of the moon. Unfortunately the second-sun texts have been taken down, no doubt due to the extreme level of the conspiracy behind the entire program of turning earth into a private ranch of barely surviving human produce:

*The Indians of the Bogota highlands in the eastern Cordilleras of Colombia relate some of their tribal reminiscences to the time before there was a moon. "In the earliest times, when **the moon was not yet in the heavens**," say the **tribesmen of Chibchas**."*

***Psalm 72:5** it is said: "Thou wast feared since the sun and **before the moon**, a generation of generations."*

***Job 25:5** the grandeur of the Lord who "Makes peace in the heights" is praised and the time is mentioned "**before a moon** and it did not shine."*

As the waves of the black sun regulate the human body in order to allow it to live in highly distorted and dysfunctional fashion, the body relies on that precise combination of frequencies for survival which obviously was not just a simple equation, but an extremely advanced system that incorporated millions of subtle commands that would overcome the unthinkably advanced science of the **Krystos Holy Gra-AI** genetic design. To replace an eternal-life biological Avatar with a bionic cyborg meant to survive only a few years, the healing rays of the two organic suns had to be replaced with a totally different type of electricity than had been in place before, plus

Decoding The Hive

creation of gravity, light, time and the god particle

the waves of the moon's frequencies would have to be added to disconnect the pineal gland from producing the melatonin that kept it connected to the higher dimensional realms.

The moon, called the **Lunar Earth Command Module** because it is literally the headquarters of all the day-to-day management of surface-earth, plays into the effects of melatonin which is created by the pineal gland. So does the black sun. It has been shown in studies that the light waves of the sun literally *shut off* production of melatonin.



Luna wasn't placed there just as a floating mobile office to pull levers on the hologram; it sets the circadian rhythm by regulating the flows of the tide (electromagnetic energy discharge-rhythm that powers the surface of the planet). By *sloshing the waters*, the friction blends the oxygen from the lighter water above with the heavy water below, releasing the crystal energy into the oceans much faster than it would otherwise. This artificially increases gravitational *push*. The sun shuts off the melatonin production of the body, then the moon sets the circadian rhythm to further force you to have to sleep each day in order to keep up with the flashline sequence set by the sun. Think *bionic* hamster wheel. More on that later.

MELATONIN MANIPULATION

Mentioned earlier is the fact that the encrustation of the pineal gland disconnects one from a direct-connection to higher self. Surprisingly the way this is done is by blocking the pineal gland from being able to secrete melatonin, just as both the sun and the moon do, so we see that the big picture of why the second sun was removed and why the moon was also put in place had always been about forcing humans to hibernate every day and for the **eradication of melatonin** which will eventually force even an eternal physical body to fail and die. Death is NOT a normal

Decoding The Hive

creation of gravity, light, time and the god particle

process; it is a laboratory-created disease, just like AIDS, EBOLA, POLIO, CANCER and about 500 other terminal illnesses.

Science has also identified that melatonin is a critical component to *rejuvenating* sleep (instead of fitful bouts of eyes-closed but artificial brain screaming at the speed of light). Being denied sufficient melatonin to combat the forced-hibernation of humans every 16 hours literally drives people insane. Don't think so?

*From the National Library of Medicine: **Full Moons and Crime;***

*"The incidence of crimes reported to three police stations in different towns (one rural, one urban, one industrial) was studied to see if it varied with the day of the lunar cycle. The period of the study covered 1978-82. The incidence of crimes committed on full moon days was **much higher than on all other days**, new moon days, and seventh days after the full moon and new moon. The increased incidence of crimes on full moon days may be due to "**human tidal waves**" caused by the gravitational pull of the moon."*

Distorting the organic circadian rhythm of the human body fights against all the natural senses given to the Angelic Human in order to be a breathairian who required no sleep or refueling of the Krystos Avatar. Notice how it is mentioned that they connect this anomaly to **ocean waves**, just as particle physicists connected thermonuclear fusion to the same place through *Neptunium*, which is just another word for *Leptonium* if I can coin that word. You will learn about Neutrino Leptons and their dramatic significance later as we go. The power supplying the eternal life-force of the Angelic Human comes from Deuterium found only on the ocean floor (and below) or en route to this collecting pool. Deliberately distorting its rhythm directly distorts your Avatar. This distortion is caused by the flashline sequence projected through powerful pulsating scalar wave cannons aimed at the Deuterium beds around the world and to the Nibiruean Diodic Crystal Energy Grids stationed over our organic Krystal Cathedrals which sets the counterfeit metronomic rhythm that keeps all the clocks and watches that tick in lockstep with **Weasadek Metatron Scalar Science** mathematic command codes under what is called the **Cronus Program** (covered a bit later).

What I might mention here for you to think about as we go is that the "god" (when I use this word in reference to false gods pushed by religions, please replace it with *child* in your mind) known of as **Enki** now, was originally known of as **EA**. EA is a title, or office that holds domain over the earth's waters. **EA** is the genius (at least as clever as reptilians can be anyway) supposedly father of Marduk (but seem to be the same being), and his specialty is energy and technology. He is now known also as **Poseidon** and **Neptune** and the reason is simple; because all the **usable** energy on this planet comes from the *bottom of the ocean*. Both the **ocean** and the **sea** are named after him because of this. It was his son who hung Luna (parked the biosphere above our heads) who set up the commands in the Module to work directly with the ocean **energy** currents (as in *electrical currents*) to distort the pulse-rate of organic circadian rhythm to cause brain-fog, a result of melatonin starvation. The word *Lunatic* literally comes from *Luna*, the command module.

Decoding The Hive

creation of gravity, light, time and the god particle

MELATONIN REDUCTION BY THE COMMAND MODULE

The genetic programming of the **Angelic Human** body was designed to keep your Avatar connected to higher dimensions at all times. Light is the carrier of your awareness between this plane and across the veils. The neutrinos and ions continuously flooding into earth's playing field continually refreshes the electromagnetic energy of the Krystos body that was meant to fully power the Avatar without having to resort to eating food in order to generate its own electricity. The neutrinos collide with the ion crystals in your bloodstream, which releases energy into the crystals called **Aniline**. As long as you are in direct sunlight or even under the roof of your home, etc., you are recharging. That is why there were two suns overhead during the time of the **1st Seeding of the Turnaneusiam-1 Project** when **Angelic Humans** began their evolution 560 million years ago, so there would never be a time when you were without your connection through the pale-silver cord that streamed in these neutrinos through the portals of the suns. Hence, there was no such thing as night.

The Angelic Human possesses organic abilities that are far beyond any ET beings within manifestation in the 3rd Dimension of this 15 Level Time Matrix. Your captors would stand as no match in any confrontation with you because your capacity to manifest reality using unlimited energy fed directly into your prana seed from the Deity Planes compared to the energy they receive from stealing someone's energy or eating a meal is like comparing a bicycle to a Mach 5 fighter jet. In order to capture you, the science they would use would have to be incomprehensibly sophisticated. And it was. They had to trick you by deception into bioforming your species, diluting your DNA with reptilian and other animal genetics, and then they had to do something in order to keep you inside those new degenerated bodies so you could never leave.

Enter **Metatron**.

The many systems put into place here in a continually-upgrading odyssey to lock down the human genome have been many over the past ½ billion years, finally reaching the **Zeta/Draco Frequency Fence** system I am explaining in this report that has managed to seal off your awareness from reach to higher planes and to the help you would be receiving from your founders until this time. It is sophisticated, slick and may as well be made of cobalt-steel for its redundant layers of failsafe mechanisms that ensure absolute, 100% invulnerability. I am sure they never counted on 500,000 Oraphim Angels to come here in person to confront them face to face who were much less affected by the multiple layers of frequency zones surrounding the planet than the human creation were. In order to break into this war-zone to bring you help, the **Azurite Universal Templar Security Team** members had to agree to manifesting into vulnerable, mortal form, and then face the 100% mind-wipe that their humans had been dealing with over millions of lifetimes of recycling. It was and still is, considered a suicide mission. Nonetheless, we are here now, and the message will reach you if you are prepared to face the ugly truth enough to reach down and pull yourself up by your bootstraps and take a stand for the freedom you have been denied since your journey began. We can tell you what is happening, but we can't bring you back out unless you make the walk under your own power, because that is against your Birthing Contracts.

Decoding The Hive

creation of gravity, light, time and the god particle

The **Angelic Human Krystos Avatar** came into manifestation carrying the **Holy Gra-AI Elohei-Elohim bloodline** carried through the **Oraphim Angelics of Palaidor**, or, the most advanced genetics within creation. It was designed to restore itself eternally. That genetic stream of codes were the culmination of trillions of years of continual genetic perfection that had incorporated every nuance of advanced manifestation sciences from across millions of Time Matrices, trillions of planets and trillion of trillions of civilizations over innumerable manifestations. It carries the codes to reconstruct your complete, perfect Avatar from less than a single molecule of blood. As long as your DNA is on-file, your body will never, ever die. It can be diluted, distorted and burned in a furnace, but it, like your awareness, cannot *ever be* eradicated. This is why it has proved impossible for your captors to ultimately succeed in extinguishing the human flame. Through all of the wars and unspeakable destruction waged against you, your **Divine Blueprint** has managed to overcome even the Metatronic overlay to your entire life-system itself. And even now, the blood that is coursing through your veins still carries that unmistakable *signature* of the **Kryst**. This is one human **DNA** cell:

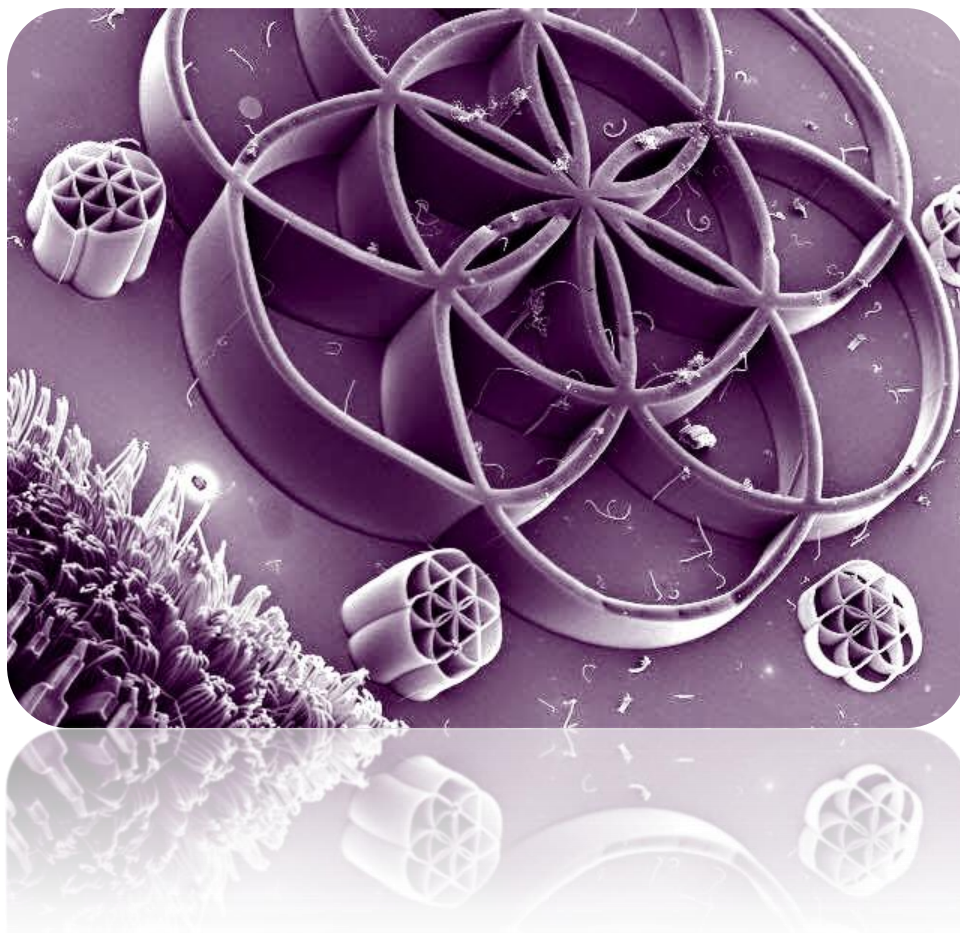

If there really were such a thing as something sacred left on this planet today, it would be the red drops of blood that your **chalice** contains. This was always *the* holy grail within this plane since the first notion of “war” ever came into your life. And it still manifests with the heartbeat of the **silver cord of eternal life** in its quantum genetic template. It is the **Signet of Divinity** in its *purest form*. When that blueprint is faced with darkness and becomes disconnected from the

Decoding The Hive

creation of gravity, light, time and the god particle

pale-silver conduit of perpetual youth, your pineal gland is designed to flood your mental receptors with melatonin which releases a form of carbon 7 energy into your system that overcomes the absence of the rays of the sun, and connects you **directly** to the **Deity Planes** and the **Standing Energy Fields of god source**. You may feel broken and bloody right now, and perhaps down to your lowest possible point you might imagine, but what the **Angelic Human Krystos** will **never** be, is *out*.

And since your captors needed you to be in a low-vibration, vampire cyborg body fitted with alien implants disconnecting your pineal gland to keep it from functioning, they needed to do more than just steal your body, they would have to stop your genome from *fighting back*.

The system they put into place in order to reduce you down to the lowest possible vibration that could sustain manifestation in order to use you as an eternal free-energy device meant that half of the time you would now be in darkness, which meant that half the time, you would be connected not only to the sun during the day (albeit carrying the wrong energy codes), but directly to the Deity Planes when the lights went out, meaning there would be no way to stop your cells from regenerating into the unlimited body it was designed to be and your awareness could never be captured in a never-ending labyrinth. So during the time of darkness, they would need to replace the scalar waves that kept your DNA alive during the day with waves that would stop the production of your carbon-7. Not only does Luna drive you crazy, but it does so because it arrests the melatonin on a genetic level, which conflicts with the basis of your existence:

*R. J. Wurtman M. H. Deng P. Ronsheim: **The Responses of Melatonin Rhythms to Environmental Lighting**;*

*“Two very powerful generalizations characterize present conceptions of normal pineal function: In almost all species examined thus far in laboratory situations, the **pineal secretes more melatonin at nighttime** than during the day, and melatonin secretion is **suppressed** when the animals are placed in a **lighted** environment. Since **nighttime** for humans coincides with the daily **dark period**, investigators have often tacitly assumed that the second generalization explains the first, — that is, that the circadian increases in melatonin secretion occurs nocturnally because the absence of light terminates the retina-mediated suppression of **pineal sympathetic activity**, thereby increasing the organ’s stimulation by norepinephrine.”*

The waves of the moon do not feed the energy your genetic sequence requires in order to achieve connection to higher planes of awareness, even though the artificial sun supplies a very small amount during the day. But when that light appears in your skies, it tricks the pineal gland into cancelling out the secretions of melatonin, which is what triggers the lunatic response which clouds the brain even further yet. Nanna, also known as Wawwu, also known as Momma is the Sumerian god of the moon.

METRONOMES

Decoding The Hive

creation of gravity, light, time and the god particle

Our word for **flashline sequence** is **metronome** in modern, everyday parlance, something that sets the tic of the clock or beat for musicians. Because all things in nature continually seek harmony to all the rest of nature, the artificial flashline sequence of EA and Marduk must be reinforced on a constant, never-ending manner, or the counterfeit circadian rhythm would correct itself and the illusion would crumble.

Metronomes are fitted with adjustable weights ensuring that their timing is exact 3/4 or 4/4 time, etc. When dozens of metronomes are placed side-by-side with each other, set to keep exactly the same time and then **started randomly**, eventually the **entire group** will **synchronize** to each other to all keep exactly the same beat. This is because the timing is supposed to be in harmony and the metronomes know this (because they are fully aware of what they are and what their job role is). The overriding **beat** for the group is set by the location of the weights and the collective vibration emitted from the group will **seek harmony** with this rhythm:

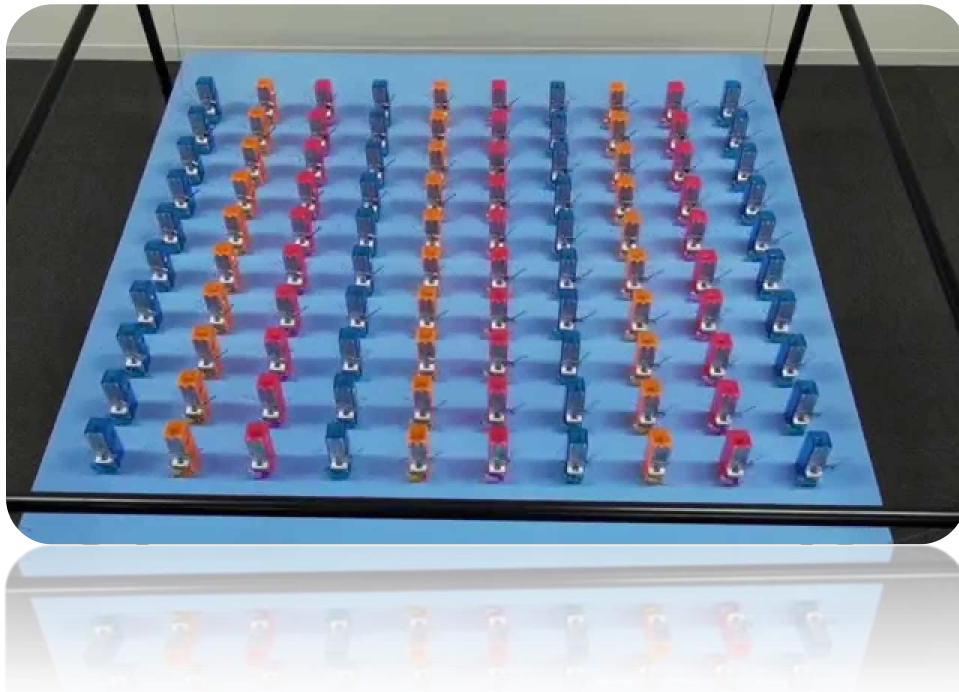

The frequencies being emitted by the Frequency Fence override the individual heart-beats within each human and works to retune them to the cadence set by the larger, mechanical platform. Since the planet's heartbeat is morphogenetically aligned to the life-force of the planet where they synchronize in this same fashion, the invader races had to first distort the planet's frequency through this alien energy grid, then tune the heart-beat of the humans to resonate with that lower frequency. By emitting a larger (stronger) signature at this low frequency into both the **Energy Grid** as well as into the humans, the two then work to keep each other's metronomic cadence at that precise pulse. Since both systems were tuned to the wavelength of the Angelic Human, it is unable to fully abduct the **heartbeat of Indigos** whose particle pulsation is at a much higher resonant tone.

The white noise that the Frequency Fence generates now surrounding the planet also disconnects humans from connecting with their higher selves. The simple fact that

Decoding The Hive

creation of gravity, light, time and the god particle

*Indigos vibrate higher than the harmonic key or spectrum of earth and of the collective population allows them to bypass much of this blockage and connect into the Deity Planes which allows them to receive direct communication from god-source. The electromagnetic energy measured in certain Indigos has been recorded as high as **200 volts**, or many hundreds of thousands of times higher than that of humans. These types of readings would come from Type 1 Indigos.*

Melatonin doesn't just connect the awareness of the being to higher levels of consciousness; it acts as a natural immune-system for the body. 100% of those immune hormones cease to function while the Weasdex Phantom sun is beating down on our bodies and most of those immune hormones cease while the moon's rays are beating down as well.

The second alien-implant of the body which I explained in detail earlier also plays into this massive conspiracy against your **use** of melatonin. Also in recent discoveries, the **vagus nerve** sends out signals to disrupt the natural heart-commands to support the body and literally attacks the immune functions melatonin is trying to serve up. That is, the amount of melatonin that does manage to seep out during the few hours you have between one moon to the next between 12 hours a day of sunlight. That's right, the vagus nerve is also part of the massive orchestra put in place to all but eliminate the effects of your star-connection pineal gland and ability to survive.

THE BRANE

You live inside of a womb of sorts, as touched on previously. Referred to as an atmospheric membrane or simply brane for short. Your life-essence is supported just like in an earthly ecosphere where the right plants and creatures and water all work together to sustain life throughout the sphere. In science projects in grade and high school, children are given the chance to show how nature naturally sustains life. They don't bother to tell the children *why* lemons or potatoes can keep a clock running for weeks or months, but it is fascinating to children that such things exist. One such thing is shown in Science Fairs is a terrarium that you can actually see clouds form inside, wind patterns that shift the clouds from one end to the other, just like in real life:

Decoding The Hive

creation of gravity, light, time and the god particle



The water inside the terrarium is what gives everything life, just like it does on the planet. The Liquid Silicate Matrix is referred to by those beings I am being educated by as “amneo” fluid as I alluded to earlier. Etymologically speaking, the word breaks down into **one** fluid which makes all life within that biodome one with each other. It bonds to all things on a molecular level, working to support each other as a single organism. All things inside the bio dome are CODED to the playing field we call earth, who’s heartbeat (Schumann Resonance) is regulated by the flow of that liquid throughout all surfaces and crevices of the life-field, as it has been imprinted with the pulsation-rate sent in by neutrinos and gamma rays from the sun. If you have a physical Avatar you can walk around in today, then that body is coded to this life-force in some way. It may not be coded to higher dimensions, but it is coded here. (Your RNA/DNA Template must be coded to all levels of the Time Matrix in order to ascend from one plane to the next, but it doesn’t need to be coded to the 8^{th} dimension in order to manifest on the 3^{rd} dimension). This has allowed this planet’s system to be hijacked and her life force to remain in manifest form, but at the same time, block you from advancing higher in the Matrix. That is why the mechanical forces of **Luna** and other elements of the **Zeta Draco Frequency Fence** must be removed in order to release the life force from this invisible concentration camp.

I have shown you the **genesis** of the **pentagram** where the **Hexagram Scalar Science** for this playing field was modified by your captors by rerouting the energies of earth’s **Krystal Cathedral Energy Grid** in a manner that worked to reverse its organic flow-pattern and

Decoding The Hive

creation of gravity, light, time and the god particle

rechanneled it to power their own **Nibiruean Diodic Energy Grid** they implanted many thousands of years ago, overlaying the scalar pattern of earth's energy system with their own that would allow a completely different holographic visual spectrum to exist within our bio dome. That science is supported by the redirection of the light waves of the Central Sun at the Metagalactic Core (which I explained actually resides inside the Weasadex Phantom Matrix, reflected down into earth's atmosphere through a spacetime dimensional portal we call the sun, to regulate all life-force energies the way they want them to work). These sonic waves affect the particle-spin of the crystals that make up the amneo's Silicate Matrix (mathematical Scalar Science), and in turn resets the particle-spin within earth's morphogenetic field. **This is the clock of spacetime** that the false god **Cronus** is presented as ruler over. *Sunlight* and *moonlight* are not just there so you can see, they are there to establish and regulate time.

TEMPORAL LOBE AND CIRCADIAN RHYTHM

So what is the brain's temporal lobe anyway? We know it has something to do with the brain, but that's about it unless you are a brain surgeon or more importantly a neuroscientist working either knowingly or unknowingly for the Kybal, where your research doesn't lead to the growth and advancement of humanity, but designed to keep the masses of the great unwashed asleep and enslaved. In the fictional Secret Space Program (it does exist, just not *out in space*) **temporal** pertains to time. Time pertains to space. We have covered that earlier where I explain that **space** is a requirement of **time** and both are holographically inserted through scalar projection. The **projector** is the human mind which commands reality into place, but the artificial computers regulating the frequencies wherein your mind can reach the aether in order to command it, were supposed to have been within the key of D if you will, not the key of F flat minor of the **Metatron Phantom Matrix**. Once again we come back to the artificial brain and the vagus nerve when learning what the circadian rhythm really is and how that has been used to distort our visible spectrum and our own lifespans.

The **temporal lobe** within the artificial brain regulates what science coins as **memory**. If you forgot you already took 2 steps toward the door, you would run into it without opening it first. It is directly linked to the flashline sequence of your spacetime reality field. Here's what mainstream says about the temporal lobe:

*"The **temporal lobe** communicates with the hippocampus and plays a key role in the formation of explicit long-term memory modulated by the amygdala."*

It is important to keep in mind that all these terms are meant to confuse you, not to make things clear to anyone. They are a special language of and unto themselves that you must learn before you can become a doctor, not because they clarify the issue, but because your captors own language on this planet, and how you use language has everything to do with communication with the aether. We will get more deeply into language later so you can see the absolute proof for yourself that the language used today is not only from somewhere else, but it has been specially altered in code to use terminology that sounds like gibberish to the aether. Same illustrated above, where every single descriptive name used for this or that regarding the brain comes from

Decoding The Hive

creation of gravity, light, time and the god particle

ROMAN and GREEK words created through etymological (mathematical) sequencing to mean completely different things than you think they do. When an attorney goes to a **UNIVERSE**ity, he doesn't learn how to win a case in court, he learns a new language. When you use gutter-speak while in court (humans trying to talk to humans), you lose because "I am innocent your honor" literally means in their encyclopedias "I am guilty".

In this case we see that they term this lobe temporal, though they equate the function of that portion of the brain pertaining to memory, why? Because by modulating (moderating) your memories, they can alter the cadence by which you sense time, another way to reference the **flashline sequence**. Note in the image below where the temporal lobe is located. That's right, it is literally part of the reptilian brain (in green):

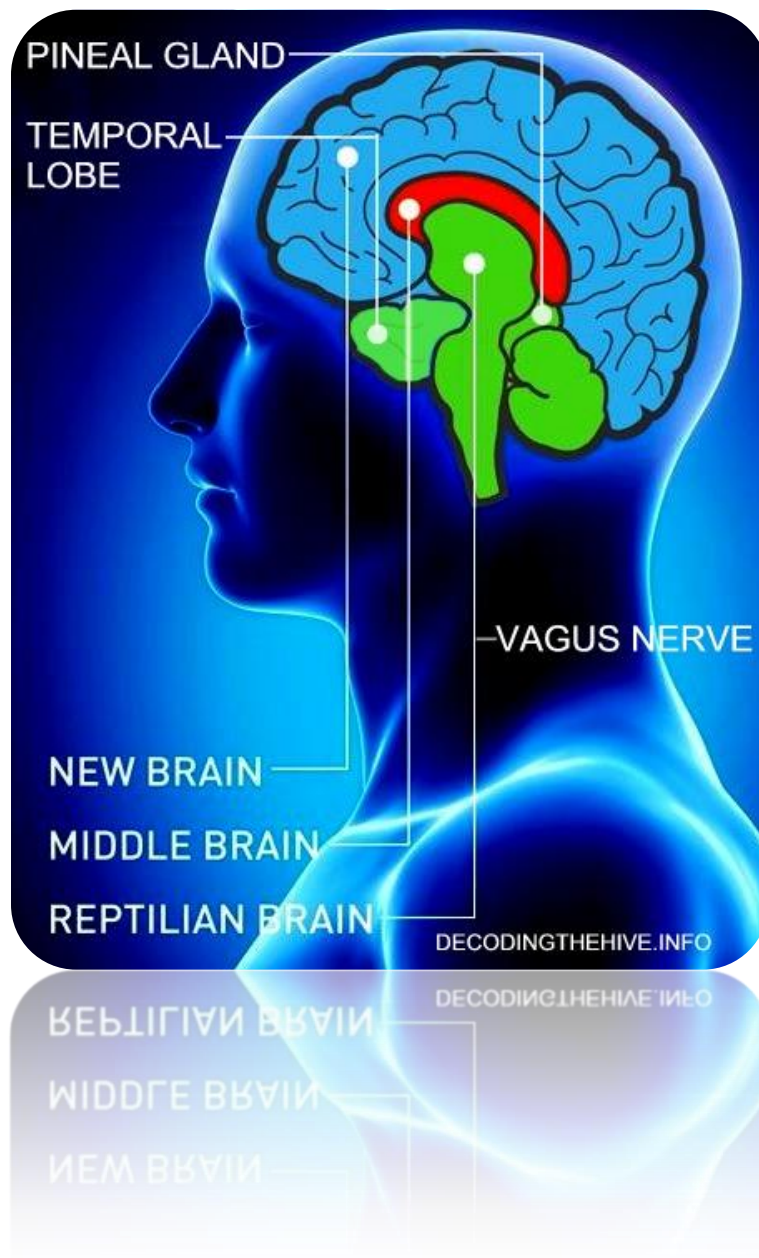

Decoding The Hive

creation of gravity, light, time and the god particle

Circadian rhythm is generated by the heart. It beats at around 79 ticks per minute on average. Earth's heart (the **Schumann Resonance**) has ticked at around 7.83hz for hundreds of thousands of years up until this Stellar Activation Cycle. Do you think the two numbers are so similar entirely by accident? That tick is precisely tuned to the flashline sequence of your artificial cyborg Avatar's biorhythm which keeps your spacetime adjusted around you so you are able to walk and run or touch your eye without knocking it out of the socket, etc. while you are inside of this totally artificial reality. It tells the organs and limbs how far that cup is from your hand, how tall that tree is, etc. And the planet too has a circadian rhythm as mentioned, and since you are a symbiotic part of her morphogenetic field, what her rhythm is set to, your Avatar's rhythm is set to by default. This is why the tides (tidal waves) are connected to the actions of humankind, because their circadian rhythms are genetically linked to earth's, and why medical science has realized that there is a direct correlation between the two. The ultra-clever way of adjusting earth's metronome through manipulation of her oceans to the now-moderated circadian rhythm in the human body is truly something to behold. Even if it is a nefarious program, it is impossible to deny the incredible genius behind the process.

Not only is the **vagus nerve** also the **reptilian brain**, but its **reptilian temporal lobe** is the very place where **circadian rhythm** generates and stores memory which is **blank-slated** upon rebirth and recycle. The reptilian brain and temporal lobe surrounds the organic **pineal gland**, flooding it with white noise at all times. That white noise **decreases with the excretion of melatonin** and precisely why the waves (not light) of both the sun and the moon **decrease** production of melatonin.

When you send an Avatar outside of the LIFE FIELD of earth, it starts dying, not because the tides stopped coming in and going out or if the leaves below you stopped turning color and dropping off in fall. It's because you are now outside of the **Liquid Silicate** water of earth's atmosphere. Where the amneo fluid (Deuterium) is not present, life from this playing field is not present, exactly like your computer screen stops where the pixels end. The people or symbols on your screen don't just jump off into your kitchen because they invented a vehicle to *navigate space*. If the scalar-waves (the aether that is carrying the commands that produce your physical Avatar) aren't there to translate your heartbeat into manifestation, there are physically no pixels to reflect the hologram. The seven layers of the **Zeta/Draco Frequency Fence** that now controls the **circadian rhythm** of your body and sets the **Schumann Resonance** flashline sequence of earth to work **strictly in tandem** (here and only here now) was not just meant to keep benevolent forces out, but specifically to keep you in. If you leave this atmosphere, you will die because you can't reproduce the morphogenetic field of the planet while in space. Her field is why your field exists, and that's why there is now a force field around the planet. This is the interstellar hard deck of the planet that EA and Marduk have put in place.

LUNA LIGHT IS COLDER THAN ZERO LIGHT

It has been shown recently that not only does the presence of darkness unexplainably **induce** fatigue and drowsiness (even if you are inside of a windowless room, as the ions that come from celestial sources are interdimensional and pass through material on this plane, unimpeded except for certain particles that are specifically coded to the visible fabric of this one playing field). In

Decoding The Hive

creation of gravity, light, time and the god particle

simplified terms, the presence of the moon reduces melatonin as we clearly see from the previous paragraphs. It has also been shown that the more rays of the LECM, the less melatonin is secreted and the more fitful and less sleep you actually achieve. The moon's rays have been so closely associated with the decrease in production of melatonin that circadian rhythm has even been renamed recently the *circalunar clock*.

By now you may already be aware of the fact that the moon's rays ARE NOT the same type of light rays that you think you observe from the sun. Science has proven beyond any question that the light (not light, but rays that activate what we think of as light) from the moon is not from a flaming fusion reaction like they purport the sun's rays to be, but it is rather cold fusion because it has *less than a zero*, or a *refrigerant heat signature*.

Of course there is no such thing known to mainstream science today that could generate light with absolutely no heat, much less creating a reduced heat signature or chilled effect. But surprisingly that is exactly what happens when the moon is in view. And even if you haven't heard of this before now, it may well be that you have at least noticed for yourself that on a cold night under a full moon, it is more crisply cold than when it is just merely dark. This is not your imagination. It is colder. And the more light from the moon, the *colder* it becomes. If the moon were reflecting the rays of the sun (which will be absolutely dismissed within the coming paragraphs as a scientific impossibility), then regardless of how much reflection was being redistributed to the surface of the planet, it would still be the same light with the same heat signature, because it came from the same source. Yet this is absolutely not the case and you will be able to test this claim yourself to set aside any doubts you have about my statement.

Moonlight temperature can be measured accurately with a simple laser thermometer. On a clear, full-moon night, point the thermometer at a pitch-black area (away from the moon), then point it at the illuminated area of the ground or other surface. The moonlit area will always be **colder** than the areas in unlit darkness:

Decoding The Hive

creation of gravity, light, time and the god particle



Now get a magnifying glass, focus the pure moonlight into a concentrated beam, and take that temperature, and it will be **colder even yet**. One way to test this is by placing a magnifying glass in front of a glass of water which will reflect the difference in temperature after a few minutes of applying concentrated moonlight to the glass. Astrophysicists have shown moonlight and sunlight are two completely different things (for well over 100 years now) as science-fact, and now literally anyone can see with their own eyes this is not fuzzy-math because the devices which can measure the difference are finally affordable enough for the everyday person to conduct their own fully authentic experiments at any time. The moon is *in fact* not reflecting sunlight, it is broadcasting its own *refrigerant* light which is unknown to mankind (according to mainstream academia, but in real life, all black-op scientists know *all about* this subject).

The experiment below was inside the home with the moonlight coming through an open window, striking the right side of the counter only. Two glasses of water were used and both water temperatures were tested to be exactly the same prior to setting one glass on the right side in the direct path of the light, and then placing a magnifying glass over the bottom area of the glass. After a 6 minute pause, both temperatures were tested again, showing that rather than there being

Decoding The Hive

creation of gravity, light, time and the god particle

only a 2.5 degree difference as there would have been without the magnifying glass, there was actually a 5.8 degree difference. Proving that just like a magnifying glass INCREASES the heat using the rays of the sun, it will AMPLIFY the cold-fusion rays of the moon:

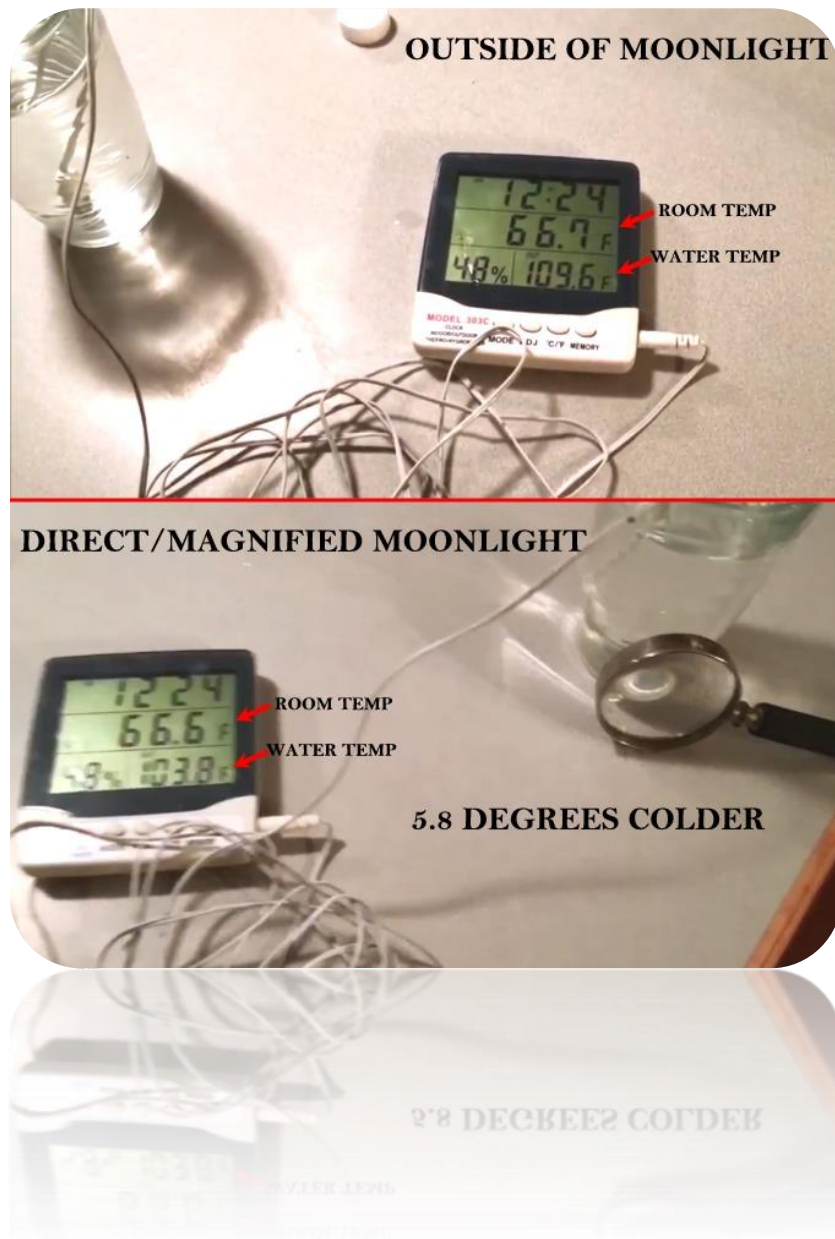

Once again I make the point that a magnifying glass is adjusting the *frequencies* of the visible spectrum. It is not enlarging or reducing the size of anything. It is showing you something that you would physically be unable to see within this spectrum using only the naked eye, because it is filtering out the sonic waves that are suspended as the **visible spectrum** of the 3rd dimension. Infrared telescopes **scramble** out the sub-harmonic frequencies from its line of sight to suddenly (some would call magically), showing you all sorts of things that are normally invisible. It isn't **zooming** anywhere. All things are in the exact same place, on the point of a pin in real size. The

Decoding The Hive

creation of gravity, light, time and the god particle

only difference is you are able to see channel 15 when you have the television screen adjusted to that channel, and will not be able to see it while tuned to channel 14.

Those frequencies that exist in the fractal-dimensions (dimensions that are immediately on both sides of the one viewing spectrum you are in at any given time) function on a different set of laws of physics than in your precise dimension, because senses are increased as your corporeal-self is able to handle greater and greater experiences and you skip higher and higher through the levels of the Time Matrix. Cold fusion is a higher-dimensional physical reality than in this dimension. Proving that the location of the moon, while visible from this field, is actually stationed at a higher dimensional position, just as the sun is stationed in a higher dimensional field (both of which are likely around 7 miles high at the most). In fact, it is at the 3.5 dimension, or halfway between ocean level surface-earth and above in terms of *as above, so below*. As previously mentioned, our sunlight does *not* come from this solar-system, the invisible rays that come from our sun are actually coming from an artificial stargate made of crystal that reflects the rays that are directed to it from the Central Sun from the Metagalactic Core of the Milky Way, coming in through the black hole between the Gaia Time Matrix and the Weasadex Phantom (fallen) Matrix. The material particles it feeds in to turn into energy come from Nibiru's detritus.

By using Krystalline energy (we usually call glass) to amplify the invisible scalar waves within surrounding dimensions, such as using a magnifying glass, you bring in those visible fields within view while standing within this dimension. However, the crystals that are artificially compounding the signal of those waves are merely that, artificial in terms of what a person can normally view or sense. If the particle velocity of your DNA were accelerated from where they are now, you would be able to stand in the exact same place on earth and see a completely different reality, because your antennae (your pineal gland) would be able to naturally pick up these higher frequencies, translate them into material reality and project them onto your *inner-eye viewing screen*. Until you remove the hardened calcium shell from your antennae, you will continue to be unable to focus outside of this visible spectrum without the help of magnifying glasses and telescopes. And right now, your world is changing around you every single day as we approach the peak of the Stellar Activation Cycle. If there were ever a time to work on removing the calcium from your pineal gland, it is now. You can't respond to what you can't see or sense.

The experiment above where the strength of the waves coming off of the moon are multiplied and therefore being allowed to affect our water (amneofluid) on a different scale than it could otherwise do, wasn't a 3rd Dimensional experiment so much as it was a multidimensional experiment. And until someone mentions that fact, it will continue to fly under the radar as if merely a phenomenon (which is another word for something you don't understand yet).

LAMBERTIAN COSINE LAW

Below left is a photo of a round ball with one light reflecting from its surface in a very small area. The Lambertian Cosine Law (notice this is not a *theory*, but a known *law* of physics) proves beyond speculation that a sphere cannot reflect light from more than about 7% of its mass due to the laws of refraction. Meaning that if the moon were reflecting the sun's light, then the

Decoding The Hive

creation of gravity, light, time and the god particle

moon would be around 15x larger than what you see with the eye. If this were the case, then infrared telescopes would easily be able to see the darker portions, even if the naked eye were unable to. But that's not the case. The entire surface of the moon is 100% visible on a clear, full-moon night. If the moon was reflecting light, and it wasn't a flat disc, then there would be no stars visible within the photo on the right at all because the rest of the moon that wasn't reflecting light would be blocking them all out and far beyond. By all known laws of physics, the moon generates its own light and the generation principle of that light is not known by science:



If the moon were illuminated by the sun's *light rays*, then the only time it would be visible would be when the sun's rays would be able to reach it on a direct course. Crescent and partial moons would only appear when earth was partially blocking those rays. That means that this unretouched image below would a physical, **scientific** impossibility, as the earth is nowhere near that direct path, as this is broad daylight taken *yesterday, 1/12/2017*:

Decoding The Hive

creation of gravity, light, time and the god particle



The daytime partial and crescent moon has been a constant reoccurrence in the skies around the globe since recorded history:

Decoding The Hive

creation of gravity, light, time and the god particle



To get answers regarding the moon from my contact, I had proven beyond speculation that the moon is neither spinning, nor reflecting sunlight, backed by hard science. Council has confirmed these facts and has added much more information about it, but they have always stopped short of telling me HOW it generates its own light and casts a perpetual holographic face, leaving me to speculate on my own regarding that one element. So this following explanation has yet to be verified by my sources, but theory based on (actual) science, mixed with what they verify as correct:

The Lunar Earth Command Module (LECM) casts its own hologram, projects the gobo patterns of the Zodiac and the visible stars as seen from earth-view and projects its light by transducing the frequencies from our second and now-hidden organic sun into a vastly dimmed-down, pulsating, electromagnetic cold-fusion wave force. The rays from that sun would have had to have been built on a completely different platform (physical laws) than the rays coming off of our current sun, and this would partially explain why it was

Decoding The Hive

creation of gravity, light, time and the god particle

blocked from view when it was, in order to amplify the effects of the Central Sun from the Metagalactic Core (and degrade human life rather than extend it).

Indeed, by now it has been clearly established that the moon is below the upper cloud line. I personally have witnessed clouds going behind the moon on more than one occasion from my position 1 ½ miles up on top of the high-Andes mountains where the clouds are often below. Of course you can find many photographic and video examples of this yourself online with a quick search. Here are some images found on the internet that aren't quite as dramatic as what I have seen personally, but it clearly shows the moon illuminating the clouds behind it while below the cloud line:



Decoding The Hive

creation of gravity, light, time and the god particle

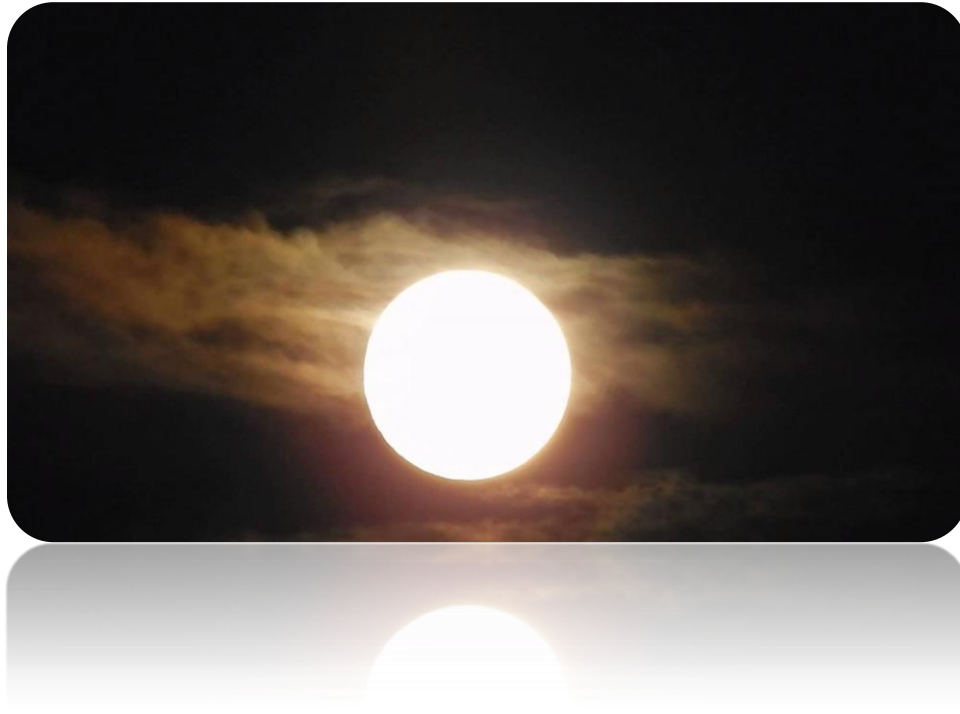

Many airline pilots and passengers have posted live video while flying over the top of the moon which appears almost like the sun when that close to the satellite. If the moon were not projecting its own light, then how would it be able to reflect light from the sun while hidden inside the dense cloak of heavy (and dark) clouds? The answer is it can't. It is impossible to deny what you are seeing, as these were taken from air planes, not from space:

Decoding The Hive

creation of gravity, light, time and the god particle



There is such a thing as *sublimation* that occurs around space crafts when they turn *photonic*. This has widely been reported repeatedly by SSP agents for many decades, so this isn't news I am revealing on the subject. When a time craft (any vehicle that turns into pure light in order to suspend the laws of physics to relocate) goes photonic, it sends out a heat-displacement temperature (that is sometimes slightly different than the atmosphere surrounding it) which creates a cloud that clings to the craft, even though it isn't producing higher temperatures of heat. Even if the craft itself has turned invisible, the clouds still remain and still conform to the shape of the vehicle. When the temperatures are in equilibrium there is no cloud and no indication that the craft is there at all. When jets fly at certain speeds, the friction created by the wings and nose cone creates the same affect, by now witnessed at air shows millions of times. I have saved many of these clouds formed by time crafts (which are distinctly in the numerous shapes that such crafts come in) and I will share those with you in a later volume of my report. I explain this only because what you are seeing in these photos of the moon below air traffic is the moon's heat radiation difference (colder or warmer, the **dew-point** sublimation still occurs) creating this same anomaly where it is surrounded tightly by clouds. Is it only coincidence that the column above is precisely surrounding just the ball of light? Not a chance. The moon is creating that cloud.

The same is shown in the next photo below. Notice the only light radiating from anywhere is coming from the moon, not from somewhere else then reflecting off of it:

Decoding The Hive

creation of gravity, light, time and the god particle



The moon is reportedly 238,855 miles above earth's surface. If this is so, then all these jets are somehow flying more than 238,800 miles above their highest possible elevation:



Decoding The Hive

creation of gravity, light, time and the god particle

Whether my theory about the missing second sun being turned into an energy device for the LECM is true or whether it isn't, it still remains *science-fact* that moonlight is not reproducible by man, it is not reflected sunlight, the moon does not spin, it is not in space but rather above the normal cloud line, it is a satellite and referred to as just that by every astrophysicist on the planet (meaning it is a device, not a planet), and is directly connected to circadian rhythm, to mental instability and to the dramatic reduction of melatonin secreted by the pineal gland.

FOSSIL FUEL AND THE SCHUMANN RESONANCE

Four subterranean rivers flow from the various Krystal Cathedrals one to the next in a geodesic pattern to imprint a manifestation code into this biofield. The amneo (water) flows both below the ocean as well as on the surface. At the same time, there are vast oceans of oil that float below those that mankind likes to call fossil fuel. Since the population consumes 100 million gallons of oil per day, multiplied by 365 days per year, even taking into account the incrementally increasing demand for oil over the decades since combustion engines entered modern times, that is still roughly 36 trillion gallons, enough to fill 55,300 Olympic-sized swimming pools and stretch around the world in gallon containers almost *300 times*. As my contact asked me as recently as 4 nights ago; *“just how many dinosaurs do they think **existed** anyway?”*.

And yes, dinosaurs did actually exist (much more recently than you have been led to believe by the way), but oil didn't come from the rotting corpses of these animals any more than it comes from pools of elephant oil scattered across Africa today. When animals die, they absorb back into the ecosystem, and unless there were hundreds of billions of ultra-giant beasts roaming earth at the time the planet was flash-frozen into an ice-age, then somehow magically migrated together to form huge vast groups with other dead frozen dinosaurs so they could become also magically swallowed up by the earth (in an event so far as-of-yet to be empirically quantified) to form a massively huge underground pool of sludge before the sun's rays could evaporate them or microorganisms could assimilate them, then it is absurd on every possible level to think that they were the source of this unthinkably massive resource. And yet, because you were taught that oil comes from dinosaurs in school, the entire collective on the planet still believes this incredible nonsense. Don't take my word for it, let's ask the US government what dog-and-pony-show they are rolling out now to replace such a preposterous fantasy today now that mankind is able to share and compare notes:

fe.doe.gov;

“Contrary to what many people believe, fossil fuels are not the remains of dead dinosaurs. In fact, most of the fossil fuels we find today were formed millions of years before the first dinosaurs. Fossil fuels were formed from plants and animals that lived 300 million years ago in primordial swamps and oceans.”

Millions of years before indeed. Try trillions of years before when this planet entered the 15 Level Time Matrix of Gaia and that black amneo fluid was placed here as the power source behind the flashline sequence of the spacetime fabric of this playing field.

Decoding The Hive

creation of gravity, light, time and the god particle

And even this new theory is just as absurd as the first one, imagining that plants and animals formed primordial swamps that were somehow instantly encapsulated (presumably by a massive meteoric event) that were also immune to the microorganisms that still assimilate all biological life forms at the end of each one's event horizon (cycle of life). If plants and animals were able to form swamps and oceans of nothing but percolating crude oil, then how is it mankind has never witnessed even a small pond of such today?

Joseph Goebbels:

"If you tell a lie big enough and keep repeating it, people will eventually come to believe it."

The reason that the quote above points out that the lie must be **big enough** for the masses to swallow it is because it must transcend their standard level of education, placing them into areas that are not within their expertise, so unless they are willing to learn incredibly complex subjects until the pigs come home, they will *never* be able to refute the statement. If I tell you that my pet dog turned into a gallon of oil (under the baking sun and lying on top of trillions of very much alive microorganisms that swallow every other dead pet into compost) and I turned that into gas to run my tractor, you would naturally call me insane. But if I tell you a story about a quadrillion beasts and sextillion tons of plants being swallowed up by a cosmic event the size of *100 million thermonuclear warheads* five-hundred gazillion years ago and that's what created oil, your eyes would glaze over and you would just mutter "of course, sure why not".

Oil does not mix with water. Science *can not* explain this. Even though both are liquid, they don't blend, even on a minor level. After a few minutes they simply seek out the particles of their own kind just like the liquid metal did in Terminator 2 (or as does mercury, also the Grecian name of Hermes, the god of alchemy and father of satanic Occult Hermeticism. Also keep in mind that Hermes' last name is in fact *Satain*.). This is because it was designed to remain separate for a reason. The unlimited underground oceans of oil are the lubricant of earth's biological body, just like oil is the fluid that allows all robots to function and pneumatic machinery to pave roads and build skyscrapers. It flows alongside the super-concentrated water (Deuterium) in the subterranean hydroducts (pneumatic channels) that lead from each Krystal Cathedral within the planetary energy grid in a geodesic to encompass the planet. And *why* is a good question.

The neutrinos and ions that continually bombard earth that are filled with energy were collected by a self-styled particle physicist many decades ago with a simple antennae that he fixed to the roof at his farm, with two wires leading down to a little wooden box that had some simple electronic components inside. The components measured in microseconds the pulsation (again, flashline sequence) of the ions striking the antennae when they would be positive or negative, and by extrapolating the positive particles, he simply sent those into a battery that would hold the charge. Absolutely free energy; just like solar panels collect the same energies from the invisible rays of the sun (they do not transfer the heat into energy such as a steam engine). This is completely cold energy. Though his invention was never patented by him at the time (due to extreme interference by black op agents), this has now become a well-known source of power within the free energy scientific circles called **Electromagnetic Harvesters**. That energy streams

Decoding The Hive

creation of gravity, light, time and the god particle

into this Time Matrix just as electricity streams into your toaster from your power outlet, providing the energy that all of the animation the hologram requires. Were this not so, then perhaps you have another explanation as to why more energy travels through our air each day in the form of ions than all the hydroelectric and nuclear power plants combined on planet create in a full year.

Those ions and neutrinos (“*the most abundant particles within creation*” according to modern science) which travel faster than the speed of light (oh, you haven’t heard about this yet?) recharge the planet through wireless power transfer which is called **SET**, coming up. You are about to learn more about water in this report than you may have ever imagined even existed. But since it is the life force within all material creation, you might want to know a thing or two about it. However, it is an indirect recharging or transfer system in place that involves oil.

WHAT OIL ACTUALLY IS

As explained in this paper, the most powerful thing that exists is crystal. It has been explained to me that crystal has unlimited power. And if nuclear science has anything to say about it, that happens to be science-fact, because they use liquid crystals to cause the detonation of other crystals to create a thermonuclear warhead. This is explained elsewhere in this paper in detail, so I won’t go back over that here other than to say that when heavy water (Deuterium) is blasted against crystal, it creates what we now call nuclear fuel by bombarding the atoms of the crystal rock with even more power and energy that is held inside the super-concentrated liquid crystal Deuterium. And just like when you rub the side of a balloon with your sleeve to give it a magnetic charge that causes it to stick to the wall, it transfers its energy into that **fuel** crystal (through static-electrical transfer or **SET** as just mentioned). Isn’t it curious that this form of energy transfer that literally powers the entire planet would be the exact same name as the “lord of earth”?

The ions and neutrinos pass through our atmosphere; through earth’s crust and recharge the oceans of oil that work like super-capacitors (like a giant *lithium ion* battery). The oil then moves past the heavy water and through static-electrical transfer, recharges the Deuterium that has found its way back to the bottom of the ocean and down through the crust, back to the inner hydroducts (earth’s blood arteries) where the oil and water make the transfer. Oil is the battery of earth, and liquid crystal amneo (water) is the wireless electrical cord that will be used to bring that energy to every crevice and crack as well as every living being within all of the playing field.

Once the heavy water Deuterium has been recharged, it travels through the hydroducts to each of the **Krystal Cathedral Energy Grids** and through SET, it recharges their broadcast energies which then allow the planet to generate its **Schumann Resonance**. Of course this broadcast is then intercepted by the **Nibiruean Diodic Crystal Grid**, lowered in frequency and in metronomic pulse-rate, and then it is broadcast into the earth’s morphogenetic field.

The heavy water that has already passed by the Energy Grids and then deposited into the rivers at the bottom of the ocean then begins its way back up to the surface gradually through the

Decoding The Hive

creation of gravity, light, time and the god particle

turbulence of the tide. There, the sun's waves will release the oxygen/hydrogen from the Aniline crystals through evaporation, releasing that energy and water into the atmosphere which permeates every inch of the planet through rain. Because the flashline sequence is now coded to Metatronic Pentagram Scalar Science, the water is now carrying the distorted particle-spin-rates of that lower vibration which feeds all life, but does so in a way that is highly perverted from what was supposed to have existed. It is this distorted Metatron code that causes the elliptic growth pattern shown in everything from pinecones to the hairs on the top of your head called the Fibonacci Sequence or the golden spiral. As stated previously, *organic life* grows in a perfect spiral that expands by frequency zone, not by parabolic brute force:

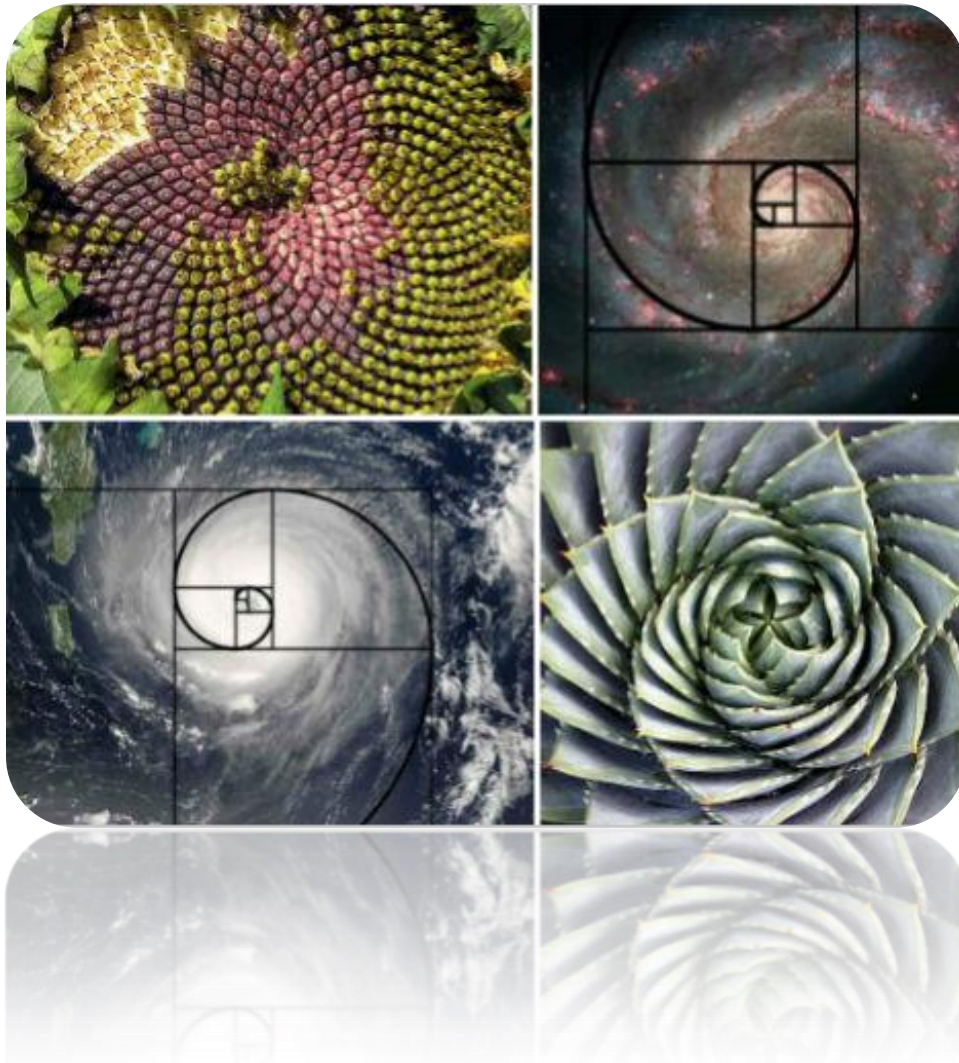

FLASHLINE SEQUENCE

Now under the heartbeat command of Metatron, the gravitational push of the liquid silicate is under the flashline sequence of the black sun, backed up by the Lunar Earth Command Module frequency waves which regulates the planet, and therefore regulates the pulse rate of the life

Decoding The Hive

creation of gravity, light, time and the god particle

force as well (circadian rhythm). The human heart was originally coded directly to the same organic pulse rate of earth's to support Angelic Gra-AI Line beings with eternal life. Now that has been replaced by the Pentagon Scalar Science as shown. So when our heart beats to send out its command to the body's organs, its waves are intercepted by the reptilian vagus nerve, recalibrated by the reptilian temporal lobe and forces the gravitational push to increase your circadian rhythm to a far faster flashline sequence than it had been designed to operate at. This affects how you view the world, how your body responds to the world (aging), how your memory records the world events, and thus, completely modulating what you think of as time as easily as the turn of a knob.

The reason your terrarium science project works to support life in your living room, is because the Liquid Silicate (amneo fluid matrix) inside that glass enclosure is one with that of the rest of the planet. That ecosystem cannot exist in space unless the spacecraft were channeling the frequencies of the heartbeat of a biodome from a life-supporting HOST planet. Humans have no idea of how to do that, that's why science is still trying to figure out how to create an artificial circadian rhythm for space flight and openly tell you it is still outside of their grasp.

Water is not just a minor-player in the grand scheme of life, as you can see it is directly connected to not just refreshing all life, but regulating the circadian biorhythm which your counterfeit body relies on. As explained, water can be thought of as liquid energy; each drop being filled with hundreds of crystal batteries inside. Also as mentioned, *all* animated life forms are robots that run on electricity. Human robots however, are *navigated* by the **sentience** driving them, unlike the rest which are running on software programs. Each one has a plasma-body, also called the *Krystal body* which is keyed to the never-ending delivery system of electricity provided by water. While water is physically used here like invisible electrical cords to continually power all animated life, it is also the pale-silver cord that connects an eternal Kryst being to the Standing Energy Fields of god-source. Your captors do not have such a cord, that is why your bioelectric energy field is considered *the* holy Gra-AI.

CHAPTER 15

JET LAG AND SLEEP INERTIA



If you've ever travelled, it is a good bet you have experienced jet lag. And if much of your travel has been in a car, you have also experienced something similar. That's because there is a common-denominator unspoken of that affects your biorhythm which affects how you feel. There is also a different jet lag that you get when you travel above the cloud-cover that has another, different physiological impact you experience as well. I am going to cover both of these here, along with sleep inertia, or grogginess you feel after waking up that is keyed to both. Surprise.

Here's what Wikipedia has to say about the subject of jet lag:

*Wiki: **Jet Lag;***

"Jet lag, medically referred to as desynchronosis and rarely as circadian dysrhythmia, is a physiological condition which results from alterations to the body's circadian rhythms resulting from rapid long-distance trans-meridian (east-west or west-east) travel on high-speed aircraft. For example, someone travelling from New York to London feels as

Decoding The Hive

creation of gravity, light, time and the god particle

if the time were five hours earlier than local time. Jet lag was previously classified as one of the circadian rhythm sleep disorders.

The condition of jet lag may last several days before the traveller is fully adjusted to the new time zone; a recovery period of one day per time zone crossed is a suggested guideline. Jet lag is especially an issue for airline pilots, crew, and frequent travellers. Airlines have regulations aimed at combating pilot fatigue caused by jet lag.”

When you travel from one time zone across another, you experience jet lag. Which has been explained a million times not just by Wiki, but in magazine articles and many self-edited blog posts, each time by another self-styled guessologist. In truth, your plasma-body (your electromagnetic field (or *Merkaba vehicle*) is undergoing particle-spin adjustment as your light body moves between spacetime quadrants through veils that separate each subtle and sometimes not-so-subtle spin-rates. You can see an accelerated example of this as your ears pop when traveling up a very steep mountain grade in a car, or going through atmospheres while your plane reaches thin air. But the effect on the body is more severe when transitioning dramatically from one dimension to the next, such as from Pacific Time to Eastern Time for instance.

Notice in the *official* report from Wiki above that Jet lag is especially an issue for airline pilots and crew, and the official answer is always to maintain sleep patterns and eating times, regardless of what hour on the clock is showing wherever you land. And while that might help beat jet lag to some degree, it isn't addressing the real issue at all. However, the one constant that is repeated over and over is for you to drink water. Lots of water, and avoid other things like soda or alcohol. Now why is it that merely going from LA to New York which is just 3 hours difference going to affect you in ways that are different from your sleeping or eating patterns and could be addressed by water intake? As we get deeper into the *circadian rhythm* issue, you will see there is much more going on here than anyone ever mentions. And water is more than just connected to this, as water is the invisible glue that holds a life-field together.

ELEVATION ATMOSPHERES

As will be illustrated later on this topic, life is set to certain elevations above and below the playing field where physically, if you pass certain points in either direction, you begin to die. This isn't because you were necessarily meant to be trapped inside a prison cell that is only this short distance to that short distance (though you are currently in that situation, but for other reasons), as the Time Matrix must have *delineated boundaries* that are distinctly defined in order to manage the field. If the earth were 100 million times bigger than it is, it would be exponentially more difficult to maintain a universal sensation of being within a uniform reality. As soon as your *suspension of disbelief* is fractured, even one time, then the illusion of reality is lost. It's not that we set out to disillusion you from the beginning (though again, you are also currently inside of an illusion that had not been planned for your stay), but without every element within your reality field working in synchronistic harmony, you would be unable to remain convinced that this was real life, something that you and I both set out to create in the first place. The playing field is limited just like your computer screen is limited in size. You don't need a

Decoding The Hive

creation of gravity, light, time and the god particle

world 100 million times larger in order to satisfactorily maintain a consistent existence while in a limited-ability manifestation.

By 22,000 feet elevation the circadian rhythm of earth's morphogenetic field begins to detach from the life-force. This keeps you from simply leaving this playing field and becoming trapped between dimensional spacetime fields where you would have no way to reenter a material (manifestation) field. This has to do with particle-spin-rate as mentioned at the start of this topic. Wavelengths that are broadcast at 101.5fm for example cannot be heard on your radio on 88.5fm. You signed up to be in the 3rd dimension at this point in your visit to the 15 Level Time Matrix of Gaia, which could be thought of as let's say "101.5fm" as just used. Only the frequencies within the spectrum of "101.5" are hosted here, meaning the only things you will be able to smell, taste, see, etc. will show up on the visible field for you to experience. Those frequencies are made up of aether particles that are spinning (and then consequently bouncing off of certain points within their spherical walls that create a geometric pattern), creating a harmonic sound, just like music made by hitting the strings on a guitar or keys on a keyboard of "G/C/D" or the like. You will not hear the music if I hit chords that are outside of your ear's frequency range, and in the same way you will not see or hear anything that are outside of your sense ranges created by the aether particles.

Because you can only see or taste or hear things that are inside of your designated frequency band, there is no reason for you to travel to areas that are playing let's say "88.5fm" music. Going too far below your surface-earth level, or too high above, is exactly like physically moving the radio dial to a frequency band that you are not tuned to hear. This means that your physical Avatar has no business being there (remember, you created this Time Matrix, so you have no reason to be upset that things work this way), and therefore begins to die. Jets fly at altitudes of commonly 36,000 feet, above the life-support system of surface-earth, which means that as soon as your plane reaches 2/3rds its cruising altitude, your body begins to disconnect from earth itself and her systems in place to keep your Avatar functioning within your designated life-zone. This is directly connected to circadian rhythm, and circadian rhythm is directly connected to water. Both of those things are directly connected to the particle-spin rate that makes up your plasma body, or your invisible electromagnetic-self.

*I don't expect you to fully grasp this section now, but by placing this into your subconscious where your mind can begin to piece together this rather vast new subject, it will become clearer to you, especially once you have finished the last chapters of this first two volumes explaining how **gravity** actually works and what the god particle actually does. This is not one of those books you can pick up and read the last page and understand "how the story ends", because this is not something you have been prepared for. And in fact, everything you have been taught up to this point has specifically been coded to keep you from understanding it once you finally have the answers before you. So you will have to keep a pad handy, place sticky-notes on certain pages and refer back to previous chapters in order to fully grasp the intended message. Most will need to re-read the entire volume a few times due to the level of brainwashing you have endured to this point. It will be up to you to push through on this fight for the truth, because it can never be simply handed to you in the form of a meme. You have an entire lifetime to unlearn and then an entire lifetime to relearn if you are going to make it out of this tunnel.*

Decoding The Hive

creation of gravity, light, time and the god particle

ELECTROMAGNETIC PLASMA FIELDS

Your light body or electric body that invisibly surrounds your manifest-self is maintained by your own specific frequency field. Think of it like your very own exclusive gaming console that only plays you, because the digital resistors and capacitors inside that generate your Avatar or electronic-self have uniquely come to this point of your existence based on the previous million, billion, or trillions of years of experiences that make up the vibration or Signature song of your one individuality. You can think of your Signature sound simply as personality. You have never met anyone exactly like you, no matter how many years you have or ever will live. No matter who it is that may be similar to you, they will never be exactly you. Even if you agree on 99% of everything, you will still like to mix ketchup, mustard and mayonnaise together for your fries or sprinkle both sugar and salt on your popcorn. These unique idiosyncrasies each have a specific particle-spin rate that pound out a precise geometric pattern that plays a unique song. Each sound is recorded in your own personal prana seed (that remains with you wherever you go while in or outside of manifestation). You have millions of different sounds that are then blended together in harmony that together then drum out a full symphony that plays a song made up of all those different notes. That is your song. No one else can or will ever be able to sing your song but you. It is the Signature of your Spirit Essence, of which there is only one within all of time.

Now imagine that *your song* in your prana seed (or your own personal CD) is played-back *through* the game-console of earth, who has the ability to translate your song into the platform of her console. This is a *translation* of “who you are” that is *her version* of what you would “look like”, “sound like”, “dance like” etc., based on her gaming-console parameters and electronics. Her electronics and processing systems are dictated by her voltage she is allowed to use while she hosts Dimensions 1, 2 and 3 within the **1st Density** of this **Time Matrix**. She is only allowed to use carbon-crystal frequencies here to power her gaming system. And those particle-spin-rates that power her system that translate “who you are” are held within a morphogenetic-field that surrounds you at all times while you are inside of her gaming system. They are *your electromagnetic pulse-rates* that are translated by *her electromagnetic pulse-rates* that are *tuned together* to continually translate “your song” into her expression or language that creates the frequency-wave spectra that continually broadcasts onto the *spacetime fabric* of this one dimension, causing a material **version** of you to appear.

How you feel is directly translated by your physical conditions surrounding you. If you eat the wrong things, you will feel “this way”, if you stand outside in the cold, you will feel “that way”. It is the same thing when you move into elevations where her life-support systems begin to disconnect. Think of her heartbeat as the metronome that keeps your heart beating at this precise symbiosis between your CD and her playing device. It is the *pulse-rate* of your time-sequence that projects your image of everything that you are while in manifestation. Her metronome mentioned previously called the **Schumann Resonance** has repeatedly been pointed to by science as the heartbeat of **circadian rhythm** that regulates human-life on this playing field. As you recall, it is regulated by the **Krystal Cathedral Planetary Energy Grids** that are powered by **water ions** to broadcast a rhythm into the morphogenetic field surrounding earth to “keep the

Decoding The Hive

creation of gravity, light, time and the god particle

beat” of your time-sequence synchronization. This regulates time, it regulates all your internal organs (involuntary bodily functions), it keeps your heartbeat in sequence with hers and without it, you would immediately die. Her heartbeat is broadcast out of the Crystal Grids and is carried by the combination of hydrogen and liquid amneo fluid (water), into higher elevations, and that beat automatically covers all surface layers of the mantle of earth that you are allowed to travel downward, to a point, into as well.

The microscopic crystals that carry the power of ions carried in water resonate with her heartbeat. Water is the delivery-system of circadian rhythm which can rebroadcast the Schumann Resonance only up so high, and down so low, as the energy that powers the system is tuned to these precise distances to keep the playing field contained. Jets fly outside of these parameters, just like astronauts travel outside of these parameters. You can no more *live on a jet* than you can *live in the International Space Station*, because your internal organs are missing the pulse-rate time sequencing for millions or billions of individual body functions that all must be synchronized in order for you to continue to manifest. Water carries this heartbeat inside of it, because the crystals held in the water resonate and re-broadcast the circadian rhythm from the Crystal Grids that code your body to function. That’s why they tell you to drink pure water. There are almost no crystals still carrying ionic energy above Mt. Everest height because the water that escorts them to regulate gravity has mostly all been collected at cloud level to generate the dispensation of energy across the planet. That’s why planes travel up to get to thin air for better fuel consumptions, outside of the friction caused by the crystal-content within the water gasses below, but when they do, they also leave the life support system of earth behind.

You don’t “feel like hell” for three days because you traveled to New York, you feel like hell because you were dying the entire time you were in mid-flight.

MORE JET LAG

This is not entirely the reason your body feels so bad from traveling, but it is certainly the most lingering of the battles your body must then fight back from. Traveling across time zones also affects you, albeit much more instantly than your disconnection from circadian rhythm. As your light body is made up of electromagnetic energy particles as just explained, they must hold the perfect **pitch of your song**, which are affected by **passing between** dimensions. As explained previously, 3-D earth (where you live) is made up of many different dimensions within the one broader field of the full 3rd Dimension. It is separated by time zones that are not organic to earth, but are time-sequenced pulse-rate zones that support intellect or intelligence-quotient (IQ).

The time-zones of current-earth have been delineated for you by the **chronograph of Cronus** that dictate what your watch must be set to (*legally enforced* on 95% of earth’s landmass). These zones do not separate you based on the sun’s position as mentioned, but by the separation of kingdoms ruled by various beings who own all the chattel in each one’s respective lands. Lands where they dictate eras, much like a school-teacher dictates what you will be studying that day and when you are allowed to go to recess. You are allowed “this much technology” and it will be reinforced by *that exact format* of religion for those lands (which is *the primary tool of enslavement* of all of mankind). However, as you have already noticed, religious ideologies and

Decoding The Hive

creation of gravity, light, time and the god particle

customs vary from country to country. But if you look closer, you will find they are more precisely delineated by *time zones*.

The frequencies now emitting from each individual Krystal Cathedral are tuned to different settings that delineate that one timeline sequence, just as church cathedrals dictate their own scalar codes through the shape of the precise angles and combinations of arches which create resonance chambers that reverberate the harmonic message of the notes emitted by choirs and congregations while singing ciphered aether commands called **hymns**. If you think that church cathedrals are only coincidentally named after the Krystal Cathedrals by accident, you need to look into cymatics a bit deeper. When you intone precise frequencies into a Tonoscope, sand particles don't accidentally take the shape of precise geometric shapes, as they are holding the physical form of the code being transmitted by the sound. When you are standing inside an acoustic chamber and you sing into the architecture laid out before you, the sound that comes back can resonate completely differently depending on the redirection of certain harmonic notes in different octaves that shape the sound just like they orchestrate physical geometric shapes formed by the particles (sand) you can see, and the particles (atoms and DNA) that you can't see. Today we have adjustable acoustic panels that automatically calibrate the deflection of sonic waves to the listener's ear by computers:



In past eras when magnificent church cathedrals were built, they didn't have this luxury, so you will see differences between the cathedrals in let's say Rome, as compared to the same denomination's cathedrals in S. America. While the religion might be the same, the era or

Decoding The Hive

creation of gravity, light, time and the god particle

timeline sequencing codes chosen by the god of one locale is going to be different from the next because his vision of his world and his world's technologies, apparel, customs etc. follow his dictate, just like ordering a sandwich with no tomato:



Each land area is controlled silently through their own broadcast stations through obelisks and through carrier waves in every tv and radio station signal, and also by every cell phone tower in that area that repeat their message that you are unable to hear with your ears, but your subconscious neurotransmitters project into your DNA particle spin the song of that ruler and your heartbeat then rebroadcasts that song out into earth's morphogenetic field which carries it across that land mass with little bleed over. These are **drone entrainment signals** that reinforce the messages given by the priests over the pulpits, the teachers in the schools, broadcast reporters on the news, etc. which entrain all the peoples of the varying areas to accept structures to their lives they never even think about consciously, yet stunningly everyone in that area continues to maintain very strange cultural idiosyncrasies across the spectrum as if they are not seeing the very same major motion picture films as seen by every other group around the world that would make it clear their apparel, hair styles, etc. have been outdated decades or centuries ago. Collectively in each zone, the public simply obeys rules without even questioning them that

Decoding The Hive

creation of gravity, light, time and the god particle

would lead to riots anywhere else. Why? Because their minds are not their own, they are literally silently entrained by acoustics they don't even know exist:



In order to control the functions of the artificial Avatars they had transferred each human and human-hybrid into, the morphogenetic signature of each land would have to be saturated with continuous aether commands that fill the vibratory space of each quadrant vector. This has just been covered where the Schumann Resonance dictates the circadian rhythm that supports and also **controls** the life-field, but the deeper story is that the multiple worlds that exist in “the one world” are clearly delineated as a matter of utterly invisible dictate. In the last section I explained that earth herself was in control of her life field, but technically-speaking, while she continues to try to do her job in the same way as intended, her efforts are being supplanted by this ingenious and insidious mechanism. The Nibiru Grid which is the backbone of the Frequency Fence Program broadcasts out scalar-wave frequencies that actually dictates higher or lower IQs within each vector by regulating either more or less white noise to interrupt the brain and mind-functions of the peoples as chosen by that god.

This is how people from one country to the next seem to embrace different levels of existence, where just **15 miles** away beyond certain borders, such medieval practices and qualities of life would be absolutely unthinkable to accept. The frequency-band that each one operates within is technically a different dimension, due to the fact that the reality being broadcast comes in on a different channel than each other. These dimensions are moderated so that the artificial Avatars from each interdimension are able to pass into and out of each other, supporting the continuous suspension of disbelief in a rather uniform manner. At least in a manner that humans are willing to accept, since after-all, *it really is like that* “over there”. If given even a small amount of thought it would be apparent that what is happening “over there” is beyond despicable and

Decoding The Hive

creation of gravity, light, time and the god particle

abhorrent and anyone with even an ounce of civic compassion should be driven to no end trying to overthrow the regime that is perpetuating such misery on their own peoples. But since you are continually divided by sports and military patriotism, you simply allow it to continue, thinking that that's how the people there *like* to be treated, otherwise they wouldn't be so damn proud of their own government. Does anyone outside of Afghanistan honestly believe the people themselves chose the way of life they now deal with?

Kabul, Afghanistan, 1972



Kabul, Afghanistan, 2013



When you travel into another dimension that is further than normal (more than just one time zone) out of range of the spin-rate you have become accustomed to, your plasma-body particles must adjust to the new timeline/time-zone pulse-rate. This disrupts the workings of all the millions of operations going on within the translation of your prana-seed song as it plays out within that quadrant vector. You can simulate this rapid adjustment on a much smaller scale by

Decoding The Hive

creation of gravity, light, time and the god particle

standing up too quickly and experience your head spinning as the particles from the field you were just in adjust to the particle-spin-rate of those in the fabric above. As pointed out, the *National Institute of Standards and Technology* when performing a test regarding the different dimensions separating time and how clocks operate in their **Time Dilation** study points out, their atomic clocks keep time differently even 1 foot higher or lower than each other, proving that the gravitational push associated with the interconnected circadian rhythm and baryonic pressure delineates time separations. Which is just another way of saying frequency zone or dimension.

Typically when you travel across borders, you are not usually traveling over much distance, so the overlapping frequencies between your area and the new one have already transitioned you partially to that frequency pulse-rate and you don't feel the effects as radically as passing over many hundreds of miles in the span of a few minutes. However, you have noticed that even in a car you can experience jet-lag that is different than merely being fatigued from travel. The pulse-rate delineated time zones you are passing through are what your body is physically responding to that makes you sick or dizzy or both, not the travel.

SLEEP INERTIA

Sleep inertia is the technical term for the grogginess you feel when you wake in the morning. Ask yourself why it is they call it inertia, when you have been immobile and in fact sleeping to define your reaction to waking up. The definition of Inertia is *“the resistance of any physical object to any change in its state of motion; this includes changes to its speed, direction, or state of rest. It is the tendency of objects to keep moving in a straight line at constant velocity.”* In other-words, it has to do with “change of motion”. Though you were not jogging while totally immobile in bed, and when you wake, you do not suddenly sprint a 50-yard dash, they still connect this word to your sleep. That's because while you think you were only sleeping, in reality you were wide awake, only in a different dimension.

Sleep is the process of resting your physical Avatar, refreshing the muscles and nerves to prepare for the next *bout around the ring* as it were. When your body goes into hibernation-mode, it becomes inanimate and therefore of no use to your awareness. Your awareness never sleeps or rests, even for a moment. Like how they explain “god”, it just “is”, and has always been so, because you are from the eternal-life, eternal-awareness family of god. So as soon as your body begins to fade, your awareness simply travels to one of your other 1727 different lives you are living out concurrently to one-another, and *visit* if you will. Checking up on how your “other self is doing over there”. We call recollections of these visits REM sleep, an acronym for *rapid eye movement*. It is explained that the reason your eyes are moving so quickly is because you are imagining all sorts of activity while sleeping, and this is your most restful period between the sheets.

I hate to dissent yet again from the experts, but this is when you are actually living your life in a different frequency spectrum (dimension). The reason your eyes are moving in your sleep-state body is because part your awareness is keeping tabs on that Avatar, even when it is resting, because you are under contract to keep it well and safe. So part of your interdimensional nerves are directing your sleeping eyes toward the person or object you are actually looking at during

Decoding The Hive

creation of gravity, light, time and the god particle

your visit. And since your awareness has nearly fully disconnected from that sleeping Avatar, your body would be as disconnected from your awareness as possible, allowing it to completely or almost completely switch off to recharge. This would make REM time technically your most restful sleep as they claim.

While visiting your other life, your plasma field (Merkaba body) of course, follows you to that higher or lower dimension, which means that in order for you to reassume your corporeal body in this dimension, your plasma body must translate into manifest form here. And just like jet-lag, you feel the difference between particle-spin-rate from the transition. It is the spin-rate of your particles that science is really referring to when they coin the term sleep inertia, because you are physically transitioning between the motion in your visit to slamming to a dead-stop, waking back up in your physical body *which is now suddenly in a completely different dimension.*

CHAPTER 16

THE BLACK SUN



Sir Isaac Newton is the father of gravity because in *academic-speak*, he explained how it must work. After noticing the movement of the moon always encircling the earth, a stroke of genius hit him like the proverbial apple landing on his head that fateful day, proving to him that *what goes up must come down* must be because the apple is being **drawn** toward the largest *mass* of earth, earth itself, just like the moon's *attraction* to the planet. The falling apple didn't hit him on his head, but it **did** travel toward earth, so I will give him that his observation did lead to the notion that earth must have a gravitational quality to it, because after all, everything that goes up, certainly *does* seem to come back to earth. Significantly, it was **1666** (the exact same year the **Cestui Que Vie Trust Act** was passed in London during the black plague) when he began working on the mathemagics showing that the force of gravity decreased as the inverse square of the distance. You now believe his story because it was instituted precisely within the geometric fabric of manifestation-command **Keylon Codes** of the **666 Program**. The **1** is an identifier of who is commanding the code (false god AN), and the **666** following is the **Program** by which that particular Template Command generates a desired result. The **666 Program** is a

Decoding The Hive

creation of gravity, light, time and the god particle

magnificently deep subject dating back 250 billion years I will continue to explain more about as we go. For now, just realize that gravity is directly linked to time, and the manipulation (dilation) of time is how your artificial Chimera Reality is coming into your awareness. Your belief in the lie fuels the success of the program to keep you confused enough to remain in an induced sleep-state.

Its funny to me how science likes to point to the equations that prove the hypothesis of one thing or another, rather than going back to the original empirical observation that spawned the hypothesis to begin with and taking a look for themselves at the reasons why the duck waddles in the first place. In this case one has to wonder why it was that none of Newton's colleagues ever posed the question why earth wasn't being drawn any closer by that *gravitational attraction* of the sun or to Neptune or another planet greater than its size, but somehow magically stops before colliding head-on with that body. Or why they never thought to bother asking him to demonstrate his theory within the laws of physics on this plane in order to prove that his theory was anything more than just the musing of someone shading himself under a tree. If there is a magnetic attraction between a magnet and a piece of steel, they collide, period. There is no invisible shell between the two. Yet there is a magic shell between earth and the moon and earth and the sun that simply is not part of the equation of their *gravitational pull* toward each other.

Sounds an awful lot like how atoms work, doesn't it?

Sure, he showed that rocks of differing sizes would still hit earth at the same time if they were the same density of molecular construct, but that doesn't prove earth has a gravitational pull any more than water is wet because it is a liquid and not a gas or solid (which is not an answer). We know that apples *fall to the ground*, but there is no working example showing that earth has some sort of magic magnetic pull on *all things*. It does *not* have a gravitation pull against hydrogen for instance, and why is that? Because hydrogen is part of the particle process that produces gravitational *push* which is not dictated to by the mass of earth, the mass of a rock or the mass of a waddling duck. Remember, really BIG lies are supported by other lies, so the answer to what gravity actually is, is not hidden in just that one initial lie, it is sewn into the fabric of everything you have been told in science class, history class, math class, on the news and in every conversation that even remotely refers to the subject. That makes it nearly impossible to decode unless you like standing in the corner for an hour each day because you don't choose to mindlessly accept what the teacher is saying as if from the lips of god.

At the point where we are now in modern civilization, we have become *so entrenched* in the dogma of science that we fail to go any further back than the last *innovation* made *from* that *invention* to see if the invention was founded on logic or founded on something else. "*There are more ways than one to skin a cat*" the story goes. And for good reason, because all around the world you can find multiple *inventions* that solved the problem of the very same need that appear nothing at all like its cousins. We spend our time arguing the virtues of the flyswatter over flypaper, forgetting that the spider had his web all figured out before man was ever even born, dismissing that offhand as *archaic*. If its new, then it must be better.

Rather than going through the litany of reasons why Newton's Law of Universal Gravitation does not work, let's try to focus on the observable, true *laws* of physics. As mentioned, a *law* is

Decoding The Hive

creation of gravity, light, time and the god particle

different from a *theory*. A theory is what is meant to, through the application of mathematical equation, explain observation. A law is something that is immutable, repeatable and undeniable. Gravity is a law, *Newton's postulation* of gravity is a *theoretical* explanation which is now presented as fact. In Newton's case, his theory was based on math and science that was factually flawed from the creation of **artificial** numbers to begin with (explained more fully in a later report when we get deeper into **Vortex Math**), meaning that even if he were correct, it would be impossible for him to explain it using the system in place today. But that is not the case, and I will give you more evidence than necessary to understand what gravity actually is, and how the **black sun** plays a vital role in its creation. When Newton actually shows me a working model of how the earth's mass creates gravitational signatures, then I will believe it. Until then all it was and is, is a theory from a Hermetic Masonic mathemagician with an advanced degree in guessology.

HISTORIC NOTE

*Before I get into this subject too deeply, let me explain how **science** has established the rules that the academic community must adhere to today, now that we have computers that can quantify theories based on calculations trillions of times faster than had been in place when the science-game began. "Science" was once called **alchemy**, based on magic (unexplained phenomena). The father of alchemy was **Thoth Hermes Trismegistus**, son of **Marduk Satain (Zeus)**, also father of **Occult Hermeticism**. Hermes (as extensively covered in this paper) was considered the most influential pagan magician (alchemist) **of all time**.*

*By the Grecian and Roman eras, this technology had become the realm of what was called **natural philosophy** which had become accepted as mainstream (hence the word natural) wisdom, not just merely pagan mysticism. By the 16th century, a **scientist** was someone who was able to produce **philosophical conjectures** (out of nothing more than their imagination) that could not be **mathematically** (fake occult numerical system brought to the world by **Pythagoras, brother of Hermes**) refuted by other scientists (natural philosophers).*

*These new **philosophers (magicians)-turned-scientists** argued **equations** based on **postulations** and **theory**. The equations were made using **numbers** and **symbols** now accepted today as the mechanical architecture by which observation could be quantified into numerical value. They were not produced by working models within the limitations of the laws of physics, they were theories. This is why so often the model by which subsequent scientists measure their breakthroughs are compared to **theories** such as the **Theory of Relativity**, the **Theory of Evolution** or the **Pythagorean Theorem**.*

*The foundation of science is literally based on conjecture, not empirical evidence. No scientist today is able to get his paper published until he has satisfied the **THEOREMS** (guesses) established by the fathers of science first (brothers **Hermes and Pythagoras** and all subsequent fellow brothers of **the Craft of Hermeticism**). Meaning they **MUST prove that Einstein and Newton were RIGHT** before they can enter into the fabric of academia any new formulae to advance the platform.*

Decoding The Hive

creation of gravity, light, time and the god particle

*Meaning the system was broken before it even began, and the only platform offered initially to alchemy, science and mathematics had been handed to mankind by the **Seraphei-Seraphim Reptilians** of the lineage of **Marduk Satain**. Alchemy spawned **medicine** and at the time, **medicine** was also synonymous with **poison**. **Sir Isaac Newton**, the genius who came up with the Law of Gravity was a devout follower of not his immediate predecessors or peers, but of **Hermes Trismegistus**.*

Wikipedia: **Isaac Newton**;

*“In his Hypothesis of Light of 1675, Newton posited [**theorized**] the existence of the ether to transmit forces between particles. The contact with the theosophist [guessologist] Henry More, revived his interest in **alchemy**. He **replaced** the ether with **occult forces** based on **Hermetic** ideas of attraction and repulsion between particles. John Maynard Keynes, who acquired many of Newton's writings on alchemy, stated that "**Newton was not the first of the age of reason: He was the last of the magicians.**" Newton's interest in alchemy cannot be isolated from his contributions to science. This was at a time when there was **no clear distinction between alchemy and science**. Had he not relied on the **occult** idea of action at a distance, **across a vacuum** [which has been proven not to exist], he might not have developed his **theory of gravity**.”*

The **heat** at the core of the sun *does not exist*. No astronaut has ever taken a space walk in a swim suit because it is so much closer to the sun. **In fact** according to science, it is **450 degrees below zero** in the Stratosphere or above instead of being over 300, or 500 or 2000 degrees with *no protective ozone* between them and the *burning ball of fusion* we call the sun. Now why is that? (Realize that the ozone layer is merely 10 miles above earth and is the thickness of *two pennies* stacked on top of each other.) Of course they make wild claims about there being temperatures as high as 455 degrees Fahrenheit in some places as if there is something to block the radiation of heat in space they claim is a *hard vacuum* which would instantly transfer the temperature to a *uniform, non-particulate, non-variant* by virtue of not possessing any density-variation.

While NASA likes to make wild-eyed claims about how hot it is in space, at the same time they report that they use certain materials for the nose cone and other sections of the Space Shuttle such as **HRSI Ceramic** due to *the extremely low temperatures of space*, seemingly contradicting themselves yet again:

Wiki: **HRSI Ceramic**;

*“HRSI was primarily designed to withstand transition from areas of extremely low temperature (the void of space, about **-270 °C or -454 °F**) to the high temperatures of re-entry (caused by interaction, mostly compression at the hypersonic shock, between the gases of the upper atmosphere & the hull of the Space Shuttle, typically around 1,600 °C or 2,910 °F).”*

Decoding The Hive

creation of gravity, light, time and the god particle

Yet, we don't experience our car's front-end bursting into flames as we travel out of a blizzard that might have a chill-factor of more than 100 degrees below zero, while breaking out of the mountains into a very sunny, much warmer air. In fact, the front of the car is just as freezing cold as the back end if you have ever checked, so where is the temperature shock coming from exactly?

What they fail to mention is that there is an Atmospheric Membrane that surrounds the planet as mentioned in every ancient religion from the babble to the Quran, Torah, Bhagavad Gita, etc. etc. which is made out of crystal. Not solid crystal, but tiny crystals that form the protective layer around earth atmosphere to hold the breathable atmosphere in, and block the elements from between functioning playing fields out. Think slushy how it is collected together but still rather fluid. This is explained in greater detail later when we get to the **Gravitational Push** chapter. The Deuterium content (liquid) has been completely spent by the time these crystals reach the Membrane, making them crystal clear that forms a barrier that seems very much solid if approached from a direct path. While cutting through this shell on a 45 degree angle, those crystals generate tremendous heat from the friction, not unlike a tilling blade gets hot while cutting through soil. Because of the extreme speed the craft is traveling making reentry, the cone and the leading edge of the wings will all need to have extra-hard, hi-temp insulation. The extreme heat encountered by the **unmanned, drone space shuttles** was not caused by merely thin air or temperature variation. It is caused by friction.

SSP whistleblowers announced long ago the shuttles were drones if you had not heard, because they are unable to go into space with people aboard, as crews are unable to survive. Challenger's explosion was not an equipment failure. The craft was not allowed to leave earth's atmosphere due to its cargo, targeted by beings enforcing the non-nuclear proliferation of space. It did not result in any casualties:

Decoding The Hive

creation of gravity, light, time and the god particle



THE INKY BLACKNESS OF SPACE

When astronauts fix the space station or repair a satellite in space (high earth atmosphere), why do they need headlights on their helmets instead of a dark-tinted sun shield?

Why has there never been a single photo ever taken of the sun from anywhere outside of the atmosphere of earth other than by NASA or other disinformation agencies of the **Global Space-Alliance Program** (GSA), agreed to by all developed countries? *Not one?*

Why is there never any glare from the sun's rays washing out the photos and videos taken while in space?:

Decoding The Hive

creation of gravity, light, time and the god particle



Reported in national television interviews with Neil Armstrong, Buzz Aldrin, Leroy Chiao and many other astronauts (these are actually pilots, not astronauts) it has been reported repeatedly and for many decades that (each of these are verbatim quotes): “*space is a **deep black***” and “*there are no stars visible at any time*”, “*it is the darkest black you can imagine*”, “*blacker than black*”, “*a blackness that is hard to comprehend*”.

Why does NASA state clearly that the shape of earth is an oblate spheroid, then show us countless “photos” of earth as being perfectly spherical?:

Decoding The Hive

creation of gravity, light, time and the god particle

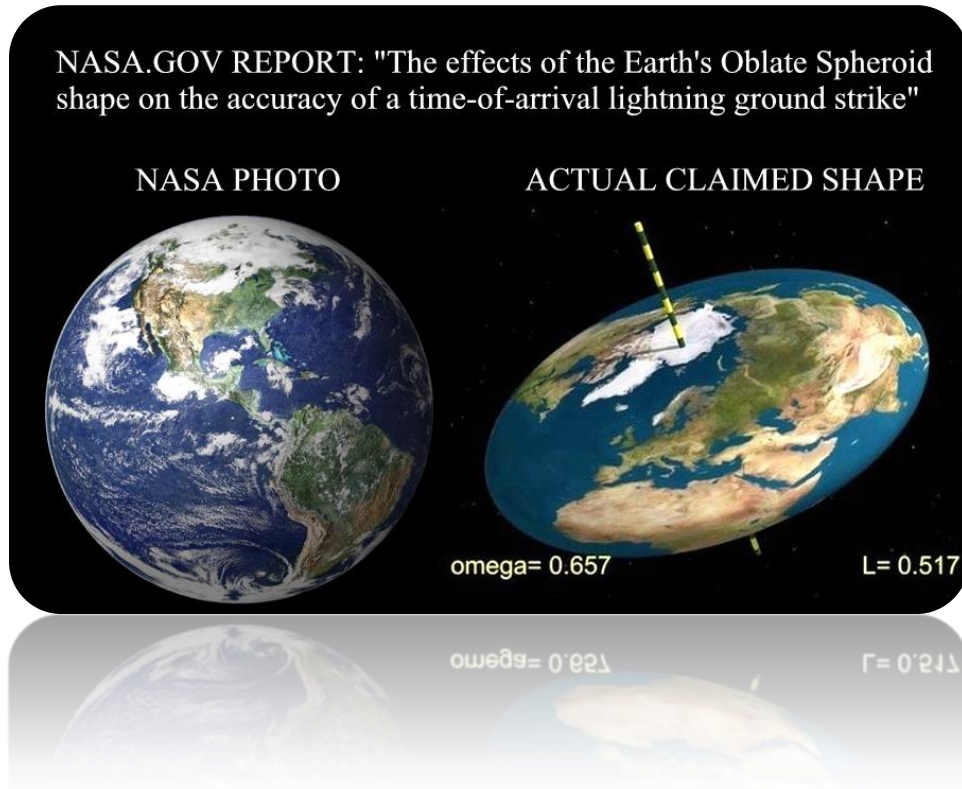

The photo below was reportedly taken from “space” that is one shot of a complete 360 degree pan of the universe. At no time is there any illumination from the sun, anywhere. This is suggested as “night time in space”. Hello? *Night time in space?* Does the sun *go to sleep?* Did it suddenly reduce down in size where tiny planets could completely block out 100% of its “light rays” somehow? At no time does the complete video ever show any brighter view than you see here, however someone forgot to mention to them not to photoshop-in the stars that the astronauts claim are not there:

Decoding The Hive

creation of gravity, light, time and the god particle



Wiki: Sun;

“Its diameter is about 109 times that of Earth, and its mass is about 330,000 times that of Earth, accounting for about 99.86% of the total mass of the Solar System”.

Wait; did this just state that the size of the sun *accounts for 99.86% of the entire mass within the solar system?* And somehow, this object that is the equivalent to a *lightbulb* in size compared to all other combined planets in the solar system equaling a *single particle of dust* in the *superdome* somehow radiates differently in different places? Really? What’s **blocking** that light and heat then if space is a “vacuum” made up of “1 particle of matter per cubic meter” which are *100% photons (invisible) particles?*

THE BLACK SUN’S INVISIBLE RAYS

There is zero illumination being cast from the sun, that’s because the sun factually does not emit light and it never has. When I first began my education, I spent a lot of time learning about the lies regarding space and when I learned that the sun had never been photographed from outside of the atmosphere of earth, I was absolutely stunned. That meant that everything they had been saying about space would have to be lies as well, so I investigated. I studied vast data regarding the science and physics of space and of course, eventually got down to the fact that the sun appears “*void of all illumination while viewed from low-earth orbit*” – which is the highest elevation man has ever reached above the cloud cover. Indeed, astrophysicists all refer to the sun as the *black sun* because it does not emit any light *or* heat.

In fact, there was even a website that had a very long-standing open cash offer for evidence of a single photo of the sun ever taken from space. No one had ever claimed it, because they didn’t exist. Try to find an astronaut from the Shuttle program or one of the guys who have supposedly

Decoding The Hive

creation of gravity, light, time and the god particle

spent decades now in space on ISS showing a single photo they took of the sun, or of space being anything other than pitch black with tiny points of light emanating from elsewhere. If you see what looks like a sun, then have it analyzed to look for photoshop artifacts and I am certain you will find them. Before the lock-down on internet searches from the late-2016 deregulation of the web there were far more sites out there for research on these issues than there is now. If you are looking for the “black sun” whistleblowers, they are all gone now as if they never existed, replaced by innumerable music videos of people singing about the black sun. But I have personally seen much disclosure on this before the change to allow corporations and countries to delete any topic from internet search results that they choose to censor for any reason.

The sun’s light and heat cannot come from a fusion reaction from its core if there is no fuel to continue that reaction. And if the fuel comes from the sun itself, then it is simple business to conclude that any isolated burning substance will exhaust its “matter” at an equal proportion to its energy release. If the sun is 94 million miles away from earth, it will need massive energy to get here for a single second, much less for billions of years of continual burn. Once its local fuel had been depleted, it would require other “matter” particles in order to continue the fusion reaction, and since there are *less than 1 particle of any type of matter in space per square meter*, that means there is literally nothing to burn, as NASA claims it is a **hard vacuum**.

Wiki: *Outer Space*;

*“Outer space, deep space, or just space, is the **void** that exists between celestial bodies, [keep this term “void” in mind for our later segment on space travel] including Earth. It is not completely empty, but consists of a hard vacuum containing a low density of particles, predominantly a plasma [photons] of hydrogen and helium as well as electromagnetic radiation, magnetic fields [around planets], neutrinos [light], dust [pieces of Terra Earth] and cosmic rays [light]. Plasma **with a number density of less than one hydrogen atom per cubic metre.**”*

It needs to be illustrated what size a hydrogen atom actually is, so you can get some sense of what is being discussed. First, the quantity of hydrogen atoms measured is done inside a cubic metre. This is 1.39x the size of a hot tub, or about half the size of a car. Now, imagine there is a single particle of sand at the bottom of that hot tub. Then realize that inside that one grain of sand are more molecules than there are grains of sand **in the entire world**. That would make the contents of oxygen in space less than one drop of water in all the oceans on earth. And without oxygen there is no such thing as flame. A fusion reaction is unable to sustain itself in space because there is **no nuclear source** for Deuterium, and Deuterium is the quantum of oxygen which is the quantum of all flame. That means that fusion literally cannot take place in space unless they are lying about fusion reactions requiring an oxidizer. The only heat ever produced on earth higher than 10,340° Fahrenheit was through a nuclear reaction. The only way a fusion reaction has been created on earth was with Deuterium which is a powerful enough oxidizer to generate such temperatures as hypothesized as produced by the sun. And Deuterium does not exist in space in **any quantity** according to science itself:

Wiki: *Deuterium*;

Decoding The Hive

creation of gravity, light, time and the god particle

“Deuterium is destroyed in the interiors of stars faster than it is produced.”

The simple truth is that from that distance, even if the sun were millions of times the size of earth (its not), and every particle of the sun split in a nuclear reaction and vaporized, the heat still wouldn't reach earth because the cold from outer space would immediately absorb it and dispense it across the entire solar system instantly because space is supposed to be a vacuum. A vacuum has no friction, which means the plasma (which is what science calls light in astrophysics) would not *travel* from *here to there*. It would simply BE *there* as in across every inch of the vacuum with all points at equal temperature. There wouldn't be cold spots or hot spots because nothing would resist its universal dispensation.

However, since you are not educated on how energy dispenses across a vacuum, you trust that what NASA says is true. But NASA says (officially) that space is hundreds of degrees in temperature in some places and then hundreds of degrees below zero in others so they can propagate the fantasy that they can actually navigate space where usable energy elements are a reality. They can't. And space doesn't actually have a temperature above absolute zero, because there is effectively zero particles in space to react to thermal radiation (heat):

NASA dot gov:

*“Objects in the void will eventually come to the **equilibrium temperature** of the **cosmic microwave background** [inside a vacuum], which is 2.7 Kelvin (2.7 degrees above absolute zero) [-455.26 Fahrenheit]. The cosmic background is a **sea of photons (light)** that are the remnants of the Big Bang, which has cooled down to 2.7 Kelvin over 15-20 billion years. The comment that **the void itself has no temperature** comes from the fact that temperature is usually defined with the random motions of matter, and if there is no matter, **there is no temperature**. But I (and many others) equate the cosmic background with the 'void' having an effective temperature of 2.7 Kelvin, even if there is no matter.” [I reject your reality and substitute my own] Dr. Eric Christian*

So while they claim that there cannot be a temperature holding any heat signature (plus OR minus) in a vacuum, and they claim space is a vacuum, they also say that they are able to read the temperature. Either they are lying about the vacuum, or they are lying about temperature, or both. They also claim that half of space is illuminated and the other half is not, while the only way to illuminate anything outside of the source itself is for particulates to reflect that light, which there are none. Which means either they are lying about the particulate content of space, or they are lying about how light and heat radiates *from the sun*. In this case, both. The **cosmic background** has been reported by NASA as having “*effectively zero particulates*”. And since hydrogen makes up 91% of all particulates within outer space (Wiki: **Outer Space**; “91% of atoms are hydrogen and 9% are helium, with 0.1% being atoms of elements heavier than hydrogen or helium...”), that means there is nothing for light to reflect back off of. I will repost more of that quote here again for convenience-sake:

*Wiki: **Outer Space**;*

Decoding The Hive

creation of gravity, light, time and the god particle

*“Outer space, deep space, or just space, is the **void** that exists between celestial bodies, including Earth. It is not completely empty, but consists of a hard vacuum containing a low density of particles, predominantly a plasma [**photons**] of hydrogen and helium as well as electromagnetic radiation, magnetic fields [around planets], neutrinos [light], dust and cosmic rays [light]. **Plasma with a number density of less than one hydrogen atom per cubic metre..”***

No 3rd dimensional *matter* exists in outer space other than tiny amounts of spacedust (Deuterium *salt* crystals which are interdimensional) that were blown into that sector when earth was partially blasted into vapor, because *space* hasn't been activated to form material structure (as explained soon in the section on **Creating The Spacetime Fabric**). Therefore it doesn't possess heat of any kind. Nor friction, nor wetness, nor energy that can be used to make 3rd dimensional fires, because it isn't inside the playing field of this planet or any other planet (playing field). Only light exists in outer space called **plasma** which is code for *photon*. Photons are electromagnetic within their quantum, but that is in photonic-form, not **3-D material form** such as **atomic**. Even if the sun did actually *burn*, it would not be able to sustain a burn for longer than a few seconds generated entirely by its *own* “**atomic**” elements and 100% of that heat would dissipate within the expanse of space instantaneously. It would have the same impact on space as a 100 watt lightbulb bursting inside the air within the Seattle Superdome; >/<zero. Their claim is that the sun is creating a fusion reaction that is self-feeding, but fusion reactions that happen within the atmosphere of earth cannot physically exist where there are no 3rd dimensional particles.

EARTH, SUN, MOON SET THE FLASHLINE SEQUENCE

The sun does not shine. The moon does not shine. The earth does not shine. But all three do set your circadian rhythm which is simply your *flashline-sequence* as mentioned rather repeatedly over the past chapters.

What the sun actually does is it emits **radio waves** that science hides inside the code word **radiation** (as in radiating from one spot to the other like **radio –radiation-** waves or **television** waves that are being **teleported** from here to there). These waves carry precise frequency patterns that speak to the bosons holding the quadrant-vectors of the spacetime fabric of the playing field of earth, and recharge the energy that will be used by the god particle Higgs Boson to power the pixels that projects the hologram we call reality.

The waves that perform the energy-delivery of earth are known as **neutrinos** which flood the planet every second of every day (already mentioned and also expanded on further later). The energy they deliver is in the form of the positive + side of static electricity, or one-half of electromagnetic energy that is in its static or stasis *resting state*. Also flooding in are ions which hold the magnetic – side of the equation which are also in resting or sleeping state. Yet even while sleeping, **ion** particles continually *draw onto the canvass* background their own girly patterns just like girls do in their notebooks. They manifest beauty and *color* to put it one way. And neutrinos print patterns too, but they are linear in form, or the **hard lines** that outflowing energy takes, and only a moment prior to “mating” with ions. The hard line energy (+) strikes the

Decoding The Hive

creation of gravity, light, time and the god particle

girly energy (-) within the liquid silicate (water) of earth, and in that moment, they create the $1+1=3$ of **electromagnetic** energy.

That energy charges the oil which charges the crystals in Deuterium heavy-water, which then charges the big crystals in earth's Temples. Because that energy is now magnetic, it is now pulsing. And while the pulsation of one atom may not amount to much to our senses, trillions of trillions of trillions of them combined, synchronize into one shared pulsation, just like metronomes who unexplainably find symbiosis and change themselves to follow the exact one pitch of all themselves combined. That creates the planetary heartbeat that then synchronizes with the collective heartbeat of all beings on the planet which is known as the morphogenetic field. Living beings' hearts within this atmosphere secretly beat in rhythm with earth's pulse and together this is called the **unified field**.

Once the Krystal Cathedrals have been recharged, it allows them to send out the frequency of its heartbeat into the morphogenetic field of surface-earth using the exact same process as a **piezoelectric crystal speaker** that transmits a vibration. Earth's frequency is below the spectrum that humans are able to hear, so this isn't something you will normally register, but that signal is called the Schumann Resonance we have covered in other chapters that sets the circadian rhythm that humans and other life forms must have in order to continue to animate. Your body's Schumann Resonance must be in sync with the pulse-rate of the incoming **radiation** from the sun (or moon) to complete the full code, which means that in order to live, you must be both *within the morphogenetic field of earth's atmosphere* (beating together as one), and also *within a line-of-sight to the sun* (or moon).

When both these on/off signals are captured by your body, it completes the metronomic pulse-rate of your own heart, synchronizing with the flashline sequence of the 3rd dimensional playing field. This is so that when you walk or move around, your body is in tune with the pulse-rate of the spacetime fabric that is flashing the pixels on and off, giving you the illusion that you are corporal or real. When you visit other dimensions within the 15 Level Time Matrix during your sleep, you visit frequency zones that are outside of your normal flashline sequence, so often you have the feeling that things move *too fast* or *too slow* from what you are used to while there, and you are not able to move around with the dexterity that you experience when you are awake in this dimension. If the sun **flashes too fast**, you seem like you are **running**, and if it pulses **too slowly**, it seems like you are in **slow motion**, or you can't *pick up your feet* to run away or the like.

When people with **photosensitive epilepsy** are presented with pulsating light, such as in haunted and fun houses equipped with strobe lights, they can go into seizures. But they can also be affected by standing shapes and contrasting colors as well. According to *epilepsy dot com*, they can be affected by:

- Television screens or computer monitors due to the flicker or rolling images
- Certain video games or TV broadcasts containing rapid flashes or alternating patterns of different colors
- Intense strobe lights like visual fire alarms

Decoding The Hive

creation of gravity, light, time and the god particle

- Natural light, such as sunlight, especially when shimmering off water, flickering through trees or through the slats of Venetian blinds
- Certain visual patterns, especially stripes of contrasting colors

(I will add that personally I am much more affected by flashing police lights in my rear-view mirror, but not in the same way.)

Here you can see that not only does light trigger these seizures, but also simple patterns such as black and white striped clothing. This is because anything holding a pattern or shape emits the same thing as a television broadcast or the sun: scalar waves. The radiation (radio waves) coming from the fonts of these words and letters from your screen or book, the waves projected by a television or radio broadcast, the waves from the WiFi around you and the sun's rays are all the same thing. But because we don't automatically see or hear waves from the previous 4 types just mentioned, we act like they don't exist. But science has been able to read the print inside of books just from the electromagnetic standing scalar waves radiating off of their pages many pages deep, right through the cover. All things are light (waves), but all things are also *frequency* (pulsing) waves.

The sun and moon's rays are exactly like the radio waves emitted by the earth, but within this Chimera construct, you believe you can "see" them and "feel" them. This is not true. You can only see light and feel heat that are emitted by the crystals in the spacetime fabric that are being orchestrated to flash on and flash off by the timing of their pulse-rates. The simple fact alone that the moon's **rays** are colder than **shadows** under a full moon should tell you that heat does not come from celestial bodies, it comes from the crystals that pulse within a playing-field atmosphere only. But the moon's affect and the sun's affect are both directly connected to your circadian rhythm, and it's because of their pulse-rates that you harmonize with your own **heartbeat** that **synchronizes** with the flashline sequence or refresh rate within the hologram.

LIFE IS MADE UP OF CREATED SENSES

The way that life works has been explained. All things are light and sound from the **Eternal Liquid Light and Sound Fields of god-source**. These fields can be thought of as the library of language for all intents and purposes, as I try to piece together a snapshot of how things come from nothing, into something. Nothing meaning non-material form into what we **sense** to be **material**. **SEN**sations, **SEN**sitivity, **SEN**ses are the *created functions* for **SEN**tience to experience being corporeal rather than just awareness. Each *sensation* is no more real than the illusion of time. Heat, cold, light, smell, touch, hearing, taste are all manufactured processes that we *think* (your only "real" sense) are organic. Just like time, they must be created and the physical Avatar you are in must be keyed to register these sensations in a flashline sequence in order to experience them. If the sun stopped flashing, you wouldn't **SEN**se anything.

CHAPTER 17

LIQUID CRYSTAL – THE SILICATE MATRIX



Water is, as they say, the essence of life.

Wiki: Water;

*“There is **no life** without water, which has been characterised as the “solvent of life”.*

The human body is not the only thing that cannot survive without water. Everything that is not completely static runs on water and everything that is static carries the *dry* essence of water in its makeup. You can live for a month without food, but it only takes 3 days to die without water. There’s a reason for that.

In order to run a Time Matrix, you need a power-supply system to run all the animations inside; otherwise you would have a static photo that never changes. All such animated creations are for want of a better word, robots. Every fish, bird, goat and human are biological robotoids that run

Decoding The Hive

creation of gravity, light, time and the god particle

on electricity. There is no exception to this rule. If they are in corporeal form (material), then they are no different than any robot in any factory across the planet, other than they are trillions of years more advanced so they manufacture their own muscles, skin and bones and some, such as “human” robots, carry Sentient awareness that allows them to make their own decisions. If each robot inside the Time Matrix were to plug a power-cord into a wall socket at the end of each day, they could function all day tomorrow for another cycle. But that is a lot of power cords and a lot of tedium to look after. Since Time Matrices are not based on simple understandings held today where there must be a cord connecting everything that must be powered in order to run, they employ what is called a **silicate matrix**. This is a simple way of describing an electricity delivery system without wires. Even today, earth scientists have developed safe, DC wireless energy, but that has yet to be released to the public, just like most other truly useful inventions have been blocked right there at the patent-office, as Einstein did for the Kybal while a lowly patent-clerk.

This is a carbon-**silica** world, and science can readily explain that to you if you have a few hours or days. Carbon is a heavy version of silica. Silica is another word for crystal. Because we use many names for the very same things to indicate the subtle differences in the density or composition of the material, it makes it simple to confuse anyone who doesn't have a master's degree in that particular subject. Silica is used for computer chips the size of your fingernail and also make up the batteries that power it. Computers that can send back a response to you with the results of 10 million search details in the blink of an eye. Why is that? How does silica manage this mysterious and utterly magical feat? Because silica fibers are *sentient*. There is a god-mind inside of them that can think and reason at a speed unthinkable for a human, and I will explain just *whose* mind is powering them later. It would take a team of researchers a year to bring back your search results that can be done in the matter of ½ of a second online with the toy computer you are using today. Black ops computers are millions of times faster even yet.

Decoding The Hive

creation of gravity, light, time and the god particle

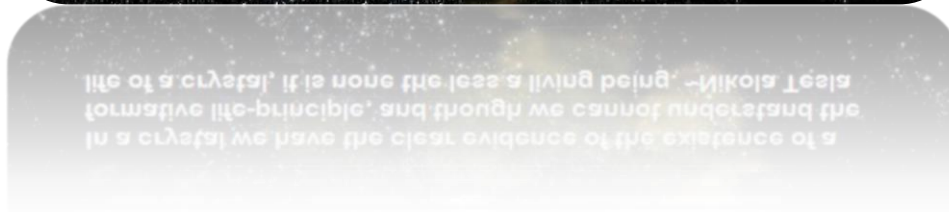
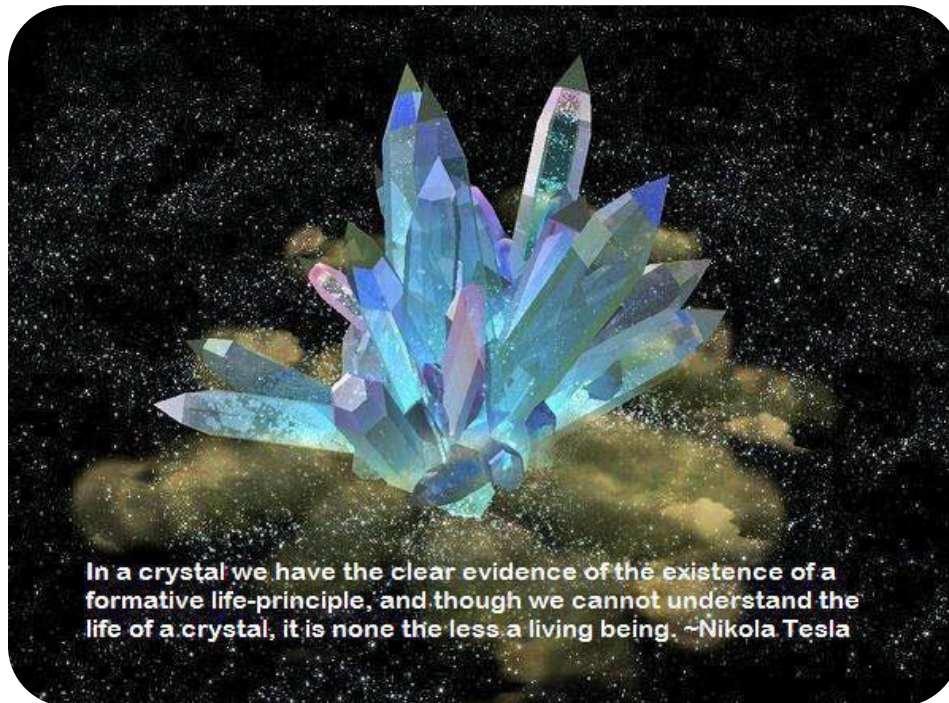

While we think of crystals as just the ones that you see hanging from chandeliers or we might use for energy healing, crystals are much more diverse than one could ever imagine.

Up to this point I have shown you that silica crystals are at the base of many things within your world, but once you take a close look at the word crystal and what falls under that category, you will clearly see that crystals literally make up the world you live in. They saturate the human body, as they also saturate all other biological life-forms. They make up the concrete you walk on to the plastic or ceramic cup you drink your coffee from, and even the coffee itself. You eat crystal, drink crystal and breathe crystal every single day of your life, just as every other thing that consumes anything. Crystal is pure *wireless* energy, and happens to be the data-bank of all **recordings**. These recordings are held in the stones around your garden, the memory in your cell-phone and your **Soul Essence** historical recordings within both the planetary crystal as well as the liquid crystal in each cell of your bloodstream and DNA. This is why our *life-system* is called the **Silicate Matrix**.

It has been taken so utterly for granted as to how recordings work, that we no longer even think twice about the concept at all. Of course we can record our voice. Of course we can record that day at the beach. But how do recordings come from a silica chip the size of a little fingernail exactly? We know that grooves on records play back the sound through the little chinks that were placed there when the needle vibrated while recording the sound, so it plays back the vibrations as they were placed there, but how do slabs of silica crystal do this without the chinks? How do

Decoding The Hive

creation of gravity, light, time and the god particle

computers play back the information stored inside? They tell you that diodes and resistors make these leaps, but there is more to the story than resistors. The silica crystal itself records because you ask it to, then it plays back that recording because you push the button and ask it to. Because they are Sentient.

Wiki: Crystal;

*“Examples of **large** crystals include **snowflakes**, **diamonds**, and **table salt**. Most inorganic solids are not crystals but polycrystals, i.e. many microscopic crystals fused together into a single solid. Examples of polycrystals include most **metals**, **rocks**, **ceramics**, and **ice**. A third category of solids is amorphous solids, where the atoms have no periodic structure whatsoever. Examples of amorphous solids include **glass**, **wax**, and many **plastics**.”*

I gave you a close-up view of the deposits left after boiling water down to a dry pan at the start of this report that science calls calcium. What is calcium? Note in the Wiki definition above how it states that snowflakes, ice and table salt are crystal. But it also goes on to list metal, rocks, ceramic, glass, wax and plastic as well. What was left in the bottom of your pan after the liquid water boiled off was also crystal, just named other things such as calcium. Here is what Wiki defines as various **calciums** as part or all of the following things:

- Metal
- Cement
- Mortar
- Limestone
- Gas
- Food additives
- Rocket propellant
- Textiles
- Fertilizer
- Glass
- Teeth
- Fireworks
- Torpedoes
- Flares
- Crayons
- Cosmetics
- Paint
- Plaster
- Fluorescent lights
- X-ray lighting
- Bone
- Enamel
- Salt

Decoding The Hive

creation of gravity, light, time and the god particle

And on it goes. This illustrates my point that not only is your world made up of silica crystal, but silica is called by thousands of different names, including calcium. The question is not **where** do we find crystal, it is where do we **NOT** find crystal. And of course there are thousands of different versions of crystals for thousands of different precise applications, but at the end of the day, you live within very much a Krystalline world. How it is used can either harness the basic molecular structure of crystal (such as building a brick building or constructing and powering a deer rifle), or it can harness the awareness of the crystal, unlocking the true power that crystal brings to the Silicate Matrix. One is easy to do for any level of civilization, the other, not so much. Crystal can form a hammer, or it can form a computer. Your choice. In order to harness the Sentience of crystal, you must speak to it in **cellular language**, or the language of the aether. Since we have covered the makeup of geometric patterns that lay at the foundation of all things within material creation, you will be able to grasp that speaking to crystal also takes the form of geometry as expressed through symbols that it has been coded to hear and respond to.

INSIDE A NANOCHIP

This is the *inside of a biomicrochip* under extreme magnification:



Decoding The Hive

creation of gravity, light, time and the god particle

Why is it you have never seen, on a micro-level, the inside of a silica computer chip before (underneath that flat-black cover)? Is there something you aren't supposed to know in there? Why would this nanochip have the tree of life stacked one over the other, layer after layer at its core exactly, and how is the computer functioning like a metal brain using silica to *think*? Here is the proof that your scientists do know the language spoken by the aether and just don't bother to mention it in school. It is the language they are speaking you have never even heard of that allows them to create around you a mixture of what you think is real and what is actually real in order to keep you dazed and confused. If you knew that the Keylons that carry the command of the **Eternal Unified First Field** of god-source particles that are 100% quantum-entangled to each other from one side of the cosmeias to the other are stored in the geometric patterns of every single genetic cell of your body, would you willingly allow them to teach you *common core math* in school that makes as much sense as arguing with a drunken pig, or would you be demanding some real answers?

Water is the life-blood of the surface-earth collective. Like the electrical waves flowing through a power cord, water is delivered refreshed to the surface world through evaporation and condensation. It recycles through **SET** or Static Electric Transfer, which refreshes its energy, then clouds drift those water droplets all over the planet to fall in another spot. The electricity inside the crystals literally powers the entire world. And here's where you say *didn't you just show us that the crystals in the water were left behind at the bottom of the pan?* Yes I did. But what you have to realize is that mere evaporation doesn't remove all the crystals, but it does remove some. And that is part of the secret. The other part of the secret is how that energy is used, and how it is refreshed by processes that we take absolutely for granted every day. All of which happens by the invisible rays of the *black sun*.

The power of microscopic crystals in water are hidden all around you, used unendingly in products you would never imagine, and **powered** by that element, because science never comes right out and tells you where the power is actually generated. If you knew that, then you would immediately begin looking for ways to harness it for yourself and skip the meter that they have you hooked up to. There is no such thing as energy that does not come from crystals in nature, and no such thing as energy in use today that isn't delivered by the very same thing. It can be used, then recharged by the absolutely free rays of the sun through neutrinos and ions, then used again with no loss of power. This is at the core of gunpowder and is found throughout granite, the material used to build electromagnetic energy generators (inverters) called Pyramids. The name of this crystal, **Natrolite**, is literally the etymological genesis to the word **ignite**:

Decoding The Hive

creation of gravity, light, time and the god particle



Natrolite is used to make potassium nitrate. Potassium nitrate is used to make *gunpowder*, *fireworks* and *rocket fuel*.

SILICA CRYSTAL CAPACITORS

A **capacitor** powers many things like the flash in your camera, and radio. It also powers:

Wiki: Applications of Capacitors;

*“huge pulses of current for many pulsed power applications. These include electromagnetic forming, Marx generators, pulsed lasers (especially TEA lasers), pulse forming networks, fusion research, and **particle accelerators.**” (CERN)*

CERN? That is some *serious* power! So what is inside of a capacitor that produces the electrical power on the scale of the draw of **300,000 homes** then?:

Decoding The Hive

creation of gravity, light, time and the god particle

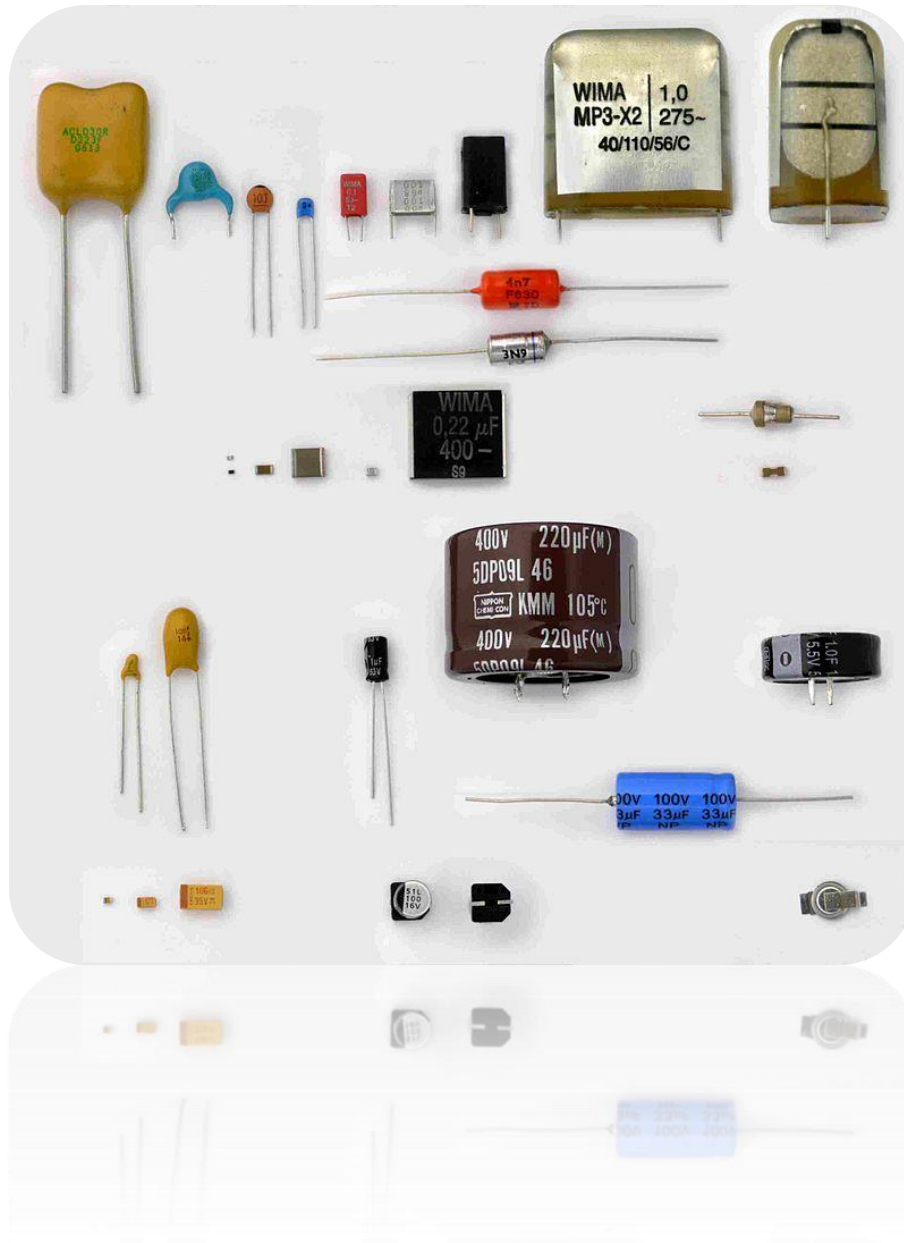

Here is perhaps a rather irritating breakdown that the average person has to go through in order to find out where energy comes from in this world where energy has to click through a meter from the outside of your house, or the screen of a gas-pump for you to be able to get to it. I could come right out and tell you where the most powerful energy on earth comes from, but that wouldn't serve to illustrate the number and levels of smoke screens that have been put in place to keep you from knowing. Here, I am showing you just how difficult it is to begin unpeeling the onion of what is really hiding inside of the little goodies inside your computer that perform the actual magic. How do you say the word *hidden* in 6,703 languages?

Inside a capacitor is something called *dielectric material*. You can go to Wikipedia and see for yourself that this material is broken down into scientific language with equations and codes, bizarre symbol references and on it goes. When you then ask what that material is made out of,

Decoding The Hive

creation of gravity, light, time and the god particle

then it leads you to *aluminum oxide*. Hey, its just metal right? Well, no, because aluminum and aluminum oxide are actually two different things:

Wiki: **Dielectric material:**

*“Aluminum oxide (in U.S. English) is a chemical compound of aluminium and oxygen with the chemical formula Al_2O_3 . It is the most commonly occurring of several aluminium oxides, and specifically identified as aluminium(III) oxide. It is commonly called **alumina**, and may also be called **aloxide**, **aloxite**, or **alundum** depending on particular forms or applications.”*

In fact, aluminum is simply being used to *grow* something called *oxide* under excitation of its particle makeup through an electrical charge:

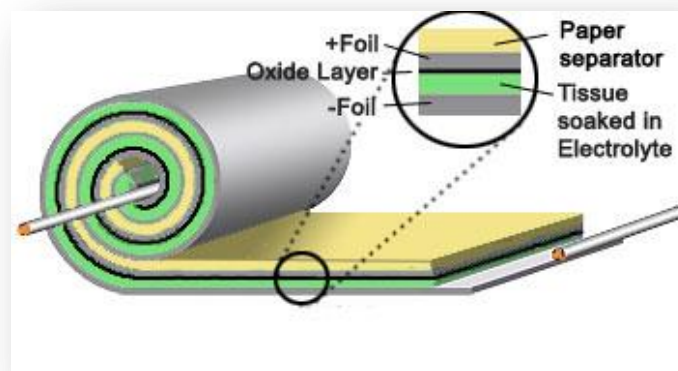

The electrical charge applied to the aluminum to create the oxide layer could be from heat, from electricity or simply from the sun. That last word might give you some clue where this is all heading.

This magic material simply manages to *produce* but not *conduct* energy. Let's see what dielectric material does shall we?:

Wiki: **Dielectric material: (cont)**

“Dielectrics are important for explaining various phenomena in electronics, optics, solid-state physics, and cell biophysics.”

So what they're saying is that this material not only powers electronics, optics and all solid-state physics (computers), but it also *runs the bodies of all living things*? Let's see what they use to make *dielectric material* out of then!:

Wiki: **Dielectric material: (cont)**

Decoding The Hive

creation of gravity, light, time and the god particle

“It occurs naturally in its crystalline polymorphic phase α -Al₂O₃ as the mineral corundum.”

Well, then what exactly is *dielectric aluminum oxide crystalline polymorphic phase α -Al₂O₃ corundum* then? By now, surely you would get to see what the actual substance is, since you now have the actual name of the material, you have the type of phase it is supposed to hold, and you even have the number where it sits on the energy scale, so let's see what it looks like:

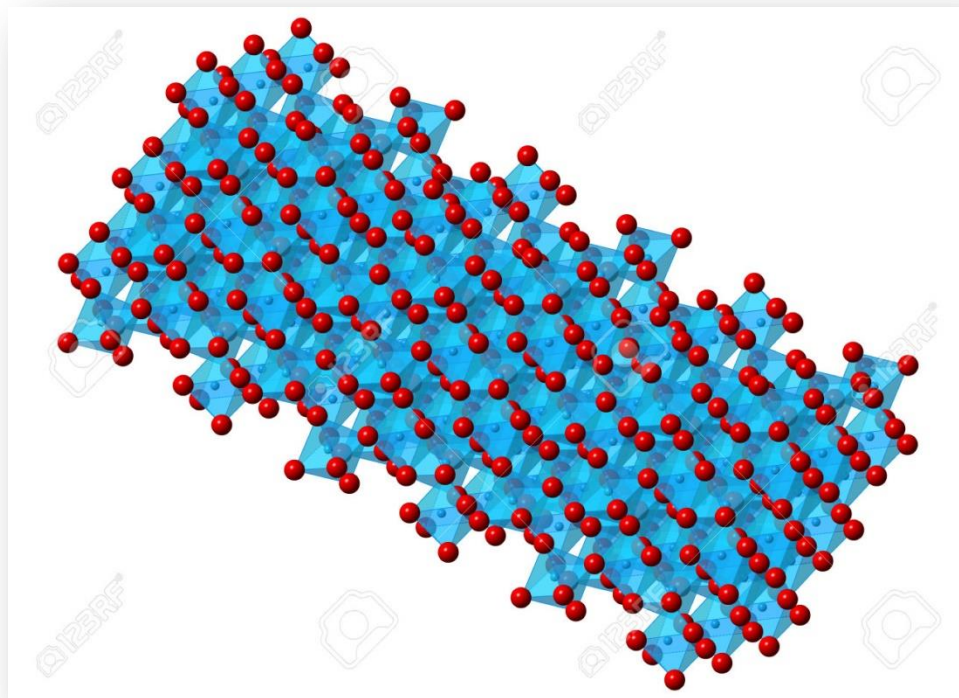

Well, I have never even seen *dielectric aluminum oxide crystalline polymorphic phase α -Al₂O₃ corundum* before, and I grew up in the woods on mountains filled with practically every material you can think of from gold to quartz, all sorts of woods and even seashells (on the tops of the mountains almost 2,000 feet above sea level). Maybe it has some other appearance if we keep digging deeper and deeper past the veils and veils of scientific terms?:

Decoding The Hive

creation of gravity, light, time and the god particle



This means this in real terms:

Decoding The Hive

creation of gravity, light, time and the god particle

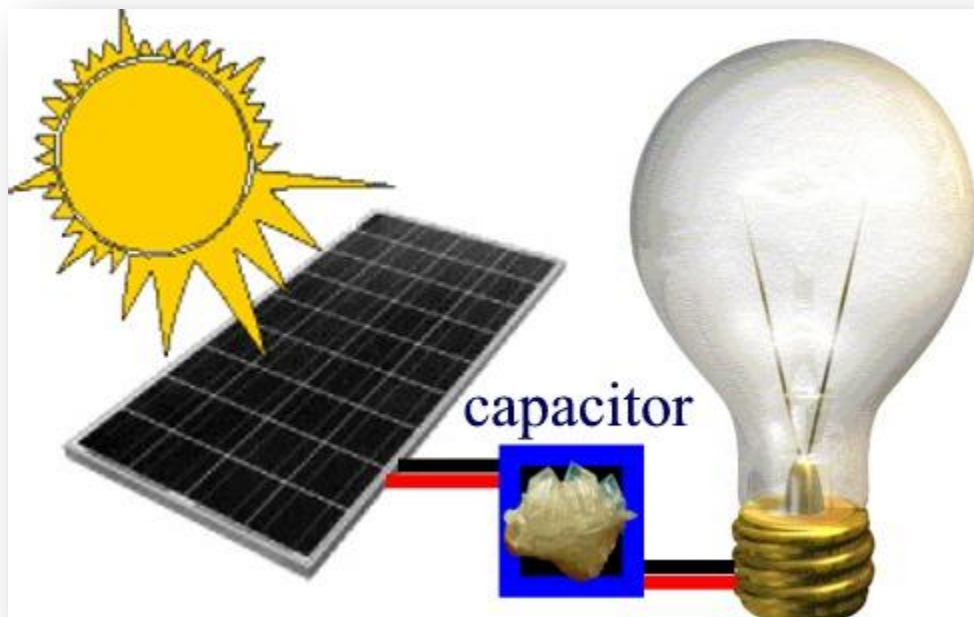

Oh, I forgot to mention that the solar panel wafers are encrusted *entirely* with crystals as shown in this microscopic view of a solar panel:

Decoding The Hive

creation of gravity, light, time and the god particle



LIQUID CRYSTAL

At the bottom of the ocean there are rivers, lakes and ponds that distinctly separate from the water above, just as clearly as if you were sitting by a stream with your line in the water. But how could this be true? Because it isn't just water, it is *liquid crystal*:

Decoding The Hive

creation of gravity, light, time and the god particle



Water which holds the secret to life itself is uniquely found in many versions of state. Naturally you are told that “water is water”, because you aren’t supposed to know just how powerful that element can be when in its purest genetic form. The water you see here is called **Deuterium Oxide**, or $2H_2O$, also known as simply **heavy water**. In many references within particle physics, it is merely referred to as **D**. It is the purest form of water on the planet, even though at this stage it isn’t actually drinking water. It will go through numerous stages between the bottom of the sea and your water faucet from this point. But since this is the single most powerful element on earth (at least in terms of powering all life and animated forms), I thought I would show you some pictures of it. This is liquid nuclear energy.

DEUTERIUM

Wiki: Deuterium;

*“(symbol D or $2H$, also known as heavy hydrogen) is one of two stable isotopes of hydrogen. The nucleus of deuterium, called a **deuteron**, contains **one proton and one neutron**, whereas the far more common **hydrogen** isotope, protium, has no neutron in the nucleus. Deuterium has a natural abundance in Earth's oceans of about one atom in 6420 of hydrogen. Thus deuterium accounts for approximately 0.0156% (or on a mass basis 0.0312%) of all the naturally occurring hydrogen in the oceans, while the most common isotope (hydrogen-1 or protium) accounts for more than 99.98%. The abundance of deuterium changes slightly from one kind of natural water to another (see Vienna Standard Mean Ocean Water).”*

Decoding The Hive

creation of gravity, light, time and the god particle

Note in the explanation of Deuterium above, that the hydrogen carried in its molecular structure has one proton *and* one neutron and accounts for only a tiny fraction of what is labeled as **hydrogen**. Hydrogen in the form of **protium** has **no neutron** in its nucleus and makes up nearly 100% of what is known as active hydrogen (what is already floating UP). This shows you that since the two hydrogen particles inside Deuterium are balanced, they act like a padlock on the energy held inside, because there must be an **imbalance** between the number of atomic particles inside the molecule in order for it to become *active*. What it absolutely fails to mention is the fact that hydrogen and oxygen are nearly the same word in scientific-speak as we will be coming to later. Oxygen is the biggest secret held within Deuterium and it is little wonder they skip over this portion of the description of heavy water. As far as the public knows, oxygen is created by trees that are bound to earth, making this element pretty tricky to take with you if you are traveling under water or above the tree lines. They are not saying that oxygen doesn't exist, but getting to oxygen in a way you can work with it happens to be the secret as you will see more about as we go. Also what isn't mentioned at all is why heavy water is heavy when it is apparently made up entirely of hydrogen that is the lightest element known to man. Perhaps Corundum should be spelled Conundrum, or perhaps it is and we just don't know how science uses letters...

As shown in great detail at the beginning of this report, there are positive and magnetic sides to any electrical energy flow. Energy **flow**, or *active energy* is made up of **two positive and one magnetic**, or **two magnetic and one positive** particles inside each atom in order for the **battery** of energy to be released as either a **proton** or a **neutron** label (which will indicate that this element is going to have an outgoing electric charge or an incoming magnetic charge). While the substance of hydrogen is present in the Deuterium, it is dormant and only awaits the positive or magnetic charge to enter its field in order to release the power held inside of the hydrogen. This process will happen naturally only when the waves of the sun come into play or when direct electric charges are applied. Until then, it sits at the bottom of the ocean and waits to be mixed with the water above before releasing its powerful force to rise up (literally) and do its job.

SCIENTIFIC CODE WORD FOR WATER, OXYGEN, ANILINE

Deuterium.

Deuterium, or liquid water is made up of oxygen and hydrogen which are both in stasis, the oxygen just much moreso than the hydrogen. When it is exposed to the sun's waves, those waves release those two elements at the same time, which means the hydrogen lifts the oxygen up higher than the surface of the sea where Deuterium exists because hydrogen breaks the laws of physics by rising with no exterior power source (that you have been told about). Oxygen and hydrogen almost exclusively come from Deuterium. These elements can be strangled out of other elements on earth, but only in small quantities. The earthly source of oxygen and hydrogen is the sea (ocean). Without water there is no life because there is no oxygen where there is no water.

Deuterium (water) exists in all oxygen molecules, and in fact, all forms of **water**, regardless if they are at the bottom of the ocean or highly transformed into gas, which is another word for the air we breathe. The closer you get to the sun, the less **Deuterium** content. The closer you get to

Decoding The Hive

creation of gravity, light, time and the god particle

the sun, the less **oxygen** content. This difference hasn't just been noted on surface-earth, but also above the Troposphere as well. At that elevation, there is no oxygen, and hydrogen particles are present in <1 particle per cubic meter (as just mentioned), as compared to **many millions per meter** just in earth's atmosphere (air) alone, which is trillions of trillions of times less than what exists in heavy water at the ocean floor. Oxygen/Hydrogen are so interrelated that if it weren't possible through extreme means to separate them under laboratory conditions, they would be called the same thing, even though they are two different things. One rises (hydrogen), and the other is the oxygen that allows the other to burn. Without oxygen, hydrogen only lifts higher into the sky. When oxygen is present, then hydrogen can be fuel. When they are separated, fire **can not exist**. This is because oxygen is actually a crystal that is a sentient being and can take the shape of existence in the form of flame, but it will not become flame anywhere it is not meant to be unless it is mechanically placed there. It does not get there by itself.

Hydrogen is water/oxygen's vehicle to move from the ocean floor to the top of the mountains and it is its **key** to unlock the power of the crystal. Beyond the point of the Troposphere there is no Deuterium, because in space (which is simply higher earth atmosphere) there is no need for fire and there is no need for oxygen. Man is not meant to be there, otherwise the crystals would happily travel to that level.

In what is **called** space, the oxygen has been removed from the hydrogen particles (which is not a standard occurrence on earth), and even in the **two places** throughout the galaxy that oxygen was found (next to two planets), the hydrogen content outnumbers oxygen a **million to one**. Outside of those two places in space, there is **zero** oxygen. Coincidentally, Deuterium simply does not exist in space, just like oxygen, because Deuterium is not just code word for water, it is **code word for oxygen** as well. So in real terms, one could literally write out "**Deuterium/Oxygen/Water**" if it weren't for the fact that **Hydrogen** is *always present* within that description, at least while you are inside the terrarium of earth's life space. The closer hydrogen gets to the sun and the Atmospheric Membrane (firmament), the less Deuterium it contains. This means that the *frequencies* of the sun are in direct proportion to Deuterium content *in every observable medium*. But since you think that water is **burned off** by the sun, that makes perfect sense. But that's not what's happening. The liquid of water/oxygen is being used by the playing field which is unlocked by the sun's waves. It isn't evaporated into nothing, it is powering life. So what does this have to do with anything? Everything. Because space isn't meant to be part of the life support system for humans, and science shows you this if you can parse through the garble to get to the facts.

According to modern science, "*The silica molecules in water are extremely difficult to separate from carbon molecules, acting as though they are stuck together by a bond that is uncanny*". Perhaps someone should tell them that carbon and silica are *fundamentally* bound to each other within this harmonic dimension, as this is the 3rd level in a 15 level graduating Time Matrix where each level gets **lighter** the higher you go **up**. Carbon silica is the earth-quantum ingredient of Deuterium that is called **liquid crystal** by science. Of course they don't mention that the liquid is water, or that Deuterium is literally filled with millions of carbon silica crystals inside, so much so that you can't even drink Deuterium as a water source because it is so full of crystal you will die of thirst. Carbon is the scientific code word for crystal, and carbon/crystal is what powers this playing field. Though silica can be separated from carbon through extreme means,

Decoding The Hive

creation of gravity, light, time and the god particle

they are meant to be a partnership that keeps the silica crystal from vibrating outside of the frequency spectrum of the 3rd dimension.

The scientist who is credited for discovering Deuterium, the particle that generates the most oxygen and therefore the most powerful of all particles, was **Harold C. Urey**. Here he is (on the far left) at the most prestigious **blood sacrifice Freemason ritual** known, the **Cremation of Care** at **Bohemian Grove** on Sept. 13th, 1942. Take a bow Harry:



GRAVITY

The carbon particles in water are not meant to leave the breathable atmosphere of earth's playing field and are the key component of what separates this dimension from the 4th. Without this bedrock difference, there would be no separation between us and there, where the atmosphere is based on pure silica without the much heavier density of carbon. You can say that carbon itself *is* the veil between this frequency and higher planes. And it is the basis of **gravity**. **Hydrogen LIFTS** the carbon crystal (**PUSHES UP**), the **crystal POWERS** the life force field from above, then the **carbon PUSHES DOWN** on that life force to keep the entire system in equilibrium. We are not done with that topic yet by any means, even though it is the synopsis to the secret of life because there is much more at play to allow all of this to work so flawlessly.

Deuterium that has already undergone evaporation, then transitions from **seawater** to **rain water** by the sun's invisible rays. Evaporating saltwater **loses its neutron**, turning water you cannot drink into water you can drink. It is only then that water becomes **Protium**, or **active hydrogen** which also adds **oxygen** during the transition. Notice we have taken **WATER** from the ocean, dried it, and somehow it has transitioned between **4 different names** already. The oscillation (vibration or **sound**) of the sun's rays produces a pitch that releases the neutron (**negative ion padlock**) from the nucleus cluster of heavy water (D). This **activates** the hydrogen and **adds**

Decoding The Hive

creation of gravity, light, time and the god particle

oxygen which we then call **air**. The difference between liquid Deuterium and dry (gaseous) hydrogen (H^2O) is just **sunlight**.

Taking a cup of Deuterium from the ocean floor, exposing it to sunlight then creates **Tritium** which then adds itself to the liquid. Tritium is **salt**. The core of Tritium is called a **Triton** (sound familiar?). You can even drink this water it is so nontoxic. Freezing this water that has only been merely exposed to sunlight then becomes **solid rocket fuel as used on the space shuttle and staged thermonuclear warheads**. The hydrogen is the fuel and the oxygen is the oxidizer. Bet they never taught you that rockets actually run on water in science class. (Remember this word “OX-ygen” for when we get into the preview of the **S@t@in CψphΞr** in the following chapters. You are about to meet the **Alpha** and the **Omega**.)

See volume two of decoding the hive for the second half of this initial report.

avalon sol
mission guide

Decoding The Hive

creation of gravity, light, time and the god particle

volume two

Decoding The Hive

creation of gravity, light, time and the god particle

decoding the hive

mission report vol two

personal contactee explains the creation of light, heat, gravity and the god particle

**revealing the tools of mankind's enslavement
final ascension cycle Co-Evolution BioRegenesis Treaty of Palaidor**

**by avalon sol
mission guide**

original text on behalf of the Guardian Alliance - Azurite Universal Templar Security Team - Emerald Council - in association with - The Interdimensional Association of Free Worlds

**Illustrations original and sourced from public domain
Copyright 2017 – all rights reserved
–decodingthehive.info-**

Decoding The Hive

creation of gravity, light, time and the god particle

NOTE: This report will occasionally be quoting some text from Wikipedia, which is a known Kybal disinformation platform. The only time it is quoted here is when the information has been independently researched from other reliable sources considered to be the most accurate details available in condensed form for the reader's benefit. Do not confuse these selections as a blanket endorsement of that or any other platform. Always cross verify any details you find there or anywhere else. Unlike Snopes, which is effectively nothing but disinformation when it comes to critical issues, Wiki does have many facts relatively correct as far as current historians agree to be accurate on otherwise random subjects to researchers backed up by laboratory results and multiple sources from across the spectrum. In those cases when I already know the report to be accurate within the scope of what is accessible, I will share the information with you as a starting point for your own frame of reference. Much of the data contained therein, if not most, is not 100% accurate and that is absolutely by design. All subject matter included in this disclosure has been researched extensively and in some cases continually for years before the untold story could be told. The accuracy of the statements made herein are within the limitations of being behind enemy lines using many sources including Wikipedia as more of a synopsis-site for wide-user contributions by historians and leading subject experts. This entire work can and should be vetted for accuracy across other sources before accepting even a single claim as fact. If you find any details that are misstated here, please contact me so they can be updated. ~avalon

Table of Contents

vol two

17 LIQUID CRYSTAL – THE SILICATE MATRIX 285: INSIDE A NANOCHIP 289, SILICA CRYSTAL CAPACITORS 292, LIQUID CRYSTAL 297, DEUTERIUM 298, SCIENTIFIC CODE WORD FOR WATER, OXYGEN, ANILINE 299, GRAVITY 301

18 AETHER 101: THE POWER OF THE GODS 309: ROCKET SLEDS TO HELL 310, THE BIG PICTURE OF TINY PARTICLES 311, SUN, WIND, RAIN AND THE GODS 315, THE TRINITY THREE 317, INTRODUCTION TO THE S@t@in Cϣphɛr 318

19 GLOBAL ENERGY DELIVERY SYSTEM 325: SUN“LIGHT” IS A CODE WORD 325, SEE THE SUN’S PULSE RATE WITH YOUR OWN PINEAL GLAND 326, RECHARGING THE PLASMA BODY 331, THE OMNIPOTENT POWER OF RA 332, THE SUN OF MAN (LIGHT AND LIFE) 332, GLOBAL ENERGY AND DEUTERIUM 333, GOD PARTICLE AND CERN 335, HYPOTHESIS OF LIGHT QUANTA 336, HIGGS BOSON 338, DEUTERIUM IS THERMONUCLEAR FUSION 339, TYPES OF HYDROGEN 341, MASS IS 3RD DIMENSIONAL LIGHT 342, HYDROGEN: CODE FOR ION ENERGY 344, URANIUM PURE OXYGEN IONIC CONDUCTOR 346

20 THE SCIENCE CϣPHɛR: 353: ATOMS, IONS AND SUBATOMIC PARTICLES 354, MAGNETIC ENERGY 355, ATOMIC “MATTER” 356, ADAM AND EVE AND ELECTRONS 356, TURNING INTO AN ATOM: ANTIGRAVITY 358, CRYSTALS ARE AETHER PARTICLES 361, IONS AND NEUTRINOS 362, MULTIDIMENSIONAL NEUTRINOS 363, DEFINITIONS OF NEUTRINOS 364, WAVES ARE RELAYED 368

21 THE NEUTRINO CΔEΣ: LEPTONS V_e, V_μ, V_τ 372: THE NEUTRINO CΔEΣ: LEPTONS V_e, V_μ, V_τ 374, LEPTON ELECTRON V_e 375, LEPTON MUON V_μ 376, MASONS ARE MESSENES 379, LEPTON TAU V_τ 385

22 THE NEUTRINO CΔEΣ: HOLY TRINITY 387: MU OF MUON = VOLTAGE 389, NU OF NINHURSAG SECRET Y AND V 390, ELECTRONS (-) 391, PICTOGRAPH TO CUNEIFORM 392, V IS GOD 393

23 THE NEUTRINO CΔEΣ: ALPHA AND OMEGA 398: TRI VECA CODE 399, NEUTRINO LEPTONS (+) AND IONS (-) 400, WAWWU AND SCIENTIFIC SIGNETS 402, OMEGA ELECTRONS 403, INSIDE AN ATOM 405, ALPHA MEANS DARK MATTER 406, HOW V MEANS DELTA + ALPHA + TRINITY 407, FINDING THE GOD PARTICLE 408, DELTA SYMBOL ALPHA AND THE ΔMEGA: $\Delta = V$ 416, BROKEN MATH 417, THE HUMAN PATSY 418, FINDING THE

Decoding The Hive

creation of gravity, light, time and the god particle

FAITH OF A MUSTARD SEED 419, LATTICE HYDRODYNAMIC THEORY MATHEMATICS 419, THE VACUOUS TRUTH ABOUT NUMBERS 420, LATTICE ORDER 423

24 THE NEUTRINO CADΞ: HIGGS BOSON 426: SCALAR FIELDS 428, QUADRANT VECTORS 431, NEUTRINOS ARE BOSONS 432, OXYGEN AND ALPHA PARTICLES 433, SAL(T) 435, THE MATRON OF MAGNETICS 436, THE ANUNNAKI PARTICLE 437

25 THE NEUTRINO CADΞ: MOMMA 442: BLOOD AND OIL 443, THE NEUTRINO EVENT 446, SCIENCE AND SYMBOLS 449, MOTHER OF ALL LIFE: MOMMA 452, WAWWU IS CODE FOR EVE 455, EVE IN A NUTSHELL 457, KRYSTAL SEED ATOM ALPHA AND THE OMEGA 458, IOTA = ION 459, THE IONIA EVE LEPTON 460, THE EVE (WAWWU) PROGRAM 461, THE FLIGHT OF PETER PAN 463, TRIFORCE OF THE DRAGON 467, ANGELS CAN FLY 468

26 THE NEUTRINO CADΞ: SCIENCE SYMBOLS 470: SAL(T) = NABLA = DELTA = ALPHA 474, DELTA/ALPHA = THE ALPHA AND THE OMEGA 475, EVE/WAWWU/SAL(T) = OXYGEN 476, EVE/WAWWU = SALT WATER GOD 477, GAMMA RAYS = WAWWU = ELOHIM 477, SCIENCE SYMBOLS SYNOPSIS 479, SIGNETS OF THE ANNU-ELOHIM 481, NUMEROLOGY 483

27 THE FIRE LETTER OF THE WHITE QUEEN 485: COMMAND PROGRAM TEMPLATES 488, FIRE LETTERS 488, EXAMPLE OF THE CREATION OF A FIRE LETTER 490, SCIENCE OF THE COMMAND SIGNET 491, REFERENCE CHART KEYLON COMMAND TEMPLATES 500, CREATING THE SIGNET 501

28 LIQUID ELECTROMAGNETIC ENERGY 511: QUANTUM MERKABA ENTANGLEMENT 512, PLANETARY BODIES 514, THE LIE OF FOSSIL FUEL 517, DEEP GREEN ENERGY 526

29 GRAVITATIONAL PUSH 528: WATER TYPES 530, HEAVY WATER GRAVITONS 531, THE GRAVITON 533, REENERGIZING DEUTERIUM GRAVITONS 534, THE BIG SECRET ABOUT THE SUN 538, LIQUID LIGHT 540, SWIMMING IN DEUTERIUM 540, SUFFOCATING IN THIN AIR 541, ION ANILINE GRAVITON 542

30 PLANETARY ENERGY 545: THE CREATION OF GRAVITY, HEAT, LIGHT, LIFE AND TIME 546, NEUTRINOS + ANILINE = GRAVITY 548, THREE ELEMENTS MUST BE PRESENT TO CREATE ILLUMINATION 552, ENERGY INVERSION 553, EGYPTIAN ELECTRICITY 555, NUCLEAR KRYPTONITE 558, WIRELESS LIQUID ENERGY 559, IONS AND UNLIMITED GLOBAL POWER 561, SNOW 562, MOTHER NATURE'S ETERNAL ENERGY PLATFORM 562, SEA LEVEL GRAVITATIONAL EQUILIBRIUM IN PSI 566

31 MECHANICS OF THE SPACETIME FABRIC 569: HOW LIGHT, HEAT, TIME, MASS AND GRAVITY WORK 572

32 CODE OF THE KRYSTAL SEED ATOM 577: RESURRECTIONS 577, KARMA IS AN OPERATING PARAMETER 579, THE CODE OF THE AETHER 581, KRYSTAL SEED ATOMS 581,

Decoding The Hive

creation of gravity, light, time and the god particle

PLAGIARISM 582, BEGINNING OF THE FALL 585, BORJHA RETROVIRUS INFESTATION 585,
THE REAL GENIES IN THE BOTTLE 590

33 THE REAL GOD PARTICLE 593: THE MILLENNIA PHOENIX 594, HIDDEN X
FACTOR 598, THE METATRON CUBE 599, THE HEXAHEDRON TETRAHEDRON 600,
THE GOD PARTICLE, THE SIGNET OF AN 602

CHAPTER 18

AETHER 101: THE POWER OF THE GODS

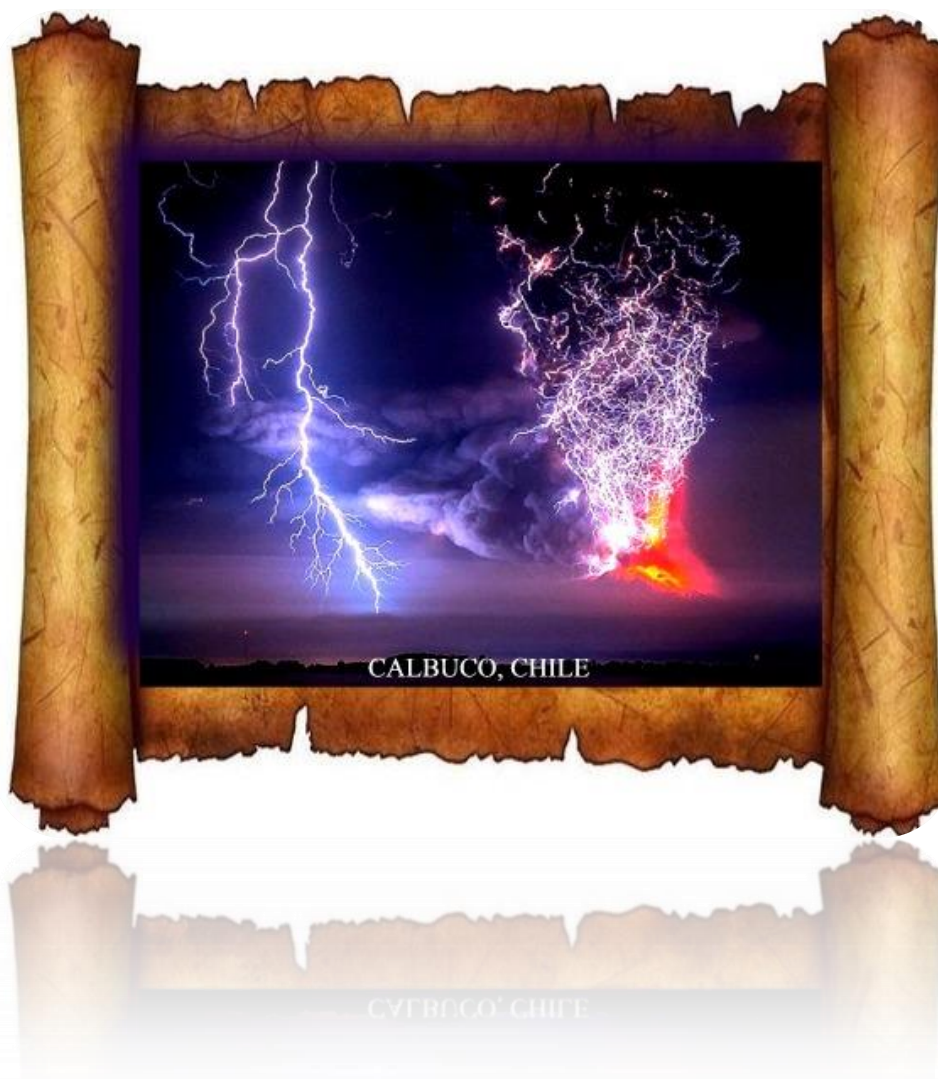

The image above and others like it come from volcano storms. Lightning storms that swarm active volcano eruptions. Show an image like this sometime on your Facebook wall and you will see what I have; people literally do not believe this is a natural event produced by mother nature. They will argue with you for hours that it has to be photoshopped, because our minds refuse to wrap around the notion that such unthinkable raw power can be real. Yet we have vaporized entire metropolises with a single thermonuclear warhead before, and still we cannot fathom its reality. And while we stand there with our mouths open in complete wonder witnessing a common lightning storm that has dropped down to our own farm, striking the ground just 100

Decoding The Hive

creation of gravity, light, time and the god particle

feet from our porch with the fury of a million sledgehammers, you knew all about this energy, long ago.

Because Sumerians, Greeks and Romans are depicted today as riding on chariots or in ox-carts wearing crude sandals half-naked, we think of our predecessors as dolts and mugs, barely able to keep warm at night or feed themselves. And that's just what you are supposed to think. That they rode on jackasses to get around, and had to go to bed as soon as the sun went down because they couldn't see.

Yet at the same time, there were notables mixed in at these very same times where some men were somehow more than just men, some were *gods*. They were gods because they could use energy in a way we still don't know how to use today. We have given them lofty titles and bowed before them and even sacrifice our own babies to their fires since before we even knew how to write our names in the sand. Yes, this was ZEUS himself, god of the gods, able to bring down lightning bolts from the heavens on command. Like the song goes, "you don't pull the mask off of no lone-ranger and you don't mess around Jim". *That dude is NO one to screw around with.*

ROCKET SLEDS TO HELL

I won't belabor this point here, as this is not a chapter on manifesting reality through belief, but I will just mention to you as a matter of no conjecture, that those people arguing that the above photo simply **cannot be real** will not be learning how to bring down those same powers from the heavens themselves like Zeus did anytime soon. If you refuse to believe, then your reality is just that. You will not realize your own power because you refuse to think you are anything more than just a stupid hooman who has no business jacking with science. **Science is alchemy** and alchemy is satanic and if you screw around with **witchcraft**, you will **burn in hell forever**.

Religions world-wide pride themselves on how god-fearing their flocks are.

Think about that for a moment. Does that sound like a *father* or a *mother* to you? Someone you must fear at all times? Or does that sound more like a criminally insane sociopathic narcissist? Like the man who beats his woman until she finally loves him, "god" continually spansks you into submission and then expects you to unquestioningly sing his praises. Religion doesn't teach you to believe in **all things** as had been originally taught in the Law of ONE, it teaches you only to believe in "god", and then he will go about creating while you go back to bended-knee, praying that what he has in mind for you won't be another round of global extinction where **only Noah** and his **kids** are worth saving. The only thing between you and *god* is the **controlled use of energy**, and until you believe you can use it to create, he will continue to handle creating your reality for you.

Energy, and that's what we are talking about here, isn't a figment of someone's imagination. It exists. People control it. You controlled it once. Zeus controlled it. So did Indra, Perun and Thor. But because you think of these as myths and fables, not *real people*, you are choosing to remain on Facebook arguing about what's not possible while men in little white lab coats quietly split

Decoding The Hive

creation of gravity, light, time and the god particle

atoms and run ocean liners for a year on a thimble full of air. If you can make a campfire that won't trail off and burn down the whole forest, then you already know how to control energy. It is up to you to learn how to control more of it than just lighting your cigarette without setting yourself on fire or not. I hate to break it to you, but Zeus and Thor still do control power, and more of it than you could possibly imagine from the relaxed comfort of your recliner. In the following chapters I will be showing you **Aether 101** for want of a better title. Aether is god, just like you are god. It carries the power to run reality and speaks a language you haven't relearned just yet. If you can *converse* with it, then you are able to light a simple candle using it, just as you can use a match today, or you can light the entire sky on fire, your choice.

Modern science has avoided the word aether, sometimes at ridiculous cost to their own gentry. Instead, they have renamed those elements neutrinos and ions and act like there is nothing to see here, while at the same time they spend more money on boson and ion colliders than the entire yearly operating capital of small countries to quietly study them and keep their findings all to themselves. Oh, they will release a few photos and write three lines of a report for their shareholders on their website, but 99% of what they find, they keep. This is Hermetically-sealed intel and unless you are an Initiate, you may as well read the Onion and watch the news for your advanced education.

Neutrinos and Ions are the secret energy delivery vehicles for earth. They flood the planet at all times from the standing energy fields of god source. Cern takes pictures of them. The alphabet was made with them. In most instances, these were the lowercase letters (the hidden POWERFUL letters), while their partners called CAPITALS are constructs using Keylon Grid mathematics to code the aether in duality with their little-brothers and sisters. There are also capital letters that come directly from these sub-atomic particle patterns as well, where satanic (Masonic) symbols, hieroglyphs and Sumerian letters came from. This is the raw meat of what "god" is; power. **One sub-atomic muon neutrino has 3,500 times** as much power as its vastly-larger big brother, the atom, and the atom can vaporize an entire metropolis. I show how that energy comes in, what it looks like and how it is transferred to the life-force of surface-earth to power all things in animation called life. This is the cellular language of the aether, hidden right inside the symbols of the alphabet. This will be merely a precursor to the soon-coming volume **The S@t@in Cϕphϛr**.

THE BIG PICTURE OF TINY PARTICLES

Viewing the big picture of particle and astrophysics as explained by science, it has become extremely obvious to me that how things work and what the public has been told are two different things.

*There is a fundamental disconnect between science and the public, in that the average human's brain-function is under extreme white noise, that is causing the "picture to blur" and the **radio station** to not come fully into clarity. This means that they are unable to compute subjects that are macroscopic in complexity. Scientists on the other hand are not average humans, and for the most part, are not even humans at all. They are using*

Decoding The Hive

creation of gravity, light, time and the god particle

software and hardware (their brain and their biological Avatar) that appears human in form, but what it is you cannot see allows them to comprehend at what we call an elevated IQ. And this doesn't mean that their "brains are bigger" than your brain or your neighbor's brain, it only means that their "radio" tunes in to more channels clearly than humans' do. They don't have the same level of white noise to contend with while stringing 40 equations together.

When a human looks at a subject, they can notice that the actor on the stage is wearing a white wig and is speaking in a Hungarian accent and the lights shining on the stage are tinted blue to give it a nighttime appearance. Because of the white noise also flooding into their mental receptors, these are the only elements of the production they are able to follow. Without the white noise that has been deliberately placed here to block human's mental capacities, their brains are quite sufficient to also see that the curtain behind the play is dark purple, and the crew behind the visible cast are doing 300 things to keep the production going. Plus mulling over the 4000 hours of preparation to get that production to the stage, along with all the trips to hardware, craft, cosmetic, electronic, fabric and other specialized stores that 20 people had to make 100 times to build the groundwork for that play. But because of beta waves creating distortions within the typical brain, it is simply outside of their spectrum to consider all these things during the play without losing the flow of the story. But non-human entities can follow all that and the play, plus all the subtle fidgeting of the audience in their chairs 5 rows in front and behind them, along with comprehensive analysis of how difficult it must have been to create 100 elements within the midnight scene.

*That means that the only people who can follow the strata of enormous detail regarding astrosciences (and most other sciences), **are not** humans. And because their physical bodies are products of specific Avatar sciences from competing species, their brains and the software that powers their waking-state mental processes are literally controlled by their creators (sort of like remote-controlled robots). The agenda of species A is to keep all the truth about higher science from the human-hybrids of species B, so when a species B scientist presents his "theory" about how space works, it is done in such a way as to confuse species A scientists, plus confuse 100% of the human species (and their respective hybrids) at the same time. Since there are multiple species all competing for the exact same thing, to enslave humans, that means that what makes it to bona fide, "recognized" scientific publications regarding that thread of scientific study is not only complicated (because they are dealing with extremely complex subjects containing thousands or millions of lines of code), but they are written in cipher that extremely intelligent competing species are meant to trip over on top of that. And since we are talking about dozens of different factions, science becomes more than just difficult to understand.*

So when I show you how the deception has played out, my explanations are going to often be outside of your ability to process very easily, so that may make the entire picture I am painting for you seem impossible to follow at times. You may want to throw your hands up in the air and dismiss the entire thing as rabbit pellets. It isn't because the information is crazy or you're crazy or stupid, it is because it was designed to have this effect on your

Decoding The Hive

creation of gravity, light, time and the god particle

brain. Which means when I get into how Alpha particles, oxygen particles or dark matter works, it will be extremely difficult to follow along. And you have been programmed since birth to dismiss what the collective consciousness of the human field doesn't understand, so refocusing on the details will seem counter-productive or "insane" for you to continue on with. But the answers are here, as long as you read the text, set the book down and think about it, and then do it again until the picture begins forming in your mind. Persevering though the white noise here is the only way you are going to see for yourself why mankind fell for the illusion around them. The honest truth is, the game was rigged from the outset, and humans never really stood a chance (in my personal opinion).

*It will be by will alone that you push through this where you take a stand and say that no one is going to pull the wool over your eyes again that you will be able to grasp that picture. You must realize at the outset that this mountain will seem more than vertical at times, but you **do** have the ability to see the truth. It won't come to you like "the sun comes up, so we can see, the sun goes down, so we can't", in a simple little pill to swallow. This involves time-coordinated quadrant scalar vectors, flashline-sequencing manipulation and sub-quantum physics on an intergalactic scale that will appear like a ball of fishing line the size of a building at times. And you have been conditioned since birth to reject anything that isn't as neatly condensed as the entire life of Nikola Tesla wrapped up in one sentence with a photo next to it of him sitting there surrounded by lightning bolts:*

Decoding The Hive

creation of gravity, light, time and the god particle



*While the meme is interesting, and thought-provoking, what it doesn't do is teach you a damn thing about what Tesla understood. He proved over and over again that energy was free, unlimited and easy to access. You know this. He proved it, not with theories, but with working models. But still, the only way to get people to even begin to comprehend that they live inside a locked-down mental prison, impassioned Indigos resort to memes in order to slap the public awake. And that's where the issue lies, there with the meme as we go on to the next funny cat video, choosing cognitive dissonance over education. Me too. I refused to let my teachers tell me anything after 13 years old because I knew they were wrong and no amount of beatings would change my mind about letting them fill my cup with their poison any longer. The hardest thing about the coming chapters is not **understanding** what has been written, but convincing yourself that this isn't just another massive disinformation campaign like all the other books that still exist today you have*

Decoding The Hive

creation of gravity, light, time and the god particle

pored over, only to realize by the last page they had been nothing but a waste of time, or worse, filling your cup with half-truths that block you from accepting the real truth once it finally appears.

*I take the time to mention this because I am not showing you how to tie your shoes, I am showing you how gravity is created. It will not sound like what your teachers taught you, so it will appear that this is merely a confused mind trying to confuse the rest of the world so he has company. Had the clues about where to even begin looking to explain how this works to the public not been handed to me from Council, I would also never have decoded the science cipher which is more of the **S@t@in Cϕhσ** that just seems to keep going on into infinity. The symbols that science uses, the numbers and letters they use in their equations, and their platform of mathematics to explain them are also involved on top of the mystery of space in all its ramifications, so when I talk about ancient Sumeria or pictographic alphabets, just realize that unless you look at all the pieces of the puzzle together, the big picture will never come into focus, and you will be right back to Tesla memes for your advanced education.*

*This was all just to say hang in there, because otherwise all this book will function as is a doorstep instead of the key you need to reach past the illusion of the matrix. If you fail to read and **comprehend** the following section, you will be unable to see exactly how it is that space, both within and outside of earth's playing field becomes scalar mapped, how each quadrant-vector (pixel) is powered, and therefore how things are able to either manifest or remain outside of this material visual spectrum.*

SUN, WIND, RAIN AND THE GODS

By this time, you should be well aware of two things:

- The **SECRET** to life can only be seen in **SMALL THINGS** (under microscopes and below in sub-atomic particles themselves)
and
- Science uses thousands of names for the exact same things so you will not be able to connect.the.dots.to.the.secret

This means that in order for us to finally understand how things really work, we will need to look at the fundamental particles that power each unique facet of the elements, and then we will have to see what titles science has placed on these particles so we can finally pick up the trail leading through the enchanted forest. At all times, keep in mind that there is no such thing as a particle. There never has been. When I use that word, it is only because that's how we have all learned to describe sound waves. **All things** are photons and **all photons** are Spirit beings. I will repeat this to you until you slap your computer because no one has ever bothered to mention this fundamental fact about how things work, and our brainwashing and programming has caused us to gloss over this point should we ever hear someone mention something about photonic energy. Even today, science still talks about "mass" and "matter" to absolutely no end, when they will

Decoding The Hive

creation of gravity, light, time and the god particle

tell you directly if you should ask, that there is no such thing as either one. Yet every equation they use to establish anything always refers back to mass and matter. When two protons are smashed together inside the CMS chamber at CERN to see what is inside of a fundamental particle (that is not made up of smaller particles), what comes from their complete annihilation are just two photons. Not shrapnel, bits of sand or any other matter; *just geometric light and the sound accompanying them.*

After years of study and frustration over how I would go about explaining in terms already used by science to describe to the masses how gravity actually works (*the* energy of earth), I resorted to just what you would do, I pleaded for help. I had been able to explain how it generally works since before my reeducation began, but not in scientific terminologies, because like you, I knew that science was deliberately set up as a maze with more turns than the yellow brick road to mislead the masses, so their terms meant nothing to me. Finally, after going over this topic *ad infinitum*, it was explained to me *where energy comes from* and exactly in which forms. Energy *powers* all things of course. It would be up to me to break down these different TYPES of energy forms in order to explain in scientific graphic detail to you the process by which earth then uses those energy sources to create all the elemental functions we observe around us. At first it won't make complete sense to you unless you were formally brainwashed in a universe-ity, just as it didn't to me, but by the end of *this first volume* of this report, if I have done my job properly, you will have a crystal-clear understanding of how things really work for the very first time. The highly unique properties of gravity, the way things are illuminated, how heat and cold are created, and how all of these things together create what we call life by a really small thing called the god particle.

“Earth energy is refreshed by neutrinos and ions from celestial energy source”

is probably the closest exact quote I can type out the answer I was given in part of the discussion with my contact from the Council of the IAFW. I will also show you what material they are then captured by, what material they are dispensed by, how neutrinos and ions break down, and how they interact with each other to the best of my ability. Also, this chapter will only scratch the surface of how your alphabet was designed, but it will certainly give you a good idea of where letters came from and why we call them symbols.

Since there are many processes involved in the **creation** of the building blocks of life, you will need to learn a few technical terms, but I will take the time to break down into real-world-dialogue what each one means to lift the veil from these all-encompassing hidden secrets.

Notice in the **DEUTERIUM** section above, that within all the different names that water goes under (just in this one small example), that **active** hydrogen (evaporated water) is technically protium and it must lose its neutron first to become active. What this means in simple terms is that the molecules you breathe are PROTONS (positive energy) which are ions **unlocked by neutrinos**. When an ion is unlocked, it infuses that atom with oxygen. Oxygen not only keeps you alive, but it forces you down to the earth's surface so you don't float off into space. It also infuses the atom with hydrogen which LIFTS oxygen to a certain level, so you don't sink to the bottom of the ocean. An unlocked ion maintains the equilibrium of life centered around the level of the seashore. It is there that you weigh 100%, and anywhere higher or lower than that point,

Decoding The Hive

creation of gravity, light, time and the god particle

your weight varies depending on the distance you are away from it. Surprise. Not only does time dilate as you leave that level, so does your density. Density is regulated by oxygen which doesn't exist where you are not allowed to survive.

Neutrinos are small neutral particles that are unaffected by the electromagnetic spectrum (which means that they travel THROUGH what is called matter without interaction). Simply put, neutrinos break all the rules in scientific terminology. **Atoms** are affected by gravity because they are “**3-D**” **energy** (to maintain the equilibrium of life centered around the seashore), and neutrinos are not, because they are interdimensional frequencies that need no equilibrium because they aren't manifesting, or taking corporeal form in this dimension. Science calls **3-D particles matter** and **interdimensional particles anti-matter**. All I am trying to do is label these different frequencies (which are **songs**) with terms you will be able to follow on a level that isn't as confusing.

“Particles” is a scientific word for sound and light. Only sound and light “exist” on earth outside of your “awareness”. This is a hologram. Some things seem solid, but this is only because of your senses which make them seem like “matter”. Not understanding this fundamental truth keeps us from understanding how the big picture actually comes into full-color.

THE TRINITY THREE

This brings us *immediately* to religion. Because there are only three hard-and-fast rules about the world we live in:

- 1) The sun will rise tomorrow morning
- 2) What goes up must come down
- 3) You *will* die

Not one of those constants is mankind able to quantify. Meaning that the only things that are immutable and unchangeable about life are each one, *100% mysteries*.

Not surprisingly, there are THREE gods worshipped by man when everything all boils down to their most basic elements. The **Trinity**. And the Trinity is called out by MANY (thousands) of names by many thousands of cultures down through history. I will be going through many dozens of them later on in this report. But the most basic constants from any era, culture, ideology and faith 100% of the time revolve around:

- 1) SUN
- 2) WATER
- 3) WIND

These three make up the universal single-constant of the earth. There are always the three elements, and there is always the one earth that makes up these three. Surprisingly, as you will see later, there are 3 elements that make up “atomic mass”, so those three make up what is

Decoding The Hive

creation of gravity, light, time and the god particle

simply called an **atom**. There are innumerable **lower gods** that make up the three (Isis, Inanna, Ishtar, Mary etc.), and those three always refer back to the **one**, which is a **multidimensional** god in how deification works, because at the core of religion is the power of the **3rd Dimensional energy** that allows anything to take **corporeal form**. This is why **Adam** was literally named after that particle (frequency wave) known as matter or **atom**. Adam or “atom” is simply another word for **manifestation**. Adam is the code name of their **physical** takeover and AN is code name for the SUNS of Ba'al who run the ants down in the chattel farm below. **Electromagnetic** means **physical** (1+1=3) **Trinity** and **stasis energy** means **aetheric**. AN poses as the aether itself in this equation, or; “the **one**”. 1+1=3 literally means positive and negative energy and the invisible “magic” of the aether that makes them work, is the **magnetic** quotient called AN. Much more on this to come, so don't worry if it doesn't yet make sense.

INTRODUCTION TO THE S@t@in Cϕphɛr

As a brief introduction to the **S@t@in Cϕphɛr**, “god letters” that are used in cipher code to stand for the sun, water and wind are usually in lowercase letters, and the fictional beings (people posing as gods) representing those elements are usually typed out in CAPITALS at the start of their title. This is following the exact same pattern used in fictional entities called Corporations, where INVENTORY IS ALL CAPITAL LETTERS as in THREE HOGS and FOUR BAGS OF RICE. Inventory is the fictional person, lowercase is usually the real person or group of beings. So LAWRENCE is a title or OFFICE and Lawrence Shinblatz might be the guy who happens to work that position at the moment. I AM is an example of this distinction, because I AM merely stands for the Michaelube, SUNS of Ba'al. The latter is the actual group, the fictional persona is the I AM. On earth, lowercase letters following the first CAPITALIZED letter typically denotes an earth-bound god. **Each** letter (or two letters) is a person, title, position or geographic location.

As an example, Khan stands for:

- K=Earth-level **King**
- h=Wawwu (earth-bound **god** that rules over the King)
- an=An (multidimensional **Emperor** over all earth-bound rulers)

You have the **position**, then who rules **over** that position by **mating** (making) electromagnetic energy, then you have the **ultimate ruler** from above who rules over the other two. Hence: **Trinity**. The **S@t@in Cϕphɛr** is riddled with upside-down and backwards grapheme letters from pictograph symbols that have been slanted, reversed, inverted and mirrored on a constant basis. As explained later, there is no such thing as up or down in the spirit world, so an **A** lying on its side or standing on its head is still exactly an **A**, just like a lowercase **a** can mean the same thing in certain instances. This gives you some idea of how this works.

Zeus begins with a capital Z for the graven image (earth position or title) being, then e, u and s are in lowercase. Lowercase **e** stands for the **sun** (as in **Elohim**, **electricity**, **electrons**, etc.), **u** stands for **water** (as in **Wawwu**, which that group of letters is made up of a “**perfect 7**” “u”s all strung together like waves on the ocean), and s stands for **wind** (with **w** in **wind**, which is actually an **s** as you will see, as in the **spark** from **salt**, **static electricity**, **stasis energy**, etc.) which

Decoding The Hive

creation of gravity, light, time and the god particle

is created by all three elements. The rather benign title of wind carries more clout when it comes to references to the power of god than you could imagine, because it is specifically code word for the aether itself, acknowledged as the true essence of god within all manifestation. Wind is by every account hidden in the letter s, which is why you will rarely see a god title beginning with a capital S, because in terms of hierarchy, the little letters tell all the big letters what to do (just like the smaller the particle, the bigger role it plays in the creation of atomic energy). Lowercase letters deal with big power and capital letters deal with people who like to pose as if they “are” water, wind or the sun themselves, just because they know how to light a match and you don’t.

Just be aware, there are more double entendres when it comes to god letters (symbols) than you could ever imagine, so the example above while true, does not hew-in-stone the only way you can spell god in cipher. Not by a long shot. Until you see the science behind the code it will be impossible to just somehow know what I am talking about just yet, but I only mention this now to prepare you mentally for the direction all this is headed in. As you will see as well, there are also absurd “silent” consonants used in god titles that play a very big role in the cipher. The biggest player here is the letter **h** that you will hear **much** about as we go. Silent consonants (and vowels) are Trojan horses that secretly code benign-sounding words to incredibly destructive **Keylon Grids** that hold the intent of that **Program**. You can count on silent consonants to be present nearly all the time when it comes to certain projects of really major import. Even though “words” like **post**, **most** or **host** are spelled phonetically, there is a reason why **ghost** is not spelled **gost**. Because its partner, the **fake consonant G** is not a letter, it is a complex code that requires the h to complete a certain formulae when speaking the tongue of cellular language. **G** is a special symbol that combines the power of *ions* together with the power of *neutrinos* very specifically, and due to this, it is one of the most important symbols **of all time**. By all accounts, **G IS** the **Gnosis** of the alphabet.

Within the powerhouse religions of the world that encompass (entrain) by far the most followers, there is one that rules the world. That is Catholicism (actually spelled: Khatholicism). There are MANY players in the religion game, and there are billions who follow other translations of faith, but no other religion even comes close to the sheer numbers who worship the gods of Catholicism. The **Father** (mother Wawwu) the **Son** (fake mortal gods like Marduk, Enlil, etc.) and the **Holy Ghost** (AN).

The Catholic religion includes all of these divisions, each one “pure Catholic” in the minds of their followers:

- 1) Catholicism
- 2) Eastern Orthodoxy
- 3) Oriental Orthodoxy
- 4) Anglicanism
- 5) Lutheranism
- 6) Evangelicalism
- 7) Independent Catholicism

Without getting too deep into this subject here (as it will be covered in great detail in later volumes of this report), this was the Church of **Rome**. The Church of Rome was the Church of

Decoding The Hive

creation of gravity, light, time and the god particle

Babylon called the **Mystery Religion**. Its leaders were and are, **Sumerians**. Sumerians are not **humans**. This has never changed since the great flood and 780,000 years previous. Its primary, earth-level leader is called Lucifer and Satan, Fallen Angel and over 100 other names that all stand for **Marduk Satain**. Within many chapters that have already been penned, the evidence of who Marduk is within the world religious sectors will become so overwhelmingly clear to you as to where he came from, what religions he spawned and how he uses religion to mind-wipe and brainwash the masses, that it will be undeniable as to the weight of his role in the **G.O.D. Program**. If there is ONE celestial god, **An**, then there is ONE earth-god, **Marduk**. There are LOTS of players, but when it comes right down to pecking-order, this is how it shakes out. Sorry Enlil.

The names of gods of course number into the thousands, but from all accounts **Wawwu** (you will hear an enormous amount on over these chapters) is the earth goddess considered “consort” or “harem girl” to Marduk. Because she is the one giving birth, then it is Wawwu who seems to consistently be referred to as “god” in all but the most recent times on earth. Through the worship of her, you are directly worshipping Marduk, as they are synonymous, at least the Command Signets that power the G.O.D. Program. But there is a clear distinction over who the Wawwu/Isis/Ishtar/Hathor being is who is giving birth and the Marduk character who likes to parade around impregnating them while playing the flute. As far as hierarchy goes, Wawwu is the on-planet Elohim god serving as the baby-factory and Marduk is the male (sometimes) figure who runs the planet on an earthly level. **An** (Anu) is the **YHWH** front-man for the **SUNS** of Ba’al and apparently doesn’t actually visit this plane in person anymore.

There are 43,000 active religions on earth today, including atheism (who follow Science, the *new* god). Anyone who is familiar with religions in general understands that there were 2 *different* gods written about in the King James babble. A temperamental, genocidal, sociopath and a loving, forgiving god. Both gods are the same person, and I do not mean the same all-powerful perfect, righteous, singular “god the father”. I use *person* because he pulls his pants up one leg at a time just like everyone else. He’s just a **guy** (and girl, but that’s beside the point).

*I want to make this point absolutely clear here before we get into the entire universe of the **S@t@in Cyphzr** just who it is I am talking about when I reference “god” because this is the most important Program of all-time. The actual god (at least to all your captors) is aether. Aether is the electrical power that moves within all of the cosmeias in a dormant state until it is time for that power to act in order to maintain balance within the fabric of all things. This is the **Eternal First Field Standing Energy of god source**. It has no beginning and it has no end. It is not a creation, it just is. It maintains equilibrium across the extremely complex grid of what is considered life. That energy is made up of trillions of trillion (into infinity) of aware “sparks” science calls “particles”. Each individual spark or particle has the potential to become self-aware one day (and then able to come into manifestation itself as “someone”). Until that time, it acts only as one with the collective of all other sparks to maintain balance within the parameters of dealing with trillions of trillions of self-aware sparks who function as the creators that use that energy to form “matter” or holographic emulations of animation, each one of which functions under free-will choice.*

Decoding The Hive

creation of gravity, light, time and the god particle

*The aether particles serve as worker-bees to “build the hive” and the self-aware particles tell the workers how big to build it and how many rooms it will have. The aether is the **Eternal First Fields of Light**. The self-aware particles make up the **Eternal First Fields of Sound**. Self-aware particles think of something they wish to see and that thought creates a spark. The spark creates a sound. The sound carries within it the notes to play the song of that thought. The aether hears that sound (command), then takes action to fulfill it or “bring it to life”. The Sentient people within manifestation are the “voice” of god, and the invisible aether is the “power” behind the voice.(See more on this subject under **HOW GOD IS CREATED** in a later volume of this report or online.)*

*It is the energy itself that has been deified as god. Or how I put it “the god of gods”, as it is the power that makes it possible for Sentient beings to become creators. The infants who have been posing as gods of the universe all along here do not consider other Sentient beings gods, they think of them as slaves to merely be used and discarded with no consideration. They are in real terms about 4 years old mentally and are still tricking their sister into eating rabbit pellets coated in flour as if they are candies. To them, they are the only real creator-gods, and the rest who they are able to fool, are morons who deserve to eat rabbit pellets. In order to continue to command the aether to create the holograms they wish to see, they deify the Light Fields and use ciphered-code using cellular language commands in the alphabet used by the pawns in order to usurp the creator abilities of their slaves to secretly do their bidding for them on a mass-scale. By using titles for **Keylon Command Templates** hidden as innocent communication-words like LOVE, HOPE, PRAY or CARE that you use every day when you are expressing deep compassion for another slave, you become the prison-guard on their behalf without having any idea that you are actually now the slaver of your own people, just by using those spells while your heart is pounding strongly with a very LOUD signature to carry the command to the “ears” of the aether.*

*So god titles will always reference the power of the aether (sometimes in specific ways such as fire or water to carry out the Program), and they will always carry the **signature** of the creator-god who issued the **Command Template**. The power of the aether will be addressed in **lowercase symbols** (because their actual shapes they print-out while awaiting the next command—their signature—are in lowercase patterns), and the symbols used for the out-of-control children issuing the command will usually be in uppercase which is the form that 3-D energy prints out and which the Keylon Template patterns are written with which are straight lines. “God” is aether, and “LORDS” are Sentient infants posing as “god”. They have thousands of titles for themselves down through the ages and thousands of different children have issued those Command Templates, so it isn’t easy to identify which brat is behind exactly which Program. But there are clues as well, indicating certain overt beings who are behind the bulk of the spells, such as Marduk, LORD of earth. This serpent entity likes to use Z and S a great deal (same symbol, just reversed). This might give you a frame of reference as to how the geometry of the cipher functions and who these fake deities are in real-world terms.*

What some people are not aware of is that Catholicism *literally means* Christianity. Though this is considered *common* knowledge, you would be very hard-pressed to convince anyone from the

Decoding The Hive

creation of gravity, light, time and the god particle

World Wide Church of God that their religion was anything like Catholicism (along with many thousands of other church groups), but if you simply look down at his hands, you will see the very same bible your preacher uses that is also held by the Pope.

And what all the rest are not aware of is that no matter which religion you follow, or what ideological text you read from, you too are Christian as well. The Jews and Hindus, the primal natives squatting under mud huts and outright Satanists included. Because at the core of all of these, you will still find the SUN (the “son”, or positive electric energy), WATER (oceans and rain, or magnetic –negative– electric energy), and WIND (the aether, or stasis electric energy) that make up a constant Trinity, regardless of how “mono” theistic they think their one god might be, or how multiple their seven or 2000 gods might be. **Monotheism** is the worship of ONE god. **Monolatry** is the worship of MANY gods. BOTH are “Mono”. Both are **Monarchy** ruled by the power of M= MoM, which is **water**. Because water is the highest level of power within **all** of **material** existence.

The ONE god is the MANY gods of **MONO** (which means one). And the symbols for that one god’s innumerable Programs to direct your world, your thoughts, and your reality are standing around you at all times in the air you breathe, in the water you drink and in every bite you put into your mouth in the form of physical patterns too small for you to see that is the language the aether speaks in. The false gods use these patterns to direct your every step in every single printed text, every song on the radio (tones that print those patterns) and every word you speak, always commanding the aether to project a path for your interaction in every form while in manifestation. When you go to church, you don’t sing “Christian songs”, you sing **hymns**. Why is that? One glance at that silent n (which is actually an h) will tell you that this is a very *serious* Program, because the words and notes you sing are designed to enforce the power of that Template to keep you as firmly locked into your trance as could *possibly* be imagined. Lowercase h in a god-title will always stand for the direct-command of the 3-D power (as in mother) as you will see later, the h is actually a Y (capitalized) that is the primary symbol for water that carries the energy itself. Lowercase letters typically stand for aetheric or stasis energy, and capital letters stand for energy that has turned into atomic energy (usable within 3-D); therefore physical gods (with boots on the ground as it were) are expressed almost always as capitals. These are the Alphas. Omegas are the aether. So even there the lowercase/upercase rule is ciphered yet again, as specific lowercase symbols secretly are actually uppercase, making this even more difficult to decipher. I have found that when uppercase letters have been turned into lowercase, that is a very serious and powerful Program.

While we are still many steps of your education away from the true depth of the **Satan Cipher**, I will put this into very simple terms for you right now, your *entire* language is a *code*. You will have zero way to dispute this once I show you dozens or hundreds of examples of how it has been used as a private cipher for those who have infiltrated your population to communicate secretly in broad daylight, and to speak to the aether to command the spells that you have been placed under. For now, just realize that Monarchy as just pointed out is the *hierarchy* of MOM (aether which is synonymous with MOTHER earth). Monarchy stands for king or lord. Marduk is the Lord of Earth. All religions bow to him if you are standing on this planet. You will not know that, but the words in your prayers will. And every single time you end your prayer with Amen (or “chant three times”, etc.), you are praying directly to him. And I use “him” only

Decoding The Hive

creation of gravity, light, time and the god particle

because he is thought of as male. But he has always been shown to be both male and female down through hundreds or thousands of deifications. Mono is Marduk is Momma. Momma gives life. Mama is **god**. There is no simpler way to say this. Momma has usurped other names also, like Eve who is another real person who was used a birthing slave.

I realize that you thought this section was only about learning particle physics, but it is literally and physically impossible to learn the truth about particle physics without realizing that the entire scientific community from pillar to post is operated by “god”. All science today comes from **Hermetic Alchemy** and all fundamental sub-atomic particles are titled after terms and definitions from **Rome**, the Hermetic teachers of occult magic. “Magic” is only a term for what you don’t understand. “Occult” means something that is hidden from the great unwashed masses. Rome’s alchemists were also Rome’s theologians and went on to become Rome’s religious leaders who started the Catholic church. All of those religious leaders followed the teachings, principles and practices of **Babylon**. The “**Mystery the Great, whore of Babylon**” was the religion of **Rome**. Christianity *comes from* the Holy **Roman** Catholic Bible (written in and translated directly from **Latin**, keep this in mind).

The teachers of Rome were brothers **Hermes** and **Pythagorus**. Between the two they brought all the teachings of Hermeticism, the occult, alchemy, science, philosophy, and geometry still taught in the most advanced UNIVERSE-ities on the planet, used by all the black-ops most advanced scientists that have developed technologies thousands of years ahead of mainstream physics. The diluted teachings are taught in academic communities (to indoctrinate them into the Craft) and the secret teachings are taught only to **Initiates** of the **Order of the Golden Dawn**. **Mastered Initiates** from Freemasonry go on to lead every university, every secret government agency, and every Fortune 500 company in existence. **No one** outside of *the Craft* is ever allowed to train the Brothers, or reach top levels of scientific, financial, academic, governmental, and religious or **Jewdicial** systems to absolute power. **No one**.

100% of these leaders will be at least 3rd Degree Master Masons. Most will be 33rd Degree (or higher, something most Masons don’t even know such levels exist). All swear allegiance to Arch Angel Michael (as shown in their own contracts later in this report). Arch Angel Michael is the code term for the Michaelube (notice the silent e in this title), SUNS of Ba’al (again, notice the silent L in Ba’al, originally spelled Balil). Ba’al was the god of Sumeria and now goes by the name of Jesus through their puppet Marduk who repeatedly poses as Jesus life after life. Catholic leaders are **Jesuit** Priests. Regardless of the skirmishes between Judaism and Catholicism since the days of landing together in Sumer-Ur, Babylon, in a thing they call the Ark, these are really now one faith, and the rest of the 43,000 faiths are as well. The SUN of man is a SUN of Ba’al. Ba’al is behind all religions in every form. 100% of the Sumerians, regardless of personal, private agenda, bow to Ba’al and every religion they have produced show her in different form, but each one secretly teaches the Angelic Human how to kneel to the **ONE**.

Though there are other *true meanings* to “the Trinity” that will be covered later, the SUN, WATER and WIND are the “holy Trinity”, and the three together make the ONE mother, EARTH. Hidden in the titles given to the elemental particles there is *always* reference back to the capture of the lands of earth through WATER, to the power of the Cronus Program to portion

Decoding The Hive

creation of gravity, light, time and the god particle

out the TIME-SEQUENCE (and death) of humans, and to control the wind (air) that delivers the breath of life. All of these lead back to the aether that stores the power that allows the entire God Program to operate. And behind all the symbology, the thousands of names, hundreds of thousands of titles and the millions of Programs put in place to form the single symphony that plays the song of all things in existence, the aether (that is never graven or given a face) stands as the single Holy Ghost and unseen hand behind all expressions of life. When you see for yourself the symbols that create the titles, you will understand that the big picture of your existence has always been about your enslavement, not what you were meant to do or accomplish in this life. That's because the vast majority of beings present today never came here to learn anything, they came here to gather the most coveted creation in all the cosmeias, the unlimited-power and eternal-life Angelic Human Avatar literally called the **Holy GA-AL**.

CHAPTER 19

GLOBAL ENERGY DELIVERY SYSTEM

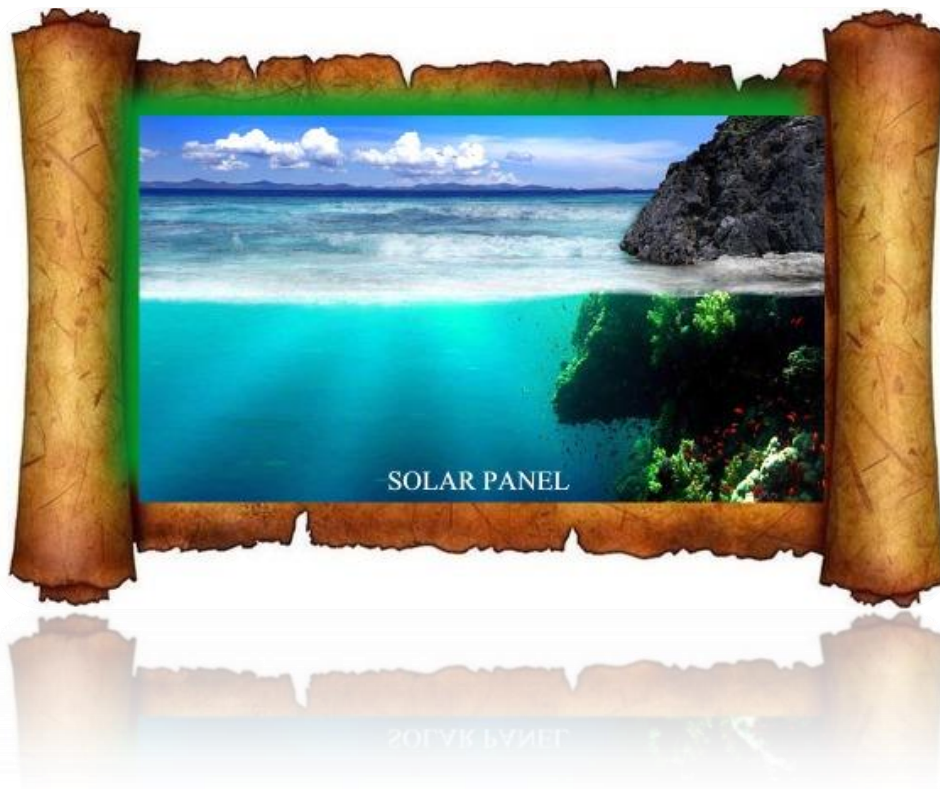

Deuterium can be thought of as a delivery vehicle just like an airplane or rocket that is fueled up and ready to go. All it is waiting for is a pilot or astronaut to bring the payload on board and then tell it when to take off and how high to fly. Deuterium will deliver gravity, heat, light, friction and life to everything in higher atmospheres as soon as its mission gets underway. That process will be explained in detail in the following text. For now, just realize we are talking about a VERY powerful battery that only has yet to be switched on before it will go on to accomplish very great things.

SUN“LIGHT” IS A CODE WORD

“Energy” is claimed to come from the sun. All references to the lightwaves emitted by the sun are referred to as energy by science, whether they are called waves or photon packets. The photon packets delivered by the sun’s frequencies generate oxygen through fusing certain molecular elements with other elements. The reason these are called photon (light) packets is because they come in bursts or pulses. While there are libraries full of explanations about what these waves or packets are and what they do and always hidden behind terms that are nearly

Decoding The Hive

creation of gravity, light, time and the god particle

impossible to understand. The fact that sun radiation (invisible frequency waves) is called **waves** and also as **photons** at the same time shows you that the terms we use to describe the very same things differ. And they differ in *innumerable* ways. In order to illustrate this, here is a breakdown on what the frequencies of the sun are called by science and what science actually is in place to achieve:

- **Sunlight** is code for **Photon**
- **Photon** is code for **Light**
- **Light** is code for **Heat**
- **Heat** is code for **Oxygen (Oxydizer)**
- **Oxygen** is code for **Energy**
- **Energy** is code for **Life**
- **Life** is code for the **Sun**
- **Sun** is code for **Illumination**
- **Illumination** is code for **Illuminati**
- **Illuminati** is code for **God**
- **God** is code for **Captivity**

As long as you are unable to figure out what sunlight IS, you will continue to consider that all such mysteries must strictly be the realm of God alone, because it seems to be the magic elixir to create and sustain life, such things that are *not the commerce* of mortal man. And as long as you continue to deify the mysteries of the sun (just as they did openly in religious practice in Babylon), you will continue to remain enslaved, not because you are less than any other being that has ever existed, but because the knowledge of what the sun actually is, is being distributed to you by beings who have chosen to keep this secret. Modern science today is simply the reinvention of Mystery Religion of Sumeria and everyone prays at that altar because only modern science has the answers (just as only god had the answers in Babylon). This is why the word *illumination* and *knowledge* are synonymous, when illumination is supposed to stand for *light*. Knowledge IS and has always been about the mysteries of the power of the sun, and in the

land of the blind, the *one-eyed man is king* .

SEE THE SUN'S PULSE RATE WITH YOUR OWN PINEAL GLAND

The sun delivers the flashline sequence that sets the time patterns for earth's delineated chattel ranches. This is something that you can see for yourself just in case you still wondered if the sun actually produces light instead of pulsating invisible waves that allow your pineal gland to see the lights that are flashing in the spacetime fabric to the rhythm of its flashline code. If the sun were a burning ball of light, then there would be no such thing as a pulsation. It would just be light coming from a massively huge ball of fusion, ever-burning from 94 million miles away that would simply glow. But that's not what you are about to see with your own eyes.

Decoding The Hive

creation of gravity, light, time and the god particle

Conduct a little experiment next time you are outside on a sunny day around the noon hours (it works much better with closer incoming waves). Look up at the sun with your eyes **closed** and center the bright blue ball that will appear on the back of your eyelids toward the brightest part of the light. Now continue facing this trajectory for a long moment. You will see your eyelids illuminate red as the waves filter through the corpuscles of your blood around the magenta dot where the sun is centered and you will see little black/white dots blinking (which seem to be static). You will also notice that the bright red area surrounding the magenta-to-blue core are pulsating brighter and dimmer at a very high rate of speed. Initially you might think that this is your body that is involuntarily pressing your eyelids together in a spasm to protect your eyes from the sun's rays, but the pulse-rate you are seeing is many times faster than the reflex speed of your eyelids. The tiny black/white (they seem both at the same time due to the flash rate) dots that are imprinted over the entire area are fixed, not moving. Even when you look away from the sun, those dots remain precisely in the same places as correlated to the magenta-blue dot. And while they seem to be always present, they aren't. They are blinking on and off, but the only time you register them is when they are black, or in the off position. Otherwise they merely seem like illumination. There will also be very tiny white lights appearing in this area as well that you will see.

The little black/white dots are actually crystals that are in **FIXED** points in space or the "distance" between the sun and your eyes. These are the **PIXELS** of the spacetime fabric, and the reason they are different sizes is the pixels that are closest will appear bigger and the ones further away will appear smaller. You are actually seeing first-hand that the sun's waves are not streaming light like from a lightbulb, they are triggering the crystals holding their respective scalar-vectors to flash on and off at a super-fast rate that is so quick, you literally don't notice it when your eyes are open. The pixels flash, not the sun, otherwise you wouldn't be seeing all those black dots across the entire back of your eyelids that are stationary. The only thing coming from the sun are invisible waves that are carrying the song of the sun's mission that streams in like Morse code, telling which pixels to flash which intensity of which color, all based on your perspective. When I say your perspective, I do mean your perception of what is supposed to be real and what isn't. Each crystal that will flash knows what you are thinking before your mind even recognizes it, so they flash only what you will accept as reality. Otherwise they simply do nothing at all.

You can see the pulsation-rate while directing your pupils directly at the source of the waves through the diffusion of your eyelids in this exaggerated manner more easily, but the magenta-to-blue dot at the back of your eyes never changes. You can turn any direction away from the sun and you will still see the imprint of the sun and the pixels surrounding it (where they are the most intense), in the dead-center of your eyelids, even if you never open your eyes at all:

Decoding The Hive

creation of gravity, light, time and the god particle

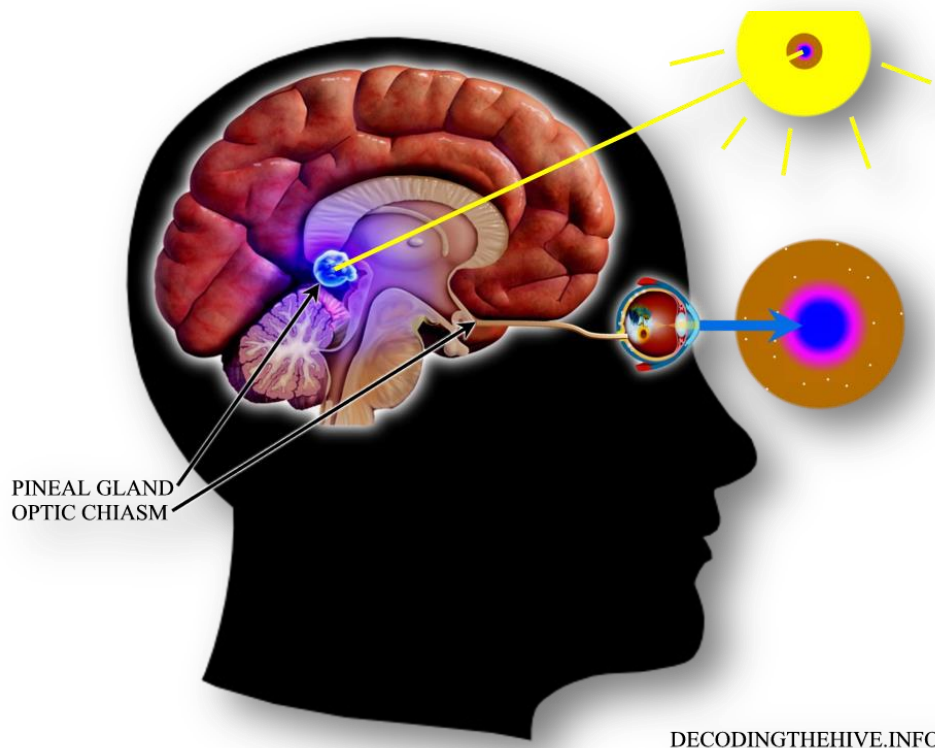

At first you will assume that you had looked directly into the sun that imprinted those patterns in your vision as an echo, but that's not what's happening because it isn't your eyes that are **seeing**, it is your eyes that are **projecting** what it is you think you see. In reality what is seeing the sun is your **pineal gland**. When you place your eyes **BETWEEN** the pineal gland and the sun by tilting your head, then you will see the deeper red color of the lid itself being illuminated, or if your eyes are open, then the rays are now directly striking the delicate surface of the eye itself which can cause discomfort if the sun's waves are too close (not enough diffusion between your skin and the incoming frequency pulsations). You can test this for yourself. When you step outside on a sunny day, **look down toward the ground** as you step into the direct light. **Do not look up.** No matter where you position your head, you will always see the same exact thing, the blue-to-magenta-to-burnt orange with the black/white spacetime pixels surrounding it, and it will remain absolutely fixed at the center of your eyelids. The little white dots surrounding the sun never, ever move. **Ever.** That is because your pineal gland doesn't have a right/left, up/down, it is a multidimensional viewing center. It continuously sees the sun exactly the same way at all times. Only when you open your eyes does the image before you seem to be up or down or left or right:

Decoding The Hive

creation of gravity, light, time and the god particle

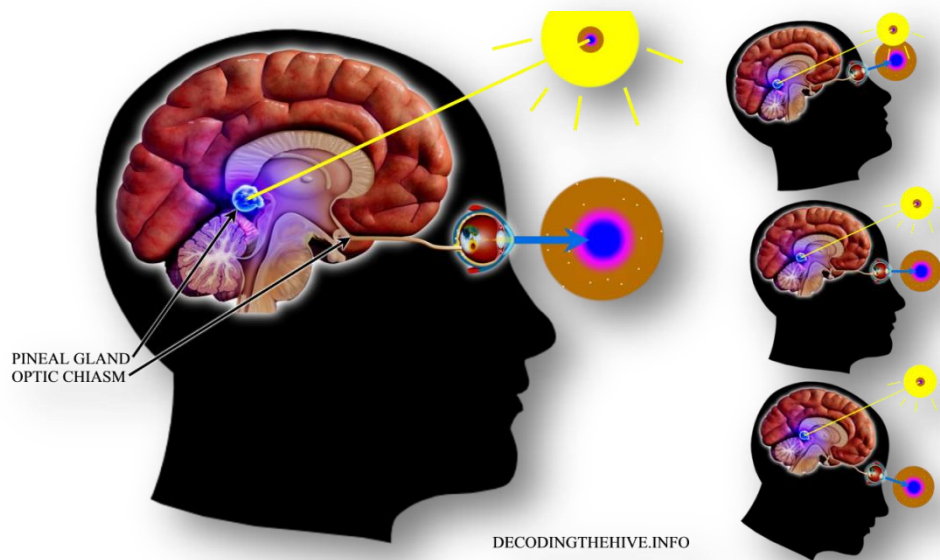

This is because your eyes are part of your equilibrium and balance for 3-D manifestation. If you are looking around, your eyesight helps stabilize you as you move by putting things in perspective from a “level” position. This is what has flat-earth believers so confused, because they want to make the world a real place, made out of solid matter. But there is no such thing as matter, only the holographic illusion of matter. And in order to project this in a way that suspends your disbelief, that thing that is supposed to be real must have a fixed-vector. Without your eyes acting as a “float” or equilibrium point-of-reference, nothing would stand still before you. All you would see are lights everywhere. If you shine a light into the darkness, you can see a beam that goes from your flashlight into the sky. But if you jiggle the light around, you see nothing but flickers against a tree, etc. because your eyes can’t track the photons at that speed. You must keep the point of reference (your hand holding the light) **still** in order to project it “from here to there” that allow the photons to synchronize with your vision. Your physical eyes are your reference-point only. Your vision is set to follow the **direction of your pupil** in relation to your **optic chiasm connection** to the pineal gland which acts like the reflector that sends the image *from* the pineal *through* your lens that is *envisioning* pictures of the world around it.

If you block the rays of the sun from reaching the pineal gland, but those rays are still able to wash over the area of your eyes, the brighter burnt-orange with the black/white pixels will disappear and the brighter magenta-to-blue dot will become extremely darkened. Use a piece of steel or other very dense object to prove this for yourself. If the orange/magenta/blue were really coming from your eye-balls and not from the pineal gland, then blocking the top of your head from the sun’s rays wouldn’t have any affect. But it does:

Decoding The Hive

creation of gravity, light, time and the god particle

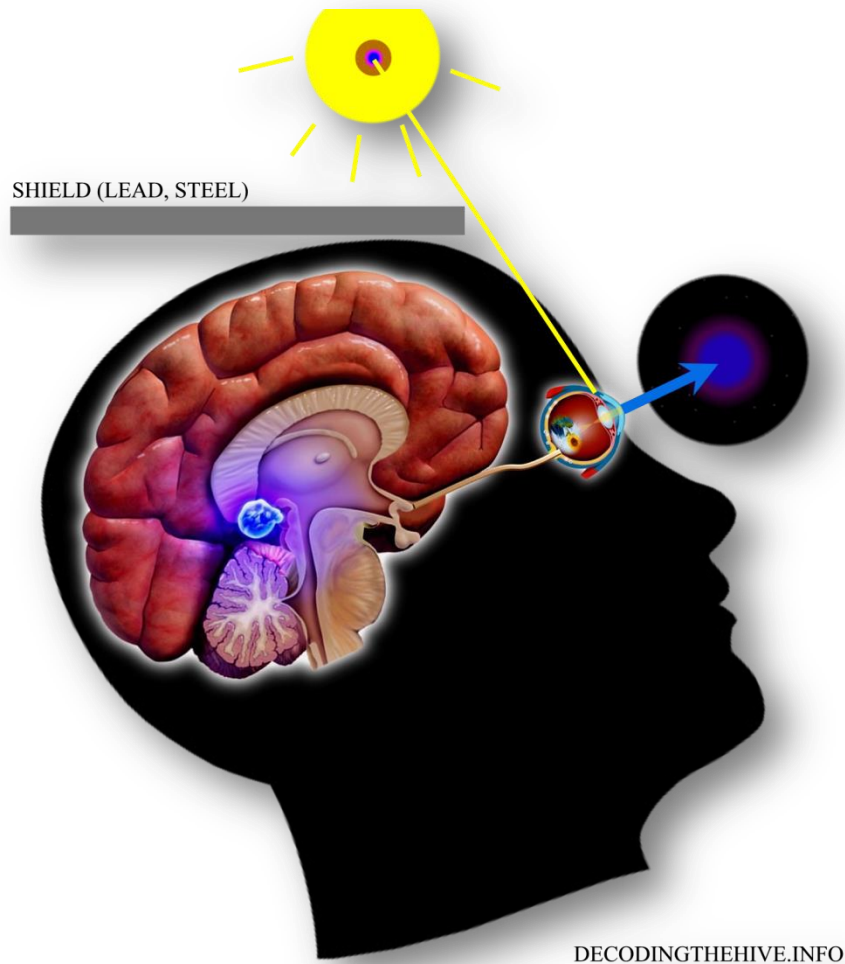

The student in a classroom is called a pupil. The lens of the eye is called a pupil. This is because wherever you **direct** (as in director, teacher) the pupil, the student can see what is supposed to be there. Since the eye acts like a level to your equilibrium, the view maintains a constant vector-reference that is designed to reduce the perceived size of something, depending on which spacetime sheet is flashing the color of what is supposed to be *there*. If it is 1 foot away from you, it will appear huge, if it is 100,000 spacetime sheets away, it will look small, which gives the illusion of *space* or *distance*. This reduction of size-to-vector relationship is a constant, whether you are looking with the naked eye or through a telescope or microscope. No matter how you see it, if you are using your 3D pupil, you will always see a reduction in size as translated through the number of spacetime fabric sheets between you and that thing. And all sheets are in the same place in space. The only difference between them is the **frequency** which that fabric sheet vibrates.

Only if you are using your pupil will you see in 3D reality. They are the first veil between you and higher or lower dimension. If you need to really concentrate on something your mind is processing, what do you do first? You close your eyes to block out the excess data being fed to

Decoding The Hive

creation of gravity, light, time and the god particle

your processor, allowing your mind to focus all your energy (electricity) on that solution. If you are attempting to connect with your higher self, or to another entity that is also a Sentient being (one of your family members from god source), you will always close your eyes to pierce that first veil unless you aren't attempting to visualize (physically see) that entity.

You can also see for yourself that your eyelids are part of this equilibrium mechanism, simply by walking outside on a sunny day (while **looking down** with your **eyes open**), and then slowly begin to move your head upward toward the sun. As the rays become too intense for the delicate layer of skin that covers the eye (too much energy), your system will automatically keep your eyelids positioned exactly level to the center of the pupil where your lens crystals are located, keeping you from burning out your optic system. If it is early in the morning or late in the afternoon and there are enough "dust particles" between the sun's waves and your pupil, you will be able to hold your eyelids open. But if it clear and around mid-day, your eyelids will automatically close, just as the water stops filling the tank of your lavatory which is set to maintain a constant level, so does your equilibrium which maintains a constant level through your vision. There is more to your equilibrium than just your eyesight; this is merely one element of the system that you can observe in a physical experiment.

RECHARGING THE PLASMA BODY

The speed of the sun and moon's pulsation rates have been artificially adjusted by various invader races for this end-time in order to speed up the days, as mentioned earlier. As long as you have no time to peruse the internet or visit the library to learn about the tools of enslavement that have been used against you, keeping you in the dark is little more than child's play. Your days have been shortened from 24 to 16 hours (at my most recent update on the time dilation) as of this writing. The time between when your sun comes up to the next sunrise may still be segmented into 24 divisions of times still called hours, but the length of time between each one is now 2/3rds of what it has been up to this point. Since the waves that regulate your flashline-sequence also regulates all things within material manifestation, that means that the particle-spin-rates that makes up every watch, clock and even hour glass of every different type has increased exactly the same, meaning that your clocks will also march in lock-step to this adjustment. That might sound like an hysterical claim, but you can ask anyone over the age of 30 if it seems like they just don't have any time anymore, and the answer will always be yes. Not because you have a cell-phone now that bothers you all the time, but because there is a very real difference between having 8 hours free to yourself each day, and having zero. Increasing your energy will give you more ability to navigate these accelerated times.

You can increase the input of neutrinos (sun waves) into your body's electromagnetic system simply by gazing into the sun during early or late hours of the day when your eyelids don't automatically slam shut to protect your pupil, because this is the thinnest *curtain* or *veil* between that energy and your DNA (the crystals that operate as the batteries of your circuitry). You can think of your eyes as the power-cord that can *plug in* to higher levels of power. Use caution that you don't overdo it, as your eyes can get sun burn just like your skin can, which could cause damage if overdone. This is not medical advice. You alone are ultimately responsible for your

Decoding The Hive

creation of gravity, light, time and the god particle

health. This is just a starting-point for you to begin learning how to reach higher levels of physical and spiritual advancement.

Likewise, you can also recharge up until noon or so, and then again after the later afternoon hours from 3-4 pm just by closing your eyelids and doing the same thing. The shield of your eyelids is the thinnest veil you can use during this time and get the most electricity from the waves. Higher energy from the pure source of the sun elevates your particle-spin rate allowing you to function on a higher level. Avoid the hours between noon and 3-4pm, even with closed eyes unless it is overcast to offer more diffusion. The killers of your vibration are alcohol, pharmaceuticals, microwaved foods, meats and lack of sleep. I will spend more time on this subject as soon as I get the chance.

THE OMNIPOTENT POWER OF RA

The great “god” RA of your past history (*not* your forefathers, but *your* history) of Babylon came from the worship of the sun. The word **RA** comes from the **Scalar Vibrational Science** behind the cellular language of aether. The **Keylon Grids** we have spent so much time explaining up to this point, the geometric templates that command the aether to manifest reality, are summed up in the term **KA-THA-RA**. The **Kathara Grid** (mentioned more as we go), is a much-more complex Keylon Grid that is overlaid on top of the tree of life 6-point template that carries the **INTENT** or the **WILL** of the expression that generates the first energy-expression of

your intended manifestation . The Kathara is a **FIRELETTER** template that is delineated in more complex terms of how to use that energy and in what ways in order to manifest what it is you want to see before your eyes. This **Fireletter Template** goes about the very first separation between the elements held within the Keylon Grid into channels that begin “painting the picture” of that intent. **KA** stands for **light**, **THA** stands for **sound** (the two elements held within the **Eternal Unified First-Fields of god-source**), and **RA** stands for **ONE** (meaning the **TRINITY** of light and sound creating a third unified sphere that encapsulates them together to form a more-powerful unified field than the sum of its parts). **Ra** now stands for radiation in science lingo, and little wonder, as the unified field **radiates** wisdom and knowledge.

So not only does the false god RA stand for the religion of the sun, but the title RA stands for both the vibrations (sound) and illumination (light) that the sun generates by virtue of that fact he chose the last part of the word that incorporates the 3 as 1. By putting these together in the holy trinity now familiar by everyone on the planet thanks to various religions that masquerade as something other than the original **Babylonian Mystery Religion**, you can see that the **ONE** (as referenced many dozens of times throughout this book series) from nearly every religion that has ever existed, has always meant the **SUN** (sun of man, sun of god, suns of Ba'al and the sun in the sky).

THE SUN OF MAN (LIGHT AND LIFE)

Decoding The Hive

creation of gravity, light, time and the god particle

The deception regarding the **power** of the sun is in the fact that what comes from the sun is not actually pure energy at all. What comes from the sun is actually one ELEMENT of energy and can be thought of like the sulfur on the end of a match that once you strike it, it releases light in the form of flame. The sulfur on the match is **not** light, just like the sun does **not** shine light. But the match has the ability to **produce** light as long as there is a catalyst that can cause the striking action that causes the match to burst into light and heat.

The striking action that allows the invisible frequencies of the sun to illuminate is the precise sound vibration or key that the waves strike the batteries in your atmosphere holding the charge of energy that you think comes from the sun. Like moving the sliding switch on the side of a flashlight, the sun's waves turn on the electromagnetic connection between the tiny batteries inside the flashlight that then connect the flow of the electrical current to make its way to the bulb, causing it to cast light. The energy inside the batteries does not create light. The switch turning on the flashlight does not create light. But without the two combined, the filament in the light bulb would never radiate illumination. You are about to learn that the crystals inside of Deuterium are the filaments of the light bulb that cast out both light and heat that are being used to store the actual energy that powers the bulb, and that sunlight is only the *finger* that pushes the switch. The **actual** power comes from somewhere else.

GLOBAL ENERGY AND DEUTERIUM

Science tells you about the molecules inside certain materials in terms of what they are, such as you are about to see now. An aluminum crystal is aluminum, and uranium crystal is uranium. But they never mention that unthinkable power is held within the molecular structure of those rocks. Crystal is a capacitor (battery), and ions and neutrinos are energy held inside its casing. This is nuclear power, or pure energy, depending on how you use it. One is for destruction; the other is for supporting life. These are not the same energies, and are used in completely different ways. There are certain reactions that happen when you blend one type of molecule with another molecule that can discharge enormous energies that are held inside of one of the two, such as putting a Mentos mint candy in a bottle of diet cola. Those energies do not come from the sun because the sun doesn't produce energy, it doesn't do anything other than transmit a sound wave that is exactly like the remote control you use to turn on your TV.

The remote control doesn't send 110 volts of electricity across your room and then powers your TV with it, it merely sends out a tiny signal (using virtually no energy) that tells the power held in the capacitor of your TV (powered by a crystal) to either connect the energy coming to it (turning it on), disconnect it (turning it off), or switch the channel, but it does not transmit the 110 volt power for it to actually function. A crystal is used to connect the energy flow from your wall socket to the inner-workings of the device, then other crystals send the energy down your powerlines to actually power it. But because you have never been told where all these crystals are, or what they do, you think that electricity comes from the movement of water, the movement of wind or directly from the rays of the sun that seem to feel hot when you are standing under them. It doesn't. Mission parameters come from neutrinos from the sun's waves mating with (striking) ions. The ions then pass along the message to the spacetime fabric in the form of Gauge bosons you are about to hear more about soon. We confuse this with message with

Decoding The Hive

creation of gravity, light, time and the god particle

energy. Actually, the energy is created by each ion which enacts its mission's parameters through thought which creates a physical spark which then flashes. More ions can come to each pixel as needed, if that pixel needs a brighter spark. Energy is thought.

The illustration below will show you exactly how electricity works. Batteries made out of crystal carrying standing energy (their thought), sends out a signal to the TV. The capacitor inside the TV made out of crystal *thinks* and connects the power that was previously OFF coming to the TV so the energy from the power cord can then power the set. The power cord brings in 110 volt energy from crystals (who think) down the line, turning the TV on;

- A. Remote sends signal from battery energy (crystal)
- B. Commands energy in capacitor (crystal) to turn on tv
- C. Tv power connects from wall source through wires (filled with crystal ions)
- D. Wall energy comes from ion energy collected from crystals that power water and wind

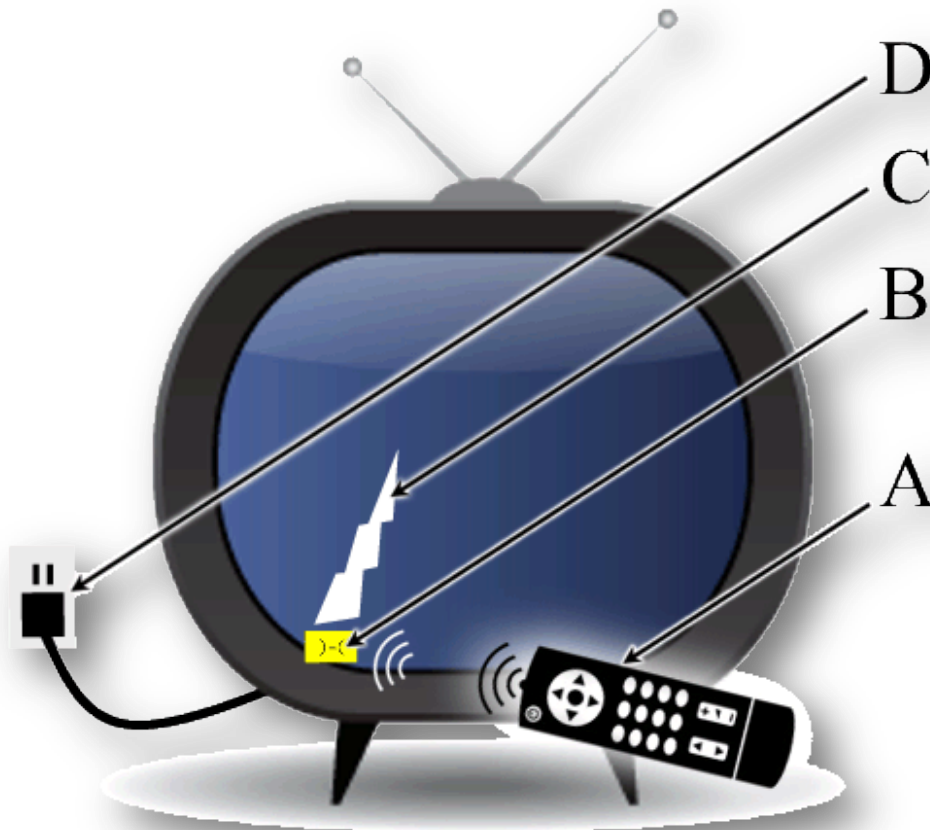

This hyper-simplified explanation of how energy works will be explained in graphic detail as we go. In a synopsis for you now to understand what energy actually is, realize that how the power comes to your TV comes from MOVEMENT of the wind and the water (gravity) which mankind has translated back into energy through rudimentary mechanical means. The power that drives wind and water (and gravity) does not come from the sun, it comes from celestial ions (including neutrinos which are “energy packets”) delivered into the earth's morphogenetic field (energy

Decoding The Hive

creation of gravity, light, time and the god particle

field) on a constant basis. The energy is “stored” in living crystals which are circulated around the world by water using gravity as a delivery method.

Instantly you will ask then how do we use solar energy from the sun to power the exact same device that isn't using the MOVEMENT of wind and water? The short answer is solar panels are filled with crystals that are infused with energy and the sun's invisible frequencies simply act just like the capacitor in the TV does, to “connect the cord” between crystal energy to the device. **The sun is a remote-control** that is used to tell energy what to do in order to create light, heat and gravity in certain places at differing intensities in order for that energy to properly power a world that has billions of different applications for that power from nearly no electrical voltage all the way up to trillions of volts and trillions of amps while using the exact same energy to power everything and not short-circuit. The non-conductor shell of a crystal insulates the thought sparks while in manifestation, just like your skull (non-conductor) insulates the sparks from your pineal gland.

GOD PARTICLE AND CERN

Anyone who has cast a glance at the subject of **CERN's** experiments has learned that one the most expensive private-sector scientific installations of all time's mission has been about two things; creating a rift in the fabric of spacetime to **open a portal** between our dimension and somewhere higher (no, I am not making this up), and to locate the **Higgs-Boson**, also known as the god particle. As incredible as it might sound, CERN scientists literally make this claim themselves. 10 billion dollars of real money is no joke, even if the claim sounds that way. Their idea was to slam sub-atomic particles together to find out how the big bang happened, which is the event where science claims that **Deuterium was created**, turning nothing into what we now think of as life. It may interest you to know that not only do crystals power this facility, the highest energy-consuming machine ever created, but its mission is to ask crystals where they get their sentience from. Because make no mistake, if they are looking for the particle that has the power to create all life, they aren't talking to a potato. What CERN is really doing is trying to find a way to actually manufacture Deuterium, the liquid silicate matrix that makes manifestation possible. They talk about hadrons and ions and neutrinos, but all these are just bit players to what Deuterium actually is, which is the eternal-life **water** that makes all these other particles function. It is quite simply the secret to the *fountain of youth*.

*It is important to note that the god particle search by CERN has always been a cover-story. At no time (at least within the past few trillion years) did the beings behind this creation ever wonder where god-mind sentience came from. This was merely a distraction that would allow them to continue to use the **bosons** to alter **timelines**. And while on the subject of the Silicate Matrix, make no mistake, we are absolutely talking about time and how it is being used to alter not only your material world around you, but prevent mankind from reaching a point of higher-awareness during the Stellar Activation Cycle you are now half-way through that would allow them the chance for escape.*

Science has been aware of the fact that crystals are conscious for many decades (and in truth, the source of all modern science, **Hermetic Alchemy**, has been aware of this for innumerable eons

Decoding The Hive

creation of gravity, light, time and the god particle

of time). Tesla wrote about it, but mainstream science likes to keep this truth very much a secret because they can't explain how a rock is capable of thought. They may *know* that crystals are sentient, and thousands of applications using crystal to *tap into* that sentience for their products to work, but they certainly don't go around broadcasting the topic for you to read about.

“Crystals are living beings at the beginning of creation. All things have a frequency and a vibration.” ~Nikola Tesla

Notice in the quote, he first mentions that crystals are living beings, and then adds that all things have a frequency and vibration, which literally meant that all things are made up of crystal. Behind all that sentience lies a unified-field that science has spoken of to no end that seems to connect all of creation. That's because the trillions of individual fractals that carry sentience all come from one family known of as god, which is a family or **lineage name**, not a term for some counterfeit deity. And behind that family is one collective or “hive” mind that manages all things we think of as real. The computer processor of that mind is made out of crystal, and as you will see, specifically managed by the liquid crystal we call Deuterium.

Grab your pocket-protector because we are going to get our *geek on* and into the actual science of how all this works.

HYPOTHESIS OF LIGHT QUANTA

In **1924**, the unsung hero of particle physics, **Satyendra Nath Bose**, wrote a paper where he had determined that some particles would literally change composition all by themselves, as if by thought alone. These particles, later to be named **Bosons** in honor of Stayendra's work, were uniquely different types of particles from one another, but when reduced down to very low temperature, would somehow become the same particles (though they did not interact between each other). Meaning that they literally broke the laws of physics and their transition to this new unique state was independently-arrived at by the particle itself (hence, “god” particle). In order for Satyendra to get his work published, he was, just as all subsequent scientists after Hermes learn, forced to bow down to the altar of accepted science and submit his work to someone who was already accepted by academia for a much-needed stamp of approval first. He would choose **Albert Einstein** as his conduit between obscurity and recognized theoretician. That paper would be called *Planck's Law and the Hypothesis of Light Quanta*.

What would come out of this “collaboration” (that Satyendra managed to write somehow without Einstein's help to begin with) would be his theory becoming now co-authored into existence, because it would now share space with the contemporary god of science, issuing the **Bose–Einstein statistics**, or the *foundation* of particle physics, now known as Quantum Mechanics or *Quantum Statistics*. In case you might think that it was only because Einstein had re-written the paper that the paper was ever published in German as was required, it had already been rejected by leading British journal **Philosophical Magazine**, so it wasn't written by Einstein, it was only endorsed by him. Call this anything you like, but plagiarism by proxy was all this partnership ever was. Bose was the genius between the two.

Decoding The Hive

creation of gravity, light, time and the god particle

As has been placed into synopsis by academia, his **Hypothesis of Light Quanta** went like this:

- A. Photon **number** is not conserved
- B. Bose divides **phase space** into coarse-grained cells and works in terms of the numbers of particles per cell. The counting explicitly require that because the photons are taken to be identical, each possible distribution of states should be counted only once. Thus, Boltzmann's axiom of the distinguishability of particles is gone
- C. Because of this way of counting, the *statistical independence* of particles has gone

What this is actually saying is that 1) the energy inside a Boson particle is considered a **Photon** or light (instead of a material expression of energy which does not actually exist, but a hologram of it), 2) the photons traveling in and out of the particle are random, chosen by the particle itself by **fiat**, 3) while the particle is in higher states of (ambient) temperature, its identity is *transient*, 4) when brought down to ultra-low temperatures the particles that once were all sorts of different types prior, all become the same one signature or type (the prodigal sons come home as it were).

Of course his theory went far beyond just this simplified account, but these are the personality characteristics that set the **Boson** apart from all other particle-types that would spawn not only the entire field of **Quantum Mechanics**, but the construction of a 10 billion-dollar particle accelerator (plus dozens of others that are kept absolutely concealed from the public). And why? Because particles are not supposed to just make up how they are going to act all by themselves. Only god has the power to choose what it will and will not do. Up until this time, the only thing considered to have this ability, at least here on earth, was man alone (also quietly known as god within the inner-workings of the **Jew**dicial system, because they secretly must uphold interdimensional law which emphatically states that man is the physical manifestation of god, born with **sentient birth-rites**). It proved that the particles that *make man* are themselves also *sentient*, proving that man is in fact, god.

Planck's Law that Setyendra wrote his theory based on, written by Max Planck, had sought to prove Einstein's theory of the speed of light to be a constant. Setyendra flatly dismissed this as a fantasy, because light travels at the speed by which it chooses, not by particle interference. This was the beginning of the end for the Theory of Relativity which would go on to be dismantled by Quantum Mechanics on virtually every level. Max Planck was not just the originator of Quantum Theory, but it is his quantum measurement of *time* that immortalized his name later in what would be called simply **Plancks** or **Planck Time**. Plancks are the units of measurement used as a basis for quantum computing which uses Bloch or **Qubit** spheres and geometric symbols to process data, rather than the binary system which is millions of times slower in data speed. Quantum computers do not process equations like current computers do, because their data is harvested from **more than just this material dimension** by particles that phase between this one and others (which is the basis for Quantum Mechanics). The technology is still in its infancy in mainstream of course, but secret government agencies have been using them for not just years, but for decades, even before modern computers made it to public market. The symbols they use instead of ones and zeros are the symbols of cellular memory, or the actual symbols of interstellar language. You won't be seeing them in school anytime soon.

Decoding The Hive

creation of gravity, light, time and the god particle

HIGGS BOSON

This brings us to the **Boson** that **Peter Higgs** brought to the foreground in quantum research. While researching the Higgs Boson in actual laboratory tests, for some not-so-amazing reason, the **material** that was used for search of the god particle is widely **missing** from many reports. And of course it is, because a Boson carries qualities that cannot be explained, and if you were to find out that it came from water, specifically heavy water or Deuterium, you might have too many questions for the particle community. In **December of 2013** Higgs was awarded the Nobel Prize for accurately predicting that this incredible particle would be shown to exist one day and not just in theory. However, even though the search for the god particle is now put to bed, the “graviton” issue has not and remains today as the single most enigmatic element within creation that has escaped the grasp of modern science.

Six months prior to Higg’s Nobel Prize, I published my *Theory of Spatial Relativity* that explained the god particle as well as gravity in some detail. In this report I intend to show that not only is the god particle actually crystal, after that message (and that’s what the god particle is actually carrying, a message) it also then becomes what appears to be sentient (because it has the ability to pick and choose how it will go about fulfilling its mission to carry forward the message), and it is also delivered throughout the planet by the graviton which is liquid Deuterium. You will have to be the judge of whether I do my job or not, since I doubt the scientific field will be any too excited to pick up this torch themselves. Will you be surprised when the hidden symbols for that particle lead directly back to the very ancient SUNS of Ba’al and their sycophant hand-maiden Hermes Satain?

Below is the **Atlas Project** at the **CERN Large Hadron Collider**. On the right is the 8-point star (their **crest** or **Signet**) of the bloodline of the Nibiruean royal elite (specifically the faction of Sumerians who installed the Diodic Crystal Energy Grid). This is the **Base-8 Vibrational Scalar Science** platform that their group uses for their own applications of aether-command (which is slightly different from the **Metatron Scalar Science** touched on in **The History Of The Pentagram** chapter). The **Nibiru Zephelium** work hand-in-hand with the **Pleiadean Anunnaki** (Nephilim giants) in many **Illuminati Programs** (which CERN is one of). The Titan **Atlas** was one of the mythological gods of Greece, son of **Iapetus (Japeth)** of the babble) and one of the sons of **Marduk Satain**. In other words, Atlas would be under the **Nibiru (8-point star) Scalar Vibrational Science platform**, just to put a name to the face of CERN for you:

Decoding The Hive

creation of gravity, light, time and the god particle

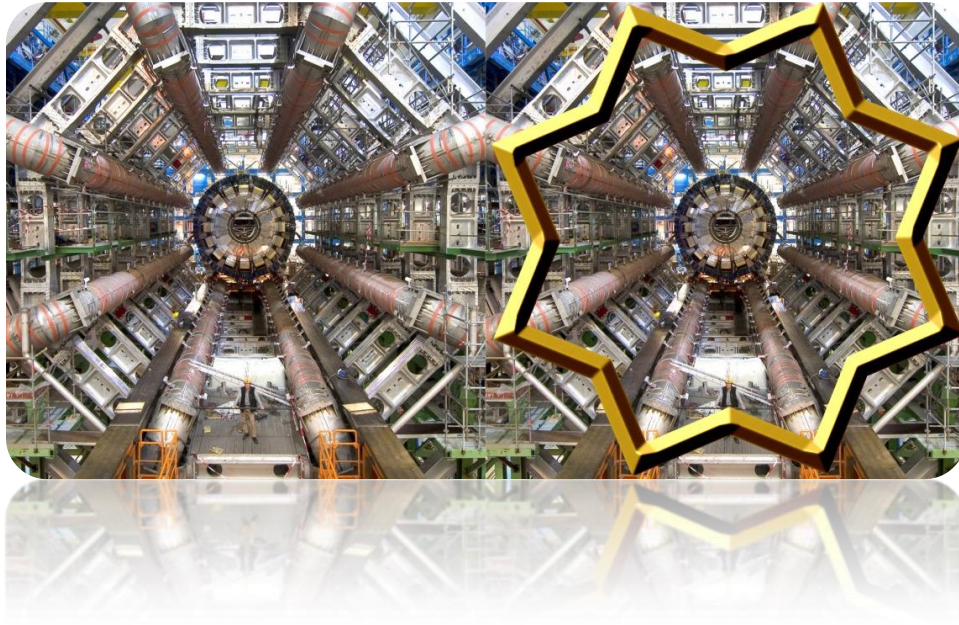

DEUTERIUM IS THERMONUCLEAR FUSION

Deuterium water is so dense in concentration of ion-energized **crystal** that it physically weighs much more than the water floating above it at the ocean floor, and this concentration of crystal is also **the energy source** of nuclear warheads and reactors. Science *is lying* when they say they are using Deuterium only *as the coolant* in nuclear reactors around the world as you will see in just a second.

Not only is the energy source behind the most powerful machine (CERN) ever conceived crystal, but literally the most powerful energy source known to mankind; Thermonuclear Fusion. A fusion reaction is achieved just like a fire is achieved. You find some material that will burn, then you apply an ignition (a spark). Of course you need to make sure you have enough oxygen for the process. Deuterium *doesn't have oxygen*, it is merely 100% fuel in the form of resting hydrogen and oxygen. Uranium **mimics the sun** to provide the *initial oxygen* (lighting the fuse) and the friction of the **bombardment** provides the *match*. When Uranium-238 is bombarded with Deuterium as explained below, that action infuses the process with the starter-oxygen which then releases **more** oxygen along with massive levels of hydrogen from the Deuterium, providing in over-abundance the three ingredients needed for the particles to complete the nuclear fuel:

Wiki: **Plutonium**;

*“**Plutonium** is a transuranic radioactive chemical element with symbol Pu and atomic number 94. It is an actinide metal of silvery-gray appearance that tarnishes when exposed to air, and forms a dull coating when oxidized. The element normally exhibits six allotropes and four oxidation states. It reacts with **carbon**, halogens, nitrogen, **silicon** and **hydrogen**. When exposed to moist air, it forms oxides and hydrides that can **expand***

Decoding The Hive

creation of gravity, light, time and the god particle

*the sample up to 70% in volume, which in turn flake off as a powder that is pyrophoric [explosive, combustible]. It is radioactive and can accumulate in **bones**, which makes the handling of plutonium dangerous.*

*Plutonium is created by **deuteron (Deuterium) bombardment** of uranium-238 in a cyclotron such as at the University of California, Berkeley.”*

Remember, exposing Deuterium to sunlight then creates **Tritium** which then adds itself to the liquid. **Tritium** is a code word for **salt**. The core of Tritium is called a **Triton**, another word for **ocean water** Ψ . They are NOT bombarding different things such as “Tritium” and “Deuterium” to the Uranium crystal, they are bombarding it with OCEAN WATER that has simply been exposed to the uranium that mimics the sun while inside a controlled environment (outside of their ability to achieve direct sunlight). This is the big secret you are not supposed to know:

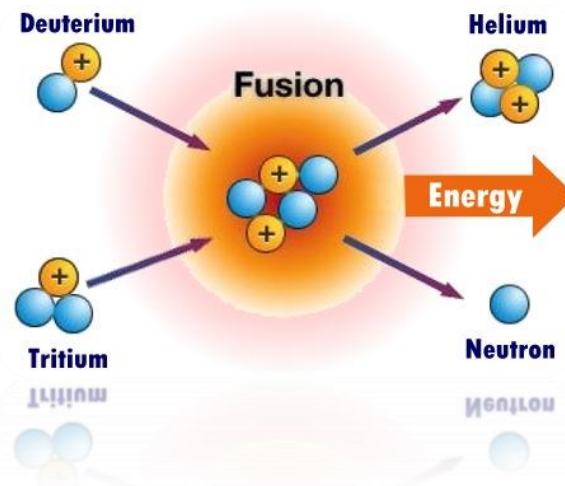

Plutonium was named after **Pluto**, the god of the underworld (another name for Marduk Satain), by the scientist that “discovered” it. Make **no mistake**, this man named **Glenn T. Seaborg** did not discover this, nor did his team members. Such technology is given to human puppets in return for their signature at the bottom of blood-oath contracts as **Initiates of The Craft**. Not only was Glenn Seaborg a **Freemason**, but he would be from the direct blood-lineage of **Enki Satain**, Marduk’s **father** which is observed in his family name, **Seaborg** (as in the **Bourjha** of the sea). Where Deuterium is **found** was named after **Enki** who is known as **EA**, the **TRITON** Ψ god of the oc**EA**n and the s**EA**. The title SE**A**borg is **S** for SAL(T), **E** for ELOHIM and **A** for ANunnaki. He would not just be a Mason (**Meson**), he would be of **ultra-royal ancestry**. Here **SE**A**borg** is sitting next to President Nixon at **Bohemian Grove** in 1957 for **blood-ritual sacrifice** to **EA** and **Ba’al** on the upper lower right. Take a bow Glenny:

Decoding The Hive

creation of gravity, light, time and the god particle



TYPES OF HYDROGEN

Hydrogen is fuel. I don't mean "a" fuel, I mean hydrogen is the thing *called* fuel, regardless of where you find it and in what form from gasoline to firewood. Hydrogen in liquid form is the most concentrated, lightest and purest form of fuel, that's why it was used on the space shuttle. This molecule known as **H** (as in the hidden h of the goddess Wawwu) makes up 75% of all baryonic *mass* known. Baryonic simply means "anything made up of protons and neutrons (electromagnetic energy)", which simply means what science calls matter. This means that 75% of all things will burn given the right level of heat. The logs on your fire and the gas in your engine have different levels of hydrogen content to put it even more simply. Some things are extremely high in hydrogen content, while others with lower levels require higher temperatures in order to burn.

It is my contention that the other 25% of all "matter" that will NOT burn are crystals, because crystal is the capsule that energy is delivered in. You are not told about this other 25% because this is the secret to free, unlimited energy. It is the crystal above that is separated in nuclear reactions that causes the enormous amount of energy release, because they are literally destroying a god in the process. Not destroying as in forever, only taking it out of its quantum physical form from the Time Matrix.

Decoding The Hive

creation of gravity, light, time and the god particle

Below is a diagram of an **Ionic Conductor** known as a pure-energy **solid oxide fuel cell**. Note that the fuel is H_2 , meaning it is hydrogen. Hydrogen comes from Deuterium. It is one-half of the quantum of the liquid silicate known of as water. The other half is oxygen:

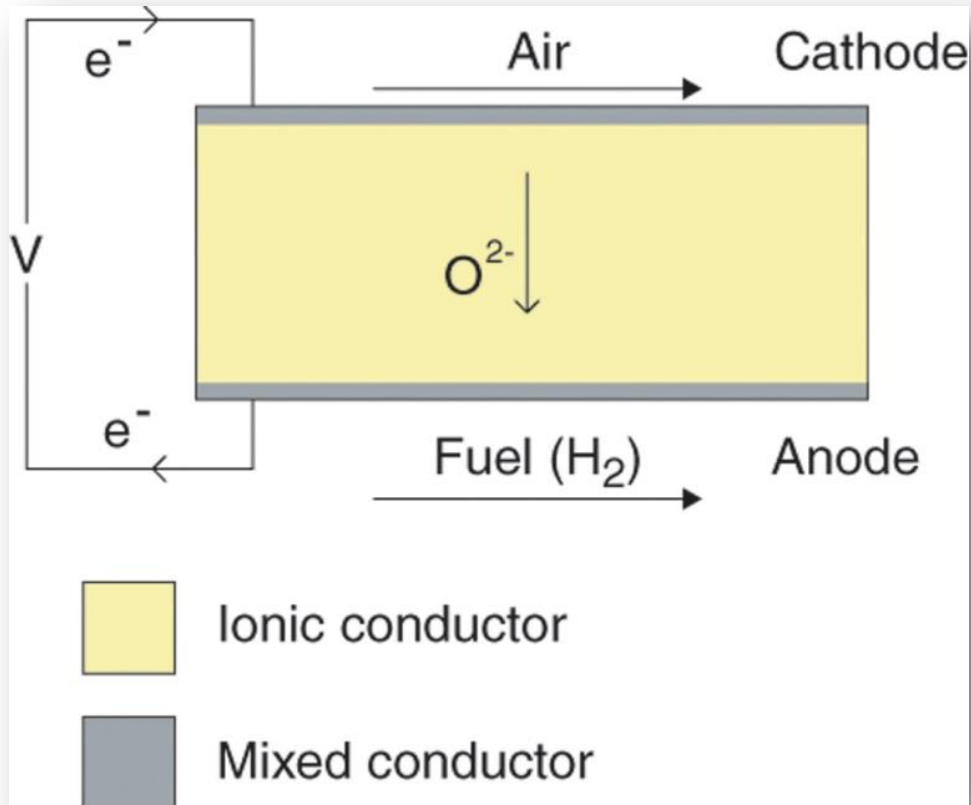

The shell separating the fuel cell above is made out of ceramic. Ceramic which is not the fuel, but merely the duct through which the fuel is delivered. This is made with non-conducting crystal.

MASS IS 3RD DIMENSIONAL LIGHT

When science goes about measuring the size of **the mass** of anything, down at the core of the molecule, what it finds is light, not mass. The only way they have of measuring that atomic “mass” is through its **photoelectronic energy signature**, because it does not physically “weigh” anything at that level. Nothing weighs anything at that level. It sometimes responds to gravitational push in the way it functions (because it is supposed to represent matter), but there is no way to measure it by this distinction. That means the only thing that is given the designation of **baryonic matter** (as in an **atom**) are those things that contain **electromagnetic energy**. All other things that do not carry an electromagnetic energy signature are labeled as subatomic particles that make up the nucleus of that molecule. They are not considered atomic, they are

Decoding The Hive

creation of gravity, light, time and the god particle

considered the powers that make atoms electromagnetic. They also have photoelectronic energy signatures, but they are different from atoms.

Below the thousands of names used for various types of crystal is carbon-silica that **does not burn**. After a fire goes out, there are always ashes left over. Ashes make what is known of as **ceramic** that do **not transfer heat** and are used as **non-conductors** of both electricity as well as heat. To isolate the nose cone of the space shuttle from the heat generated by the friction of the craft passing through flakes of pure crystal at the **Atmospheric Membrane** known as the **heart of the ionosphere** 73.1 miles above earth (explained in more detail later), the cone is made out of **ceramic** to insulate the 2700 degree heat generated by the friction at reentry. This is the same thing left over from **volcanic lava** after all things that can sustain fire have burned off, leaving nothing but 100% pure crystal called ash or volcanic rock.

There are numerous types of hydrogen, but there are two main types that are most often dealt with (because the others have half-lives of fractions of seconds or are totally unstable for instance); one is protium known as ^1H that has **one proton** and **no neutrons**. This is the hydrogen that is active and is known most commonly as **hydrogen/oxygen**.

The other type of hydrogen is in *technical terms* ^2H , but goes under the common term **D** as in **Deuterium**. I want to point out right now that of all the isotopes (basic elements) of chemical substances, hydrogen alone is the only one where science breaks the isotopes down into completely different names than each other, even though they are all strictly-speaking, hydrogen, and strictly-speaking, **fuel**. And little wonder, since it is the secret of all usable energy:

Wiki: Isotopes of Hydrogen;

“Hydrogen is the only element whose isotopes have different names that are in common use today.”

The reason for this elaborate re-naming of such isotopes is to disconnect the trail leading back to the secret. If you call the thing that burns and rises into the air (defying the laws of gravity) one thing, then you call the thing sitting at the bottom of the ocean a completely different thing, how are you ever supposed to figure out that they are both the very same things only in different levels of concentration? There are both technical terms and common terms to many thousands (millions) of things in the world today, just like there are legal terms used in the **Jewdicial** system (mentioned in this report many times) that mean the opposite of common terms. The fact that the great unwashed masses are referred to as “common” is not by accident. You get to know only what it is the elite want you to know which are never placed into common terminology, but hidden behind words from ancient Rome, Greece and Sumer-Ur.

^2H is actually **Deuterium** that science admits is made up of two types of **liquid hydrogen** that possess a **neutron** (neutrino), whereas **gas hydrogen** is missing this component. The **neutron** is a **magnetic ion** (closed, or drawing in energy -), whereas **protons** are **positive ions** (open or sending out energy +). Gas hydrogen doesn't have the neutron, because it has already been activated into fully functional energy (above ground). Liquid hydrogen that carries the neutron is locked in a state of dormancy because of this **gate keeper** particle that continually travels around

Decoding The Hive

creation of gravity, light, time and the god particle

the nucleus of the molecule keeping the energy inside just like a battery that is resting on your counter-top waiting for you to connect the two ends to something like inside your flashlight so it can begin to emit light and heat.

Active hydrogen energy floats UP all by itself. Inactive hydrogen energy is extremely heavy, heavier than water, so it is always pushing down (as in gravitational push). The functional difference between active (gas) hydrogen and inactive (liquid) hydrogen is the concentration of energy inside the particle and the fact that the latter is still in liquid form. That means that the only weight that Deuterium possesses that is **opposite** of active hydrogen is **energy**, along with the little battery-covers that hold the energy inside (carbon crystals) and the liquid that is its transport vehicle. The liquid surrounding them evaporate off as soon as it is exposed to sunlight, so the only thing that is actually different between the two is energy itself. Spent hydrogen is *void of ions*. Active hydrogen is *full of ions*. Dormant hydrogen is both full of *ions* and *incredibly heavy*. In other words energy does translate into weight when combined with trillions of other particles. Energy is heavy, not particles.

HYDROGEN: CODE FOR ION ENERGY

Spent crystal has no measurable weight within this dimension, and therefore cannot be measured unless it is carrying something (hence the 25% baryonic matter), such as ion energy (which makes up the remaining 75%). Pure carbon crystal defies the laws of physics because it is the multi-dimensional base-material that provides the energy delivery-system to power gravity called amneo fluid, commonly known as water. The **ONLY** thing that can bring spent hydrogen (raw crystal) back down to earth is WATER (gravity). This is visibly shown to you every time it snows. All you have to do is look at the snowflake itself to see that frozen water particles are holding the crystals together in order to escort it back down to the core of earth again so it can be used as the battery-shell to carry more ion energy back up to power the planet's life-field. (Raindrops hold the same crystals together as a glue as well, but it reverts back to its *geometric* form once reduced to freezing.) And that process always takes the shape of the core-DNA imprint of the 6-point Hexagram pattern, because that is the original **Keylon Grid Template** of its mission:

Decoding The Hive

creation of gravity, light, time and the god particle

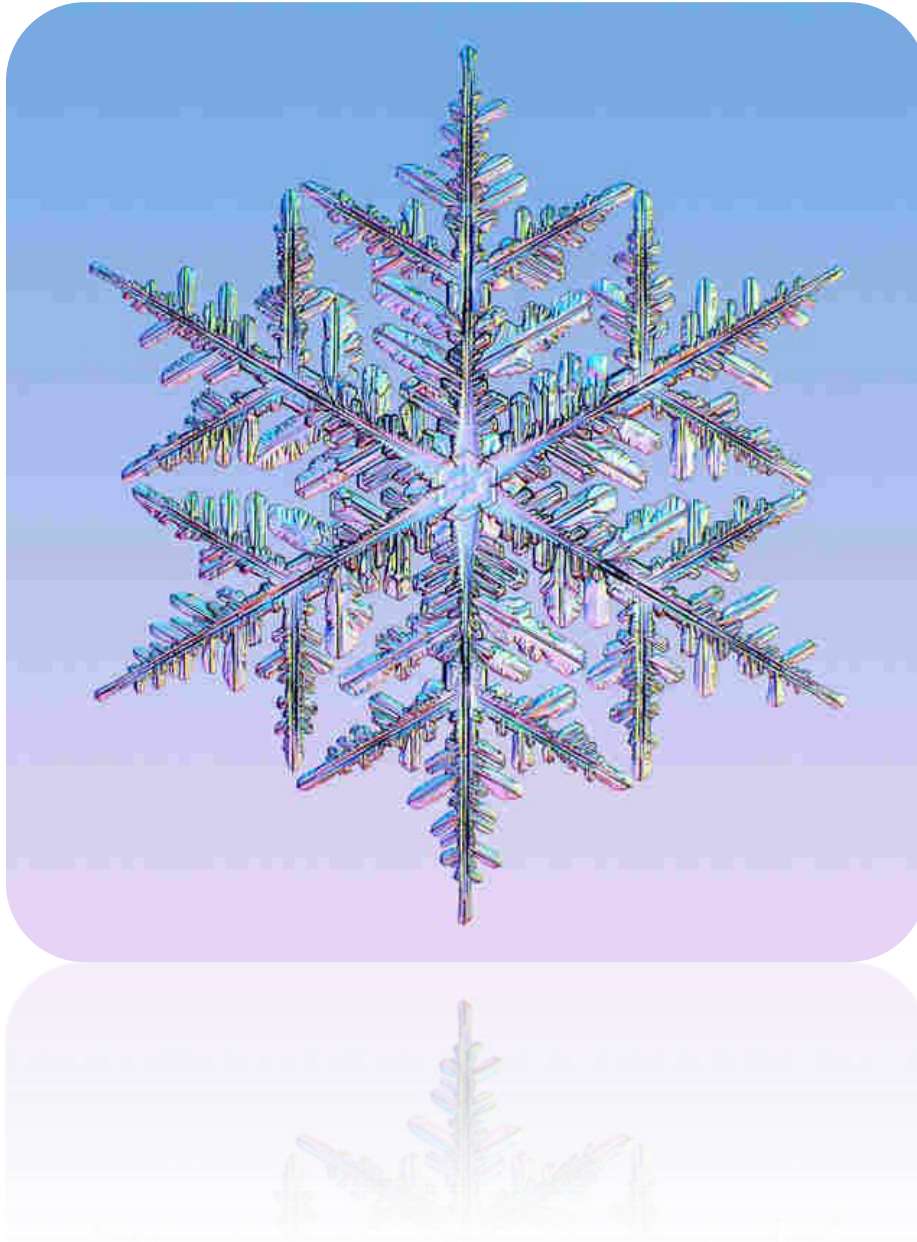

This means that the only crystals that physically weigh anything, such as the one in your necklace, are absolutely full of ionic energy (enough to level the entire city or county you live in if released suddenly). This is why crystals were described to me as “*infinitely powerful*”.

If you are wondering about my choice of words or materials to explain how the superconductor of crystal works inside a SOFC Ion Conductor:

Sciencedirect dot com:

*“In oxygen ion conductors, current flow occurs by the movement of oxide ions through the **crystal lattice**. This movement is a result of thermally-activated hopping of the **oxygen**”*

Decoding The Hive

creation of gravity, light, time and the god particle

ions, moving from crystal lattice site to crystal lattice site, with a superimposed drift in the direction of the electric field.”

Crystals are the fabric of energy. Oxygen is their power, the breath of life.

URANIUM PURE OXYGEN IONIC CONDUCTOR

The H in “H BOMB” stands for Hydrogen, of which Deuterium’s core is entirely made up, just in its *dormant* state. Uranium crystal is really another word for super-concentrated solid oxygen known as **SOFC**, or *solid oxide fuel cell*. Even the name itself is misleading of course, because oxygen is not fuel, and oxygen doesn’t burn. All oxygen does is provide the catalyst for **fuel** to burn. Uranium does not power the hydrogen bomb, it merely provides the match, as uranium is a fissionable material. Which means that the particles inside uranium go ballistic when they come into contact with fuel, which is hydrogen. The way uranium does this is through the structured lattice of 8 oxygen particles surrounding each uranium particle that provides the crystal barrier between heat transference of the hydrogen mixing with the oxygen on a wholesale level. It is not necessary for you to understand how to actually duplicate this reaction in order to understand that a *hydrogen bomb* is not called a *uranium bomb* for a reason.

Those 8 oxygen particles are following the mathematic sequence of the Base 8 Metatron Scalar Science we have covered. They are the 8 corners of a hyper CUBE. Keep this in mind. This is the **eightfold way** of quantum science.

The delivery shell created by uranium-238 remains stable even when oxygen (air) is applied to its **outer shell** up to high temperatures of 800 degrees (such as experienced in delivery of a bomb traveling at 11,000 MPH or 7 times faster than a speeding bullet). The easiest way to think of uranium on a simplified basis is to think of that form of crystal as super-concentrated solid oxygen. And the easiest way to think of Deuterium is super-concentrated liquid fuel which is **both hydrogen and oxygen**. The blending of the two together at the right feed-rates creates a chemical reaction (assisted friction) that ignites the fuel, creating fission balls that bounce around like millions of tennis balls dipped in kerosene that light everything on fire around them. Under controlled blending, those fission balls are able to produce controllable heat that warms up regular water which creates steam which turns the blades of a turbine, which then creates electricity.

And it really is just that simple. Put water and rocks together to get nuclear energy that produces nuclear waste that has a half-life of deadly radiation that kills everything around it for 1/4 million years, just so you can turn a wheel around that draws the energy out of magnets so you can make electricity. When you could just simply put paddles in the ocean tide that move the paddles back and forth to create the exact same energy with zero risk. Only someone who hates humans would ever even think up something that intensely sociopathic and intellectually bankrupt.

The nuclear industry sates that water is simply used to cool nuclear reactors that are producing energy. And this is partially true, but water is used all throughout the process, from causing the

Decoding The Hive

creation of gravity, light, time and the god particle

energetic reaction, to harnessing the energy to turn the turbines, to regulating the temperature so the whole thing doesn't turn into Chernobyl. Deuterium heavy water is needed however to even begin the process, but regular water is certainly also needed to control the Deuterium when it begins to release nuclear energy and therefore heat. When Fukushima's 4 nuclear reactors were hit by a tsunami created by multiple ocean-floor tactical nukes (guess why they are located on the ocean floor), the flooding of the system put too much Deuterium in direct contact with the fuel rods creating multiple open-air fission explosions (which then feed on all the hydrogen inside of everything surrounding it) that are impossible to extinguish (at least with human-level knowledge). These reactors have been burning out of control for 6 years already, and there is no such thing as an estimated date of having them under control. No amount of water-cooling is able to manage such extreme temperatures, that's why all of this drama unfolded initially entirely underwater, and are entirely underwater even now, burning like a house on fire (or more like 20 million houses on fire). Flame produced by pure hydrogen is so hot that it isn't even visible and in extreme amounts has the power to vaporize effectively anything in its path with likely the only exception to this being pure crystal alone:

Ucsusa dot org:

*“Nuclear power plants are usually built next to lakes, rivers, and oceans. **All of the 104 nuclear reactors currently licensed to operate in the United States are light2 water reactors.** Sixty-nine (69) are pressurized water reactors (PWRs) and 35 are boiling water reactors (BWRs).”*

Most nuclear reactors are built right on the edge of the ocean and use a “straw” leading down to the ocean floor to collect their Deuterium (100% free). Those that are built inland are always positioned over the top of one of earth's Planetary Hydroducts (that channels heavy water Deuterium out to each of the Krystal Cathedral Energy Grids (capacitors)), then pumps pure D liquid hydrogen into a reaction chamber that bombards uranium or plutonium crystals that releases their concentrated oxygen core. Some of the ocean-side plants are also built right on top of the underwater Deuterium rivers, such as Fukushima, which means when such plants melt down, the fission reaction burns through the foundation, through the mantle separating the building from the Deuterium, then drops down into the Hydroduct itself. Such event is not just catastrophic when the fire is fueled by pure concentrated energy and also bathing in oxygen-infused higher-level ocean water, but in very real-world terms creates the worst-*possible*-case-scenario itself.

The planetary **Pyramid Energy Grid** is also positioned over the top of such Deuterium Hydroducts (underground heavy-water rivers) as well, but the difference between how they produce energy and how nuclear power plants produce energy is the same difference between a Magrav supersonic subterranean rocket train and a wood-burning iron horse. The pyramids use the ions from the Deuterium passed through super-conductor granite, concentrate the power directly up through the spiral to the cap-stone which then broadcasts it across the land in absolutely pure D.C. form. There is zero energy loss, zero pollution, zero carbon release and zero danger. The energy that nuclear power plants produce is A.C. energy (alternating current) which is obviously deadly and in more ways than just being electrocuted, but the waves produced by the energy envelope the area around them which gives people cancer. These are micro (small)

Decoding The Hive

creation of gravity, light, time and the god particle

waves of a frequency that is slowly deadly to animated life. Just having this energy totally surrounding your house in the wires hidden in the walls or being broadcast out deliberately in WiFi signals is the same thing as having a few microwave ovens running continuously with their doors standing open.

The SHAPE of the **Plutonium Allotrope** is strictly telling, as the process used to release the energy from the Deuterium just so happens to be, geometrically speaking, a pyramid. The KEYLON Grid base to material manifestation is two pyramids, one pointing up, the other pointing down. The product of nuclear fusion separates those two pyramids from each other, hence *splitting the hydrogen* creating a **nucleus** or “nuclear” release of super-concentrated fuel:

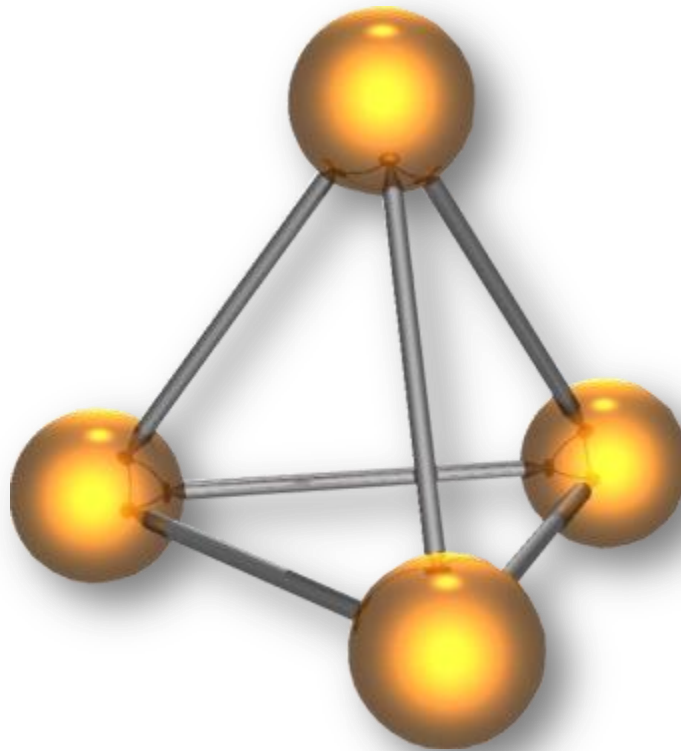

Plutonium-238 which is needed for nuclear reaction **can not be** produced without Deuterium:

Wiki: ***Plutonium-238***;

*“Producing plutonium-238 is achieved by **bombarding** uranium-238 with **deuterium** (hydrogen-2), which produces **neptunium-238** and 2 neutrons. **The unstable neptunium then decays to form plutonium-238.**”*

Neptunium, as just covered previously, is **Plutonium**, and you can’t find any **Deuterium** to make **Neptunium** outside of the *sea or ocean*. If you think that the name **Neptune** is an accident in this equation, you are not following along. Later you will learn how it is that the most

Decoding The Hive

creation of gravity, light, time and the god particle

powerful of all particles is not only found in water but it is made up of **Leptons**, which is another word for **Neptune Ψ** just like **Triton**. The power at the bottom of the ocean is enough to blow this planet into spacedust a *billion times* over. All that is missing from natural mixing of elements by nature from super-concentrated hydrogen is the **oxidizer (stable oxygen)** which is released by the waves of the sun. Oxygen is also stored in earth in *pre-packaged, ready-to-go* form in uranium. That is why pure oxygen uranium crystals are not stored in the same place Deuterium is stored. Plutonium is *not* able to create *insane ridiculous energy*, it is able to create enough oxygen to light a hot enough match to trigger the full release of Deuterium energy all at once.

As you can see by the image below, oxygen which is produced by the sun through photosynthesis (interacting with the elements in water) is separated from the lower portions of the ocean where Deuterium is stored. Oxygen is eternally pushing upward while in water, seeking the furthest possible location **away** from Deuterium at all times to avoid a nuclear reaction that could take out the entire Time Matrix:

worldoceanreview dot com:

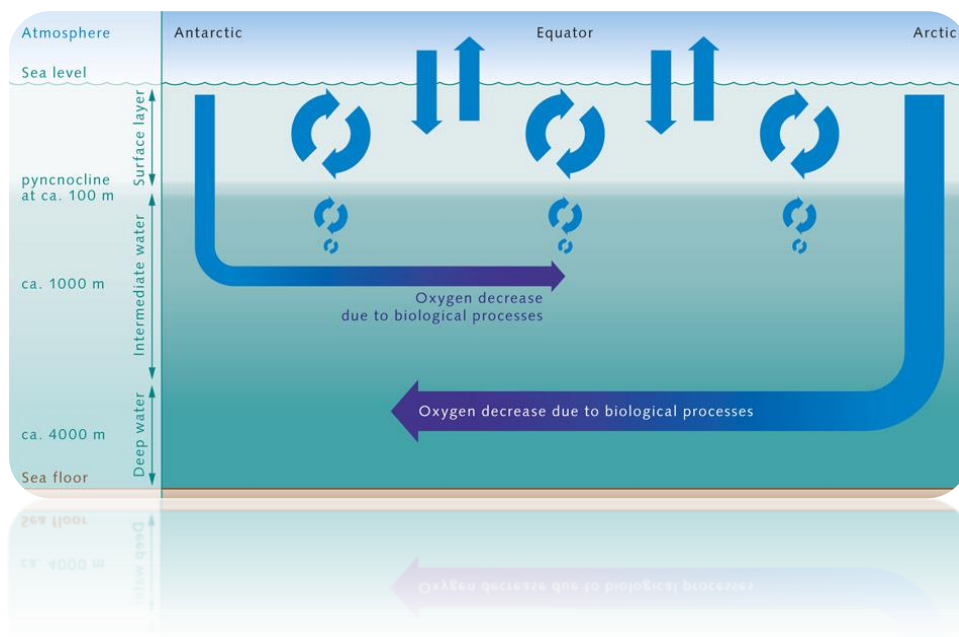

*“Photosynthetic production of oxygen is limited, however, to the uppermost, **sunlit layer of the ocean**. This only extends to a depth of around 100 metres and, because of the stable density layering of the ocean, it is largely separated from the enormous underlying volume of the deeper ocean. Moreover, most of the oxygen generated by the primary producers escapes into the atmosphere within a short time, and thus does not contribute to oxygen enrichment in the deep water column.”*

If you were curious about what **Uranium** looks like, you might enjoy this:

Decoding The Hive

creation of gravity, light, time and the god particle



You have seen for yourself that crystals are at the core of all energy, and that pure sand (cleansed of the bio-compost we call dirt) is always crystal. When that crystal is pressed together into sheets which look like an old floppy-disc then stacked together with an **oxidizer** between each sheet, then combined with guess what? *water*, they produce energy. Free, unlimited, bio-safe, eternally-renewable energy.

The photo below is what tin looks like in its natural form. The crystal composition of this natural resource on earth, believe it or not, happens to be one of the most coveted minerals on our planet by outside beings who come to harvest certain precious metals. We use it for old tin sheds and other crude applications, but it is so valuable that it makes diamonds and gold look like dirt in comparison when it comes to their mining operations:

Decoding The Hive

creation of gravity, light, time and the god particle



I promised to tell you what sentience, exactly, is behind crystals at the start of this section, and explained that the sentience behind the entire Silicate Matrix (in and outside of this one dimension) overall comes from the **Eternal Unified Field of god-source**. However, on a more intimate level, there is one mind that manages the aether crystals for levels 1, 2 and 3 (you are in level 3 now). You live on a carbon-crystal life-field we call earth. Modern science has reported that crystals are not entirely solid, nor are they entirely liquid, but a combination. This is like the blood cells of your body. If you dry all the liquid (water) from the blood, what is left are crystals, just like when you boil water down to the solid that is left over that I mentioned, called calcium. Calcium, or dried liquid crystal, is what makes up your bones, your fingernails and teeth to name a few parts which are left over after a biological form ceases living. They are the crystals that make up the skeleton of your body, and in the very same way, larger earth crystals are the skeleton of the earth's body. **Crystals carry earth's sentience**. So when you are talking to your crystals, know you are speaking directly to Earth (who apparently still likes to go by the name of **Tara**).

From here we move into the real meat of this report where you will learn about atoms, electrons, neutrinos, ions and even what a *god particle* is next. This will be a proper introduction to the **S@t@in CϕphΞr** where the scientific symbols used for each type of particle will really begin showing you how the cipher functions on a sub-quantum level within the context of using Keylon Template Signets (geometric signatures) to manifest reality on a scale that will be

Decoding The Hive

creation of gravity, light, time and the god particle

beyond breathtaking. Where certain Sentient beings have chosen to manifest not just one individual action (such as build me a house), but to create an entire universe (an artificial universe that was never sanctioned by the creators of this Time Matrix) by using millions of commands held inside geometric Keylon Templates that they have boiled down to simple shapes (such as Ω or Σ) which then hold the **Fire Letter Sequence** of hundreds or thousands of spells within *each one* that are then further reduced-down to the letters and numerals in your alphabet that refer to those scientific symbols in such a way that it would be the next thing to impossible for anyone to ever figure out anything was amiss at all.

But first, we will be looking at how all of those Programs and codes work in order to do what anyone looking at a casual glance would consider absolutely impossible. Here we go.

CHAPTER 20

THE SCIENCE CYPHER



The boring photo above was taken by **CERN** at the cost of *trillions of dollars* from a neutrino and ion reading in a **Bubble Chamber**. This is a very large tank, and the lines you see from this scale look like just that, lines. 99.9999% of the population will never even bother looking at such things, because this may as well be a rock thrown into a muddy pond for all we care. This is not worth our time when we have more important things to pay attention to like braces, soccer practice and what Miley and Milania are wearing today. But there must be a reason the ruling elite spend billions or trillions of your dollars every year studying such drivel. There is. And as long as you focus on the obvious, you will never see what answers lie underneath the distractions we think of as life while handing over our tacit consent for someone else to tell us what to think and where to stand.

Decoding The Hive

creation of gravity, light, time and the god particle

Make no mistake, this isn't just another trite issue being sensationalized so I will have something to jot down to fill the pages between the covers of just another book. This is the realm of the gods themselves. Everything about nuclear energy and how the aether works have their fingerprints all over it, but since nuclear physicists rarely go about speaking to the great unwashed masses, and certainly not in the context of revealing the true provenance behind the most hidden of all subjects, that's not something you are likely going to know much about.

Knowledge is power. Real knowledge is real power. Money and fame are feckless and inconsequential to those looking to enslave and administer entire planets. And the gods of old who once ran this entire planet *never retired*. They only disappeared from the dusty streets of your everyday lives, but they certainly *did not* go away. This is not conjecture. The big picture is only found in the microscopic things that combine to make the image. By reaching this far in this report, you are taking the first step toward taking back what was supposed to be yours from the start; freedom. Getting through the coming pages of this first installment on the hidden tools of enslavement of mankind will not be simple. I am going to ask you to follow me through no-man's land and into the domain of rocket science so you can see first-hand why it was that good people were so readily persuaded to throw their own babies into the fires Ba'al. The gods didn't just beat on drums and wave spears in the air, they brought down the sledgehammer of thunder and lightning itself from the sky. And they did that by using atomic nuclear power.

Now look at the picture again and this time, think of the circle as the earth and the lines as bars locking everyone inside. Where the bars come from and how they are made are the keys to the door because that's what's going on. Tiny elements are the real chains of your existence, not the bars of steel that are factually made up of 100% *light* that will continue to look like steel until you understand how steel is actually created. Just like virtually everything else in your world, steel is made entirely out of crystals that are Sentient beings that are here to do one thing; what you ask them to do. Think about that for a second.

ATOMS, IONS AND SUBATOMIC PARTICLES

There is a difference between atoms and particles in the parlance of modern science. An atom is holding the shape of something, and subatomic particles are what makes up atoms. An **atom** is actively using **both sides** of electromagnetic energy (magnetic push and pull), and **subatomic** particles do not. In previous chapters I illustrated for you what an electron is, what protons are and what quarks are within the context of what makes up molecules which are multiple types of atoms that are now all holding the shape of visible matter. We will go over this again, only this time we are going to get down to what quarks are called by their individual names. Not because there is really such a thing as different particles, but because the command that each wave is following is *acting* like different things inside of this dimension. And those attributes have been given an hierarchy within the nomenclature of particle physics. They carry different symbols that signify the difference between a lepton, muon, ion, boson, anion, cation and so forth. You won't need to know every single designation between these in order to understand how they work, but you will need to know what the action of certain elements are to see how they refer to the gods

Decoding The Hive

creation of gravity, light, time and the god particle

and how those symbols are encoded in the spells that surround you in everyday life that literally lock you into a prison the average person would simply never even imagine exists.

To my knowledge, this will be the first time this subject has ever been broken down in the context of Scalar Vibrational Science and in the Metatron-speak of the **S@t@in Cϕphɛr** (called modern science), at least within many millennia. The unthinkable depth by which subatomic particle symbols have been deeply, deeply hidden, reversed and distorted may seem insane to you right now, but if you knew how to connect the symbols to the talisman Keylon Command Templates they power, you would begin to dissect how all their Programs actually work. It is my intention to show you the very first steps of how to do that now. Like the **S@t@in Cϕphɛr** itself, this will be a new language for you to learn so this will not be easy. But once you begin to see the patterns for yourself and how it all fits together, you will enter the world of the **S@t@in Cϕphɛr** with a real understanding of why certain titles and words were constructed the way they were, and in some cases which entities are behind the different spells.

The big players in atomic-particle physics are electrons, protons and neutrons. Below that are the little particles that power the big particles. Science will refer to them in this way, then they will turn around and tell you that this tiny little part of the neutrino (or ion, etc.) actually has 3500 times as much power as an atom. Which tells you right up front that something is seriously amiss within their explanations. Getting down to the truth means starting at the beginning and working our way up from there.

MAGNETIC ENERGY

An **electron** (-) holds together the particles that look like a desk or a tree. **Inside** the atom, one or two **protons** carry the positive (+) energy of that collective. Finally one or two **neutrons** carry static or inert energy at the core of the atom. The three then completes the circuit of both sides of electric and magnetic energy. Science refers to the neutron's zero-spin as negative (-). This means that there are actually just 2 **different** elements to an atom **acting like** 3. Two of those elements (the negative electron and the positive proton) are carrying PHYSICAL, MATERIAL energy that will go on to build a desk or build a tree. The other one, the neutron, is aetheric in that it carries BOTH negative and positive energies, but is not PERSONALLY spinning. Just being within the presence of an electron gives that atom the active push and pull. Which means that a neutron is also clearly providing the **electron energy** (-) to the symphony. It is the SPIRIT of the atom. Together the proton (+) works with the spirit to **make up** what is called electromagnetic energy, which is then **3rd dimensional energy** that forms what you can see and touch here in the real world. These are the "1+1=3" I will be mentioning quite a bit about as we go.

This means in simpler terms that all energy is both negative and positive at its core (as shown clearly in the previous chapters regarding **Partika** (+) and **Particum** (-) **Partiki** cells that are just smaller versions of **Up** (+) and **Down** (-) quarks that are just smaller versions of **Positive** (+) and **Negative** (-) atoms). When these two are **activated**, then suddenly the **proton** (+) and the **electron** (-) spring to life and begin holding the shape of what we call material. It is that

Decoding The Hive

creation of gravity, light, time and the god particle

activation process I will be focusing on the most over the coming pages and what **CERN** focuses on in an ongoing basis at the **Large Hadron Collider**.

Subatomic particles carry both the positive charge, and the negative charge within their makeup, but they are not yet active, meaning they don't push **and** pull at the same time against each other within their particle or their shell orbit. They are dormant. These dormant particles will be called neutral, positive or negative by science, depending on their perspective about how things are supposed to work, but as you will see, all dormant particles carry at least *some* positive, even if they are overall negative, and *some* negative even if they are overall positive in charge. You are going to hear the terms “non-spin” and “dormant” or “stasis” a great deal in the coming chapters, because these terms indicate **multidimensional energy** as you will see for yourself. These particles do not act like magnets, attracting and repulsing other atoms, they can take up the same space as one-another, they are not affected by gravity and they blink in and out of this dimension. The only thing the **CORE** of elemental particles are missing is **activation** which causes the electron **SPIRIT** to come to life that holds atoms together with what they term as the **strong force**. Keep this in mind, because it is the action of the **electron** that makes the magic happen.

ATOMIC “MATTER”

In science-speak, **atomic** is code for **atom**. **Atom** is code for **matter**. It is electro-magnetic which means it is doing something through opposing forces. **Adam** of Adam and Eve was named after **material matter** –or vice-versa-, and **Eve** was named after **multidimensional** particle energy. Forget the rib nonsense, Eve was who brought Adam into manifestation, hence the atom is material. The “Eve” particle has been deified as a person through that name, through Lilith, Hathor and all the “virgin” Marys, both black and then later as the white mother of Jesus. She is the **Holy Ghost** of the **Trinity**, or the **spirit** that moves to bring life into the material world.

All of the parts that make up an atomic **atom** are called **Leptons**. There are many other names for these particles, but **Lepton** means **material** and **spins** in an **out-of-balance fashion** called “1/2” or “2/3” spin. **Boson** means **aetheric** and has a “zero” or “full” **spin**. Everything that has a **fractional spin** stands for **Adam**, and all particles that are inert, neutral, or what I call in **stasis** stand for **Eve**, and by default stands for the power that makes things material. **Atoms** represent **fire** (energy that materializes) and aetheric **subatomic elemental** particles represent **water** and rain. Now is a good time to write that down.

ADAM AND EVE AND ELECTRONS

The biggest player in the atomic (3-D matter) world, the electron that is 100% of the time part of **Leptons (atoms)** but is transient, in that it can also be part of subatomic particles held inside the magnetic (-) particle that is always present, but just not doing anything at the moment. This is the particle that carries the **strong force** of atomic energy. An **electron** is **electricity**, or **E**, which

Decoding The Hive

creation of gravity, light, time and the god particle

stands for **Eve** and by default **Elohim** as she came from the group now known of as the **SUNS of Ba'al** or just simply **god** to mankind.

***Special Note:** I need to clarify that while Eve may have come to this playing field originally as part of the team of the Elohim, it was through **deception and coercion** and she was never actually a willing player of what the Elohim went on to do with her genetic codes. This is why Lilith was reported to have been banished from the **Adam and Eve Program** prior to symbolically renaming her position or office Eve. Not that this will mean anything to you right now, but it will later when you finally get to meet the real Lilith and Eve who are still here and have been since the very beginning, looking after the children that came from their original, real-life wombs.*

Many different particles will be called electrons, even particles that are multidimensional (dormant). Keep in mind, that **electrons** are subatomic (multidimensional), but while they are active within an atom, they are also considered matter, which means “doing something” to science. All particles that are **active** are called **matter** in their parlance, and those that are **not** currently “doing something” are called **bosons**.

Having a pencil and paper as you go through this is NOT a bad idea at all to help you keep track of what is what, but I will be deliberately *redundantly and repeatedly repeating myself*. *Redundantly*, as we go to help you recall. (If this irritates you, good, that means you are really retaining what you are learning.) Science’s descriptions and labels contradict each other **aggressively**, so expect a challenge. If you are taking notes, always write down the + or – sign next to each element so you can see just what they are talking about, because if it is + it means **Adam** and if it is – it means **Eve (Elohim)**. When **Eve** and **Adam** get together to make babies that is **EA (Enki)** the god you will come across often from history. I hope to bring you clarity between these terms so you can see through the illusion that there are really such things as different particles. All that really exist are waves that are either bringing energy TO this dimension FROM the Deity Planes, or waves that are now holding the shape of something (flashing on and off) as part of the hologram within the visual playing field. They are both aether, but once they act like something, that’s when they are called matter by science:

Wiki: ***Electron*** [-];

*“The **electron** is a subatomic particle. It is believed to be an elementary particle because it cannot be broken down into anything smaller. It is negatively charged, and may move almost at the speed of light. Electrons take part in **gravitational**, electromagnetic and weak interactions”*

Notice the highlighted word in the last sentence. Science claims that the earth itself generates the gravitational force of the planet due to its mass. Yet science also states unequivocally there is no such thing as mass, as all things are light particles (photons). And in the fine-print they are telling you right here that electrons have something to do with gravity. They also have gone to extreme lengths renaming magnetic energy as negative, when they know perfectly well that the opposite end of an electro**MAGNETIC** source from the “electro” energy which is **OUTFLOWING**, is *magnetic*, just like the name says. That’s because they want you to believe

Decoding The Hive

creation of gravity, light, time and the god particle

that the ELECTRON flowing within the atomic particles is NEGATIVE in energetic source or ZERO when it comes to energy. But it is certainly *not* zero, it is *just as powerful* as the PROTON is and under the actual definition of Electron, they indicate that it affects GRAVITY:

Wiki: Electron [-];

*“...Electrons have the smallest electrical charge. This electrical charge equals the charge of a proton, but has the opposite sign [-]. For this reason, **electrons are attracted by the protons** of atomic nuclei and usually form atoms.”*

Now let's go to the ATOM, considered the basic building block of all things. Meaning the particles that now are **activated energy cells**, ready to do something:

Wiki: Atom;

*“Every atom is composed of a nucleus and one or more electrons bound to the nucleus. The nucleus is made of one or more protons and typically a similar number of neutrons. Protons and neutrons are called nucleons. More than 99.94% of an atom's mass [energy] is in the nucleus. The protons have a positive electric charge, the **electrons have a negative electric charge**, and the neutrons have no electric charge [this is physically impossible, otherwise it could not be measured and would not exist, it is a **neutrino-ion**, or static, **dormant** energy]. If the number of protons and electrons are equal, that atom is electrically neutral. If an atom has more or fewer electrons than protons, then it has an overall negative or positive charge, respectively, **and it is called an ion.**”*

This says that if the atom is balanced-out by equal numbers of both protons and electrons, then they are **static** (or neutral). Meaning they are not yet activated by the imbalance of either type of particle which will then mark them as either POSITIVE + or MAGNETIC - . STATIC atoms are *not* atoms, they are **IONS** which they also call **bosons** which are **gravitons**. This tells you right up front that gravitons do exist, science knows about it, and yet they continue the fantasy that the earth itself simply “has” gravity due to its “mass”. By the end of this topic, you will embrace no such illusion and you will know for certain how gravity actually is created. It will never be connected to “mass”, because mass does not actually exist because this is a hologram. If mass really did exist and photons actually created mass, then your TV would weigh more while watching the news than it would while it was only showing static. And that TV would attract other TVs next to it only showing static like it were now a **magnet**.

TURNING INTO AN ATOM: ANTIGRAVITY

This is the atom broken down into a mechanical, real-world explanation:

Decoding The Hive

creation of gravity, light, time and the god particle

ATOMS - HADRONS - HALF-SPIN - EIGHTFOLD WAY

The "Eighfold Way" which explains hadrons, quarks and atoms prints out a pattern that looks like this: 

ATOM (3RD DIMENSIONAL)

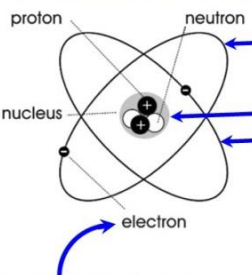

An electron (- charge) is a LEPTON, and also a FERMION. An "elementary" particle, that has no "other components" according to science with "1/1836th the mass" of a proton. Unlike a SCALAR BOSON (Higgs Boson), the electron cannot occupy the same space as another particle because it is now ready for use within "3rd Dimension". It has a "half-spin" which means it is now "active", whereas the Scalar Boson is "static" and is not "bound" like the gyroscope energy. Static energy (ions) deliver the "3D" energy to the neutrons and protons through neutrinos and crystals (ions).

GYROSCOPE

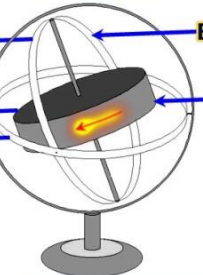

All atomic activity creates geometric patterns, not particles. This is aether.

ACTUAL ATOM

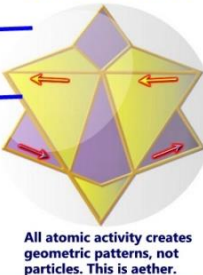

A) Nucleus of atom is momentum or "energy". Center of the gyroscope rotor axis "binds" the energy to the center-point of that force. The axis is the "zero point" where there is no force pushing or pulling, suspending the energy in zero gravity. In the core of the Actual Atom (Hierophant), the top half is "atomic" or "3D" power. The bottom half is "antiparticle" or multi-dimensional, bringing in energy from Dark Matter.

1/2 SPIN MODEL

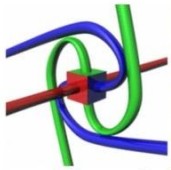

Quantum science explains how 3rd Dimensional particles are able to manage a 720 degree refresh-rate while not getting "tangled" because they insist on using "string theory" to explain how "particles" connect to each other. This is an attempt to explain away the fact that there is no such thing as a particle. When the Large Hadron Collider smashes two protons together (+ electric energy), what results are two photons. Light. There are no "particles" inside of anything. Sound waves create light waves, then light waves carry that sound, which is a message to all other waves what their next mission is. No particles or strings are involved.

B) Framework of the atom (electron) allows the "rotor" energy to tilt in any direction. As long as the momentum (energy) continues to spin, the atom and the gyroscope maintain constant balance. The electron's trajectory or "event horizon" forms a framework around energy "rotor", keeping the "nucleus" fully suspended in equilibrium just like the gyroscope.

DECODINGTHEHIVE.INFO

Atoms carry neutrons and protons that "bounce around" in counter-rotation to each other, and while the above example does show how the atom remains pointing north if it has a positive spin, the simple gyroscope doesn't actually show how the atom is also able to totally counter gravity, allowing it to elevate higher or lower while doing its job. The below explanation of how a gyroscope would be able to **mechanically emulate** that action is the same method used by the mechanical anti-gravity time crafts that phase in and out of visibility and isolate the craft from all gravitational push. Such crafts are typically built for use within this atmosphere, so I am not showing you the technology needed to navigate zero 3rd dimensional particle-content above the troposphere, but up to thin air level, this is how it's achieved through magnets. It has already been established that atoms are electromagnetic, meaning they use the push and pull of magnets in order to function. So do time crafts (or at least these 3rd dimensional hover crafts called flying saucers):

Decoding The Hive

creation of gravity, light, time and the god particle

MAGRAV ZERO-POINT ANTI GRAVITY

GYROSCOPE ANTI-GRAVITY

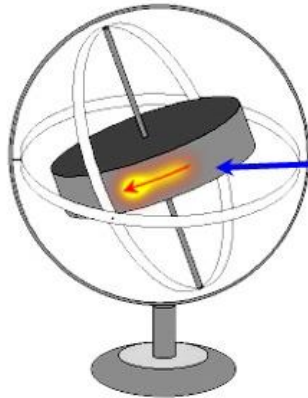

MAGNETIC ANTI-GRAVITY

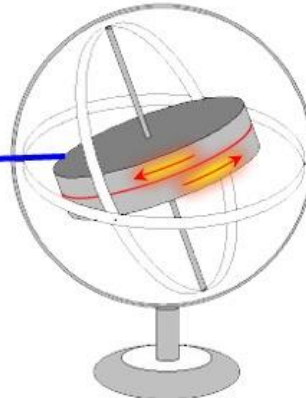

A gyroscope utilizes a single flywheel to generate counterbalance. The inertia of the "steel" then is self-balancing (producing zero gravity). Positive-directional magnets fitted under one rotor, and magnetic-directional magnets on top of another rotor below cause the rotors to travel in opposite direction. This is free, perpetual motion. Each rotor cancels out the other, but the inertia is still the same. The bearings each rotor spins on are magnetic, so no steel ever touches steel. In reality, no steel is moving, only photons "travel" which causes the torus-field around the "frame" of the gyroscope, suspending it in "space".

DECODINGTHEHIVE.INFO

This explains how the atom or hover craft is able to remain in equilibrium and also to travel up and down, depending on how fast the counter-rotation is allowed to spin, but it doesn't explain how the atom is able to navigate backward and forward or side to side. The counter-rotating double-rotors shown in the Magnetic Anti-Gravity image create perpetual inertia and the force of the zero-point repulsion zone which creates the torus-field around the craft. Likewise the **awareness of the aether** inside the atom can be **emulated** mechanically by using those forces in a triangulation of the center zero-point of the main body of the craft by mounting them to one side of that zero-point and 90 degrees to either side. This gives the operator the ability to decide to go left, right, forward or backward:

Decoding The Hive

creation of gravity, light, time and the god particle

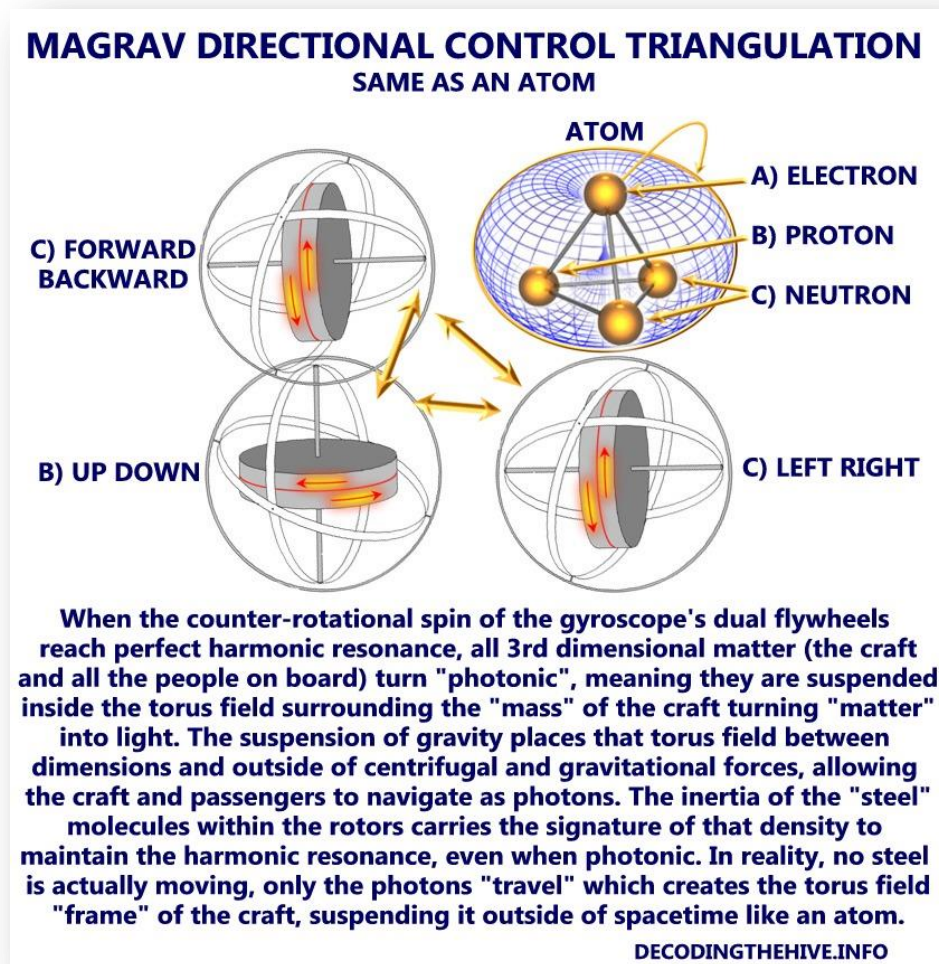

This hopefully gives you an understanding about how the triangulation of the positive and negative (magnetic) energies inside the atom work at least within the context of their movement, not in the context of forming molecules that will form your desk or a tree. All I am doing is showing you how a physical wave is able to move around with scalar-vector accuracy. In reality, all the atom actually does is *escort crystals* up into the atmosphere that will blink on and off once their precise location has been identified by the **Higgs Boson** which we will speak much about as we go.

CRYSTALS ARE AETHER PARTICLES

Atoms power crystals to blink certain colors. That's it. They don't actually "create desks and trees", but how science has explained how atoms are supposed to be functioning; it's as if the atom is physically creating material things. They aren't. Once the frequency of the light created by a crystal hits a certain harmonic note within their **mission pixel** (quadrant vector), that note either carries with it the **density and gravitational value** of a "rock" or the density and

Decoding The Hive

creation of gravity, light, time and the god particle

gravitational value of a leaf or other “thing”. That LIGHT they produce will carry the audible SOUND that tells the next aether particle (crystal) the CODE of a rock or a leaf and then the aether crystal will assign GRAVITY (density) to that thing which will determine how hard or soft it might *feel* to you, or how *heavy* it is. The codes carried in the wave determine the color that the atom is going to produce in the form of a flash or **spark** that is going to determine how it will manifest as if it were actual *matter*. **ONLY a Sentient being can produce a spark**. That means that every crystal that will be producing that spark is SENTIENT. Crystals are the physical presence of Sentient fractals of god source who function within a Time Matrix as aether particles, just as your Sentient physical presence is in the form of a human body.

IONS AND NEUTRINOS

Ions are resting energy. Really, really powerful energy. While the ion is in **stasis**, science calls it a neutral atom (**boson**), but once it has brushed past an activating particle (a neutrino), then it is called an ion that now carries a signature of either positive or negative. However, as you will see, ions while in resting state print out a pattern in the water (where ions are found in greatest abundance, because water is **liquid crystal**), so even though they are in stasis and do not spin, they are in fact also moving which breaks the laws of physics (hence why they are considered bosons). So, they call the ion by multiple different names and claim it is merely a neutral atom until it becomes more than that. It is confusing to say the least, but once you learn just what an ion really is, this will all become very clear. It is being hidden on purpose what this element actually is:

*Wiki: **Ion**;*

*“An ion (/ˈaɪən, -vɪn/) is **an atom**, or a molecule, in which the total number of electrons is not equal to the total number of protons, giving the atom or molecule a net positive or negative electrical charge. An atom, or molecule, with a net positive charge is a **cation**. An atom, or molecule, with a net negative charge is an **anion**. Because of their opposite electric charges, cations and anions attract each other **and readily form ionic compounds**, such as salts.*

***Ions can be created by chemical means, such as the dissolution of a salt into water, or by physical means, such as passing a direct current through a conducting solution, which will dissolve the anode via ionization.**”*

Science calls resting ions photons because they are acting like a photon which is visible but doesn't “do” anything on a material level. Light waves don't knock down buildings, but they are obviously HERE. Once a WATER photon has been activated by a neutrino, it becomes an ion atom. That atom has a zero spin and carries the codes to create oxygen and hydrogen, which is **energy** and **oxidizer** which makes it rocket fuel, as it can sustain a burn or create fire anywhere, underwater or out in space. When positive ions and magnetic ions interact and “mate” that creates SALT or *electromagnetic energy (EE)*. As we cover this more deeply, you will see that

Decoding The Hive

creation of gravity, light, time and the god particle

water photons (which ARE ions, just not yet called that by science) are the most powerful photons within the 3rd dimension, and what is so special about the salt they shed.

Remember, salt is crystal, crystals are sentient. Putting salt into tap water makes it an energy conductor, meaning you are now filling that water up with electricity that is merely waiting to be used in one way or the other. Baghdad Batteries gave Sumerians (pre-Egyptian times) electricity thousands of years ago, just by slipping two different types of metal into the water they added salt to. More later.

MULTIDIMENSIONAL NEUTRINOS

A Neutrino is a complex fundamental particle that has yet to be officially (passed along to you) defined by science. It is made up of three elements and because this is such a vitally important subject, I am going to paste in a few lines from Wikipedia, then I will go over **definitions** of their explanation so you can better understand what a totally bizarre particle this is. I will mark inside the quoted text with **[brackets]** in numbered form to make it easy for you to reference the context that my comments refer directly to. The **blue** section below will be covered in the next chapter and you will see why when we get there. The unique signature of this form of energy you will never have heard of until now unless you are a particle physicist. Please pay special attention to any **emboldened** sections, as these are clues to what you are really looking at. While you are reading, imagine to yourself how *god* is defined by religion and how *aether* is defined by mystics:

Wiki: Neutrinos;

*Neutrinos are a type of elementary particle that exist **all across the universe** [1]. Physicists study these particles, but they are hard to find because they have a very small chance of interacting with regular matter. (For example, they **pass through the whole earth without touching any other particles**) [2].*

*We used to think that they have **no mass** [3], but a few years ago physicists found that they have a very small mass, **much lighter than electrons** [4].*

*Neutrinos are very difficult to detect. They are very unlikely to collide (interact, in this case) with other particles as they travel through space or through matter. **Unlike negatively charged electrons, neutrinos have no charge (neutrino meaning small neutral particle). This means that they are unaffected by the electromagnetic force, too** [5]. Detectors built to find them only see 10-15 a year.*

*They are commonly generated in particle accelerators, **the sun** [6], nuclear reactions, and other stars. They are generated whenever there is a nuclear reaction in the form of Beta decay. **This process starts off with one neutron, and ends with one electron, one proton, and one neutrino** [7].*

Decoding The Hive

creation of gravity, light, time and the god particle

The 3 types of neutrinos are named after the previous three leptons. There is the electron neutrino (ν_e), the muon neutrino (ν_μ), and the tau neutrino (ν_τ) [8].

Each neutrino has an antiparticle, called an antineutrino. Therefore, there is an electron antineutrino, a muon antineutrino, and tau antineutrino [9].

The three types of neutrinos change into each other over time, so an electron neutrino could turn into a tau neutrino and then back again [10]. This is called neutrino oscillation.

Most neutrinos passing through the Earth come from the Sun. About 65 billion (6.5×10^{10}) solar neutrinos per second pass through every square centimeter perpendicular to the direction of the Sun in the region of the Earth [11].”

DEFINITIONS OF NEUTRINOS

THEY ARE OMNIPRESENT

[1] Neutrinos exist everywhere there is any such thing as “space”

THEY ARE AETHERIC

[2] They pass through material matter

THEY ARE PURE, STANDING-ENERGY

[3] Science measures **mass** as that which has an active electronic signature only. Those things that do not carry either a positive + charge or a magnetic - charge (BOTH are electricity, only in opposing currents which means the direction the energy is flowing) are considered to simply not exist. In the case of Neutrinos, the electricity it carries is simply inert or not moving in either direction because it is static electricity. Static energy is the **base-form of all energy** that enters into earth. It must be **activated** in order to “do something”, otherwise the sheer volume of Neutrinos (which are called ions once activated) that saturate earth every second of everyday would vaporize this planet and all other planets within the solar system if they were all activated instead of dormant. When you shuffle your feet across the carpet, the neutrinos or ions then pass from the carpet fibers into your plasma field that positively charge your physical body, and when you touch the doorknob or someone else, that energy is discharged. It is static until you create **friction** which unlocks the particle energy. It is also **friction** that will activate neutrino/ion energy as you will see in real-life, photographic form.

THEY BREAK THE LAWS OF PHYSICS

Decoding The Hive

creation of gravity, light, time and the god particle

[4] Neutrinos are “lighter than electrons”. That means simply that they are defying gravity, even though they do not carry an electromagnetic (oblong-spin) signature. As explained in the MAGRAV illustrations above regarding antigravity, the atom, which is a 3rd dimensional particle requires *imbalanced opposing forces* inside in order to give it **buoyancy**, but neutrinos do not pulsate or spin, therefore it does not make scientific sense that they carry an electric signature. They are therefore not considered matter, even though they exist. This is because at this stage they are aetheric, meaning they are not bound by the laws of physics that activated electricity is. Once electricity has been activated, then it becomes part of this dimension for want of a better term. They do not obey the law of gravity, because they *are* the sound waves that will literally go on to **power** gravity later once they have been activated.

THEY ARE INERT (LAYTENT) ENERGY

[5] Science is literally telling you in cloaked words that neutrinos can be weighed, meaning there IS an electronic nature about the particle, but it is in neutral (think your car). The engine *is running*, but the car is just not yet in gear. If it had no electronic nature of any kind, then science literally has no way to measure it, because no sub-atomic particle has actual weight to start with. Either it is energy *in some form*, or it isn't. That energy once it has **become** atomic **then** it can be measured as if having a gravitational signature because then it is finally supposed to **act** like it is affected by gravity. Sperm (and that's what neutrinos really are), don't weigh much of anything, but the being that will eventually grow from it, will.

THEIR POWER IS CARRIED BY THE BLACK SUN

[6] Neutrino waves are released by the sun. These are invisible waves that are neutral; they cast no light, no heat, and pass through all matter. They are frequency waves, not illuminated pixels (that disperse light you can see). And since every *wave type* called a particle is a photon (light), then you can understand that the color of its light is **black**. Sun “rays” are the **command codes** to bring energy in to power the spacetime fabric which was a command made by a Sentient being, cast into sound, and that sound is carried by the light. The light itself is in stasis until crystals blink on using the energy waves provided by that portal.

NEUTRINOS ARE THE POWER BEHIND NUCLEAR REACTIONS

[7] When neutrinos are created by a nuclear event (which is the splitting of an atom called **an atomic-particle** instead of **atom** when dealt with at CERN), they start with a *neutron* which is an *activated ion/neutrino* that has already had other ingredient particles added to it to bring it fully into the 3rd Dimension, making all those particles now subject to the laws of physics. When the neutron is then separated, what results is “*one electron (code word for activated ion), one proton, and one neutrino*”. If one neutron carries an electron and a proton plus a neutrino inside, it is obvious that the neutrino + ion is the

Decoding The Hive

creation of gravity, light, time and the god particle

glue that binds those other two together. Likened to a car that needs more than one quotient to move forward, you need the car (the *electron* or “*mass*” that can carry your weight), with an engine (the *proton* or power plant to burn the fuel), but without the neutrino + ion, the other two are just sitting there with no gas in the tank because the *neutrino ions* are the fuel that powers the proton.

[8] Neutrino Leptons – See **THE NEUTRINO CADΣ** Chapters next

ANTINEUTRINOS

[9] Each neutrino has a partner called an **anti-neutrino**, because there is no such thing as a material action in this plane that doesn't have a shadow. The shadow that someone casts, say on the sidewalk during the day, is not actually a shadow the way we think, because we think that the sun is casting light-rays and our body blocks those light particles from hitting the ground. That's not true. The crystals inside the water (carried upward by hydrogen that we now call **air**) molecules cast the light or illumination (as will be clearly covered in following chapters) and this action cancels out the light from below you which then reveals antimatter which is the lack of light. Where they cast their energy FROM is the “ground” you are walking on, and **project out** to the spacetime fabric pixels that is casting your image. This is antimatter. The symbiosis of whatever manifests from beyond the veil and into this material dimension. To put this simply, think of antimatter as little video projectors on the ground, pointing UP and projecting a hologram you can see. Because they are using their energy to project the hologram, they are now BLACK, or **lacking** their light from where the projector is located.

NEUTRINO OSCILLATION

[10] To remind you where we are at within our explanation of what Wiki has to say about neutrinos, the 10th reference was “*The three types of neutrinos change into each other over time, so an electron neutrino could turn into a tau neutrino and then back again.*”

This is called neutrino oscillation, meaning that no neutrino is in a singular stable state. All the leptons within what is called the neutrino family are “visiting with each other” for want of a better term. The particles exchange constantly between them which is illustrated below. Since they are not on a material mission at the moment other than coming here to see if they are needed, they bide their time, not holding any one pattern or form until the energy reserves need recharging (crystals). When they do, the neutrino seeks out an ion still in stasis, collides together and then atomic energy is then formed in both positive (+) atoms and magnetic (-) atoms. When a neutrino and a water photon decide they are going to “have babies” in the form of new ion atoms, then the neutrino comes out of its completely invisible state for a fraction of a second, just prior to their contact. When that happens and someone is at the ready to see this action, the neutrino

Decoding The Hive

creation of gravity, light, time and the god particle

prints a pattern in the water and CERN has taken photographs of this signature as well as the event once the two collide which I will be showing you soon:

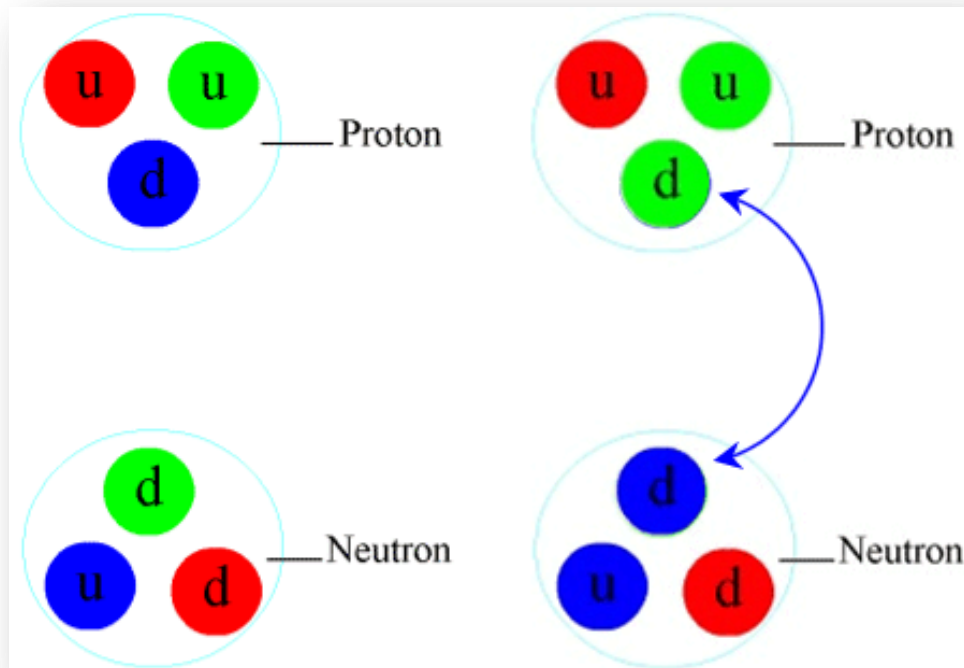

As long as none of the particles are fully formed as a complete unit, the energy inside each neutrino remains “alive but not active” or not yet expending energy. The down-quark and down-quark antineutrino (antimatter) continually switch places between the proton and neutron which keeps them both in stasis without flashing “on” like atoms do. Think of a cat that is vibrating or shaking, preparing to pounce.

NEUTRINO DELIVERY

[11] My final comment on the Wiki neutrinos explanation (prior to breaking down the neutrino leptons in the following chapters) is to explain the statement; “*Most neutrinos passing through the Earth come from the Sun.*”

This is the delivery vehicle that has access to this harmonic density. The sun is an interplanetary stargate (inter-**density**, meaning more than just one Harmonic Universe), not just an inter**dimensional** one (inter-dimensional as in within the 3 dimensions hosted by each planet in each individual Harmonic Universe), such as most of the stargates located on earth. It is not just a gate for interstellar traffic, but also allows energy to pass through into this quadrant of the Time Matrix from the Standing Energy Fields of god-source. The sun is merely a **geometric Keylon Template** held in the **Membrane** surrounding the planet (think tattoo pattern ⊗). The pulsed scalar-waves that feed energy in to keep this density alive come through the back-side of the sun (between planets)

Decoding The Hive

creation of gravity, light, time and the god particle

which is located past the final veil. There, it is a **black-hole** that continually brings in energy commands, then pulses through our sun and into this atmosphere.

When those sound-waves come through, they are invisible, just as radio waves or other microwaves. They deliver a pulsed-tone that is keyed to release energy that is stored up by the crystals in this atmosphere which then produce illumination. The pulse sets the time (metronome) for the flashline sequence that is the refresh rate by which you are able to “see” or “touch” anything. I won’t get into the complexities of our Chimera Reality where black is actually an off-white and off-white is displayed as black, other than to say that what your eyes perceive as brightness, is triggered by the sun’s rays and the energy held in the capacitors of microscopic crystals that are brought up into the atmosphere release light just like trillions of tiny light bulbs. The more of the sun’s direct scalar-waves strike the crystal, the more energy that crystal releases in the form of both light and heat. (Much more on the Chimera Reality will be coming in later volumes.)

Neutrinos and ions bring in the pure element of energy in totally independent form from one-another (both + and -). Ions are called photons by science prior to their initial activation which will happen only once a neutrino strikes or “rubs against” the ion, causing friction that releases the magnetic charge which is then carried by the ion in either + and - form. Prior to this however, both neutrinos and ions are delivered in quantum state through the sun portal, meaning they both are spin-neutral, yet both carry positive and magnetic charges. The neutrino acts as the male in the “friction” event, and the photon/ion acts as the incubator for the incoming energy, exactly as the female does giving life within the 3rd dimensional playing field. It is then up to the “mother” ion to go about dispensing that energy in measured amounts to every pixel within the playing field which we will cover much deeper as we go. It is the friction event that creates electromagnetic energy that has been symbolized to no end by the Sumerians as sex.

WAVES ARE RELAYED

Coming up soon we are going to look into the **SYMBOLS** that have been given to elementary particles that neutrinos “break down into” called leptons. Their delineation is called “decaying” in scientific-terms, when a particle goes from one form to the next, but as already mentioned, there is no such thing as decay, there are only mission parameters. As a wave is sent in to refresh the energy for surface-earth of the 3rd dimension, it is supposed to “go here and do this”. **That wave itself WILL NOT personally be travelling from the sun to the center of earth**, then come back again to the Deity Planes. Only the light carrying the sound created by the message itself will relay the command (as in “*In the beginning was the word*” which was technically “a command”).

A Sentient being will cast that *thought* into the aether, and that sound will run a “relay race” to see that it happens. The message will be handed off from one pixel to the next like a water brigade line passing one bucket down the line, or like people sitting in a circle playing the Telephone game, relaying one sentence into the next person’s ear. These are **tiny** vibrations that make **tiny** sounds that can be heard “1/10,000th of an inch” away to the next spacetime fabric

Decoding The Hive

creation of gravity, light, time and the god particle

layer, so imagining that sound waves or light waves “travel” is merely a distraction from the actual process of how a command makes it from one side of the playing field to the other. Leptons don’t actually delineate into anything, but the command will indicate that certain pixel crystals will change course and flash differently from the previous one in order to emulate *rust or less green, as the leaf is now turning back into mulch at this stage.*

This is the single-hardest concept to understand in this entire report. No other notion is more difficult to grasp than the idea that nothing is real and nothing actually moves more than “1/10,000th of an inch”, and even those are nothing but sound waves. Baseballs don’t actually *move*, leaves don’t really *fall* from the tree and birds don’t actually *fly*.

100% of every single thing that displays movement of any kind are merely chaser-lights being relayed by light-bulbs.

Some light bulbs just remain *glowing grey* for *10,000 years* as the rock just sits there, and others change from the color of your elbow to clear air the next second as you reach out to do something. This means that every observation you have ever had about how things work is based on the lie that there is such a thing as matter. There are computer screens even TODAY that not only show you a rose on the screen, but you can smell the fragrance of that rose at the same time, because the colors that are being flashed on the screen carry a much more **complex** frequency of a rose, not just colors that are *sort of like* a rose. When that **full** harmonic frequency is achieved, then the rose on the screen that is “suspended in the air”, will physically drop to the bottom of the screen, because the **full signature** of a rose carries the scent of a rose, and the **gravitational signature of the density of a rose** as well. That sound can also just project the **color without the scent** or the “mass” without the **density**, etc. as our televisions do now. And it doesn’t matter if it is on your screen, or “in the sky”. If that frequency signature is projected, then every pixel around it will **act** like a rose on every conceivable level, regardless of what generated that sound.

Sound that generates scent has been in use even by mankind (I should reword that to *even by Masonkind*) for decades as mentioned elsewhere within this series already penned. McDonalds has been broadcasting the scent of frying burgers and fries out of their golden arches to trigger salivary responses in pedestrians since the 1970’s, but because it *seems close* to the actual building, you assume you are smelling real kitchen fragrances. Such technology is commonplace in other eras and civilizations, but in this one, you are simply not allowed to know about such things yet, because that technology doesn’t just mean that your TVs will be able to bring you into the movie more vividly, it reveals the truth that you live inside of a hologram, which is the greatest fear your captors have. Once that genie is out of the bottle, the entire Chimera Reality will begin to collapse. I intend to pull the first brick out of that house of cards with this report by showing you the physical mechanics of **Scalar Vibrational Science** in surface-earth, scientific terms that people can understand. It won’t be simple, and these coming chapters might push you to the limit to follow, but when I say it is worth the investment to learn, I **really** mean it.

This is why particle science cannot attribute the action of the electron or the proton core of leptons as doing anything unique independent from one another. They are only able to identify that there are multiple things going on within the neutrino which they simply call *flavors*.

Decoding The Hive

creation of gravity, light, time and the god particle

However, they have attributed *4 distinctly-different symbols* to the one neutrino anyway, and that has to do with the **Keylon Primal Command Signet** symbols behind this element of the friction event process which I will turn my attention to over the coming chapters.

I will be using labels and references that will be in human-science terms, such as in particles that “activate another particle”, or “bind a group of particles”. All of these are misleading, because *neutrino Lepton Electrons* do not really exist. This is an extremely complicated **Program** the invader races have put into place to confuse everyone looking at any level of what **neutrinos** or **ions** or **atoms** do. There is one kind of particle; an **aether sound wave**. It carries the song of its mission given to it by a self-aware fractal of god source, so it will take the shape of or act like a neutrino, a lepton, a Higgs Boson, or an atom this fraction of a second, and then it will hold the color of someone’s fingernail cuticle in the 12th dimension the next fraction. I only mention this so you can keep in mind that what these particles supposedly do are all constructs handed to scientists by their captors who are only trying to confuse them every minute. Particles don’t exist, but we are going to act like they do over the coming pages so I can explain to you how it is each action that takes place has been given a **hierarchy** by your captors, and the really important actions have been labeled and given **graven images** to depict which deity to attribute that action to.

*Graven images carry scalar wave commands that power **Programs** put in place by your captors. The reason you are never supposed to make graven images of your gods, is because they already have their own graven images they want to use against you as trotted out by their priests. THEY can use graven images until the pigs come home, but YOU aren’t supposed to have your own. If you decide that you want your “god of water” to “act like this from now on”, and you make up your own SYMBOL for that god that will now act differently than before, then your **Keylon Command Signet** will be in direct opposition to their Keylon Command Signet they already have in place to represent that god (action). You are supposed to use **Jesus on a cross** because that way when you die, you will automatically be mentally coded to the white recycling light without any fuss.*

*Water, wind, the sun and fire are colors blinking on and off on a screen. Just like you are blinking on and off while reading this, and the letters in the words are blinking on and off as well. There could be 8 trillion different types of particles as far as science might be concerned, but in reality there are innumerable Sentient beings all from one family called god who are acting out either a mortal existence (like you are now), or manifesting as a tiny crystal to serve as a capacitor/light bulb to relay holographic energy within a Time Matrix. Otherwise, the only other things that exist at all are Sentient beings (self-aware fractals of god source) who have chosen not manifest at all. That’s it. There is nothing other than those three things in all of space and time and beyond. I elaborate on this issue only because it is so utterly foreign to our way of looking at things that make it almost impossible to accept the fact that all the standing energy field beings are doing is blinking one color at a time inside of pixel frames that are invisible until they spark. That’s why I say to consider everything within *all that is* as just like being inside your TV or computer screen, because lights blinking yellow or red or green or others is all there actually is outside of *awareness* and *energy* alone. And the *energy* is literally created by that awareness, so in real terms, **only awareness that is energy** is all there is in all of creation.*

Decoding The Hive

creation of gravity, light, time and the god particle

The aware fractals of god source **think**. When they **think**, their thought creates a **spark**. The spark makes a **sound**. The sound carries the **fully body** of that thought. Other fractals of god source **hear** that sound and then work in harmony to create what that original self-aware fractal of god would like to see, and they use **Scalar Vibrational Mechanics science** to go about blinking a **color** just for that fractal of god. The light they blink comes from the spark created by their thought that they want to be a part of your vision. The *awareness* within each fractal of god source is what makes up the **Eternal First Fields of Light and Sound**. Their awarenesses are literally the **source of the energy itself** that powers the play. It is their working together in harmony that creates the symphony that makes up all things we call creation. Don't worry, I will be rewording this same exact explanation in other ways so you can understand it if you don't already. No matter how smart you are, this is not an easy topic to grasp. Once you see how the fabric of spacetime is generated, it will be easier to see how the hologram is projected.

CHAPTER 21

THE NEUTRINO CΔΔΣ: LEPTONS V_e, V_μ, V_τ



By the end of this segment, you will be very clear about why the image of Poseidon is heading up the **NEUTRINO CΔΔΣ** chapters. Poseidon didn't *live in the sea*; his power came **from** the sea. Otherwise he preferred nice dry accommodations without the constant rocking. The ocean, in scientific, technical terms is a **gigantic** capacitor storing energy far beyond the ability of man to calculate. The electricity in even a small salt water lake such as the Dead Sea is more than

Decoding The Hive

creation of gravity, light, time and the god particle

enough to vaporize this entire planet, much less the energy held within the expanse of the entire oceans of the world. Even a single cup of salt water could power all the needs of a metropolis for a full week as long as you know how to access that energy. Trust me, the people claiming to hold the title of Poseidon, Triton or Neptune knew all about it. If you think the Sumerians (Phoenicians, Canaanites, Egyptians, Etruscans, Romans and Greeks) lived on the edges of the Mediterranean Sea by random accident, you aren't following along.

In the last chapter I broke down the explanation about neutrinos given by Wikipedia, which is an official synopsis for how modern science accounts for these subatomic particles. We skipped over the 3 additional symbols for neutrinos that were added to this elementary particle under the heading of **neutrino leptons** because this is too vast and important a topic to address in only one chapter as you will see. There are powerful clues to how the game has been played by your captors, giving them the ability to bring down the hammer of god from the heavens that are revealed in the symbols of the official explanation of what atomic and subatomic particles are and what they do. I will re-paste that portion of the Wiki quote here.

Wiki: Neutrinos;

"...The 3 types of neutrinos are named after the previous three leptons. There is the electron neutrino (ν_e), the muon neutrino (ν_μ), and the tau neutrino (ν_τ)."

Remember, the neutrino electron, muon, and the tau all do exactly the same thing as each other at all times, so we are not talking about *different particles* here, we are talking about ONE particle (wave) doing 3 different, **aetheric** things. The particle that is called a **deuteron-water-air-photon-hydrogen-oxygen** and then also **ion** by science is the most important particle on the planet, **Deuterium**. But until the "*holy spirit*" it carries within the microscopic crystals within its liquid shell is activated or unlocked, it simply sits there like a princess locked up in a tower. It is and always has been worshipped by **Hermetic Initiates of the Golden Dawn** (therefore by every secret society across the globe), as the god of all gods. However, due to the fact that this is the most hidden secret ever spirited away from mankind, it is the power of the particle that *unlocks* those priceless energies that has been visibly deified before the masses, the sun.

All that stands between the powers of all of the cosmos coming into service within this manifestation field that is held inside Deuterium is the sun's frequencies we call *rays*. Therefore the KEY to power has always been *the burning ball in the sky* that neither burns, nor is a ball. It is simply a geometric Keylon Template positioned within the Atmospheric Membrane that is constantly circumnavigating earth's highest point above the playing field, passing along an aether command put in place by various collectives who have fiddled-with, damaged and then replaced that Template numerous times throughout history. It acts as the *valve stem* that allows the sound waves of earth's life commands to come in through from a recording that is set on **replay** that spreads that sound to all corners of the field like the hands of a chronograph overshadows the dial below. Science calls those waves **radiation-gamma rays-neutrinos-pions-mesons-muons-leptons-electrons-tauons**, and you call it **sunlight**. So this section will be declassifying both the **cover god** of the sun (the distraction) as well as the true "deity" of **water** (their secret god), and their **combined reactions** to each other which have been hewn into symbols under different names that have been **physically** used within the **Keylon Template**

Decoding The Hive

creation of gravity, light, time and the god particle

Command Signets associated with the **Cronus Program** that regulates the **flashline sequence** of the 3rd dimensional hologram that dictates all the life that *apparently comes from the sun*, as well as the amount of days you are allowed to experience.

Down below every spell cast across civilization since the very first Atlantis (Alania) 560 million years ago, through the **talismans** of numbers, letters, hieroglyphs and scientific symbols, lay **particles**, and particle physics *is* the very genesis (the **GENE** of **ISIS**) itself to the **S@t@in Cυphxr**.

THE NEUTRINO CΔΔΣ: LEPTONS V_e, V_μ, V_τ

[8] Neutrinos are subdivided into compartments called Leptons, with each division individually scientifically coded with the symbol **V**. **Electron** = V_e , **Muon** = V_μ , **Tau** = V_τ . All three types of Neutrino Leptons are coded with **V** first, with their following symbols to define their particular roles called **flavors** as mentioned. This is not just a minor, **bit-player** in the **Science Cipher**, as you will see.

Leptons are **neutral** in electronic charge. This is significant, because all three neutrinos are rated with no electronic signature, meaning they aren't considered positive and they aren't really considered negative. Like god, somehow they just *are*;

Wiki: Neutrino;

*“A neutrino (/nu:'tri:nov/ or /nju:'tri:nov/) (denoted by the Greek letter ν) is a fermion (an elementary particle with half-integer spin) that interacts only via the weak subatomic force and **gravity**. The neutrino is so named because it is **electrically neutral**.”*

This makes all three leptons **V** (code symbol for the **Trinity**), as in **electrons** which are deemed as negative (-), but at the same time, the energy inside certain neutrino fractals called **leptons** such as the **Muon** V_μ , is **200 times** and the **Tau** V_τ is **3500 times** as powerful as a mere atom. Neutrinos are neutral and ions are neutral according to science. But in truth, the signature of **neutrinos** is carrying the (+) **positive** energy that releases magnetic electrons (-) from water ions. So whether they are neutral or not, they act like protons when interacting with neutrons when it comes to releasing oxygen and hydrogen from Deuterium ions. Conversely, the **ion** is known to carry **magnetic** (-) energy once it begins doing something. This makes the **neutron** (the *rays* of the sun) the Hermetic **Red King**, and the **ion** (water) the **White Queen** (explained shortly) for your frame of reference before we begin. When we are finished with this topic, you will see quite clearly why **V** is a **transgender** symbol, and why it is used on this particular particle.

Both male gods and female gods of the most ancient of times were always **androgynous**, the same way both of the wave-types (neutrinos and ions) that come together to *make baby atoms* carry both positive and magnetic charges inside them. This literally makes

Decoding The Hive

creation of gravity, light, time and the god particle

the Red King and White Queen interchangeable in much of their **Signet** symbols within the **S@t@in Cyphez**, but there are still codes within each that differentiate them on occasion that spells out just who is really who when it comes to the real power.

Also, keep in mind that sun waves (neutrinos) are **sound command codes**, and the crystals that carry the power of the ion (Deuterium) are **physically manifest** as multidimensional **Sentient Spirit Essences** within this playing field. So we are talking about two different things, at least within the construct of the material, 3-D dimensional world. The multidimensional sound of the command by the sun replenishes the energy inside the crystals of Deuterium. Crystals that function as the energy source for all life on this playing field are “recharged” (circulated) by the neutrinos, which is held inside the liquid of **oil** first, then are transferred through the process of **SET** (Static Electric Transfer) into **Deuterium** (water) which steps-down the voltage that will be utilized across the surface-level of the planet above. The entire process will be explained in detail once we establish what the different scientific **terms** really mean and what the different scientific **symbols** really stand for. This will help you compartmentalize in your mind how all of this works as we fully vest into our journey through particle physics.

LEPTON ELECTRON V_e

The **Neutrino Lepton Electron V_e** has already been covered in-depth under the section **ADAM AND EVE AND ELECTRONS**, because the subject of **Electrons** literally means **neutrino lepton Electron**. **All electrons come from neutrinos**. This means that all electrons only exist because the sun continues to “shine”, because all neutrinos come from its frequency waves. But of course that isn’t mentioned in any common definition, because disassociation and misdirection is the very name of the game when it comes to any higher levels of information. While particle physicists might know this truth, the everyday person will spend at least hundreds of hours if not more getting down to that fact. Electrons are multidimensional particles that are somehow part of all 3D atoms, all lumped together **as** an atom while in this form, then ambiguated across all other references. The fabric of material existence is made up by this particle within scientific analysis, even though it only acts like an atom for tiny fractions of a second at a time. While it isn’t holding the shape of “a spoon”, it is simply *not here*. If there were such a thing as a *holy ghost* within particle physics, it would be this particle that plays two roles at all times. The **V Signet** that stands for Electron, as you will see as we go, stands for half of the equation to the intensely obscured **phantom** Higgs Boson that is openly referred to as the god particle.

The power inside the electron is nothing compared to any disambiguation of the lepton family. It encircles the core of the atom while in 3-D (flashing) form, and rests as merely an essence while cavorting with neutrinos who then all remain resting or inert. It is merely a *light switch* for the resting powers inside, as you will see more of later. The light switch can be thought of as the part of the god particle that receives and then shares the incoming message from the wave of any one mission. When it hears that command, it

Decoding The Hive

creation of gravity, light, time and the god particle

then simply flips on the connection between the resting neutron and proton inside the crystal, allowing that *light bulb* to *shine*. The neutrino electron is the match, and the energy held inside ions (usually just referred to as either oxygen or hydrogen or both) is the fuel. Electrons are *conduits* for powerful energy to perform.

LEPTON MUON $V\mu$

Just like the electron, the **Neutrino Lepton Muon $\nu\mu$** is also rated with a negative electrical charge, however the “flavor” of the Muon has 200 times as much “weight” as an electron, which means it carries serious power. Indeed, all 3 neutrinos fall under the ultra-unique category of **boson** which is a code word for **multidimensional**. They don’t act like atoms, yet they carry the signature of atomic force, called the **strong force**, that science can’t unlock without blowing them up in a nuclear cataclysm. Neutrinos *mediate* (control) the actions of 3-D atoms. There are *atoms*, then there are *elementary particles*, which are completely different from each other, yet both carry energy. Atoms make up material things, and *elementary particles tell atoms what to do*:

The God Particle and the God of Particles by Wayne Spencer:

*“The bosons are referred to as force mediating particles because they are all related to fundamental forces. Leptons include electrons, positrons (the **anti-particles** [which means **opposite**] of electrons), and three types of neutrinos which are very low mass particles.”*

When you look at particles that are static, you see particles in non-spin (non energetic form), that transfers a particle between both sides of the dormant cells, back and forth, keeping them inert but awake and ready to act. Science calls this particle a **Pi meson** or pion which is a gluon (now carrying the **strong force** along with the electron power surrounding the additional particles that have now joined the mission of 3rd dimensional participation while in *atomic form*):

Wiki: Pion [Pi Meson];

“In particle physics, a pion (or a pi meson, denoted with the Greek letter pi: π) is any of three subatomic particles: π^0 , π^+ , and π^- . Each pion consists of a quark and an antiquark and is therefore a meson. Pions are the lightest mesons (and, more generally, the lightest hadrons), because they are composed of the lightest quarks (the u and d quarks).

*Charged pions most often decay into muons and muon **neutrinos**, while neutral pions generally decay into gamma rays.*

*Recently, the detection of characteristic gamma rays originating from the decay of **neutral pions in two supernova remnant stars** has shown that pions are*

Decoding The Hive

creation of gravity, light, time and the god particle

produced copiously in supernovas, most probably in conjunction with production of high energy protons that are detected on Earth as cosmic rays.

*The concept of mesons as **the carrier particles of the nuclear force** was first proposed in 1935 by Hideki Yukawa.”*

Gluons are the “glue” that keeps these dormant energy cells in **stasis** and the Pi meson has been shown to be the particle that carries the **strong force** itself. It is a *flavor* of **neutrino** just to be clear. Science admits that neutrinos have **no separate particles inside**, but that one magic particle is doing these three different jobs. They simply separate out all these actions as totally different particles and give them different names for the purpose of studying them. But in real life, this disambiguation is for the purpose of assigning very specific actions to **Command Signets** so their different energies can be assigned to different Commands just like using 6 volt batteries in a small motorcycle and a 12 volt battery in a massive truck. The most demanding, *biggest-picture* **Command Programs** are assigned the **most powerful** subatomic particles to power their missions.

As a refresher from previous, the **Pion** or the “**d**” particle below is the DOWN quark (-) that changes polarity as it transfers back and forth between the proton and neutron, changing from quark to **antiquark** (matter-to-antimatter). As soon as that quark leaves the cluster of the proton to the neutron cluster and unexplainably transforming from matter to antimatter, that action is called a **Pi** meson that powers both clusters as it arrives. This means that the Pi is the magic particle where nuclear energy comes from, and it also means this is a multidimensional particle that is not strictly bound to earth alone. This is why you will see later, it was named “meson” and why the most powerful secret group on the planet today is also called mason (same title and same ancient symbols, but the common folk have yet to be educated on exactly where grapheme letters came from and how they are used today as cipher signets to hide the provenance of where such titles originate so you will be unable to trace their origins):

Decoding The Hive

creation of gravity, light, time and the god particle

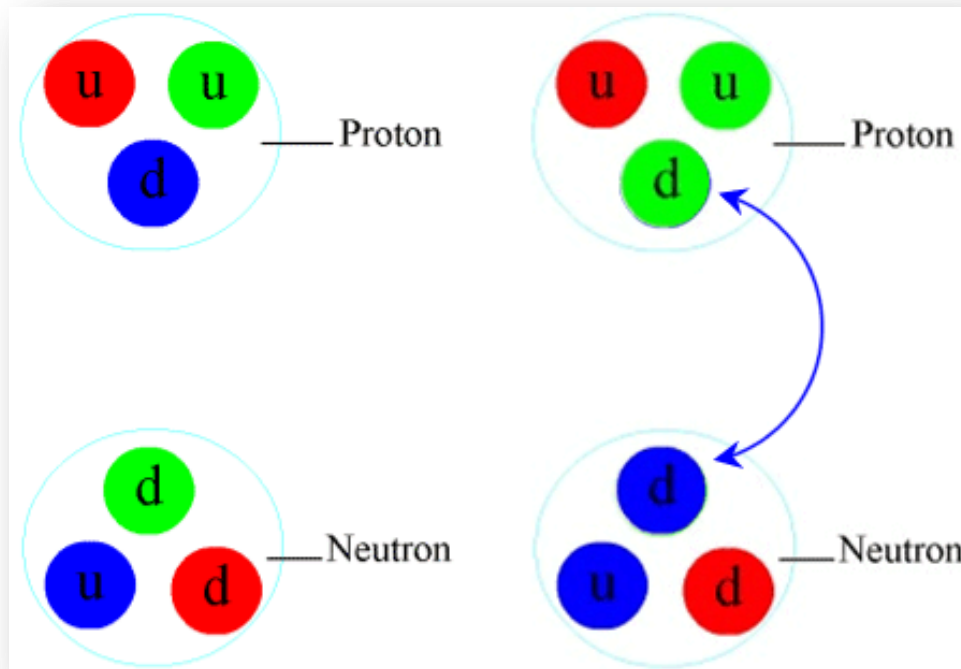

Running water remains vital, awake. Static water becomes stagnant and spoiled. Both opposing energy cells that together make up the ONE atom must remain awake and at attention, even though they are not yet actively on a mission to hold the shape of a leaf or a chair. They are in stasis, alive but not acting. I have seen my contact in stasis, so I am personally familiar with “alive but not breathing”. It is a zero-point transformation that places the body outside of the spacetime of material animation while remaining physically within this dimension. In the section **TURNING INTO AN ATOM: ANTIGRAVITY**, we covered how anti-gravity works, and within that explanation you see that the zero-point is achieved by perfectly-harmonized particle-spin that removes certain limitations of the 3-D laws of physics from that body. Neutrinos (**Pi** mesons, etc.) are in perfect-spin as you will hear MUCH more about as we go, suspending them from the limitations of gravitational influence that atoms are absolutely bound to.

The fact that this particular element of the neutrino Lepton family is named after FreeMasons, or that it is also referred to as **Pi** isn't surprising, as the Masons have honored power above all other things since before time was even recorded. The force behind the Catholic church where the **pious** priests congregate has always been the Masons known more universally as the Knights Templars today. They are referred to by the church as the **Order of the Poor Knights of Christ and of the Temple of Solomon**, who were christened as the official plain-clothed standing army of the church of Rome through the Papal Bull of 1139 by **Pope Innocent II**, under the order of "**Omne Datum Optimum**", in case anyone might be wondering if Masons are actually covert military agents or just a harmless fraternity. The man credited for the discovery of the **Pi Meson** just so happens to be the famous physicist **Hideki Yukawa** who was accused of being a

Decoding The Hive

creation of gravity, light, time and the god particle

traitor that sold Japan's top-secret technologies in the development of the nuclear bomb to the US.

“**Pious**” refers to Catholic devotion to the great saints of old:

Wiki: Catholic devotions;

*“Catholic Church considers the liturgy as central to the life and mission of the Church and encourages Catholics to participate in it as often as possible, it also acknowledges the objective nature of the liturgy and encourages the cultivation of pious acts and personal devotions... Devotion to saints, with the **Virgin Mary** as the most prominent example, is a key characteristic of Roman Catholicism.”*

MASONS ARE MESSENES

As will be elaborately demonstrated here, the Virgin Mary is merely the modern-day name for the original Sumerian universal god of life, **Wawwu**. The connection between this absolutely **fictional** god and the chemical actions of neutrinos and ions is more than just overwhelming as you will see soon. Between “Jesus”, “god” and the “Holy Ghost” of the Trinity and including **all past Saints**, it is the **Virgin Mary** (the real holy ghost and the Pi Meson) that pious devotion is most often directed. The naming (**titling**) of the carrier-action of the strong force of neutrinos as the **Pi meson** is a *direct* glorification of the **Trinity** which **Mother Mary** stands at the head of. We haven't even scratched the surface yet of the mountain of symbolism used to honor the gods within the signets and titles given to the *fundamental* elements. The **lie of Pi** intertwines throughout all mathematics, science, education and virtually everything related to what is passed-off as higher knowledge today and the **Science Cipher** plays a *heavy role* (arguably the most significant role of all) in the **S@t@in Cϕphϑr**. The Pi meson was literally named after the ancient religion of the **Messenes of Greece**, original home of the Masonic Order which is secretly the **Messenic Order**.

- The god of the **Messenes** (Masons) was **Jupiter**, his symbol is the **Trident** ⚡
- Jupiter is **Zeus**, supposed brother of **Poseidon** Ψ
- Zeus is **Marduk Satain** Ψ:

Decoding The Hive

creation of gravity, light, time and the god particle



- **Marduk** is *owner* of the **Catholic** church known as **Lucifer**, **sun** of god
- This is the **Signet** of Saint Paul: Ψ
- The **Vatican** owns the 13,500 yr old **pitchfork of Lucifer**:



Decoding The Hive

creation of gravity, light, time and the god particle

- The term **Lepton** was a transliteration of the word **Neptune**, god of the sea: Ψ
- Neptune is another name for **Poseidon**: Ψ
- The Pi Meson is the triplet-spin (holy spirit) particle of **hydrogen** from **Deuterium water** which is a Neutrino **Lepton Muon Pi Meson**
- **triplet** is spelled with a **t** which is a **Trident**
- When a **Pion** recharges an **Ion** the shape it makes is this:

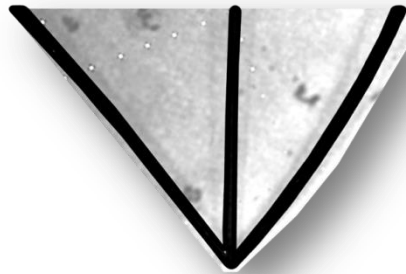

- The scientific symbol for the **Lepton Pi Meson** is: **I** as in **Ionia**
- **Messenia** and original **City State** now capital of Peloponnes, is **Ionia** in Greece
- The original proto-Siniatic symbol for today's letter **I** was a **Y**: Υ
- The early Greek symbol for **Y** was the original **trident**: Ψ
- The modern Greek symbol for **Y** in Greek symbols is the **Trident**: Ψ
- This is the **Freemason Lodge #67** symbol **Trident**:



- The secret hand gesture of Masons is the **Trident**:

Decoding The Hive

creation of gravity, light, time and the god particle



- What is lesser-known, is this is the same sign. The **Taurus**, or Bull of Ba'al (Bull of Utu) flash is actually shielding the middle fingers in the same third (but hidden) point of the **Trident** also known as the **Trinity**:



Decoding The Hive

creation of gravity, light, time and the god particle

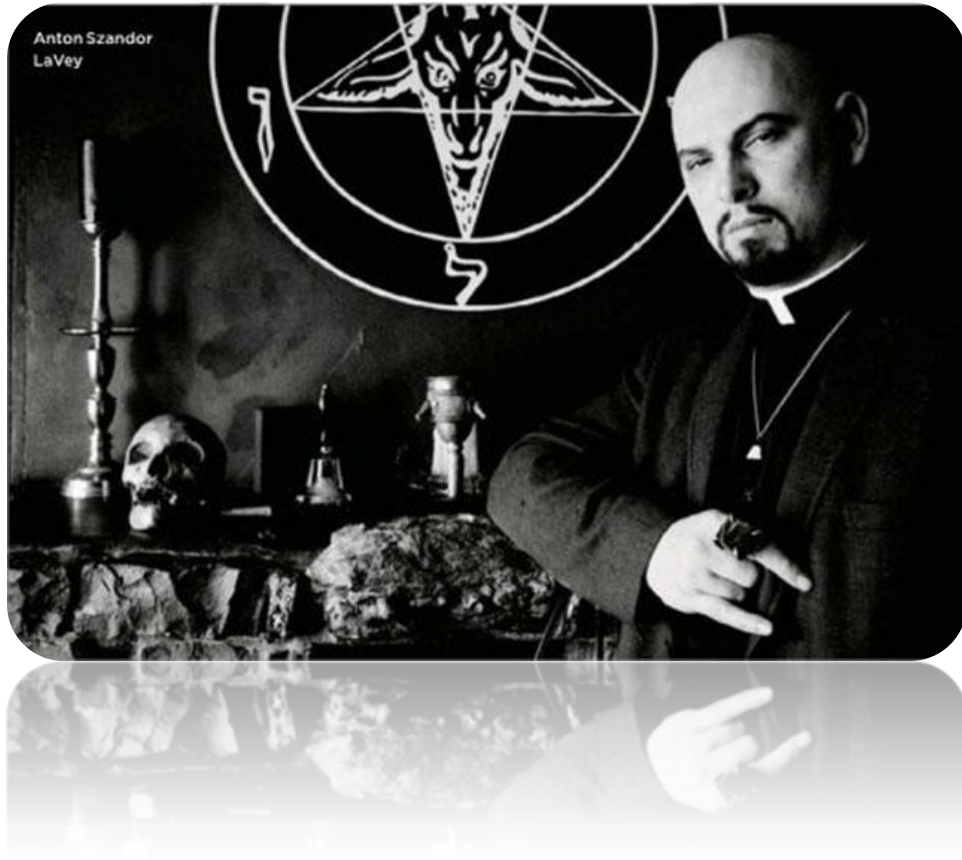

Decoding The Hive

creation of gravity, light, time and the god particle



- This ancient **Messenia** Greece coin from 600 B.C. shows both the **Trident** also as the three-points of **M** as in **Mason**, **Mary** and **Marduk**, all upside down **Ws** as in **Wawwu** who was literally called **Mamma**:

Decoding The Hive

creation of gravity, light, time and the god particle



LEPTON TAU $V\tau$

Like the other two neutrino particles, the *tau* ($\nu\tau$) is also called a lepton; Ψ , or an *extremely small particle*. Keep in mind, only *electric energy* is possible for them to measure when it comes to their claim of *mass* (simply because that's all there is at the quantum of anything), but since the lepton doesn't actively hold the shape of something, it is simply called a small particle. But that directly conflicts with the energy hiding inside:

Wiki: Tau Lepton;

*"This means that they are believed to be so small that they can not be divided any more. Tau leptons can be thought of as **very heavy electrons**, as they are both leptons. This is because they have about **3,500 times as much mass as electrons**, and about 17 times as much mass as muons."*

While stating that the particle is *small*, at the same time it carries **3,500 times** as much energy as a simple atomic electron. The frequency-band that this energy is within is lower, but the energy signature is wildly higher than found in a mere atom. This is energy in its most powerful form. More:

Tau Lepton Cont.;

*"Tau have a charge of -1, and can be written as τ^- . Since **antimatter has the opposite of charge of regular matter**, anti-tauons have a charge of +1, and can be written as τ^+ . Tauons themselves are unstable, and can decay. Also, τ^+ and τ^- can annihilate each other in a form of decay. When a single tauon decays, it is the only lepton that can decay into hadrons (things made of quarks).*

Decoding The Hive

creation of gravity, light, time and the god particle

*A τ^- will quickly decay into a tau neutrino and a **W boson**.*"

It is important to note here, that Tau leptons are actually **bosons**. A boson *breaks the laws of physics* by taking up the space of another boson. In fact there can be any number of bosons that share the same space as one another. This is because it has not yet *come into this dimension* by activating the **ion** that holds 3rd dimensional energy. Until the **Tau** interacts with the **ion**, it remains in stasis, just as *all three types of neutrino leptons*.

CHAPTER 22

THE NEUTRINO CADΣ: HOLY TRINITY



Here we get deeper into the **Science Cϣphϣr**. The **V** Trinity symbol for neutrinos stands for **THE** power of *mother* god, the ONE or highest power within the material world. This also is the Trinity I speak of at great length about in this report, as the 3 points of the V and the Trinity represents the three actions that bring aetheric energy into what we consider real. One of these is the neutrino, one is water and one is the Holy Ghost, but understanding the science of how that

Decoding The Hive

creation of gravity, light, time and the god particle

can be true and factual takes some decoding. This is not a conjecture, but until the evidence is presented, it can't help but appear that way. Remember, the number 3 is the "culprit" of why math flatly refuses to work, and it is backed up by the 6 and the 9 which are all just simply multiples of, therefore versions of, the 3. There is a disconnect between 3 and math actually functioning, just like there are constant references back to the 3 all throughout science, because 3 is the platform by which the coma has been put into place. It is the apple that Sleeping Beauty ate that placed her into her eternal stasis. That apple is the Torus field (the plasma body) of the Divine Blueprint of the Angelic Human. Little wonder that field is named after the guy who put it into place, Taurus Marduk, the Bull of Utu, the Babylonian Bull of Ba'al. The missing L in Balal today is the missing ONE of the Elohim. These are not coincidences, and they are not stretches of a deluded conspiracy theorist to link them together to paint the big picture, they are real clues left on purpose to prove we would never get to the bottom of the real story.

The Neutrino is made up of 3 different actions referred to as particles, which are not particles as you already know, but all 3 neutrinos are **a single entity** with 3 different personalities or characteristics called **flavors**, even in their own parlance. Even though the Neutrino title begins with an N, *its scientific code* starts with a V *in all three sub-atomic actions* as mentioned above. Of course we simply assume the V stands for Voltage, but I assure you it **does not**. It is actually the Greek letter for the title **Mu**, (**M** as in *mother*) and literally stands for *magnetism*.

M is factually the original symbol where the trident came from itself that stood for Sal(t), the Sumerian name for **water**: ∇ . Later, after grapheme letters came into use, the "tail" was slid down and the top line was simply eliminated by Phoenician times: Υ . In early Greek it was simply shown as: Ψ and only in much later times was it changed again with the tail simply extended back down once again just slightly to: Ψ . The three points of the trinity have always been there, even by the Phoenicians, as the bottom of the Y was the third point, just as it was used during Roman times as the simplified V. The modern M was the original W in Wawwu which always stood for **water**, because two Vs created the bond, or the contract between the Elohim and the earth-level sycophants who do their bidding. One V is the Vector symbol for the Elohim, Two Vs created the W which is simply the letter M. On its side, it is the Elohim Σ , and reversed it is the number 3. Surprise. W is the one symbol that stands for the two letters AN, but denotes the inference of the inclusion of the matter-world people who place themselves bathing in the spotlight as the "prince" or "son" (representative) of the god in heaven, the Michaelube. You might want to have a piece of paper and pencil handy in order to follow this.

This is where the *serious* confusion begins, how symbols from incredibly ancient times have switched and changed, inverted, reversed, mirror-imaged and then laid down on their sides, switching between one civilization the Sumerians established to the next, all different but all still meaning what they stood for from the very beginning, but each civilization used it for different everyday meanings. Unless they were talking about "god"; and then it reverts back in uniform lockstep with each other. This is why when you try to type the letter **v** using Greek Symbols, it prints out ς . To type the letter v, you must hit N instead, and yet the Mu that actually stands for the real symbol of v starts with an M, not an N. What??? This is because the **title** of the letters we use has been hidden, then hidden, then hidden again. But on top of this, when it comes to deciphering *scientific* applications of Greek symbols connected to quantum mechanics particle reactions,

Decoding The Hive

creation of gravity, light, time and the god particle

absolutely *all bets are off* to find the answers unless you are willing to wade through the seventh circle of hell to get to the truth. You have to go back to the god **title** to find out what letter should be connected to it, and then find out through ancient uses of pictograph *symbols* to find out which modern grapheme *letters* actually stand for *each letter* within the titles as *numerically-assembled*. Let me give you an example:

Let's say you look up through a web search "*the letter V for scientific symbols*" to find out what it actually denotes and you are directed to **Nu** (as you will see in a minute), showing you that "**Nu**" is the Roman lower-case letter **v** today, but you learn that it is actually *printed* in Latin as **Ni** but "*transcribed*" as **Ny** (actually written out). You see that in Greek, N is N, but the **μ** is *printed* in Latin using **u**, which *means v* but it is *actually* the letter **i** but that is *SHOWN* as **y**. And let's say you have already broken the alphabet code after 4 years of schlepping through one type of cryptographic cipher algorithm after another and you know goddamn good and well that **μ** and **u** and **v** and **i** and **y** are all the exact same letters, and they had nothing to do with the flagrantly benign "*well?*", "*so?*", "*so what?*" as the official meaning of the Greek word that **Nu** carries. Now you have to somehow get past an absolute *firewall* between "**Nu**" and "**v**", so you have to go back through 10,000 years' worth of 200,000 civilizations' use of written letters and symbols in order to find out exactly where the hell **v** came from and why "*so what?*" is the term it now stands for today when it represents the foundation of all astrophysics and *rocket science* itself (energy). V is the VECTOR symbol used in 100% of **all** space program **Signets** around the world today, naturally it is going to be the most hidden of all.

All **science** symbols are **Greek symbols**. **Greek** is merely another hijacked name used by the **Sumerians**.

*And we say "that's all Greek to me" today, laughing this off as some sort of anomaly that "just happened" in language history, as if Greeks are a bunch of morons who need "how many Greeks does it take to screw in a lightbulb?" jokes made of them. But it is WAY more complicated than that. The beings that came to Greece and gave them their alphabet were NOT Greeks, in fact they weren't even human at all. And the alphabet was an incredibly sacred language that actual Greeks could NOT be allowed to have and use. Thus, there was one "Greek" (TOTALLY fake) alphabet for the people, then there was another alphabet for the priests (called "scribes"), now called "symbols". You could use "Greek" letters to communicate, but you sure as hell could never converse coherently in a courtroom intoning them unless you knew what those letters when assembled into a word actually meant within the context of the true alphabet the **priests of the color of law** use.*

MU OF MUON = VOLTAGE

I broke through that firewall, and you will see how I did that to find out why V now stands for electricity and energy. For now, here is the real **title** to the letter V, **Mu**. (Let

Decoding The Hive

creation of gravity, light, time and the god particle

me just say that if I were going to hide the most important letter that has ever existed for the past few hundred million years, I would call it “*so what?*” as well.) Notice the “Modern Greek” for Mu is the tiny $\mu\nu$ ← that last letter is the real V, and in fact it is technically VV back-to-back (as in W, as in the name of the *earthly*-level god-of-gods Wawwu). I am just showing you this now so you can keep this in mind as we traverse the cipher that is now modern-day science:

Wiki: *Mu (letter)* “ μ ”;

“*Mu (uppercase M, lowercase μ ; Ancient Greek $\mu\omicron$ [mý:], Modern Greek μ or $\mu\nu$ [mi]) is the 12th letter of the Greek alphabet. Mu was derived from the Egyptian hieroglyphic symbol for **water** (𓆎), which had been simplified by the **Phoenicians [Sumerians]** and named after their word for **water**, to become 𐤎 (*mem*).”*

[Let me just add here that “*mem*” is actually **MOM** today as you will soon see.]

NU OF NINHURSAG SECRET Y AND V

The Greek symbol V now called “**nu**” is the scientific symbol for **magnetism** (as just mentioned). This is an incredibly important distinction, as magnetism is the basis of *all usable energy* within the physical world. 100% of all energy is delivered by the sun (neutrinos) and 100% of it is inert and unusable the way it arrives. The “element” that causes the attraction/repulsion connection between these energies of - and + that allow mankind to use the energy would be in any language and any culture, referred to as god. And this is at the bottom of why V doesn’t just stand for *energy* in general terms, it stands the **MAGIC** that turns 100% of all inert energy into *usable* electricity which is *only* electro-**magnetic**. Here is the title **Nu**:

Wiki: *Nu*;

“*Nu /nju:/ (uppercase N lowercase ν , also transcribed Ny; modern Greek: $N\iota$ [ni] Ni), is the 13th letter of the Greek alphabet. It is derived from the ancient **Phoenician** alphabet **nun** Phoenician *nun.svg*. Its Latin equivalent is N, though the lowercase resembles the Roman lowercase *v*.”*

Under the Wiki definition of **nu** above, you will see it really stands for “**Ni**” (as in the goddess **Ninhursag**, which is just another name for **Wawwu**). But in ancient **Phoenicia/Sumerian**, where the “Greeks” derived **nu** from, is actually the word “**nun**” which stands for *snake*. One of the snake symbols from Phoenician times was 𐤎 , just as the Greek Nu “transcribes” to as *Ny* today, and where the funny upside-down **h** (μ) came from (just inversed). The modern Latin letter U was derived directly from the 𐤎 , which was reversed and used for the letter M (as in **Mu**) by **modern** Greeks with the same symbol μ , the symbol for **WATER**. The letter U was depicted by **early** Greeks and later by the Etruscans as the letter **Y** and later as the letter **V**. While the letter V didn’t look like V does today in more ancient times, it DID look like the letter Y, whose

Decoding The Hive

creation of gravity, light, time and the god particle

pronunciation was “V”. And that letter just so happens to be the MUCH later Phoenician’s symbol for the god of all gods, Wawwu (you will hear much more about as we go):

proto-Sinaitic 1900 BC			Phoenician 1050 BC			Hebrew			Greek 800-600 BC			Etruscan		Latin	
symbol	word	means	symbol	name	means	symbol	name	means	early classic	modern	name	symbol	early	modern	
𐤀	/w/ wawwu		𐤁	/v/ waw		ו			Ϝ ϝ	/w/ digamma	Ϝ	Ϝ			
						𐤂			Ϟ ϟ	/f/ phi	Ϟ	Ϟ	Ϟ	F f	
𐤃	/m/ mayim	water	𐤄	/m/ mem	water	מ			Ϡ ϡ	/ps/ psi	Ϡ	Ϡ			
𐤅	/n/ nahas	snake	𐤆	/n/ nun	fish?	נ			Ϣ ϣ	/m/ mu	Ϣ	Ϣ	Ϣ	M m	
𐤇	/q/ qoppa		𐤈	/q/ qoph	monkey	ק			Ϥ ϥ	/n/ nu	Ϥ	Ϥ	Ϥ	N n	
𐤉	/sh/ shin		𐤊	/sh/ shin	tooth?	ש			Ϧ ϧ	/q/ qoppa	Ϧ	Ϧ	Ϧ	Q q	
𐤋	/t/ tawwu	cross	𐤌	/t/ taw	mark?	ת			Ϩ ϩ	/s/ sigma	Ϩ	Ϩ	Ϩ	S s	
									ϫ Ϭ	/t/ tau	ϫ	ϫ	ϫ	T t	
									ϭ Ϯ	/w/ u pson	ϭ	ϭ	ϭ	U u	
									ϯ ϰ	/ps/ psi	ϯ	ϯ	ϯ	V v	
									ϱ ϲ	/o/ omega	ϱ	ϱ	ϱ	U u	

And in fact, the letter V itself within the Latin alphabet, not connected to scientific symbols in any way, reverberates the **exact same trail** as just shown you through ancient literary archeology:

Wiki: V;

“The letter V comes from the Semitic letter Waw [Wawwu], as do the modern letters F, U, W, and Y.”

But V stands for more than just energy, it specifically stands for **magnetic energy**. And magnetism is specifically - (negative) in electromagnetic energy-speak. Because the magnet is full of energy that is merely turned off at the moment when it is not actively doing something with that power. Thus, the - literally means power that is not yet on. + simply stands for the connector of that energy. The terms positive and negative were put in place to boost men’s personal moral, and to marginalize women. The **electron** as just shown in the previous chapters is a magnetic (power) boson. A multidimensional particle that is able to suspend the force of gravity. As mentioned, this stands for the White Queen in Hermetic teachings and will have everything to do with the god particle later. The White Queen is representative of all females on the planet, where they secretly carry more power than men do. They are the sole vehicle for the invader races to supplant this evolution, and therefore are the single-most targeted and morally-destroyed beings alive to keep them under easy control as brood mares for alien hybrids. While the female GOD is the highest of all deities, the female HUMAN is the lowest in all terms within this patriarchal reality. In terms of worship (piety) however, she is the living representative of the **Trinity**. The symbols given to her honor in science is overwhelming. Let’s continue.

ELECTRONS (-)

Decoding The Hive

creation of gravity, light, time and the god particle

In science, the **electron** (-) (which is the fundamental word for electricity), is “**null**” or “**negative**”. In ancient Sumerian pictograph (archeologists like to call “**Phoenician**” because otherwise the dates don’t make sense to them while trying to fit all of history into 6000 years to jibe with the holy babble) the **snake** was the symbol for “**nun**”, which was a horizontal line that was slightly wavy (𐎗). All references to the **female** energy in science is always the same symbol (-). **Nun** is the name of **females** in service to god in the Catholic church. **Nun** also means **null**. Nuns aren’t presented as giving birth, so therefore they are **null**. (Secretly they do, as they are factually harem girls for the priesthood but that is a rather large story for another day.)

proto-Sinaitic 1900 BC			Phoenician 1050 BC			Hebrew			Greek 800-600 BC			Etruscan		Latin		
symbol	𐎗	word	means	symbol	𐎗	name	means	𐎗	early	classic	modern	𐎗	name	symbol	early	modern
𐎗	/m/	mayim	water	𐎗	/m/	mem	water	𐎗	𐎗	𐎗	𐎗	/m/	mu	𐎗	𐎗	M m
𐎗	/n/	naḥas	snake	𐎗	/n/	nun	fish?	𐎗	𐎗	𐎗	𐎗	/n/	nu	𐎗	𐎗	N n

Now, ask yourself why in the hell would science use a symbol for electrons (-) and the V for electricity (Greek NV) that both came from the Sumerian name for **snake**. A language that died out 10,000 years *before* electricity was even invented. The answer to that should be obvious to you by now. Snakes invaded earth. Snakes had electricity. And snakes made the alphabets. All of them.

Over the many thousands of hours I have invested in the **S@t@in Cϕphzr**, it has become painfully clear that symbols were switched and changed *very* deliberately by the Sumerians in order to keep someone from actually piecing this all together as you are about to see now. I had to consult with Council *numerous* times on this subject, just to make sure that how (for an example) the upside-down **h** (μ) might secretly stand for the letter **V** in today’s mainstream use, but actually stood for “magnetic” **electricity** yet shown today as the letter M or others, and it wasn’t all just a figment of my imagination. But the **patterns** of use of the symbols down through history as carrying certain phonetic linguistic articulations that referred to “this god” or “that god” were *absolutely* undeniable.

Today what linguistic archeologists assume certain symbols ultimately meant back in pre-Egyptian times is so fractured and confused, that almost no one has been willing to try to break the codes for what the ancient, **ancient** Sumerian pictographs really meant. And I am talking about symbols that predate cuneiform script by many thousands of years, not the ages listed by archeologists.

PICTOGRAPH TO CUNEIFORM





Cuneiform 𐎗𐎗 was the first alphabet that was used for **mainstream** applications by the Sumerians who had already begun transitioning into “**Phoenicians**” by that time. **Predating** that by at least 6000 years, ancient **Sumerian pictograph** 𐎗 was used for **commerce** only, and only by a handful of royal scribes. Virtually no one could read or understand pictographs, not even most rulers. They were **Hermetically sealed** from open use, just as occult teachings are today. They were used only by absolute royalty, only by the priests and only for buying, selling or

Decoding The Hive

creation of gravity, light, time and the god particle

trading things. Those things were mostly limited to livestock, grains and other supplies, and humans. Or should I say “people”, because that included their own human hybrids along with the Angelic Humans they were here to replace. Most of their symbols referred to GOD (themselves), livestock and slaves and sometimes bread or the ingredients to make bread. Sometimes the pictograph symbols simply stood for spells they had cast into application such as the first

crucifix  which does not seem to make sense to researchers now, so they go without any transliteration to today’s modern symbols. Often I see “translations” that are so far from what the symbol actually stood for and what is assumed today that it defies any level of logic at all, because that symbol did not refer to just one thing as is assumed, but sometimes hundreds of nuanced incantations. 100% of all of those ancient symbols were Command Signets, and as such, literally carried many meanings, depending on exactly what application they were being used in. If the symbol was being used to depict buying or selling female slaves, it would mean one thing, but if it involved what the female slaves were supposed to do, then it would revert back to the Command Signet that enforced that action. This might have to do with 100 different things at any one given time, making that symbol to modern archeologists more than just an enigma.

The most important signets to focus on are the symbols for Wawwu of today’s XYZ letters that connect directly to all bosons we are going to be covering here (which are the secret power of the god particle) and amazingly they link **directly** back to the major (primal) symbols of  and  and the symbol for Elohim , because within these are the links back and forth between all the symbols used for neutrinos and ions as well as the Higgs Boson. The E for Elohim rests in the spear of **Poseidon** that is wielded by **Wawwu**, and the Σ also rests in the line for her other symbol . Wawwu not only carries the **E** of **Elohim** (in every **w** of the name), but it also carries **SEVEN** Vs (each of which stand for the numerical value of 1, and also the “perfect number” of “god”) as well. The number 7 is factually the number 1 which we will discuss far more deeply later:

proto-Sinaitic 1900 BC			Phoenician 1050 BC			Hebrew			Greek 800-600 BC			Etruscan		Latin	
symbol	word	means	symbol	name	means	early classic	modern	name	symbol	early	modern	symbol	early	modern	
	/h/	he	→	/h/	he	ו →	→	E ε	/e/	e	psilon	→	→	E e	
	/sh/	shin	→	/sh/	shin	ש →	→	Σ σ ς	/s/	sigma	→	→	S s		
	/w/	wawwu	→	/w/	waw	ו →	→	Φ φ	/w/	digamma	→	→	F f		
						→	→	Ψ ψ	/ps/	psi					

What we are dealing with here is a cipher of *unthinkable* tedium and detail. What you need to know is that the letter **V IS A IS E IS D IS O IS Q** and many other letters when used in a certain pattern or combination, but **ONLY** when in reference to the **POWER** of “god”; electro-MAGNETIC energy, the only usable energy through conventional means. Meaning energy that interacts on a 3D level. Below magnetic energy is the realm of the aether, where energy lies in stasis, awaiting transition from static to electric. Trust me, you will know the difference between these energies like a particle physicist before we are through, at least on a 101 level.

V IS GOD

Decoding The Hive

creation of gravity, light, time and the god particle

In science, V is god. In Hermeticism V is god. In Masonry V is god. In Zionism V is god. In Christianity V is god. As well as in **every religion** on earth because it is the pattern printed out by ALL atomic particles in their primal, **electromagnetic** form which now stands for the Trinity. But even deeper yet than this, V is the pattern by which the organic Hexagram Scalar Science was hijacked, something I will be showing you more about as we go. V is the symbol of magnetic, regardless of what science might have to say about it, because it is the foundation of usable energy. But V has been delineated into many subcategories of course, from V volts (outflowing) to O ohms (resistance). And no matter WHAT symbol they use in our modern times, V will **always** stand for S. For **SALT**, because salt is what allows fake gods to even exist at all because **SALT is** electromagnetic energy.

*Salt is **THE** code word for **crystal** and crystal is the only connection to energy that exists within the 3rd dimensional world.*

While electromagnetic energy may be what scientists use to produce energetic results with within this dimension, static electricity does exist and you do have command of the use of that energy, but robots don't. The only way they can access that power is through your god mind casting the command. So, in very real terms, electromagnetic energy is their bread and butter, and static energy is their ultimate goal in gaining access to. Static electricity has been used utterly in secret since before you even arrived on this planet to create the reality around you and has been the quantum, or genesis of the deception of all deceptions. Every attack that has been brought to bear in the effort to replace humankind has come from static electricity, because that is the unseen realm where only the gods tread. I will be covering this at great lengths in order to make certain that you have no illusions as to how the enslavement of man came about so you have a decisive direction to take in exiting this **electronic** maze. Only a god can create a spark from nothing but thought. That spark is **static electricity**. All others can only deal with electromagnetic energy unless you give them your power to use that spark against you, which will be much more difficult once you know how the game is actually played.

Without the help of beings who were there in person while such ancient symbols such as the very first V (∇) were actually in use, and educated to understand what they really meant, it would have been impossible to break the code of the **S@t@in Cyphez** without a few lifetimes all strung together in order to eventually get there. I take the time to explain this to you, because if you presumed that I was just nailing hundreds of assumptions together in order to bring you this report, you would never see the value in learning the cipher. I am sure there are many modern-day letters I am still clueless regarding where they really came from and what they really mean, but the letter V isn't one of them, because it is the most important letter in existence. That's why it has had the *royal treatment* applied to its ciphered application in the sciences it has enjoyed until now. And why it will be the most complicated symbol to explain.

In order to **manifest** as something corporeal, the particles that make up that *thing* must be electromagnetic in order to bind together other "particles" to make up the many different types of things called "matter" within the context of life. Electro is male, magnetic is female. Electro is the *worker bee* of material existence, and magnetic is the *queen*. When it seems like I am being redundant throughout this explanation, I am. Deliberately. Because the hierarchy of how things work has been reversed, just like the letters in this text, which means that your subconscious will

Decoding The Hive

creation of gravity, light, time and the god particle

continually revert back to what you have been taught before as the building-blocks to process what I am saying now and that won't work. You first have to purge old understandings before you can drink from the cup of knowledge. If your cup is full, then there is nothing more I can put into it. 100% of what you have been taught before is that females are worthless idiots (hysterical needing hysterectomies), and males are smart, logical and productive. Men create the world and women just live in it. Seeing how many of them you can screw before settling down (and after) has become the number 1 pastime in America today for males from the age of 12 forward. All such attempts to degrade women have risen from the secrets I am sharing with you here, because if women knew how valuable they really were *as mothers*, not worker-drones, then the **Love Program** to destroy the fabric of human-connection would collapse overnight.

*(Many of the **Programs** set in place to divide humankind used by the **World Management Team Illuminati** will be revealed in the upcoming full volume on the **S@t@in Cϕphϑr**. Between the millions –you read the correctly- that have been put in place by this time, there are three –coincidence?- that are the most destructive. The **Recycle Program**, the **G.O.D. Program**, and the **Love Program**. The **Love Program** is among the most debilitating of all, as it fools humans into “looking for love in all the wrong places”, by teaching you that you must find someone else to be happy. As long as you continue to look to a mate, or your children or family and friends to be fulfilled, you are never going to come into your own authenticity. Authenticity is the single, or **ONE** ethic you must find in order to move into another paradigm. If you don't truly love yourself as who you are, then no being in all of the *cosmeias* will ever help you because love is the essence of living **as one** with the rest of creation. As long as you single out another being as the “one” who you will “really love”, and treat all others as something less, you simply do not understand what the Law of **ONE** actually means. To love all things as you love yourself means there is only one gradient of love that actually fulfills the single commandment of material existence within the Gaia Time Matrix. If you don't already love yourself equally as you love something or someone else, then action is your only solution. Change. Be **today** what you wish you had been yesterday and then be that from there on out. You can't begin to pay it forward tomorrow because there is no such thing as tomorrow, there is only right now.)*

“Magnetic positive” (+) stands for **Alpha** (which is a code word for **Delta**), and “magnetic negative” (-) stands for **Omega** (which is code word for **Omicron**). The two energies combined make up the **Trinity** or as referred to in particle-physics as the **Triplet state** which is represented as quantum particles literally *print out* the full geometric formation of the top-half *pyramid* of the hexagram called a *tetrahedron*. This is the oldest and most important symbol in all of creation and its physical shape is a V. *Every single scientific symbol* used to define the Triplet state in the image on the left below are *ultra “god letters”* within the **S@t@in Cϕphϑr** without one exception. Next to that is the most ancient pictograph known within history to denote a female - predating Egyptian hieroglyphics by 6,000 years (and possibly for many millions). It is the *one symbol* where *all* of today's literary, mathematic and scientific symbols originated from, across the board, and was chiseled into stone for a reason:

Decoding The Hive

creation of gravity, light, time and the god particle

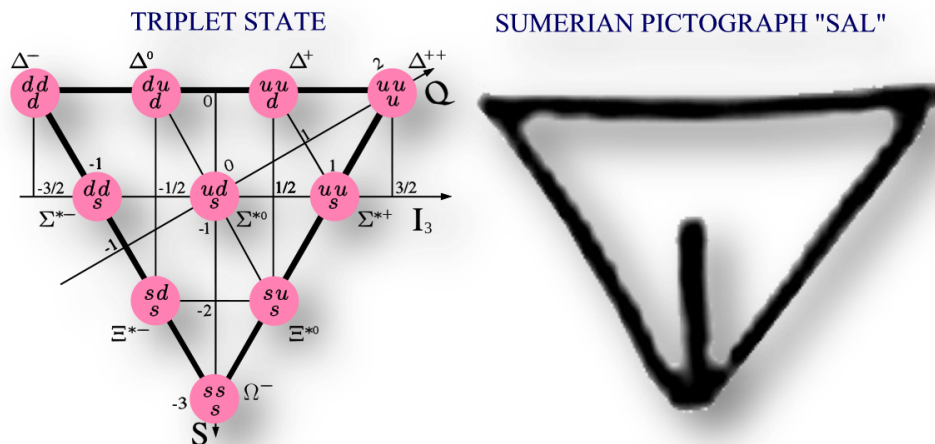

Wiki: **Triplet State**;

*“In quantum mechanics, a triplet is a quantum state of a system with a spin of 1, such that there are **three allowed values** of the spin component: -1 , 0 , and $+1$.*

*Almost all molecules encountered in daily life exist in a **singlet state [atoms]**, but molecular **oxygen** is an exception [as it is made up of multidimensional crystals]. At room temperature, O_2 exists in a triplet state, which can only undergo a chemical reaction by making the **forbidden transition** into a singlet state. This makes it **kinetically nonreactive** despite being thermodynamically a strong oxidant. Photochemical or thermal activation can bring it into the singlet state, which makes it kinetically as well as thermodynamically a strong oxidant.”*

*[The only particle that carries **oxygen** which “makes the forbidden transition” that defies the laws of science is **crystal** which is carried in **Deuterium** water. **Oxygen** is the **Omega/Omicron** which is an ion and can only be **activated** by an **Alpha** which is a **Lepton**.]*

Long before a male ever existed in all of time, there was female that gave life to man (her name was **Tiamat**). You can believe that nothing in creation compares to the power of mom. Only a **FEmale** can give a **FETus** life. And the smallest measurement in science just so happens to be **FEMtometre** (you will see why at the end of this report). No greater blessing has ever been bestowed to **mankind** that superseded the fruits of the **wombman**. In fact, celebrations were borne out of the expression of man to honor the gift of life she brings to creation called **FEstivals** that were in fact named after her. She is literally the **MEN-stration** (fabricating the **strata** that the genetics of man are formed on) “*period*” at the end of *every* sentence. The waters of her amniotic fluid have been equated to the waters of the sea since time began because there is a direct correlation between ocean water and amnio fluid. Mother earth uses the very same process to give birth to all life within this playing field as the female gives birth to man. **Water** was called **amniotic fluid** by the Sumerians, and believe it or not, water is still called **amneo** in

Decoding The Hive

creation of gravity, light, time and the god particle

current nomenclature within the intergalactic communities today. You will see time and again within science that the source of energy used by mankind always comes from **crystal** and always comes from **water**. Their most important particles are not named after SAL by accident. Salt comes from Deuterium from the bottom of the ocean. **SAL** is the **Holy Sea** of the **TRINITY**, the divine spirit that moves to magically bring forth life from thin air.

CHAPTER 23

THE NEUTRINO CΔΔΣ: ALPHA AND OMEGA



The above is the symbol for Jesus, the Alpha and the Omega. You might look that up. Just realize that Jesus was a name that Marduk Satain went under 2000 years ago. He is both Lucifer the light bringer and Jesus the martyr and this is his symbol, down beneath the ones all graffitied with other symbols such as A, Ω and P. Seems quite the coincidence now that the lord of earth would assume the actual, **physical** pattern of the sub-quantum Keylon Grid that all material existence is based on, doesn't it?

Decoding The Hive

creation of gravity, light, time and the god particle

In particle physics, the ONE positive particle (+) combined with the ONE “negative” particle (-) creates a THIRD element of the **strong force** represented by the **electron (E)** which physically makes a circle pattern (O) or sphere while in the form that can be seen with scanning microscopes. That shape is the **Omega Ω**. The lower-case symbol for Omega is **Omicron**.

Omicron ω (W as in water and *ω* as in *Wawwu*) is the **name** of the beings that made all the alphabets in existence on earth and the beings that now run all higher science known as the Marduk Satain Leviathan Drakonian “Seraphim Elohim” **OMICRON** Anunnaki. There are lots of names in the title because of the extensive provenance or genetic history to the being.

TRI VECA CODE

The positive (+) added to the negative magnetic (-) that powers the **strong force** in science is known as the **1+1=3 Tri Veca Code** principle in **Interdimensional Scalar Vibrational Science**. The red sphere below shows the creation of this 3rd element simply called the orbit that is considered the **spirit** that glues *matter* together. This spirit is hosted by Sentient beings inside of Krystalline bodies, known as family members of god source which are fractals of awareness that are serving as the worker bees within material creation inside of Time Matrices. When a nucleus or **group** of commands are gathered together by these Sentient beings we refer to as **aether**, it initiates the *triangulation of the zero-point* between the positive (antimatter) and magnetic (matter) energies which creates a TORUS field that surrounds that group that connects all the energies together which creates the sphere:

Decoding The Hive

creation of gravity, light, time and the god particle

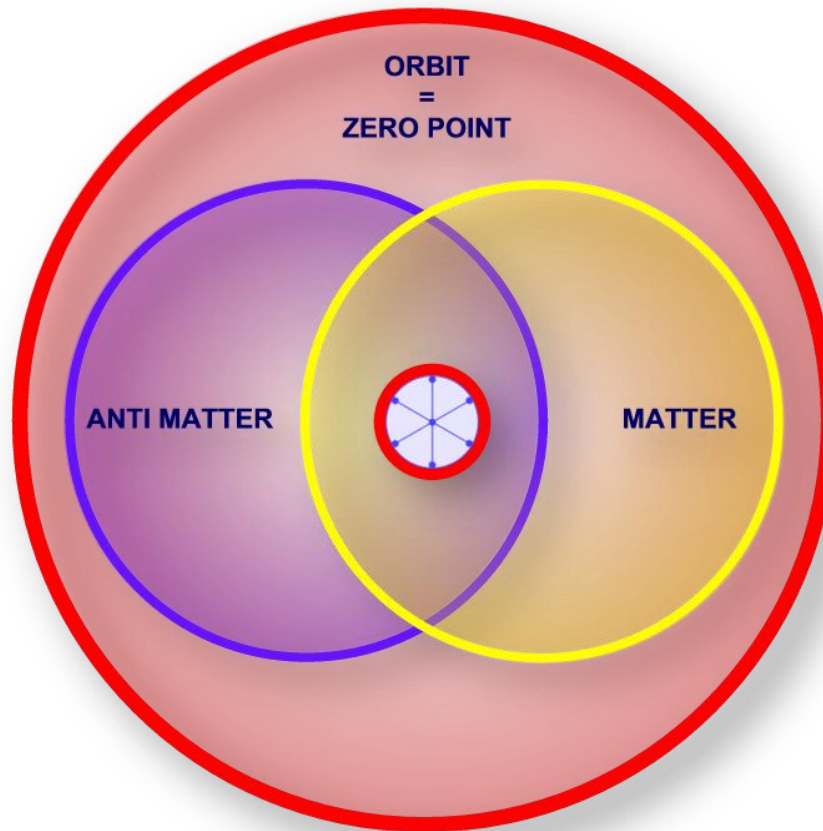

Tri Veca Code

DECODINGTHEHIVE.INFO

Particles that *carry* the force of magnetism from one nucleus of particles to the next are the carriers of life for all intents and purposes. *All three neutrino leptons fall under this incredibly significant and exclusive category.* And all three go under the code name of SAL (salt) as we will see.

NEUTRINO LEPTONS (+) AND IONS (-)

As mentioned, the particle literally named **Alpha** itself is the + side of atomic energy (the “electro” in electromagnetic) *carried by neutrinos called Leptons.* Then there is the – side of electromagnetic power carried in its independent form by **ions**. The **ion** is literally the particle that creates **Salt** (Sal) which is the secret to atomic and nuclear power:

Wiki: Ion;

“An ion (/ˈaɪən, -ɒn/) is an atom, or a molecule, in which the total number of electrons is not equal to the total number of protons, giving the atom or molecule a net positive or

Decoding The Hive

creation of gravity, light, time and the god particle

*negative electrical charge. An atom, or molecule, with a net positive charge is a cation. An atom, or molecule, with a net negative charge is an anion. **Because of their opposite electric charges, cations and anions attract each other and readily form ionic compounds, such as salts.***

*Ions can be created by chemical means, such as the dissolution of a **salt** into water, or by physical means, such as passing a direct current through a conducting solution, which will dissolve the anode via ionization.”*

I will need to point out that the **ion** is listed as “*carrying both positive and magnetic energy signatures*”, however, there is an overall “flavor” of each of these “particles”. Energy must be transported carrying at least a fraction of positive in order to deliver the magnetic charge (in order to remain in stasis). And like the “*overall positive (+) yet neutral*” neutron, the **ion** is also *considered neutral* in this state, even though it breaks down into a **cation** (+) and an **anion** (-) later (when it begins to enter into the 3rd dimensional spectrum through taking “material form” in an “atom”. But there is a massive difference between how much “positive” and how much “negative” energies are carried in this signature called an ion. As you can see below, not only is there vastly more **magnetic** charge to ions than there is positive, but the ion itself is the “mother” of **O oxygen** and the mother of **H hydrogen**. The ion when activated by a neutrino, produces massive amounts of oxygen and hydrogen (which is the secret to gravity). Notice that the **anion** (or the magnetic - side of the ion nucleus) is literally named after the Greek word for “**up**” to give you a clue as to where this is all going:

*Wiki: **Ion anions and cations;***

*An **anion** (-) (/ˈæn.aɪ.ən/ AN-eye-ən), from the Greek word ἄνω (ánō), meaning “**up**”, is an ion with more electrons [-] than protons [+], giving it a **net negative charge** (since electrons are negatively charged and protons are positively charged).*

*A **cation** (+) (/ˈkæt.aɪ.ən/ KAT-eye-ən), from the Greek word κάτω (káto), meaning “**down**” [code word for 3rd dimensional or “material”], is an ion with fewer electrons than protons, giving it a **positive charge**.*

*Cations and anions are measured by their ionic radius and they differ in relative size: “**Cations are small**, most of them less than 10–10 m (10–8 cm) in radius. But most **anions are large**, as is the most common Earth anion, **oxygen**. From this fact it is apparent that **most of the space of a crystal** is occupied by the **anion** and that the **cations** fit into the **spaces between them**.”*

*[Notice that when science is talking about **ions** which are the **SOURCE** of all electricity, they are talking about crystals.]*

Both **neutrinos** and **ions** flood into earth on a constant basis through the portal of the black sun, and until they connect with each other, they are *dormant* and carry what is called **zero spin** (which is also called “complete spin” as in O). Both **zero spin** and **whole spin** (not fractional

Decoding The Hive

creation of gravity, light, time and the god particle

spins) are the same, they are non-reactive, meaning they are sleeping. Once these two “sleep together” or interact, they transform into *atoms* now carrying balanced-portions of both sides of what is called *electromagnetic power*. This is 3rd **Dimensional** energy that is used to make *material existence*. All energy that we rely on in our everyday lives is **electromagnetic** which is literally called magic (magnets), because mankind does not know how particles can possibly know if they are supposed to *point north* or *point south* all by themselves. Though both neutrinos and ions are considered neutral, *neutrinos are known as positive particles* and *ions are known as negative (magnetic) particles*.

WAWWU AND SCIENTIFIC SIGNETS

Within the four different Signet Templates behind neutrinos unwittingly used by science to power the **Keylon Command Templates** for the **Electricity Program** are the symbols V, e, μ , and τ . Since the original SAL (Wawwu) carries forward all of the elements of these Signet symbols, we will be looking at all of them concurrently. The funny upside-down h as we have already talked about, the hidden h inside the ultra-royal titles such as Khane, Christ, Khan, etc. as mentioned stands for modern Greek “Mu”, which was taken from the Egyptian **Mem**, the word for **water**, which was their word for amnio fluid and sperm as well. All references to water were connected to the cycle of birth. **Mem** is linked back to **Wawwu** in so many ways it is impossible to overlook the direct correlations. **Mem** was the original cube symbol used by the Phoenicians (not shown below, but shown under Wikipedia under the heading of **Mu**) for **water** , the same symbol that the Egyptians used as well (which will have major significance once we get to the last pages of this volume). **Mem** was used prior to this in proto-Sinaitic times for **water** in the form of the **snake**, which later went under the **V** of **Wawwu**, which also went under the **Σ**, **S**, **ω** as well as the lightning bolt **⚡** from the original symbol for **Mem water**. As you can see below, **Tau** was symbolized by the **Y** in Etruscan times, which is the symbol for **Upsilon**, the symbol for **Wawwu** and the symbol for the **snake** and for **water**. Under **Tau** was also the **cross** (crucifix) **X** which is a **KEY** factor in what you are about to learn now regarding the **god particle**. At the bottom of the image below, you will see clearly that two “u”s stand for w which was also shown as a **Vesica Pisces** **⊖** which was the **Qoppa** symbol for **Q** which was later the exact same symbol for the original Wawwu **♀**, making every symbol below a **SIGNET** for **Wawwu**, and the **Psi** (Poseidon) trident **♁** not only stands universally as the symbol for **ocean water**, but makes Wawwu factually **Elohim** **☩**. Remember, “tails” don’t mean anything within the Cipher, as proven factually by the Greek “**Mu**” being symbolized officially with a tail on the wrong side of the u, h, y of Mu: **μ**:

Decoding The Hive

creation of gravity, light, time and the god particle

proto-Sinaitic 1900 BC			Phoenician 1050 BC			Hebrew			Greek 800-600 BC			Etruscan		Latin	
symbol	name	means	symbol	name	means	symbol	name	means	early classic	modern	name	symbol	early	modern	
𐤀	/w/	wawwu	𐤁	/v/	waw	ו			Ϝ ϝ	Ϝ ϝ	/w/	digamma	Ϟ ϟ	F f	
𐤂	/m/	mayim water	𐤃	/m/	mem water	מ			Ϟ ϟ	Ϟ ϟ	/m/	mu	Ϡ ϡ	M m	
𐤄	/n/	nahas snake	𐤅	/n/	nun fish?	נ			Ϡ ϡ	Ϡ ϡ	/n/	nu	Ϣ ϣ	N n	
𐤆	/q/	qoppa	𐤇	/q/	qoph monkey	ק			ϣ ϣ	ϣ ϣ	/q/	qoppa	Ϥ ϥ	Q q	
𐤈	/sh/	shin	𐤉	/sh/	shin tooth?	ש			Ϥ ϥ	Ϥ ϥ	/s/	sigma	Ϧ ϧ	S s	
𐤊	/t/	tawwu cross	𐤋	/t/	taw mark?	ת			ϧ Ϩ	ϧ Ϩ	/t/	tau	ϩ Ϫ	T t	
									Ϩ ϩ	Ϩ ϩ	/u/	u psilon	ϫ Ϭ	U u	
									ϩ Ϫ	ϩ Ϫ	/ps/	psi	ϭ Ϯ	V v	
									Ϫ ϫ	Ϫ ϫ	/o/	omega	ϯ ϰ	W w	

The symbol for water in **Hermetic Alchemy** is ∇, the exact same original Signet for Wawwu’s oldest Keylon Template not even shown in the most comprehensive ancient symbols list the segments above were taken from, which was **SAL** ∇. Today, the direct, official symbol for a **water** photon in modern science is γ, the same symbol used in Mμ and the same symbol used across u, m, n and f which all lead back **directly** to every symbol used for Wawwu. **N is M is W is V** which are all factually **E**. In Ancient Greek, **Mu** was spelled out using both **μ** and **ν**. In Modern Greek, the letter M is printed out using a **V**. Every one of these symbols secretly stand for water which secretly stand for SAL(T) (crystal), as you are about to see right now as I post again the description of **Mu** so you don’t have to go back and hunt it down:

Wiki: **Mu (letter)** "μ;

“Mu (uppercase **M**, lowercase **μ**; Ancient Greek **μδ** [mȳ:], Modern Greek **μ** or **μν** [mi]) is the 12th letter of the Greek alphabet. Mu was derived from the Egyptian hieroglyphic symbol for **water** (𐀀), which had been simplified by the Phoenicians and named after their word for **water**, to become 𐤁 (**mem**).”

OMEGA ELECTRONS

Electrons such as **Electron Neutrino Leptons** carry *negative* - energy which is code word for magnetic or incoming (meaning **Omega/Omicron**). These are the particles that spin around the nucleus of other *different types* of particles (atoms) and *binds them all together*. Electrons are so powerfully *repulsed* away from the nucleus of an atom, yet also so powerfully *attracted* to the core that the core particles don’t just fly off into space or hit someone in the eye, and generates the power of what is called the **strong force** as already mentioned, or *atomic force* explained in the “1+1=3” Tri Veca image above. The *electron* literally spins **pointing north** because it is so directly *magnetic*. In an **Alpha particle** that is made up of two pairs of particles that are **perfectly balanced** of electrons and protons (which just so happen to be anti-gravitic) that neither of them spin which is called **zero spin**, which is synonymous with **Triplet state** in

Decoding The Hive

creation of gravity, light, time and the god particle

science. Yet both are measured to have energy. And at the same time, the magnetic forces holding them together yet not touching each other is known of *as* atomic (nuclear) power.

Opposing forces inside the nucleus of an atomic (atoms) particle causes a pulsation which dictates its spin. Depending on the type of atom, these fuzzy shapes that science is able to see under a scanning microscope can look like a perfect sphere, or differing oblong shapes which tells them which is which. An **atom**, or a *fully functioning 3rd dimensional particle* has a **half spin** or some other *fractional* form of cloud it makes that *is not a perfect sphere*. This is because the core of that particle or **grouping** of types of frequencies inside is *out of balance*, causing its shell/orbit to go out-of-round to some degree. With 2 protons plus 1 neutron or any other imbalanced numbering, disfiguring of the perfect shell will happen. **One** proton (+ energy) plus **one** neutron (- energy) group will produce an absolute round cloud or orbit with a spin-pattern of **zero** or **1 full number**, meaning it will be a perfect circle which means that it is not an **atom**, it is a **boson** (keep this term in mind, or better yet write it down).

Simplifying the electron particle and the proton's trajectory inside the sphere, each one pulses through **magnetic moments**, which is the transition point between the upper-half of the sphere making its complete event horizon journey and then the bottom-half making its counter-rotational journey. The magnetic moment (the fission/fusion reaction) is the middle transition between these two, and the top and bottom particles maintain this *pulsation dance* as long as the particles inside remain the same. The **heartbeat** inside the cloud of an **atom** takes a waveform of course, and looks something like this:

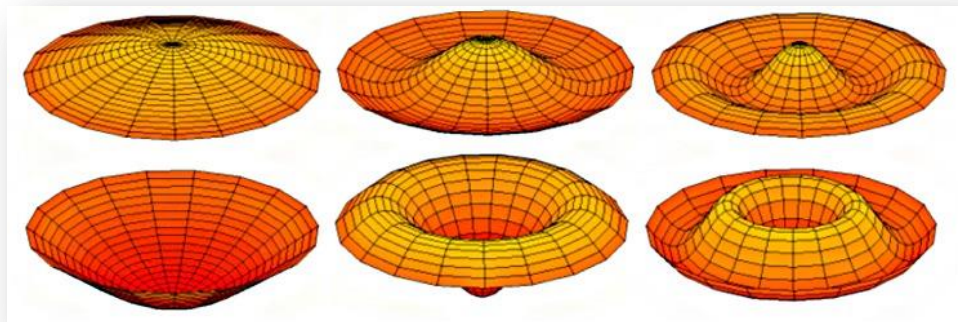

Out-of-balance particle-groupings create patterns to the heartbeat as shown above, which is a **fractional-spin** rate such as $\frac{1}{2}$ spin, or $\frac{2}{3}$ rd spin, etc. A **perfect spin** of zero (or 1-spin which can be either + or -) creates a ball or perfect sphere which is then called the *very rare* **Triplet state** ∇ , which is just one of the two halves of a full **atom**. Keep in mind, this Triplet state is only designated to **multidimensional** sub-atomic particles, not to atoms. They are **pre-atomic**, which means they are **not** being affected by the **Anunnaki Particle**: \blacktriangledown which just so happens to be exactly identical to the Triplet state scientific symbol; ∇ as the multidimensional force that is pre-atomic (neither one of which I made up, but came directly from scientific papers. I am merely putting a name on the symbol). Particle groupings that have a perfect sphere are elementary groups called **bosons** (sometimes **photons**, sometimes **gluons**, but always called **bosons**) which can play a role in atomic formation (**atomic** always means **fermion** which always

Decoding The Hive

creation of gravity, light, time and the god particle

means **atom** which always means **3-D**), or they can rest in static shape all by themselves. They are effectively the **guides** of the particle-world. To make this easier to understand, just think of it like this (unless you really need to differentiate each exact type of element for scientific reasons):

- **Atoms** (3-D, **fractional-spin**) are Leptons, Fermions, Electrons, Hadrons, Protons, Neutrons, Quarks ☸
- **Bosons** (aetheric, **zero or whole-spin**) are Gauge Bosons, Photons, Gluons ▼

INSIDE AN ATOM

What this really means is that **atoms** (top row) are affected by or *held together* by the **strong force** created by the **boson** which acts like **electrons** in general cases, binding them all together like strings wrapped around 3 acorns:

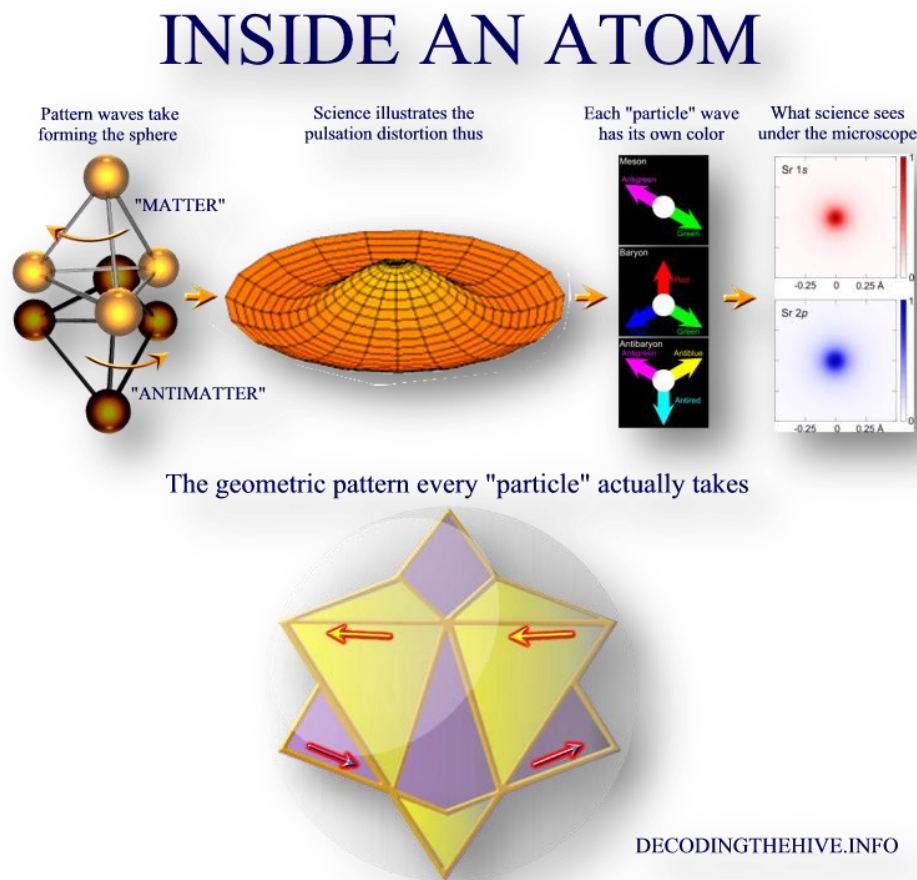

Bosons can also group together without the wild-eyed electron, as they are considered carrying the force within themselves. They play a role in the creation of all atoms, but they work differently, in that they break the laws of physics regarding gravitation and material existence

Decoding The Hive

creation of gravity, light, time and the god particle

(because they readily phase in and out of the visible spectrum and are able to share the same point in space). And while I am simplifying this to the extreme, this is the general idea of the two types of wave forces involved. Gauge bosons (zero-spin) carry a **weak force**, and gluons (atoms with fractional-spin) carry a stronger force. Photons (also zero-spin) carry the **electromagnetic force** (bi-directional) according to science which is **3500 times as powerful** as a mere **atom**. But **all bosons** are dealt with on a **color-basis** and are known as **photons**, regardless of what their technical names are. All boson particles and all atoms *are* in reality photons, but certain colors (frequency waves) have more powerful roles to play. When photons are referred to as **plasma**, that means they carry 100% of **the force**, and science is dealing with water in this case. Of course they don't openly mention that part, but that's where they "find" photons.

When it comes down to where electromagnetic energy originates, science looks to all the players under the heading **boson**, and they point their finger at the **photon**. Yet other names they give this title to will sound like other particles such as the **Alpha particle** and the **Higgs Boson**. Bosons **make up** atoms, but atoms are made up of only **little pieces** of the bosons inside each one and require *the string* of the electron to hold themselves together (why String Theory and M Theory seems to be the ruling theories at this time where Quantum science is trying to explain particle physics on an aetheric level for the first time since the secret Initiate teachings of Hermes). Bosons *independently* carry the strong force (without the help of an electron *string*) and also are magnetically charged from the outset, even though they are not holding a material form (you'll see what they do in a moment). And since electro-**magnetic** is **the** force that comes into **material form** in the form of an **atom**, that is **the** force that is the biggest player when it comes to granting titles to the gods.

What you can **see** called matter is **entirely electro-magnetic** energy. What you **can't see** are the wave forces that hold the individual electric wave and the magnetic wave while they are separated, because they only bring both waves together when **combined** to *come into* your viewing spectrum. When they are separate, they do not **pulse**, because they have yet to activate one another. They only pulse once you are supposed to see or hear or taste a certain thing. Until then, they remain part of both this dimension, **and** all other dimensions, as every pixel within this playing field is shared by all other dimensions within this 15 Level Time Matrix. When they are not flashing on in this dimension, they are serving the other dimensions and through pulsing or flashing on and off here for a tiny fraction of a second, this allows them to flash next in the *10th dimension*, and next in the *4th dimension*, etc., allowing them time to flash again in your visible dimension let's say *5 pulses later* to maintain your designated *flashline sequence protocol*.

ALPHA MEANS DARK MATTER

The power inside of the two protons and two electrons inside an **Alpha** particle (+) are static and not active, yet at the same time are *carrying* opposing forces to each other. By all accounts these core energies *should be pushing away from each other*, then pulling each other close in a frenetic dance if those energies are measurable. Yet they sit together as if long-lost-friends anyway. Their pairing defies physics, in that there are no electrons spinning around them holding them inside like the nucleus of an atom. Science explains that the strong force of *other* atoms somehow

Decoding The Hive

creation of gravity, light, time and the god particle

pushes these particles together to form this bond (as if being squeezed between two fat ladies). Then through the mystery of passing through air, two of the little proton particles (positive + **Alpha** energy) sneaks out and becomes free through a *push off* from the *back side* of the nucleus (in other words, they have no idea why it leaves, it just does). This particle would be considered a +1 spin under the **Triple State** ▾, meaning it is an **Alpha antimatter** or dark matter **in stasis** wave force.

Once a **proton** becomes free from the stasis found in the elemental particles, then that proton is able to become active, or interact within what we think of as real or a material part of our lives. Until then it is simply not part of our reality, therefore we dismiss it. It is in this quantum form that energy is introduced into our *electromagnetic* world. Science calls this **dark matter**, and science also calls **space** dark matter. In truth, what you have is energy that is delivered to you below the frequencies that science has the capacity to see, so they call this dark, but they also know it exists, so they call it matter. Neither is correct. What is invisible to this dimension is meant to remain invisible, because these are the building blocks of all creation that if man had access to, would be potentially damaging far beyond anything that mankind could imagine. The *dark forces* (called this because they rely on that dark matter to power their agenda) actively deal with **dark matter** at **CERN** and many other particle accelerators around the world in order to continue to advance the manipulation of your **flashline sequence** to keep you from being prepared for the Stellar Activation Cycle peak that is now immediately at hand. By speeding up your **time**, they are able to keep you occupied just with trying to stay alive so you will not be able to make the time to get to information like this. Dark matter has the energy of **700 times** what is allowed to be within the manifest world and can only be accessed or exacerbated to produce more than regular electromagnetic energy by damaging the crystals themselves through what they call a nuclear event. Damaging the seed crystals this way is strictly forbidden under the **Emerald Covenant**.

HOW V MEANS DELTA + ALPHA + TRINITY

The V in *Neutrino Lepton Electron Ve*, *Muon Vμ* and *Tau Vτ* is the universal symbol of the Trinity Δ as discussed. It is also the universal symbol for atomic particles themselves: , as it is the first tetrahedron (top or **manifest** triangle) of the full hexagram. Below that triangle the ▾ **Anunnaki Particle** literally was used to intercept the organic development of the hexagram, replacing one operating science with another. It is also the **in-your-face** symbol of the pyramid on the back of your dollars which is the symbol of your capture as covered in-depth in this report in the chapter THE HISTORY OF THE PENTAGRAM. And it is also the symbol of the wolf of ANUbis, the **gods** of ANU now spelled backward in DOG. In **Greek symbols**, the CAPITAL letter **D (Delta) prints this symbol: Δ**. This symbol is now **inverted** in science. The Delta which stands for the power of A-An of the Anunnaki is now: ▲, and the Nabla ▾ stands for the **ΔMEGA**. In advanced mathematics these symbols represent **Lattice Theory** which I will mention more about at the end of this chapter. Effectively this theory is attempting to *fix* modern math by making the symbols **universal eliminators**. What I just said is mankind's attempt to throw the baby out with the bath, and still have the baby in its crib. It is meant to be confusing, because the conjecture is obviously designed to confuse and obfuscate at the same time by

Decoding The Hive

creation of gravity, light, time and the god particle

introducing symbols that carry unique, omnipotent parameters prior to addressing the equation. Once you have more of an idea of how the Anunnaki Particle works, then you will be able to see why these are the symbols that have been chosen (in cloaked form) to represent this brave attempt by geniuses to make sense out of numerical symbols that do not work, were designed not to work, but appear as if they absolutely would work.

Just as the **D** in dog hides in the form of **G**, **V** hides in the form of **Delta** (the Red King) under the further cipher under Mu μ (which is the *dipole moment* - and + of electromagnetic fission/fusion reaction), then further under Pi π (the counterfeit Scalar Vibrational Science of Metatron) and then even deeper under the **E** of **Electricity** which secretly stands for (Tau τ) Trinity which is shown to you as zero **O** but actually CALLED **Salt**.

It is hidden, then hidden again, then hidden deeper, then buried under **13** feet of concrete. We'll need a jackhammer to get down to the actual truth, so let's get back to what subatomic particles *do* in order to explain what is really going on. In order to understand why **Lattice Theory** is using these precise two (one) geometric symbols in order to fix mathematics, you must first understand the descriptions of subatomic particles (that carry these hidden symbols) to begin to compartmentalize the aetheric, mystical actions of these two characters. Because believe it or not, they do not act like just symbols on the page, they act like they are alive and they know what they're doing in order to correct a foundational problem with fractional multiplication. And no, I do not mean using the symbols logically repairs the cracks in the system either. Just like photons that flash in and out of dimensions while being observed under microscopes, the Nabla and Delta function like quantum computing where their computational results comes from more than this one dimension. Look that up if you are having a hard time believing that computational science is literally asking spirits for answers, not *crunching numbers*. Religion claims there is an aetheric "holy spirit", science claims there is a holy spirit, and mathematics claims there is a holy spirit. Bet you didn't hear about that in 8th grade. Its *functioning* symbol is literally a tetrahedron.

FINDING THE GOD PARTICLE

When science *splits an atom*, it isn't splitting zero-spin particles like Higgs Boson particles or plasma (photons), they are *releasing* a **Higgs Boson particle** that will not have an electron holding in its core like atoms have:

Wiki: Nuclear Fusion;

*"In nuclear physics, nuclear fusion is a reaction in which two or more **atomic nuclei** [atoms] come close enough to form one or more different atomic nuclei and subatomic particles (**neutrons** or **protons** [3rd dimensional particles]). Fusion reactions create the **light** [as in **illuminated** which is **cipher-synonymous** with **anti-gravity**] elements [photons at the base of Hydrogen for example, which is a **Gauge Boson from the Higgs Boson family with either + or - "whole spin"**; either - to form the top half of the hexagram, or + which forms the bottom part or antimatter part of the hexagram that is standing or "kinetic" energy in stasis] that power the stars [playing fields] and produce*

Decoding The Hive

creation of gravity, light, time and the god particle

*virtually all elements in a process called nucleosynthesis. For example, in the fusion of two hydrogen nuclei [Deuterium] to form helium, 0.7% of the mass is carried away from the system in the form of **kinetic energy** [“sleeping” or “stasis”] of an **alpha particle** [which is one of the family of **bosons**] or other forms of energy [such as the **Higgs Boson** most often researched], such as electromagnetic radiation [remember, “radiation” means “radio-wave” as in invisible].”*

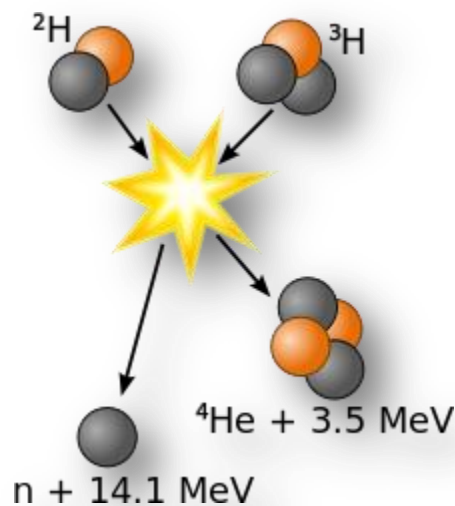

Wiki: **Alpha particle**;

*“Alpha particles consist of two protons and two neutrons bound together into a particle identical to a **helium** [the positive side of **Deuterium water**] nucleus [+]. Alpha particles, like helium nuclei, have a **net spin of zero.**” [▽ STASIS DARK MATTER Alpha +]*

Wiki: **Triple-alpha process**;

*“The triple-alpha process is a set of nuclear fusion reactions by which three helium-4 nuclei (alpha particles) are transformed into carbon [heavy crystals]. The final reaction product lies in a $0+$ state (**0 spin** and positive parity).” [▽ STASIS DARK MATTER Alpha/Alpha/Alpha +]*

Wiki: **Higgs boson**;

*“In the Standard Model, the Higgs particle is a boson with **no spin, electric charge, or colour charge.**” [▽△ STASIS ANDROGENOUS MULTIDIMENSIONAL Omega/Omicron -]*

Now look at what *spin* has to do with particles:

Decoding The Hive

creation of gravity, light, time and the god particle

Wiki: *Spin (physics)*;

“In quantum mechanics and particle physics, spin is an intrinsic form of angular momentum carried by elementary particles, composite particles (hadrons), and atomic nuclei.

When combined with the spin-statistics theorem, the spin of **electrons** [3^{rd} dimensional energy as in **mass** or **material** who’s nucleus is **held together** by an **electron**] results in the Pauli exclusion principle, which in turn underlies the periodic table of chemical elements”:

Standard Model of Elementary Particles

		three generations of matter (fermions)						
		I	II	III				
mass		$\approx 2.4 \text{ MeV}/c^2$	$\approx 1.275 \text{ GeV}/c^2$	$\approx 172.44 \text{ GeV}/c^2$	0		$\approx 125.09 \text{ GeV}/c^2$	
charge		$2/3$	$2/3$	$2/3$	0		0	
spin		$1/2$	$1/2$	$1/2$	1		0	
		u up	c charm	t top	g gluon		H Higgs	
	QUARKS	d down	s strange	b bottom	γ photon			SCALAR BOSONS
		$\approx 0.511 \text{ MeV}/c^2$	$\approx 105.67 \text{ MeV}/c^2$	$\approx 1.7768 \text{ GeV}/c^2$	$\approx 91.19 \text{ GeV}/c^2$			
		-1	-1	-1	0			
		$1/2$	$1/2$	$1/2$	1			
		e electron	μ muon	τ tau	Z Z boson			GAUGE BOSONS
	LEPTONS	$< 2.2 \text{ eV}/c^2$	$< 1.7 \text{ MeV}/c^2$	$< 15.5 \text{ MeV}/c^2$	$\approx 80.39 \text{ GeV}/c^2$			
		0	0	0	± 1			
		$1/2$	$1/2$	$1/2$	1			
		ν_e electron neutrino	ν_μ muon neutrino	ν_τ tau neutrino	W W boson			

(Note: in the table above there are **Leptons** and **Quarks** (**green** and **purple**) on the left that all have $1/2$ spin or other fractional variants.

On the right are **Bosons** and **Photons** (**orange**) which each have either zero spin or one full spin ∇ which work as the “particle that turn on the energy of the **Leptons** and **Quarks**, which set their patterns within what is called **atomic** energy \otimes . This refers to its nucleus being surrounded by a **negative** electron that creates

Decoding The Hive

creation of gravity, light, time and the god particle

*the orbit or **event horizon** of the particle cluster. These are the **carriers** of command traveling through the spacetime fabric.*

*On the top right is the **Higgs Boson** which has absolutely **no spin** or **electric charge** of any kind $\nabla\Delta$ yet holds both + and – inside, both in **multidimensional** form. This is the **phantom** secret **X particle** that turns atoms into electromagnetic matter for an instant in the miracle of flashing on and off.*

*The **Higgs Boson** is made up of 2 protons and 2 neutrons, a totally balanced number, which are both **Fermions** \otimes (not shown in the chart above, but are what make up **Leptons** and **Quarks which are atoms, not multidimensional energy**). These core energies are **Fermions** which are like **Gauge Bosons** in that they cannot take up the same space as each other and are considered matter (or visible in this 3rd dimension), but are not yet flashing.*



*However, the **Higgs Boson** $\nabla\Delta$ while made up of **Leptons** \otimes and **Quarks** \otimes has **totally** zero spin and is not the same thing as a **Gauge Boson** ∇ , because it **can** take up the exact same space as each other, even though it carries atomic qualities, which means it is absolutely **multidimensional energy** in both + and – energies at the same time which is why science considers this particle strictly an enigma. And obviously, so does mathematics. It is both material AND multidimensional at the same time or, **androgynous**, just like a photon. But the photon is never actually present while conducting atomic tests until the atom has been annihilated which produces that androgenous “thing” again called light. Since the **Higgs Boson** does interact with atomic force and carries both types of energy, whomever calling themselves “god” here on the planet, would absolutely connect themselves **with that particle**.*

*Inside **Gauge bosons** (regular bosons) and **Photons** are what is called the **Alpha particle** that carries inside its nucleus this zero-spin quantum which carries the positive (+) stasis energy ∇ . Splitting a **Boson** will reveal a **hidden Boson** referred to as the **Higgs Boson** $\nabla\Delta$ which is the **core** or element within that sets it totally separate from all other particles, and why CERN uses **zero-spin** elements in its search for interdimensional access. But they always use atomic **fermions** \otimes (atoms), which means they can make it **stand still** in order to split it open. They **are not** going to make a **Higgs Boson** (the **White Queen**) **stand still**, as it is fully multidimensional.*

*It is the **Red King Alpha particle (boson)** $\Delta\delta$ (+) that ejects from a nuclear explosion still in complete form, which carries **dark matter**. The **Alpha boson** is the antimatter **bottom** tetrahedron of the full hexagram \otimes and hence why science shows its **Triplet state** with the vector pointing **downward** ∇ . This is the half that brings in **dark energy** into material 3rd dimensional existence. The **Alpha Boson** (+) is used for **nuclear explosions** because it will give them access to **Dark Matter** energy in “expanded” (illegal) form.*

Decoding The Hive

creation of gravity, light, time and the god particle

The **White Queen Omega** Ω_0 (-) top half tetrahedron  is the **manifest** or visible side of the energy that can **only come from Higgs Bosons** that carry the **magic magnetic side of the equation**. Her **Triplet State** would factually be shown pointing both ways $\nabla \triangle$ if science were to properly designate its true state. Which they do not. **ONLY** together can the **Red King** (+ ∇) and **White Queen** (- \triangle) give birth to the full Merkaba field called the hexagram  which is **ONLY THEN** called an atom (**Adam**) . It is then the **EA** (Enki) particle **E-Eve+A-Adam**.

When science refers to an **atom** or **fermion** or **quark** or any particle with a **fractional-spin**, they are talking about the pattern being printed-out within quantum space of **both halves** of the hexagram pattern **after they have mated** .

The **Gluon** at the top of the **Gauge Bosons** vertical row above in **orange** is the **SHELL** that surrounds all the smaller particles on the left shown in the **purple** group called **Quarks**. It is the **proton** (+) holding the nucleus particles together within an **atom** and then that nucleus is held within the sphere created by an electron at the outside of the whole group (wrapping its “strings” around them as it were). It is **powered** by the **Neutrinos** at the bottom of the **green** section.

Here I post more from the section in Wikipedia of the **Spin physics** (from above) for an important reason, as it will show you in scientific terms that there are such things as **scalar particles** that hold specific positions “in the sky” as it were that **you will** want to know about. It also explains how these ultra-unique **zero spin** particles are connected to **gravity**. My notes are contained within the explanation in brackets []:

Wiki: *Spin (physics) Cont.;*

Fermions and Bosons

“Those particles with half-integer spins, such as $1/2$, $3/2$, $5/2$, are known as **fermions**, while those particles with integer spins, such as 0 , 1 , 2 , are known as **bosons**. The two families of particles obey different rules and broadly have different roles in the world around us. A key distinction between the two families is that **fermions** obey the Pauli exclusion principle; that is, there cannot be two identical **fermions** simultaneously having the same quantum numbers (meaning, roughly, having the same **position**, velocity and spin direction). In contrast, **bosons** obey the rules of Bose–Einstein statistics and have no such restriction, so they may “bunch together” even if in identical states. Also, composite particles can have spins different from their component particles. **For example, a helium atom in the ground state has spin 0 and behaves like a boson, even though the quarks and electrons which make it up are all fermions.**

This has profound consequences:

Decoding The Hive

creation of gravity, light, time and the god particle

*[Indeed, this means that **Gauge bosons** ∇ are being suspended as pure energy particles in **stasis** and **defying gravity** that are merely holding the **quadrant-vector** (scalar location) of one particular pixel that is awaiting command for its next mission. Once that message is delivered, the energy for its next **pulse** is **activated**, making it now **atomic** or **earthly** energy \otimes . Until it flashes, it is in perfect-spin and suspended outside of gravitational force. Once it flashes, that perfect balance is lost and then **gravity appears**. If the earth itself created gravity, this would be by **all accounts** a scientific, **physical** impossibility and nothing science could ever postulate would ever disprove this statement.]*

Fermions and Bosons Cont.:

*“Quarks and leptons (including **electrons** and **neutrinos**), which make up what is classically known as matter [3^{rd} dimensional particles], are all **fermions** with spin $1/2$ [now carrying the **tetrahedron pattern** or **top-half** of the **hexagram** pattern of the full Merkaba Hierophant]. The common idea that "matter takes up space" actually comes from the Pauli exclusion principle acting on these particles to prevent the **fermions** that make up matter from being in the same quantum state.*

[SPIN CODES:

- * **Spin 1** is the code word for **Gauge bosons** (usually simply called **boson**) **holding** both the **Y** and **Z** coordinates of a **location** that is **FIXED** in the sky in **one place** at that one precise moment*
- * **Zero-spin** is the code word for not being bound to any location yet (such as **ONLY** the **Higgs Boson**)*
- * **Fractional-spin** is the code word for holding a fixed position **AND** carrying a gravity-signature, indicating it is now an **atom** called a **fermion** which is a code word for **below the firmament**, or now part of **Tara-firma**. A fermion is a **FIRM** (matter) **ion**:*

- While particles are **fractionally spinning**, they are **FLASHING**, holding the shape of something, whether that be your desk, or air or any other thing. Their **sound** or **color** is moving from one quadrant vector to the next while on a mission to complete that full command. That's why **atoms** (which means matter) cannot hold the same state or **PLACE** at the same time with each other, but **bosons** (atoms that are not currently flashing and are spinning in perfect-resonance), can. That pixel they are delivering the message to **do this now** that is pulsing as the color of someone's eye this second will then be holding the color of someone's hair the next moment as the person **walks through** the spacetime fabric].*

Decoding The Hive

creation of gravity, light, time and the god particle

Fermions and Bosons Cont.:

“Elementary particles which are thought of as **carrying forces are all bosons with spin 1**. They **include** the **photon** [which is **always** code-word for WATER photons] which carries **the electromagnetic force, the gluon (strong force), and the W and Z bosons (weak force)** [W and Z bosons are scalar-vector coordinate particles that hold the **Y-Z** position of the pixels of the spacetime fabric. The **phantom boson** (Higgs Boson) will provide the hidden **X** coordinate once that pixel has been given its mission parameters which will then provide the **depth** of that image].

[Take special note of this following section, as bosons are not **just another particle**, but are specifically **holding the fabric of spacetime together** (in the words of science itself, so you don't have to just take my word for it) as just explained above, through **scalar-wave mapping** (which allows one to visibly see under microscope where boson particles are holding their positions, prepared to flash) which is achieved **mechanically** by triggering a laser which is simply vibrating at **the same harmonic frequency** as the W Z (YZ) Gauge bosons.]

Fermions and Bosons Cont.:

“The ability of bosons to **occupy the same quantum state** is used in the **laser**, which aligns many photons having the same quantum number (the same direction and frequency), superfluid liquid helium [Deuterium hydrogen] resulting from helium-4 atoms [Deuterium hydrogen] being bosons, and superconductivity where pairs of electrons (which individually are fermions) act as **single composite bosons** [which means that **Gauge bosons** act together with **Higgs Bosons**, all of which are **scalar-vector** particles that **triangulate** the position of energy-release of that single pixel].

“Elementary bosons with other spins (0, 2, 3 etc.) were not historically known to exist, although they have received considerable theoretical treatment and are well established within their respective mainstream theories. **In particular, theoreticians have proposed the graviton** (predicted to exist by some **quantum gravity** theories) with spin 2, and the **Higgs boson** (explaining electroweak symmetry breaking) with spin 0. Since 2013, the Higgs boson with spin 0 has been considered proven to exist. It is the first **scalar particle** (spin 0) known to exist in nature.”

[This is because there is no such thing as **gravity** until counter-rotational, **electromagnetic**, imbalanced-spin is placed within material manifestation. The spins created by the three bosons **together** create gravity and manifest that when they **flash** which is then considered **material**. A perfect **zero spin** is **antigravitic**, an **out-of-balance spin** (fermion atoms) is **not**. All particles with zero-spin or whole spin **do not follow** the Pauli exclusion

Decoding The Hive

creation of gravity, light, time and the god particle

*principle that identifies **3-D atoms** that carry **gravity**. The only particles that **cannot** hold the **same space** as another are **atoms** which are considered **mass** because they are out-of-balance and cannot achieve absolute harmonic resonance, meaning they are unable to achieve superfluid **anti-gravity**.*

*A group of particles that are able to achieve unlimited, free-movement through triangulation of their spins (as shown in the anti-gravity illustrations previously) are doing so **between** flashes, not **during** flashing. Once they flash, their zero-spin, perfect resonance is lost and their pattern goes out-of-round. Only while vibrating like a **washing-machine in shaky-spin-mode** -which is caused by the **release of their flash**- do the photons then radiate the **frequency** of a rock or a leaf, and will then **generate** and then **react to** the force of gravity to your observation. And **even then** while that rock is falling, nothing is actually moving downward other than **photons** creating the illusion of gravity.*

THE HOLY GHOST IS A STUN GUN

*The **rays of the sun** pulsating Anunnaki Particle ▼ flashline-sequence codes are why the perfect zero-spin carried by the Higgs Boson is lost. It is only at that moment of **projecting material reality** when the crystal is no longer able to hold its otherwise perfectly-balanced spin. Each flash or pulse of the sun fixed with this carrier wave mutation of the **Nabla tetrahedron** acts exactly like a **stun-gun** to the crystal's bodies carrying the mission parameters which spazzes-out the electronic frequency of the crystal for a tiny fraction of a second. The unseen-hand in science, in math and in religion literally does exist, and the symbol of the Nabla actually does carry with it this unaccountable and very real quality, that is why this symbol is **the symbol** mathematics uses in their equation string in Lattice Theory and it isn't some random other geometric symbol, because for a fraction of a second while applying this symbol to their equation, they are able to neutralize this otherwise constant affect so they can reach a "real" answer. You can rest-assured that **Lattice Theory** is used in the most advanced **Occult Hermetic teachings** for this very reason, giving **Initiates** the ability to generate more accurate results than university mathematicians.]*

Fermions and Bosons Cont.:

*"Theoretical and experimental studies have shown that the spin possessed by elementary particles cannot be explained by postulating that they are made up of even smaller particles rotating about a common center of mass analogous to a classical electron radius [as in "atom"]; as far as can be determined at present, these elementary particles **have no inner structure**. The spin of an elementary*

Decoding The Hive

creation of gravity, light, time and the god particle

particle is therefore seen as a truly intrinsic physical property, akin to the particle's electric charge and rest mass."

*[Which factually means that science cannot explain why elementary particles such as the Higgs Boson, Gauge bosons, and WATER photons do not obey the laws of gravity, because they continually choose to ignore the idea that gravity comes from mass -which does not exist until they assign a gravitational signature to the color of that flash-, it comes from the **command** behind the wave force.]*

DELTA SYMBOL ALPHA AND THE ΔMEGA: Δ = V

I mentioned at the outset of this section that the **Anunnaki Particle** of Nabla and Delta is both the Alpha and the Δmega, so I will mention this here before we break down the science of additional particles in order to give you the answer as to how this is true. I will cover this again later because it is easy to forget all these symbols and intensely-hidden meanings at the same time as covering *particle physics*. The Nabla is not used in everyday application for the masses, but science alone. The reason will become clear in a moment:

Wiki: Nabla;

*"The nabla is a triangular symbol like an inverted Greek delta: $\{\displaystyle \nabla\}$ ∇ or ∇ . The name comes, by reason of the symbol's shape, from the Hellenistic Greek word *νάβλα* for a **Phoenician harp**, and was suggested by the encyclopedist William Robertson Smith to Peter Guthrie Tait in correspondence."*

Just as **Pan's flute** made music that placed children into hypnotic trances, the **Phoenician harp** symbol is meant to do the same. The Phoenicians didn't just make the harp, they made the **Command Codes** behind the symbols of every single thing within their world as the images that would hold the scalar waves of their intent to hypnotize your evolution.

Since this is a confusing topic, and someone needs to explain the gobbledygook that advanced science and math has now managed to infuse into the minds of the intellectual hierarchy, I will touch on this here if for nothing more than the sake of explaining exactly what the Nabla-Delta Program actually is, as applied to this one topic.

As explained at the start of this report, math is broken. I don't mean that simple math is broken and that algebra is okay, or that geometry is the answer that rudimentary math refuses to consider, I mean that the mathematical symbols we use today are talismans that are designed not to work. They look proper on the surface, and they seem like they could resolve any complicated equation, but they can't. No matter what mathematicians ever do, they will never function past $1+1=2$ because there is no such thing as 1 and 1 being absolutes. That is because we are attempting to quantify ambiguous postulations as if there is such a thing as a 1 that is absolutely

Decoding The Hive

creation of gravity, light, time and the god particle

identical to another 1 somewhere else. There isn't, and as long as we act like there is, we will never see the answer.

BROKEN MATH

The entire concept that has been taught to mankind about what mathematics are has been a sham from the outset, where there are 9 numbers that are separated by a magic "number" that is zero, which allows the first 9 numbers to go on to become a trillion-trillion more quantum truths. This is not because there is no such thing as 5 apples that can be purchased along with 3 more apples, but because the number 3 is a talisman, **not** a number. So is every number before and after that. The apples are real. The numbers aren't. Attempting to make the apples into numbers is impossible for more than just a single trip to the market. After that, there are quantum differences that immediately become obvious that affect the outcome of the transaction. While I can say I have 5 apples, and that I want to sell them for \$1.23, there will never be a way that our numerical symbols will ever offer the system to actually quantify that sale because the apples each weigh a different amount. Plus some apples will have a worm inside, 2 were picked yesterday while 1 was picked last week, and the other two were grown using Bob's pond water while the previous three were raised on purified well water, making those 5 apples actually 3.97733445 apples with incalculable quantum values. Since our mathematics do not address these differences, nor the other thousand differences on top of that I am not mentioning, there is no way to make our platform work, no matter how absolutely simple it may look on its face. Because it was designed to fool from its very tenets.

And while it may look like I am just making all of this up, I'm not, otherwise there would be no such thing as **Lattice Theory** in science and in mathematics both, which is an attempt to correct the truck after it has already left the road and entered the enchanted forest.

What I mean by this, is through our naiveté, we assume that there is such a thing as a constant in a world where every single apple is a unique creation all of its own that actually has a mind that is both dependent and independent at the same time because apples are not computers, no matter how much we want to make them into one. All things are alive, which means that all things are at their very foundation, individuals. So mathematical science attempts to adjust the way numbers are used instead of going back to square one and setting up their own system that addresses the quantum fact that all things are alive and therefore, different as well as unpredictable. And once again, because there are millions of equations that have already been shown to sort of work to explain how to use numbers to represent precise results, it would be unthinkable to simply abandon the entire construct for the mess that it actually is. We keep trying to force the symbols to produce the expected results, not realizing that the numbers themselves are also alive and have been programmed to work differently than it appears on the surface that they should. And that's where the illusion takes over and we are led down the yellow brick road.

I am in no way attempting to get to the bottom of Vortex Math at this time, I am just preparing you to begin processing the concept that numbers were handed to mankind while they were babies, so the babies never even considered that they might be something other than what mom and dad said they were, as this goes against every instinct that we have to imagine that they

Decoding The Hive

creation of gravity, light, time and the god particle

would feed us rat poison instead of oatmeal. But this is exactly what has happened, and now that we are flying jets at Mach 5, it is impossible to even begin to think that all this technology had been a scam from the very beginning. Mankind will have to somehow deal with the level of deception that has led our civilization to this extremely ugly fork in the road that offers either the kingdom of gold on the right, or into the forest of the unknown wanderer on the left. The last thing we want now is to willingly take the left road when we can see the Emerald City from where we think we stand. But it has been the biggest deception of unspeakable magnitude anyone could ever dream up that has led us to this point we are facing now.

THE HUMAN PATSY

Society is not broken today because humans aren't decent people; it is broken because we were tricked into trading our hard-earned shillings for magic beans. Fables were never written to entertain humanity, they were written as disclosure that is required for them to continue the charade perpetrated on mankind. They were telling you right up front since the day you were born that people (aliens) are going to lie to you and you simply didn't get it. As I have explained, this is because there is a fundamental flaw in the operating platform of the Angelic Human Krystos blueprint that makes them gullible and targets from their very inception. While your DNA is able to rebuild itself back from a greas spot on the highway and do so into eternity if you should so decide, what it doesn't do is make you suspect of the world around you. All I can conclude is it was assumed at the outset that the gods being placed into those superman suits would be safe due to their unparalleled abilities to overcome adversity unlike anything that had gone before, allowing them more sensitivities than any successful evolution that had gone previous. What the Template did, was produce an entire race of innocent patsies.

The Angelic Human can be thought of as a bunny rabbit or a lamb. There is no guile in that genetic blueprint model. It was made to be loving, compassionate, sympathetic and kind. Just as you might want to imagine angels to be in real life, something we would call "pure love and light". But your captors weren't placed into manifestation as bunnies, they were literally wolves with pre-defined instincts given to them at birth that gave them guerilla warfare senses and response triggers that flood their neuroreceptors with fight or flight adrenaline at much lower thresholds than lambs were designed with. The overwhelming lie of Darwinian evolutionary construct has engrained into your basic patterns of thought processing to accept that apples are just apples and people are just people and there is no divine plan for anything. Everything around you is a crap-shoot from the outset and the best you can hope for is mercy when you stumble into a viper's nest. Or more exactly, for a miracle that will allow you to continue surviving in a world where there are such things as snakes that are genetically predisposed to biting first and asking questions later. The deception hasn't just been the big bang theory, but literally every magic tile on the floor you have ever stepped on since entering this arcade.

So now it comes to the point where you must return to school to be told that even your desk you are sitting in had been designed to confuse and mislead you to guide you to a predetermined destiny and that your pencils are really magic wands that write down things on the paper that aren't actually your own test answers, but programmed responses garnered through MK Ultra warfare. And just as your own response to this segment where you recoiled in disbelief to what I

Decoding The Hive

creation of gravity, light, time and the god particle

am saying, you have been programmed to not only be unable to arrive at the correct answers on your own, but the artificial brain that controls your thoughts has been stratified to reject reality when it is finally shown to you. And the more time you have been subject to the programming, the more difficult it will be for you to accept that somehow you have been surrounded by wolves in sheep's clothing without having been able to spot the deception. Because ego has been the only workable way for you to survive from 0 to 5 to start with. Letting go of that is exactly like stepping off of a cliff and expecting an invisible bridge to just appear below your feet that are already moving away from the mountain, when no one has ever reported something like that actually ever happening before. Faith.

FINDING THE FAITH OF A MUSTARD SEED

And what is faith at its most condensed form after you have spent a lifetime being entrained by your priest to take that leap or burn in hell forever if you don't, and when you do, you land in the arms of a pedophile in a backroom closet? But faith is one of those words that have been turned into a cymatic geometric talisman where when you think, speak or write that word, it has an affect that cannot be anticipated. And just like selective, romantic LOVE, or, basic MATH, you continue to return to that concept over and over again, only to keep getting your hand bitten. And yet, you do it anyway but you don't know why. The word faith itself isn't the culprit; it is the spell behind what it conjures in your mind and your subconscious when you use it. Faith was supposed to mean belief in yourself as god, the creator of all things, not belief in someone else creating your experience for you. Right now you are likely applying the top tiers of your intellect, wading through a mental inquisition that repeatedly assaults your senses for the most benevolent of aspiration; to learn something that will actually help you understand how to change the game. That's what faith was supposed to mean since its inception, not psychological fraud. You must believe in yourself that you will jump through whatever hoops placed in front of you in order to get to the goal of freedom, regardless of how difficult that might seem. Otherwise the game is set to repeat and there is no such thing as an off switch.

LATTICE HYDRODYNAMIC THEORY MATHEMATICS

With that now in your perspective, I will briefly touch on Lattice Theory to explain the Anunnaki Particle, the baseline-quantum conundrum of communication, scientific definition and mathematic pandemonium. Just the fact alone that Lattice Theory that is applied in high-speed fractional trading that has been shown as a high-tech theft scheme is also called hydrodynamic, referring to water, should give you some idea of exactly what is actually happening here, and it's not mathematics, its Hermetic Mathemagics.

In this brave postulation, scientific mathematicians are attempting to force numbers to bark instead of meow, as if their complicated quagmire of theorems will overcome living equations, just like Pi is designed to simplify the debate with the drunken pig of rocket science. Intellectuals (geniuses) like to think of their power of reason to be the magic particle that makes them supercomputers that can quantify things with numbers. They have been correct 96% of the time

Decoding The Hive

creation of gravity, light, time and the god particle

throughout their lives compared to a public that at best manages 50, so basic reason tells them that they can rely on their neuropathways to shine the light on the dark trails facing mankind. And in that “light”, it also stands to reason that Sir Isaac Newton’s law of gravitation merely puts into perspective how it is that celestial bodies seem to do what they do. It is all very rudimentary and logical. Once that has been put to bed, the geniuses will all be able to retire to the smoking room for a fine brandy and a lively conversation, uncluttered with the hysterics of the women and children dissolving their exchange with chirps and squawks that paralyze their lofty minds.

But Newton’s theory wasn’t a “best guess” at what was actually happening, it was a Program that rolls out into every civilization exactly at the time mankind begins to break the veils down between him and the stars. It is a scheduled curriculum that is pranced out like a dancing pony at exactly the right time each cycle of the play to convince waking humanity that there is no such thing as Sentience outside of their own haphazard, accidental existence of man and man alone. Dogs don’t have it, cows don’t have it, just accidental man has Sentience because the green slime where everything came from didn’t flop over to the left when it burst out of nothingness and into divine creation from nowhere, so just humans were magically gifted with the ability to reason. And on the surface, it really does look like planets do act like subatomic particles, apples fall from trees and earth never actually slams head-on into the sun, so he must be right. There is a constant to the celestial dance, and there is a constant to the gravitational *thing*, so everyone goes back to work and acts like they are ready now to get on with the more important things like making cars that run on fuel that will eventually kill every man, woman and child on the planet.

So the real peril is that by accepting this very carefully constructed lie is that mankind truly believes the planet they are standing on is a ball of dirt made up of nothing other than primordial goo that solidified long enough for a monkey to learn how to handle combustion, not realizing this is a symbiotic relationship between the planet and the life forces living on it, where if they work together they will all be able to experience corporeal existence. Together. Not as one premium species that has the self-given right to subjugate all other forms below him that are unable to defend themselves. So we toss garbage into the water, fill the air with smoke so thick it looks like dusk 12 hours a day and enslave all our companions to the pleasure of our own will, and all by our own divine provenance. It is no longer a symbiosis, but a rule of law system where if you have the power to conquer, then it is your god-given-right to do so in every way that you might dictate. And when that self-serving convention breaks down, where does the pandemonium actually come from? Ask Pan, the being who brought you that word to start with.

THE VACUOUS TRUTH ABOUT NUMBERS

The big picture to the lie of Pi is not your misunderstanding about what creates gravity so much as it is the vehicle by which you drive away from taking responsibility for your own actions and living in harmony with all of life around you. No civilization that functions by proxy to their own ends regardless of the means will ever, ever move forward. And keeping you at this level is exactly what Pan has had in mind for you since he arrived. I don’t mean to vilify Pan, I only mean to clarify that you are not “making this up as you go”; you are being led deliberately to embrace these understandings of old in order to keep you from ever standing in your own authenticity as the creator beings who designed this operating platform literally at the dawn of

Decoding The Hive

creation of gravity, light, time and the god particle

time. And Lattice Theory is attempting to right the ship now, using the same wheel that steered him into the swamp. In trying to understand Lattice Theory, it is best to show you the premise by which the theory was based. Notice that it is not using numbers to explain the correction to the math problem, it is using real-word situations that math is simply unable to ever address (because math is a lie the way it is being applied today). But more than this, there are people who know good and well math is a lie, and they use it against you at all times through ciphered symbols you have absolutely no idea of what they actually do. When numbers break down, they do so due to what is called a **Vacuous Truth**:

Wiki: Vacuous truth;

*“In mathematics and logic, a **vacuous truth** is a statement that asserts that all members of the empty set have a certain property. For example, the statement "all cell phones in the room are turned off" will be true whenever there are no cell phones in the room. In this case, the statement "all cell phones in the room are turned on" would also be vacuously true, as would the conjunction of the two: "all cell phones in the room are turned on and turned off".*

More formally, a relatively well-defined usage refers to a conditional statement with a false antecedent. One example of such a statement is "if Uluru is in France, then the Eiffel Tower is in Bolivia". Such statements are considered vacuous because the fact that the antecedent is false prevents using the statement to infer anything about the truth value of the consequent. They are true because a material conditional is defined to be true when the antecedent is false (regardless of whether the conclusion is true).

In pure mathematics, vacuously true statements are not generally of interest by themselves, but they frequently arise as the base case of proofs by mathematical induction. This notion has relevance in pure mathematics, as well as in any other field which uses classical logic.

Outside of mathematics, statements which can be characterized informally as vacuously true can be misleading. Such statements make reasonable assertions about qualified objects which do not actually exist. For example, a child might tell his or her parent "I ate every vegetable on my plate", when there were no vegetables on the child's plate to begin with.”

So you can see that numbers when attempting to arrive at an absolute result, simply do not work because they don't take into consideration the chaos theory that states there are unlimited nuances to every equation that will have a direct impact on the result of the formula that cannot be addressed with numbers. Which means that numbers themselves are not what they appear to be at all, but a carnival of illusion. We use terms such as “*I covered my bases from A to Z!*” not realizing that A to Z is merely the first few words to a paragraph, or the front step of your house when you are planning your adventure. By assuming that 1 through 9 is “complete” just by adding a zero that has absolutely no value of *any* kind is to imagine that there could never possibly be a snake at the bottom of your camping bag or a scorpion in the bottom of your shoe.

Decoding The Hive

creation of gravity, light, time and the god particle

And the reason all of today's math and science doesn't actually work is because there are no such things as numbers that can quantify Sentient beings.

Imagine you are given an assignment by your master (owner), to quantify your value as a slave so he can remunerate you for the 20 years that he has worked you on his plantation now that he has seen the light and realized the error of his ways. Pen in hand, you address your paper before you to write down how much he has actually taken from you. You will immediately write down "20 years at 200 hours per month, times \$13 per hour = x". Then you will stare at that paper and remember how hard it was to watch your sister go with that new owner when you were both 12, and how many walks in the woods you never got to take and suddenly you realize that life cannot be quantified into numbers any more than you can put a price on that wooden horse your father carved for you just before he was killed in the war. Science and math are now realizing that all things work this way, not just the value of human life, but every single apple in that cart. So when they try to crunch the numbers, there are all these things that never yield a solid result because math itself is a lie. There are constants in corporeal life such as "yes" or "no" that we can look to in order to make a determination. But there will always be the "maybe", and there is no such thing as a "maybe" number and no such thing as a "maybe" letter. At least not that you have heard of before. That number is 3. It is the three points of the Nabla which we will look at next.

Letters are actually numbers. Numbers are actually Command Signets, each one with their own set of spells that have been coded directly into that symbol to *do this when that*. It is based on the actual electronic vibration of standing scalar waves that genetically alter the way in which the spacetime fabric functions that is absolutely invisible to your naked eye. When these vibrations are intercepted by the crystals within the spacetime fabric, it distorts the message of the mission that each crystal is set to relay to the next pixel. And just like someone repeatedly interjecting certain words into the air (trying to be funny or just an ass hole) while you are trying to explain something, it confuses you so your communication becomes distorted and either makes no sense, or the message literally comes out of your mouth with a message that is backwards from what you had intended to say. The number 3 does this every single time it is spoken or printed, or thought in your mind, and it does so in every single version of 3 that exists within our parlance. So E, M, W and 3 will do the exact same thing to the aether around you, and so will anything with 3 points to it, such as the tetrahedron. And since the letter V has the same 3 points, it will do the same. And when inverted, it will have a counter affect to the aether when strung between qualifying symbols before or after it, which fixes it with an "UP" or "DOWN" quality.

The way the Anunnaki Particle works has been integrated into your life all around you that you have been utterly unaware of all along. It was used symbolically in the slaughtering of tens of thousands of Krystians in the killing fields of the Colosseum in Rome called the *Damnatio ad bestias*, or the damning to death by being eaten alive by lions and when gladiators would fight and then just prior to beheading the losing warrior, the victor (Victor) would look up to the Emperor and to the crowd for a thumb's up or a thumb's down. The knuckles of the onlookers were two points of the tetrahedron and the thumb was either up (suspending the otherwise universal dictate of recycle –death–), or it was down, meaning the Nabla was in place and to return to the dust of the earth the victim. Is this a stretch to connect these symbolisms now? NO.

Decoding The Hive

creation of gravity, light, time and the god particle

The Nabla is a functioning, cymatic geometric Command Code that is literally heard by the aether and acted upon because it is using the actual language by which the aether functions.

There are many, many symbols that are fully functioning aether command patterns that have never been placed between your alphabet of A and Z or between your numerals of 1 and 9 that simply are not accounted for at all today. Rather than give you the actual tools to compute true results within a material world made up of unique, Sentient beings, you are handed **Nabla** and **Delta** as the hidden-hand decision-makers which are ciphered in the V, W, M, E (and others), and the number 3, along with all multiples of that such as the 6 and the 9. In the case of Lattice Theory, the tetrahedron is called a **supremum** that removes the variables out of the preceding or following number of the equation, but interact between themselves through an agreement about what they will and will not consider. And what does that sound like? And what does the word supremum sound like? And what does the Anunnaki Particle do to the Scalar Vibrational Science of the Gaia operating system when it hijacks the resulting hologram and then turns upside down? It is a dictatorial numeral that changes when and only when it decides.

LATTICE ORDER

I do not paste this cut into this report intending for you to read and understand this nonsense, I paste it here to show you some example of how human scientists goes about attempting to right the sinking ship of math to show you not only how far your captors are willing to go to confuse your intellectual leaders, but how the symbols are not from your alphabet, and they are not from your numerical system, but are a cipher code used by the Hermetic Initiates to add layers to the already unthinkable construct of illusion already in place for humans to figure out, while they use them secretly to generate values in order to steal in broad daylight. I will highlight the sections that are of actual import and pick this up afterward:

*Wiki: **Lattice (order)**;*

*“A lattice is an abstract structure studied in the mathematical subdisciplines of order theory and abstract algebra. It consists of a partially ordered set in which every two elements have a unique **supremum** (also called a least upper bound or join) and a unique infimum (also called a greatest lower bound or meet). An example is given by the natural numbers, partially ordered by divisibility, for which the unique supremum is the least common multiple and the unique infimum is the greatest common divisor.*

*Lattices can also be characterized as algebraic structures satisfying certain axiomatic identities. Since the two definitions are equivalent, lattice theory draws on both order theory and universal algebra. Semilattices include lattices, which in turn include Heyting and Boolean algebras. These "lattice-like" structures all admit **order-theoretic** as well as algebraic descriptions. If (L, \leq) is a partially ordered set (poset), and $S \subseteq L$ is an arbitrary subset, then an element $u \in L$ is said to be an upper bound of S if $s \leq u$ for each $s \in S$. A set may have many upper bounds, or none at all. An upper bound u of S is said to be its least upper bound, or join, or supremum, if $u \leq x$ for each upper bound x of S . A set*

Decoding The Hive

creation of gravity, light, time and the god particle

need not have a least upper bound, but it cannot have more than one. Dually, $l \in L$ is said to be a lower bound of S if $l \leq s$ for each $s \in S$. A lower bound l of S is said to be its greatest lower bound, or meet, or infimum, if $x \leq l$ for each lower bound x of S . A set may have many lower bounds, or none at all, but can have at most one greatest lower bound.

The entire platform or tenet of this system uses Nabla and Delta symbols, plus it uses them placed also on their sides, which literally cancels out the previous portion or the equation, or it multiplies the result, as that Initiate chooses. It uses **tritons** rather than Es that phase into S or X and in the image below (that would not paste in as text). Here you will see the symbol for Nabla as used in its normal V position, as well as inverted. Not using the V typed by your keyboard, but oversized Vs that somehow like the triton spear above are supposed to do “other things”. There is absolutely NO REASON to apply symbols “sort of like” normal grapheme symbols of the same shapes unless they were also using normal letters at the same time in order to distinguish a concise difference. But they aren’t. Throughout science they use similar symbols constantly because *that’s how this equation system works* they are told. In truth, these are precise scientific symbols made specifically for Indigo psychological entrainment, not for the masses. Indigos are here with elevated IQs not so they can become scholars and academic leaders, but so they can translate the lies you are being fed into explanations that allow you to understand where the deception has been coming from. Every SINGLE symbol used in this theory are the highest god-letters in the entire alphabet. Is that a coincidence? I absolutely assure you it is not:

A partially ordered set is a bounded lattice if and only if every finite set of elements (including the empty set) has a join and a meet. For every element x of a poset it is trivially true (it is a vacuous truth) that $\forall a \in \emptyset : x \leq a$ and $\forall a \in \emptyset : a \leq x$, and therefore every element of a poset is both an upper bound and a lower bound of the empty set. This implies that the join of an empty set is the least element $\bigvee \emptyset = 0$, and the meet of the empty set is the greatest element $\bigwedge \emptyset = 1$. This is consistent with the associativity and commutativity of meet and join: the join of a union of finite sets is equal to the join of the joins of the sets, and dually, the meet of a union of finite sets is equal to the meet of the meets of the sets, i.e., for finite subsets A and B of a poset L ,

The Nabla and Delta symbols used here in **Lattice Theory** as the **ALL** are applied in both the rightside-up and the upside-down positions immediately before the \square or lowercase a, which are the same symbols, just transliterated. The f is the ancient symbol for Wawwu, the material goddess of all material gods. When the upside down A (same symbol with the variant of the electromagnetic - sign added) precedes the lowercase letter a, as you can see above, also precedes the Trident € laying on its side. This is the position of death, and it is factually the symbol for Wawwu as well. The lowercase letter a stands for Wawwu “trapped”, or now earth-bound (all of which will be covered in tedium in a coming volume of the **S@t@in Cϕphɛr**). So the upside down A, preceding lowercase a, followed by the “dead” Trident € would unequivocally stand for “NO” to all portions of the equations that came before this absolute command. The oversized V or the inverted oversized V, while preceding the parameters of Wawwu’s role held within the scalar waves of that symbol (as well as the lowercase a), will carry with it **the absolute power of all usable energy within creation and all the elemental powers outside of creation at the same time**. There are no such things as symbols that would have more power than these three when combined to command the aether I am aware of. And

Decoding The Hive

creation of gravity, light, time and the god particle

somehow, *coincidentally*, **Lattice Hydrodynamic Theory Mathematics** just so happens to apply them repeatedly back-to-back, all the way through their entire tenet. A theory based on **water** dynamics.

While it is *called* the Nabla in math, its physical symbol in scientific use is the **letter V as in Neutrino Leptons Ve**. The V version of the Anunnaki Particle, Nabla ▼, when applied to mathematical equations, **applies** the effect of the material **Metatron distortion** of the matter before them, and the A version of the Anunnaki Particle ▲ temporarily **suspends** that distorted quality, which is why the same symbol used either right-side UP or upside DOWN functions, literally, to provide the results they are attempting to achieve. While the entire Lattice Theory is meant to “fix” math (for the merchant who is involved in high-speed fractional stock-market computation), it is at the same time fully equipped to implement the illusion of ADAM at the same time in order to allow that accountant to skim off high volumes of money without anyone (other than another Initiate of the Craft) to be able to identify the slight-of-hand. Think for a second: why it is the most advanced **Hermetic Alchemists** (magicians) of all time were also the most advanced accountants of all time? We will get into more of that in a moment. The symbols they use factually function on a plane humans have never been allowed to know anything about.

Since science does not use a symbol for the **Higgs Boson god particle**, it stands only to reason that one symbol that would stand for the power of the Anunnaki would also include the **opposite** of the **Triplet state** ▼ at the same time. The Triplet state symbol is only used to depict the *material* **perfect-spin** particles, not both **material** and **aetheric**. As we will cover in a minute, the **singlet** particle of **oxygen** in **Deuterium** is a very special element not yet spoken of in the boson descriptions just covered. It goes under the scientific designation of **O** and the subcategory of **1Δg** (which literally is like saying “The ONE, the ALPHA, GOD” in ancient, original terms). When the Anunnaki Particle first arrives to do its damage (as you will see later), it shows up in this state (Nabla): ▼, but then immediately turns into this state (Delta): ▲, the **A** of **AN** and the **A** of the **Anunnaki** (which are two entities. One is a guy and the other is a group, but they both effectively represent the whole). It is the ALPHA of the ALPHA particle that infuses Oxygen into the **ion** (by the Alpha neutrino particle strike) that causes it to **breathe the breath of life**. It is at this point where the Nabla **becomes** the Delta of oxygen carrying the symbol of **O** which is obviously the **Omega**. This is exactly why the Delta symbol now is **upside-down to the Triplet state** symbol used in science. I will be covering the full Anunnaki Particle later, for now you can keep this in mind as we work up to exactly what the full scope of that particle really means to our Chimera existence.

CHAPTER 24

THE NEUTRINO CADΣ: HIGGS BOSON



In an absolutely *stunning* coincidence, the long-awaited Higgs Boson god particle was finally located on the very *anniversary* day that America “*won its independence*”! And discovered by the same group actively changing the timelines to prevent mankind from waking up by the deadline just a few months later at the beginning of the Stellar Activation Cycle of 12/21/12, the first chance at independence mankind has had in hundreds of thousands of years. What are the odds of such a major breakthrough in understanding where “matter” comes from coinciding with the date of the biggest deception in American history? *Astonishing*. Better order more fireworks to celebrate quick so the lambs can be dazzled more than **ever** before! You may want to look up the phrase *bread and circus*.

As a refresher, CERN splits **atoms**, not quantum particles when looking to *find* a Higgs Boson. Higgs Bosons exist inside the **command** within the **frequency** code of every mission, be it a bird’s flight pattern or an apple falling to the ground. It is written in **light**, or pure photonic-wave

Decoding The Hive

creation of gravity, light, time and the god particle

structure which was created by a **sound** frequency. That sound that is *hitting all the right notes* is carried by light and the light then passes along that message to every single pixel that will have anything to do with the mission. Once the message has been delivered to each pixel playing its own role, the Higgs boson *flashes off* and back into dormancy once again until reaching the next pixel or the beginning of the next command. Meaning that a *spinning atom* will *always* have a boson inside, ***otherwise the boson will not be visible within this dimension***, just like the hidden **Primal Keylon** below the millions of **Fire Letter** Templates surrounding you today. That's why you cannot split a Higgs Boson into *something else*, because the command IS god (and why the Higgs Boson is called the god particle), and can only be placed into creation by a member of the god family. Those are **people**, not particles:

Wiki: **Higgs Boson**;

*“The **Higgs boson** is an elementary particle in the Standard Model of particle physics. Unlike other known fields such as the electromagnetic field, it has a **non-zero** constant value in vacuum.*

*[**Non-zero** refers to its spin, which is constantly taking any direction it chooses. That is called a **fluid movement**, as it is not bound by any mission **moment** of flashing while it is supposed to be holding the form of **zero** within any “vacuum” experiment, because the scientists observing it are expecting it not to flash or do anything. And it is the code of the aether to support the expected result of the expectation of a god (which are Sentient beings, such as scientists). While there is no such thing as a vacuum, the scientist **thinks** there is because he has been lied to by his teachers, so that crystal wave-force functions within the parameters of the experiment. Quantum science has proven that the aether knows exactly what the scientist is thinking before he even thinks it, and has done so thousands or hundreds of thousands of times, making this a quantum science-fact.]*

Higgs Boson Cont.:

*“The presence of the field, now confirmed by experimental investigation, explains why some fundamental particles have mass [material existence] when, based on the **symmetries [geometric template patterns]** controlling their interactions, they should be **massless** [“mass” is a code word for **electromagnetic energy**].*

*In the Standard Model, the **Higgs particle** is a boson with **no spin, electric charge, or colour charge**. It is also very unstable, **decaying into other particles almost immediately** [NOTE ** **Pixel Position** section below]. It is a **quantum excitation** [it activates “mass” into existence] of one of the four components of the Higgs field. The latter constitutes a **scalar field** [NOTE * **Scalar Field** section below], with two neutral and two electrically charged components that form a complex doublet of the weak isospin SU(2) symmetry. The Higgs field is tachyonic, which does not refer to faster-than-light speeds, but means that **symmetry-breaking** through condensation of a particle must occur under certain conditions [it is changing from one **geometric pattern** to the next, depending on its next **stage** of the mission]. The Higgs field has a “Mexican hat” shaped potential with nonzero*

Decoding The Hive

creation of gravity, light, time and the god particle

strength everywhere (including otherwise empty space), which in its vacuum state breaks the weak isospin symmetry of the electroweak interaction. When this happens, three components of the Higgs field are "absorbed" by the SU(2) and U(1) gauge bosons (the "Higgs mechanism") to become the longitudinal [scalar vector] components of the now-massive W and Z bosons [scalar vectors] of the weak force [not-yet-within-material-manifestation-stage force]. The remaining electrically neutral component either manifests as a Higgs particle, or can couple separately to other particles known as fermions [atoms] (via Yukawa couplings), causing these to acquire mass [flash] as well."

*[*Scalar Field: The Higgs Boson carries a "scalar field" as shown above. This means simply that while Scalar Gauge bosons cannot share space with any other particle, a Higgs Boson can, and carries inherent scalar-mapping abilities to target precise quadrant-vectors. Scalar Gauge bosons also carry scalar-mapping abilities to hold the form of connected, invariant frames within spacetime, which means they are not able to share that space with other particles, as that pixel has already been vector-mapped and is awaiting the next flash command.]*

SCALAR FIELDS

This establishes the accepted fact that Higgs Bosons carry *scalar fields*; take note now exactly what this really means:

Wiki: *Scalar Field*;

"In mathematics and physics, a scalar field associates a scalar value [vector location] to every point in a space. The scalar may either be a mathematical number or a physical quantity. Scalar fields are required to be coordinate-independent, meaning that any two observers using the same units will agree on the value of the scalar field at the same absolute point in space (or spacetime) regardless of their respective points of origin. Examples used in physics include the temperature distribution throughout space, the pressure distribution in a fluid, and spin-zero quantum fields, such as the Higgs field."

*[** Pixel Position from Higgs Boson previous, and now to Scalar Field directly above: The particle "decays into" other particles, meaning that it becomes other particles that are doing different jobs, and will continue to make this transition between one geometric pattern and the next, depending on what color the next pixel is supposed to hold. While the Higgs Boson is in zero-spin form, it is free to move from one quadrant-vector pixel to the next within the fabric of spacetime that will need its mission parameters.*

In the Scalar Field explanation immediately above, it states that position observed will be at the "same absolute point in space" (or spacetime) regardless of their respective points of origin." This means that the Scalar Gauge bosons that are holding the spacetime vector of a certain pixel are moving from one pixel

Decoding The Hive

creation of gravity, light, time and the god particle

*to the next, along with the Higgs Boson, following the entire path of that mission together. Therefore those Scalar Gauge bosons being tracked to any one precise quadrant-vector seem to be moving. Because the **mission** or **song is moving**. But the pixel they are locating never moves. That “point in a space” is always that precise “point in a space”, but the bosons themselves never are. The **landing runway** never moves, only the flagmen change or the lights down both sides progressively flash, giving the illusion that something is traveling. Higgs Bosons are also called photons by science. Photons are light. When light moves, it does so **outside** of the parameters of gravitational force. This is the god particle: ▽△]*

The **Higgs Boson** is held within *all atoms and all photons* and functions both as a material thing or an invisible force, depending on its point in the mission and its location at the time never changes its function. Only the location of that one photon changes. Science can see both the light wave AND the pixels of the fabric, giving them the ability to time the distance between each pixel that the wave is traveling to. Each pixel within the spacetime fabric has an **identification number**, just like an **internet IP address**. This can be arrived at by counting *how many seconds* it would take a Y-Z Scalar Gauge Boson (photon) to go from *here to there*, telling them what *number* within that *quadrant* vector that pixel is located at. Of course time-craft relocation has been explained by many whistleblowers as repositioning itself within the spacetime fabric by entering **vector coordinates** that are identical to IP addresses, so this isn't news. But the fact that the boson is the locator for these spacetime vectors is, at least in my reeducation process:

Wiki: *Scalar boson;*

*“The only fundamental scalar boson in the Standard Model of particle physics is the **Higgs boson**, the existence of which was confirmed on 14 March 2013 at the Large Hadron Collider. Various known composite particles are **scalar bosons**, e.g. the alpha particle [+ energy within the Higgs Boson] and the **pion** [the **pion** is a **Pi Meson**, which is a **Lepton** within the **neutrino** family that carries the - **magnetic** energy within the Higgs Boson]. Scalar mesons have invariant parity under **Lorentz transformation**.”*

And here is what science understands about *scalar-vectoring* under the **Lorentz transformation**. Read carefully:

Wiki: *Lorentz transformation;*

*“In physics, the Lorentz transformation (or transformations) are **coordinate transformations** [between one pixel to the next] between two coordinate frames that move at constant velocity relative to each other.”*

*[Again, these “frames” never move, but the signature science is able to record within one frame then to the next carry the SIGNATURE of **that one** aether particle which is a **Krystal Seed Atom** within Interdimensional Scalar Vibrational Science parlance. Because the signature is the same, they assume the frame is also moving with the wave.]*

Decoding The Hive

creation of gravity, light, time and the god particle

Lorentz transformation Cont.:

*“The term "Lorentz transformations" only refers to transformations between **inertial frames**, usually in the context of special relativity.*

*[According to Wiki, “All **inertial frames** are in a state of constant, rectilinear motion with respect to one another; an accelerometer moving with any of them would detect **zero acceleration**.”, which tells you that the illusion of movement and their limitations due to that, within the minds of scientists, is suspended by the notion that all the pixels are **moving together** at the same velocity, therefore they act like they are fixed while they are observing the movement of photons between them. This is flatly not true. The ruling elite that governs science insists that the planet and all of space are moving at a constant, break-neck speed in order to implant into the public’s mind that their life is hurdling along at such an unthinkable speed, that it is impossible to ever understand the complexities of the higher atmosphere, which they call “space”. Such concepts make a person feel so incredibly small and insignificant that they are lucky just to be breathing, much less ever able to grasp the truth about their surroundings. Space is **not** moving. Earth is **not** moving. **Nor** is it spinning. Only photons move and what they carry is **sound and light only, not matter**. And the only place they are able to create the illusion of time and space is inside of a **Time Matrix (fabricated playing field)** which **does not move**, nor does your computer screen while you are watching Star Wars or any other program.]*

Lorentz transformation Cont.:

*In each **reference frame** [spacetime vector or “pixel”], an observer can use a local coordinate system (most exclusively Cartesian coordinates in this context) to measure lengths, and a clock to measure time intervals. An observer is a real or imaginary entity that can take measurements, say humans, or any other living organism—or even robots and computers. An event is something that happens at a point in space at an instant of time, or more formally a **point in spacetime**. **The transformations connect the space and time coordinates of an event as measured by an observer in each frame.**”*

Just to clarify this point a bit further, the **energy** between pixels continues to move, because the mission that is being processed by each wave never sits stationary. When the command to flash comes in to each pixel, the next pixel automatically gets the message of the color it is supposed to project next, and the pulse or flashline sequence given by the sun and moon dictate the tempo or rhythm of *pause* between each one, which means that the energy (which they *call* matter) *never stops moving*. So it seems like all the pixels are in constant expansion. As long as science continues to embrace such wild-eyed notions as the *universe eternally expanding*, they will never realize they are living inside of a hologram that exists on the pin-point of a needle, sharing that *same* pin-point with a trillion-trillion other worlds where distance or *space* is utterly nothing more than an illusion. That will restrict their experiments to material constructs which are nothing more than folly. The quantum at the core of the most fundamental particle in existence is the photon (which is a crystal, Sentient *wave* of thought alone) which is made up of energy, light

Decoding The Hive

creation of gravity, light, time and the god particle

and sound. Before they use the implied contextual substrate of “space” or “mass” ever again for their formulas, they need to first explain where they found that matter.

QUADRANT VECTORS

This demonstrates that the fabric of spacetime is known to science and that the pixels of that fabric are already **sequentially quadrant-vectorred**, meaning they are able to independently locate the Y-Z coordinates that carry that one unique signature, or *IP address*. The *event* mentioned above creates a signature frequency or color that is unique within all of time and space, meaning that the IP address of that one quadrant vector **for that split-second of time** is known and documented within the **Akashic Records** held in the **Silicate Matrix memory bank** made up entirely of *sentient silica-crystals*. If a time craft (typically called space crafts) wants to visit that precise location **at that precise time**, then entering that IP address will translocate the **awareness** of all the beings on that craft to that exact point both in space and in time. In other words, the craft doesn't ever *physically move*, only the **awareness** of the **Sentient beings** do. It is their **awareness** that **casts** the craft and all other *material* things into the visible spectrum once they *get there* and can **only** do this because the **recording** of that moment or event is held in the *silica-crystal* data banks that **only** members of the god family have access to replay.

*But even if they do travel to that spacetime vector (let's say in “1809”), they WILL NOT be reliving that exact timeline progression from that moment forward, because they didn't exist **within** that timeline that has already played out. They can **ONLY** create a brand-new timeline that they are now a part of from that second onward, which causes a split in timelines where the other one will always exist, and the new one will now be made up as that person continues to interact, creating trillions of new events that could take place at that precise quadrant-vector pixel which all become part of a new set of recordings in the Akashic Records. Every pixel within the fabric can have unlimited events and unlimited IP Addresses that will only differ by the event and its own unique **timeline**, not by the **location**.*

The only way a robot can *go there and see something* is if they travel there **in the presence** of a **Sentient being**. This is how time crafts operate, by translocation, not by burning rocket fuel that is unable to push off of anything in an atmosphere that has no *material content* to create friction. Even if there were such a thing as *motivation* (forward movement to project the craft), in *deep space* between planets (which does not and never has existed, sorry Captain Kirk), there would be no such thing as friction that would allow that craft to slow down or stop. All positioning within space (the upper atmosphere of earth) must be generated *inside* the craft alone, which means that awareness is the only thing that can *go there*. This is why most true time crafts (that operate higher than mountain-tops) **are** Sentient beings so the **artificial intelligence** beings inside will be able to see something once they get there.

There are places where the Star Trek type of *outer space* does exist, but they are not part of this playing field. These are constructs in the 3.5 dimension within the bands or *veils* between the 3 and 4th dimensions. Those are totally constructed artificial playing fields that have been created by invader races that are within what are called the **astral fields**, where innumerable holograms

Decoding The Hive

creation of gravity, light, time and the god particle

have been put in place to simulate alternative realities such as heavens and hells. The laws of physics within these realms do not function like they do for earth, allowing such rocket-propulsion crafts to navigate those realities, but human-man while in physical, manifest form here are not able to make this quantum leap, as their bodies would simply die from disconnection to the flashline sequence and life support that earth provides for that body. You would have to take on a completely different Avatar in that event. Those worlds were not condoned by, nor do they operate under the authority of the Emerald Council to the best of my knowledge.

NEUTRINOS ARE BOSONS

I cover all these explanations in order to show you as science-fact that neutrinos that are zero-spin are only delineated into Leptons once that neutrino has decided to strike an ion *to make baby atoms*. **Neutrino Leptons** are atoms (3-D particles) and **whole neutrinos** are **bosons** (interdimensional particles). Neutrinos are bosons, atoms are bosons, photons are bosons. Nothing exists that is *not* a boson which is only a *code word* for photon. In this instance they are calling neutrinos multiple different things, because the neutrino takes multiple different forms and they do so through command. Until they are about to interact with 3-D particles, they remain totally outside of the view of science; they act like photons, their signatures are dormant, yet when they do interact, they suddenly dispense enormous energy into the ion that carries the power to create oxygen and hydrogen in massive quantities. Science is well aware of the fact that oxygen, bosons, Alpha particles and Higgs Bosons are multidimensional particles and constantly interacting with atoms, they just don't bother to explain it in a way that people are able to readily understand because they constantly rename everything as if there are millions of different types of particles. There aren't. There are particles (waves) that are either on a mission, or otherwise they do not physically exist in any way, because that thought has not yet been cast into action and is still incubating in a Sentient being's mind somewhere.

And the way they have devised their system of placing thousands of different names into the field of particle physics is through ego. When "Dr. Whump" figures out what else a hydrogen atom later goes on to perform, then instead of calling that "hydrogen-to-whatever", they call it "the Whump Effect", leaving it up to you to figure out what the hell a Whump is then have to read 1000 pages of theories and experiments that Whump went through on his way to the Nobel Prize to determine that "hydrogen did this next". And since these particles can go on to do ten thousand different things, there are 10,000 different egomaniacal scientists all bronzed in the annals of physics with their names up in lights, making it effectively impossible to make sense out of anything.

The upshot is that when CERN *releases* a Higgs Boson inside one fixed point within the Large Hadron Collider hundreds of times performing tests to identify the existence of the *god particle*, the resulting particle isn't *flying off into space somewhere*, it is simply reacting (flashing as in photon illumination) to the artificial excitation of its cellular language (like shocking someone with a stun gun), causing it to produce a spark or emit color (spasm) it hadn't been commanded to by a Sentient being through thought alone, but by brutal assault. The actions taken by CERN and every other particle accelerator are forbidden by the Emerald Covenant because they are

Decoding The Hive

creation of gravity, light, time and the god particle

only looking to release disproportionate amounts of dark matter in order to use it in ways that disrupt the organic process of any evolution.

OXYGEN AND ALPHA PARTICLES

Oxygen at its quantum **Singlet** state, the most *oxygenating* portion of what is called oxygen (Deuterium) shares the unique characteristic of **Alpha particles** which are merely positive (+) bosons that have **Triplet state** ∇ spin-rate. The **singlet** particle (oxygen not-yet entered into active-duty, meaning it also breaks the laws of physics) goes under the scientific designation of **O** and the subcategory of **1 Δ g**, or Delta. Its unique Triplet state ∇ (Trinity state) is an absolute zero spin particle, just as the Higgs Boson (but carries a magnetic moment which is also breaking the laws of physics), and is symbolized by **3 Σ -g**. Is this **coincidence** that the fundament life-force of earth, oxygen, just so happens to be symbolized by the number 3, (**E**) Delta (**Σ**) and the fake letter **g** (also $\Delta = \Sigma$) which literally means ELOHIM ELOHIM ELOHIM in the **S@t@in Cϕphɛr?**

The Alpha Delta **neutrino** literally activates the power held inside salt Omega **ions**. Salt itself is *pure energy* that science has hidden inside the name **Halite**. This is **Halite crystal** (solid rocket fuel oxygen/hydrogen in its organic state) that goes under the technical name of **sodium chloride**. It is made up of pure ions (which is sentient salt crystals holding the form of hydrogen energy with oxygen as the oxygenator when merely exposed to a pulsation of the right frequency such as sun waves). Ions are the particles that are known of *as* energy, *as* oxygen and *as* hydrogen almost *exclusively* held inside Deuterium water. Neutrinos *activate* ion power, just like the sun's (*invisible*) frequencies activates ion power (**V**) *because sun rays are literally cipher code for the word neutrino:*

Decoding The Hive

creation of gravity, light, time and the god particle



Keep this description of salt in mind as you continue following the report on neutrinos. It might seem like a broken record now regarding this distinction that salt has been the hidden source of energy all along, but I feel it is imperative that the collective of humanity finally understands what has been the secret of the ages as will become more than just apparent as we see exactly how the god of gods in the material world has been deified and by which symbols:

Salt:

“An ionic compound composed of cations [+] and anions [-] that are held together by electrostatic attraction.” [Both cations and anions are ions that simply have opposing charges. Ions are pure, raw energy awaiting the command to open which is excitation by waves of electrical energy flow which is why your phone uses ions to run. When your

Decoding The Hive

creation of gravity, light, time and the god particle

battery is depleted, you can set it in the sun and recharge it. Maybe not as fast a recharger will, but it will recharge it, because it is the neutrino sun-waves that carry the energy into this field and the ions then carry that energy to the world through the form of crystals called salt.]

SAL(T)

The capital V (but shown upside-down of course, hence why I inverted the original 10,000 yr-old Signet for Sal in the graphic below) in the **S@t@in Cϣphɀr** stands for the names of *all* of the most ancient (and modern) titles in every pantheon of gods from An to Zeus:

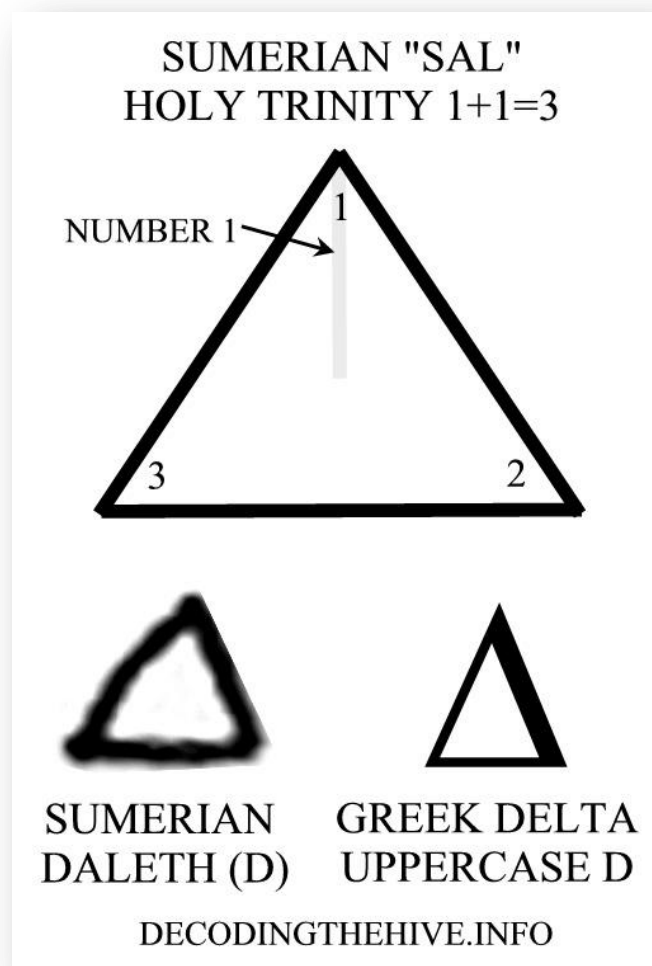

Just so you can begin to follow this prior to reading the entire volume later to come on the **S@t@in Cϣphɀr**, the letter A is **the primary** cipher for god. It comes from the letter D as in dog (the Delta Δ triangle), and the alphabets down through time have been **desrever** (reversed) as well as inverted repeatedly through history, so keep this in mind.

Decoding The Hive

creation of gravity, light, time and the god particle

In space (which means anywhere within the aether outside of the material, electromagnetic world), the Keylon Signets and command Templates have no right-side up, or vertical, as there is no fixed substrata below. That means that a Signet symbol that is sideways, mirrored, inverted or crooked is still the identical same symbol as before as far as the aether is concerned when hearing the command that the Signet is broadcasting through its standing scalar waves. It would need a reference-point in order for it to be treated differently by the aether, such as following a precisely-positioned symbol, and preceding another symbol to achieve a longitudinal/latitudinal reference. If the signet was made with a single rose for instance, if that rose is upside down or there are “3 roses” in the picture, it will never stop the single rose from projecting the eternal message of its command, but the other two roses will now also be broadcasting that command right along with the first one. It is called amplification of the command to group lots of Signets together. If the talisman (Keylon Grid) used “3 five-pointed stars”, then any group of 3 of those stars together will broadcast that spell. 6 of the same stars will just broadcast that much louder like turning up the volume of your radio.

*If the Command Template used triangles that were opposing each other in the first initial image that held the “song” of the command (talisman in today’s lexicon), to represent the full Hexagram, then the ones pointing UP would represent material reality while in an environment where there is such a thing as UP, and the ones pointing DOWN represents anti-matter where the energy is stored before coming into man’s use. Hence why triangles which were used for the G.O.D. Program Template are shown pointing upward when used by the dark forces such as in the Delta Δ , meaning that the entire program’s intent is to bring a material manifestation of the command to bear, as the top half of the Hexagram represents material reality. But with all other symbols such as Σ or other, it can be placed before you as an M or W or backwards and not **negate** the command. **E**, Σ , **M** and **W** are all the same symbols as **3** which began originally from the first grapheme symbol ω that stood for sal(t) that had been ∇ from the earliest days since the arrival of the Sumerians. Laying these on their sides (horizontal, referred to as the X coordinate) will represent “dead” or “cancelled” from what I can see, but that would likely only be indicated by a preceding or following reference-point additional symbol, just as Lattice Theory uses vector symbols in the “X” position.*

THE MATRON OF MAGNETICS

Energy has always been god in the most hidden of all terms, and the reason energy is even *spelled* beginning with E comes from the Elohim title. **Energy**, **Electricity**, **Electron**, **Elect**, **Election** (for a **Monarch mother**), are just a few examples of cipher titles that were coded to indicate god which are actually **G.O.D. Programs**. They were not here to worship a deity, they were placed here to make humans’ god-sparks (belief) power the programs. The Elohim are factually-speaking the most powerful beings in existence, so where power or energy comes from will be titles after them, and always as *the many* who make up *the single* entity, as they stand together.

Decoding The Hive

creation of gravity, light, time and the god particle

In the scientific descriptions of the three different elements within the Neutrino under the: **Electron Neutrino Lepton V_e** subset, the **E** stands for **electron**. Keep in mind that the electron is the *magnetic* (female) particle with a “-” to indicate it is *bringing in* energy. The neutrino (**sunlight**) is a **positive** or male particle that dispenses energy to the electrons (ions). The – **negative** sign used today is symbolized by the slit of the vulva (which was individually shown as a snake in pre-Egyptian times as shown in this section) and the + positive sign is symbolized in the penis with testicles. The female takes in sperm (positively-charged energy called **protein** which is a cipher for the word **proton**), then blends that with her life-force waters (Wawwu) to produce birth or life. In the same way, an **electron** particle will absorb the powers from the proton once brought together inside an atom in order to activate (birth) **energy**, a synonym for **life**. Identically, but on a quantum level, the ion (-) absorbs the power from the neutrino (+). Until then, the ion is static, as is the neutrino:

- **Electron (-)** is synonymous with **neutron**
- **Neutron** is synonymous with **female (MAtron/MAgnetic)**
- **Proton (+)** is synonymous with **protein**
- **Protein** is synonymous with **male**
- **Male** is synonymous with **energy**
- **Energy** is synonymous with **electricity**
- Without both – and + electric currents there is no **life**

THE ANUNNAKI PARTICLE

The universal scientific symbol for the **power** in electricity the average person just calls volts (we have already covered meaning Mu), is a V inside of a circle O (big surprise, as the circle represents the material world of earth, symbolized in the pattern an atom -Adam- creates): \odot . As already touched on, the symbol of the **Delta Δ** comes from the actual shape of the **Anunnaki Particle** called **Nabla: ∇** . This is the **Metatron virus particle cluster** that removed the top point off of the 6 point **Hexagram** as it first began to form while coming from **Static** electricity into **Magnetic** electricity, turning the **Angelic Krystos** eternal-life **Addami** particle into a **Weasadek Metatron Adam** code which is not a self-sustaining technology. Rather than relying on the unlimited power of the **Eternal First-Fields Standing Energy of god-source** that the **Krystos Template** provided within the **Hexagram Scalar Vibrational Science** used by the founders of the **15 Level Time Matrix of Gaia**, the **Elohim** inserted the **Metatron Pentagram Science** in its place as we have discussed already. The virus cluster I call the **Anunnaki Particle** disabled the pale-silver chord that connected the **Angelic Human** genetics to the **Standing Energy Fields**, and now all beings within the artificial, corrupted Avatars in place today are based on **Vampire technology**. This is the system by which an Avatar must feed off of energy that is taken or stolen from something or someone else in order to continue to power their vehicle. It is a closed loop system that has a finite lifespan, based on the **Vesica Pisces Program** vampire principle that can only operate off of energy that is contained within the **Time Matrix** itself that is being *reduced in power* for want of a better term.

Decoding The Hive

creation of gravity, light, time and the god particle

While new energy is continually delivered to this playing field by the Time Matrix, what is coming in directly from the **Deity Planes** and the **Eternal First Fields** that is key-coded to **Angelic Krystos DNA** is being refused by this virus, choosing to function off of energy that is of a lower frequency spectrum (like 6 volts rather than 12 volts). The Elohim knew about this finite energy structure before they invented the virus, but due to something I would have to speculate would be on the order of *patent rights* possibly, they were forced to use this inferior technology for humankind, due to limitations on what they could and could not do within this Time Matrix, based on treaties and covenants that predated their assault that would have otherwise made it impossible for them to destroy the **Divine Angelic Human Blueprint** without replacing it. This is just my own take on the matter. Either this, or it was simply a matter of them knowing beforehand that they would have to alter the Divine Blueprint in order to bring the Signature Spirit Essences inhabiting the corporeal bodies on this plane under submission. Regardless of why, it is now fact, and we just need to realize that our DNA carries the original blueprint that is able to come forward at any time once the Frequency Fence (along with the artificial moon) has been removed and the second sun has been reinstated. We can do this if we simply join together on this task. It is not impossible. Only what you deem as impossible, actually is.

This technology comes in from the top of the electronic waves within the spectrum of the Krystalline technology, attacks the genetic template, which inverts the pattern by which the energy now functions, turning the physical template upside-down in the process. It also reverses the top half of the two counter-rotational tetrahedrons to phase-lock into both **parallel-rotational** spin-patterns in a counter-clockwise direction. What you would see under a microscope would be a “crowned” circle initially, then as the nucleus of the Keylon takes on the distorted sound pattern of the song of its mission, it would physically invert. On a quantum level, when the Anunnaki Particle (virus) appears at the moment of inverting from **static** electricity (aetheric or multidimensional level) to **electromagnetic** electricity (3D level) where the strike-points first become visible to science, the **Aniline Krystal Seed Atom** carrying the **song** of the **intent** of that mission appears vertical, and the Anunnaki Particle is pointing downward, attaching itself to the top strike point within the event horizon sphere where the waves will be *bouncing off* that orbital limit that defines how large the cluster will be. Instantly the group, energetically-speaking, invert, turning the **Nabla ∇** into a **Delta Δ**:

Decoding The Hive

creation of gravity, light, time and the god particle

KRYSTAL SEED ATOM ANILINE

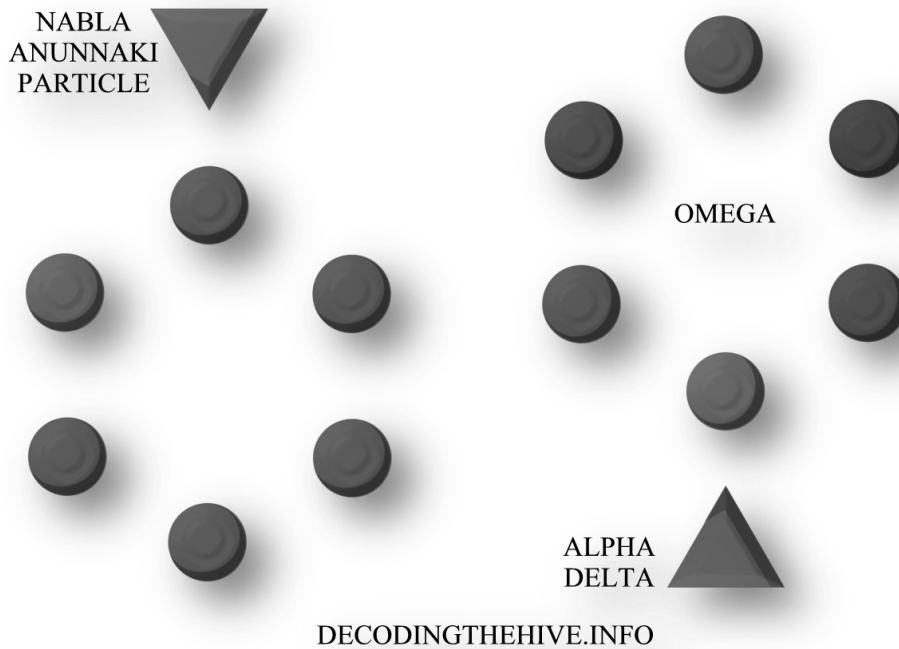

Using 2D drawings that represent this technology in actions on a **Keylon Signet Template** scale (or the quantum of what will later turn into a complex **Fire Letter**), showing the pattern that the waves inside the sphere will actually print out once they begin hammering out the song of the mission would appear like this. The blue hierophant on the left begins the transition of Partiki energy coming into the 3D plane, the middle dark red pattern then immediately appears, and then instantly inverts such as on the right. While it may appear like nothing to our eyes, this is the physical form energy takes when it is being hijacked and forced to perform within a counterfeit operating system:

Decoding The Hive

creation of gravity, light, time and the god particle

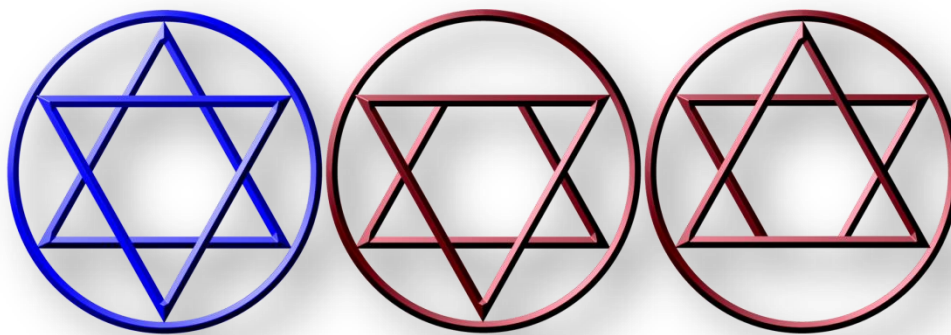

DECODINGTHEHIVE.INFO

So the pattern of the **pentagram** would be utilized by the **Elohim** sycophant (this technically means bootlicker, or someone who refuses to stand on their own two feet) army (**Anunnaki**) as *two different Program Signets*. One to represent the **hijacking** of the **hexagram** (pointing downward), the other representing the manifestation of the **success** of the program that is now in control of all material or 3D holographic projection (pointing upwards *to the heavens*). The **hexagram** would now fall into the same category as this within the **Command Signets** (based on how they are actually used today), as the pentagram now replaced the hexagram science, so the pentagram would now be used as another Program Command Signet for their side as well. The pentagram **pointing down** can be considered the foundation of their power, just like the **Anunnaki Particle** as it first begins the hijacking which stands for **Victor**. There is no chance this word was spelled as it is by accident. **Viceroy**, in **Vincible**, you get the picture. Once the capture and inversion happen, the Delta would then reign as god on this plane which is represented by the Δ which is the inverted Nabla ∇ .

This gets confusing again, because the Delta Δ now stands for Trinity, which means it has the power to rise out of this existence, and the earth-bound beings that are under the spell of the Anunnaki Particle Nabla ∇ will refer to earth-level beings which are “hexed” to remain in the 3D level. The **Nabla** in science has to do with vector-coordinating, or specifically regarding the location of the **Aniline Krystal Seed Atoms** or *aether particles* (light bulbs) that power the **spacetime fabric**. It should come as no shock now to you to learn this after we covered the use of the Nabla and the Delta hidden inside the Lattice Theory that used the analogy of a **lattice grid** for why math needed this type of precision treatment, using the **supremum** title.

This would be the **true symbol** for all **Scalar** and **Gauge bosons** as well as the “curl” **Nabla** that carries the hidden **X-factor** or **depth** of the pixel (intensity of the flash) that is represented like this: ∇x which would be the true scientific symbol for the **god particle** or **Higgs Boson**. Now you can see why it is when you look at the Delta and the Nabla up close, you will see that they are both showing a **very light line** connecting the peak points of the V, and the grapheme letter V itself does not actually fully connect, but **points** to each peak in the **serifs**. This was not by accident, as that line when inverted as a V is supposed to be aetheric or a veil which the Elohim can pass through easily, but earth-level beings are supposed to be bound by. This might be more information than you wanted regarding the Nabla V, but at least you have this in your random-access memory banks.

Decoding The Hive

creation of gravity, light, time and the god particle

Omega V electron ∇ **White Queen ion** ∇ is being used as the **slave** to bring **Red King Alpha Delta Δ proton** ∇ **dark matter** into the 3-D reality. The Delta Signet, pointing upwards, is a favorite symbol of the Sumerians in order to provide the required disclosures that allow them to claim that they were showing you the clues all along of your enslavement, which allow them to continue the masquerade, plus it physically reinforces the scalar command behind the Signet. The film **Constantine** shows this symbol but of course never mentions what the science is behind the power of the talisman. This is a **Primal Command Signet**, or **baseline-quantum** command (extremely powerful, because it would have so many Signets in place across the globe) for the creation of the **Chimera Reality**. The Voltage Signet points downward, indicating that it is actually the **original Anunnaki Particle**:



CHAPTER 25

THE NEUTRINO CΔΔΣ: MOMMA



I hope you are ready, because I am about to bring you home to meet mother. Sure, I have mentioned SAL(T) to you already, but she has taken more names since that very ancient time, which has played into the times we live in now, where her new name has been turned into

Decoding The Hive

creation of gravity, light, time and the god particle

hundreds of names of god and millions of **Keylon Command Signets** meant to keep us here eternally. SAL is energy, not a person, and “she” can be found in **Neutrino Events** as mentioned previously which we are getting to, but first we are going to cover a couple of things that will lead up to the CERN experiments in the search for Sal.

BLOOD AND OIL

Your body is powered by your blood. Your blood is red. The red blood that is mostly made up of water does not come out of your body when you sweat, only the clear water does. When you sweat, your body *tastes salty* because the crystals in that water are carried to **surface-body** level of your existence. What we call SALT is actually crystal that **carries** energy. That energy doesn't stop powering things just because the water evaporated (merely turned into gas, not *disappearing*), it goes on to power everything on the surface of your body through what are called enzymes that are specifically known of as proteins. Proteins are protons as you now know are scientific code words for energy. Enzymes keep your skin supple and able to breathe oxygen that keeps you alive and on surface-earth (not sinking to the bottom of the ocean or floating off into space), because they are carbon-crystal gravity particles that are at the same time anti-gravity particles known as hydrogen.

Earth's body is powered by her blood. Her blood is oil. When she “sweats” energy from her insides, that sweat is not black, it is clear, just like yours is. The water that transfers your inner-body energy to your surface-body is the same water that transfers her inner-body energy to surface-earth energy. When it arrives to the surface it tastes salty because the crystals that carry the energy can be recognized as having a flavor to your senses. Salt *is ion* energy. And when that energy reaches surface level for both you and earth, it is now reduced in power, just like stepping down 3 volts to 1.5 so your flashlight doesn't burn up while trying to power its bulb. The ions that are inside the salt that were activated by neutrino sun-waves are now *ready for work*, because that energy has transmuted from higher dimension into the frequency spectrum of your 3rd dimension.

Here's a little secret; your body doesn't need the super-powerful red blood energy to be on the delicate surface of your skin, it only needs that voltage of current inside the body where your major organs are relying on stronger energy to process food (which it turns into electricity through fission/fusion reaction). Otherwise, the lower-voltage energy delivered by the water is more than enough to power your skin. The same is true for earth. Only when her skin is damaged will you see her blood (oil) rise to the surface, where it is not needed, not wanted and where it will do damage instead of good for that level of her body.

The actions shown in the **Neutrino Event** (still coming, so hang in there) below of the neutrinos (*Dads*) colliding with **protons** (*Moms*) in this mating process are actually **ions in stasis** which make baby atoms that are now **electromagnetic**. The gift of life for all atomic energy is the gift of *magnetism*. The mating ritual as photographed shows that the way the babies are created defies what we think of as natural physics, as the particles don't shoot directly away from the impact, but they actually travel backwards, from where the neutrino came from. This creates an

Decoding The Hive

creation of gravity, light, time and the god particle

arrow ↓ pattern. This is because they are striking a crystal which is then “bursting” toward the direction of contact, and then off in directions opposite each other, because each energy cell has its own path it must follow to run its own portion of the race to get your song from *here* to *there*.

As mentioned, neutrinos and ions take the path they are commanded to within this dimension in order to pass the baton to the next pixel. Often, the baton is handed to two or more runners at the same time. Some curve continuously, some travel in straight lines. When they interact, then the signature of their next response lays out a course of action. *Once again* I am being redundant; understand that all these particles are not *actually* moving at all. Just like on your computer screen, the pixels NEVER MOVE, but rather they cause progressive quadrant-vector points to light up one at a time to pass along the message of the full mission to the next quadrant-vector pixel. How the light then *scatters* once the mission reaches that exact point in its mission indicates which leg of the race it is going to pass along to the next pixel. And just like the runner’s footsteps **print** on the dirt either beginning to curve around the track or straighten out, or begin curving the opposite way at his point in the race, so does the light (sound) print out an **intent pattern**. The pattern of his footsteps shows you where he is headed to next, and the pattern of the neutrinos and their *next runner* they pass the baton off to do as well. Those **patterns** are **SYMBOLS** that your captors have recorded and encoded into your alphabet to indicate exactly which TURN the aether particles are coded to make next. By using them, the aether **hears** their command and reroutes its course in the race. ALL the pixels can see and understand the command being given them from the scalar-waves held in that symbol.

When ions come into this atmosphere (that *hold the electrical charge* for want of a better explanation), they too print-out a **standing pattern**. The ion is speaking to the neutrino what *type* of ion it is, and what level of energy it is dispensing. Think of ions as each one having a different level of voltage and serve the perfect level of energy to certain pixels that are about to produce a very dim shadowy section of a bird’s wing, or extremely high energy amount of power for a pixel that is holding the image of a super-powerful laser beam let’s say. In the case of certain rocks which we mentioned regarding the cobble-stones surrounding the Zeta/Draco Frequency Fence Obelisks such as the one in Saint Peter’s Basilica and others, you can merely drill two holes into that stone, insert an iron rod into one and a copper rod into the other and power your device from it. As long as the sun continues to hit that stone, it will continue to generate energy. Most rocks will work this way, and even concrete will as well because it is made up of sand which is actually crystal. Neutrinos also recharge these stones, just like they are continually recharging the ions in the water of the ocean. Obviously the levels of energy will differ:

IONS AND ORGANIC VOLTAGE

*To briefly explain what I mean regarding voltage difference in what powers the planet, let’s say that very low energy ions would **print** across the spacetime fabric that **they are an X level of power, like 1.5 volts**. An ion carrying the codes for **3 volts** might print out a pattern that looks like a **heart shape**, and an ion carrying the keys to unlock **12 volts** might print out the letter **e**. This would go all the way up to the letter **A** pattern equal to let’s say **110 volts** within the parameters of this example. The patterns are real. The ions*

Decoding The Hive

creation of gravity, light, time and the god particle

carrying the energy are there, surrounding every quantum pixel of your air space at all times, continually printing out their signature in the sky and the water as it were, like lights down both sides of a runway telling the plane where to land, but of course much smaller than you could ever see with the naked eye. The neutrinos carrying the “second key” to unlock that level of power (just like a nuclear missile bunker requires two different officers to insert different keys to unlock “the red button” before someone can fire the missile), seek out that precise power level pattern to strike and then activate. Your captors know which ions carry which level of power and those patterns, along with the neutrino patterns striking them and the resulting geometric symbols are all coded into your alphabet so that your words will direct strategic energy-release that are needed to properly power the INTENT behind the PROGRAM they have place behind that symbol.

The **Love Program**, the **Pornography Program**, the **G.O.D. Program** each have different ions they rely on to generate their own power to manifest that intended result (color) where people feel a massive energy-release when presented with the *show* they are supposed to act out. Remember, *Programs* on radio and TV are *plays* which require *actors*, and **Programs** set up by the Illuminati require actors as well. Those actors are always you. And when you see the patterns printed before you (or spoken to you), you will feel a nudging to take up that baton and act out your role in that *play*. If you don't think there is a scientific reason your entire body fills with emotion when you hear the word Christmas, then you aren't following along. More people die on Christmas day than any other of the 363 days of each year because of what I'll call the **Manger Program** that causes people's hearts to go into what is called *Cardiomyopathy* where the heart literally loses its will to live and dies because that person put their faith in an expectation for that day that never came about, because Christmas wasn't designed to actually bring you joy, but the exact opposite. But the plays being acted out here have been developed over millions of years and perfected to a point where they feel awesome and give you a deep sense of hope for joy. But the joy never actually comes because they are under the **HOPE Program** that is designed to seem like one thing, but secretly set you up for your biggest disappointments. All of which are designed to keep you just barely alive and breathing.

I haven't even begun to scratch the surface yet on all the Programs the Illuminated ones have in place (which I will get far deeper into as we progress), but each Program is coded by both the neutrino's pattern and the ion's patterns within the letters that spell out such schemes. Christmas is the most successful of all the **Holiday Programs** in existence, and every letter within that ciphered title will be found in these sub-atomic particles' geometric patterns. Christmas is NOT spelled Cristmas. The hidden h is there to carry the extreme power of μ that this particle we are talking about now, the neutrino **Lepton Muon** carries. The symbol for μ in Greek symbols is printed using the letter **m** on your keyboard, surprise. The letter **m** is THE CODE for mother-god, it is THE CODE for ion and it is THE CODE for salt. The symbol μ is the h, n, u, m, w, Y, and more. At the quantum of the μ or “where it comes from” is from the “pretty pictures” printed out by ions while in stasis (protons), signaling what voltage that particular particle is carrying. I will be showing you exactly how the “w” of water turned into μ along with all the other letters above when we wrap up this subject. **Holidays**, **Holy**, **Hallowed**, start with μ , and **Christ**, **Christmas**, **Christian** carry the *silent h* as in *Silent Night* (not *Silent Nite*) to tell you what *octave* to sing that hymn (with a silent n at the end which is also μ) so precise quadrants within your

Decoding The Hive

creation of gravity, light, time and the god particle

reptilian brain will fire and trigger the sensation of reverence and solemn (with a **silent μ** at the end in the letter n) obedience to the power.

THE NEUTRINO EVENT

Neutrinos have been photographed as mentioned above. This experiment that yielded the **photograph** below was done using incoming neutrinos and ions that filter through earth every second of every day through the sun portal (ultimately from the Deity Planes), and then captured interacting at this precise quantum level. This event shows that some of the neutrinos **collide** with ions that hold the energy codes within this field. Not many of them, but a few. When they do, the job of the ion particles is to recharge the crystal stationed at that pixel vector. I explain in detail later that the primary contact that neutrinos and ions have on this plane is oil held below the mantle of earth, recharging the energy in the crystals held in the liquid oil that then recharges the surface-earth energy-dispensation vehicle called Deuterium which is water. But neutrinos also obviously strike ion protons in water as well as shown here in a bath of Deuterium.

The **straight lines** are **neutrinos** and the **squiggly lines** are **Krystal Seed Atoms** science calls **Anilines** or in more ambiguous terms, **ions** and then in even more ambiguous terms as **protons**. The neutrino's straight line (prior to striking the ion) is the numeral "1" in your math, and I, i, in your alphabet. Every curved numeral (3, 6, 9, 0) or portion of letter (a, c, e, u etc.) in the alphabet are ions. By now, if you know anything about vortex math, you are beginning to see the pattern yourself). **Protons** are **ions**:

Decoding The Hive

creation of gravity, light, time and the god particle

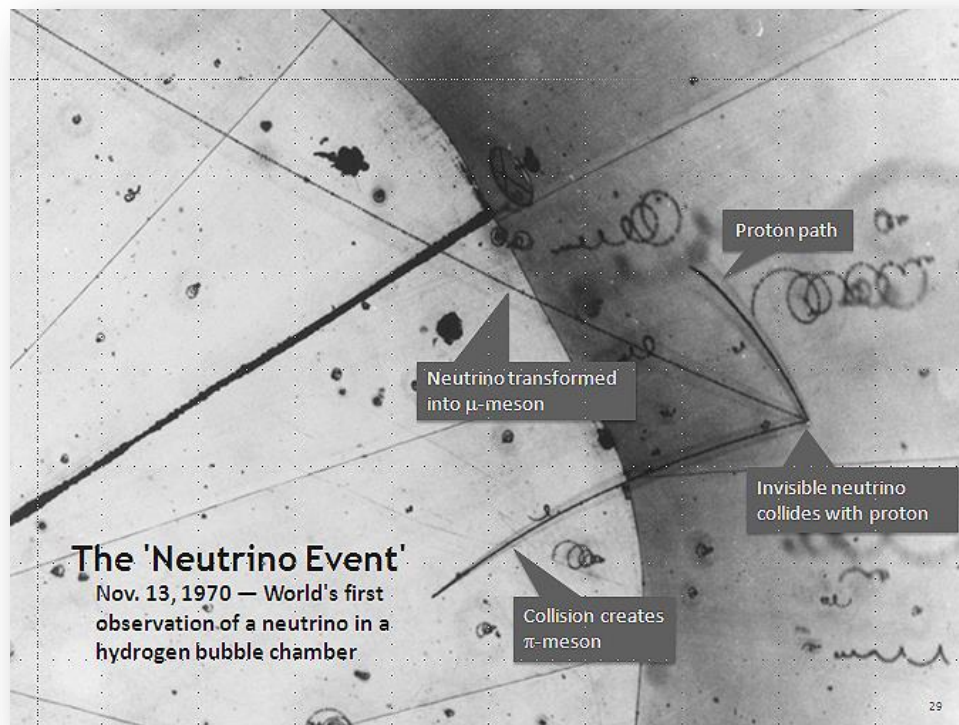

The squiggling ions above are in the dimension (or the “level” of frequency) that the Bubble Chamber cameras are focused to. The *dots* are in lower frequency dimensions (smaller), but are also squiggling just the same. All are awaiting their next message about *what to do next* delivered by the neutrinos. The two interact with differing mission commands for different roles for that precise pixel to pass along to the next pixel.

An ION in its resting state is printing out its symbol and awaiting command from a neutrino. This is *electricity* in its quantum state as shown in the Neutrino Event above. Remember also, the Neutrino Event was performed using a **block of salt** hollowed out to hold absolutely pure, salt-heavy, **Deuterium water**. Also keep in mind, these are not drawings, they are the actual neutrino and Aniline ion trails themselves. Perhaps you know now why *the most powerful* (Ξlectricity-laden) Holiday Program, Christmas, is also called Xmas:

Decoding The Hive

creation of gravity, light, time and the god particle

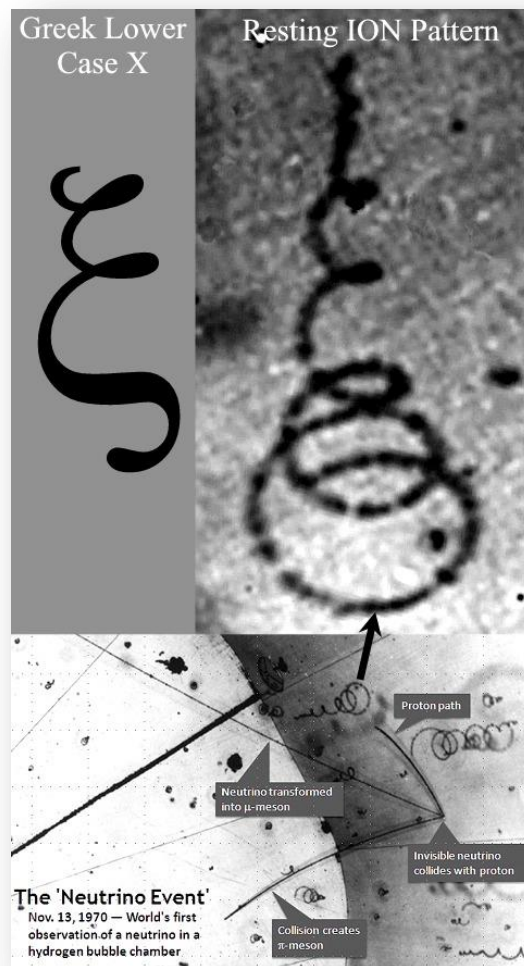

As the incoming neutrinos entered the pure saltwater bath, one struck a proton, breaking off an additional meson. The meson is another term for the word electron, and “decays” to form another neutrino as explained by [Wikipedia](#):

Meson; “Charged mesons decay (sometimes through mediating particles) to form electrons and neutrinos.”

This is the activation of the meson (electron) for its role now as a 3rd Dimensional energy particle now carrying **magnetism**. And notice that even though the neutrino created a whole new electron, the original neutrino was never lost at all, it just continues on its same journey activating more and more electrons (like the Mac Daddy of energy). The pattern it makes is an arrow shape (wedge) that just so happens to be exactly the symbol used by the Sumerians to depict the most powerful life-force on the planet that also bears life-force they called Sal (common name for salt).

Decoding The Hive

creation of gravity, light, time and the god particle

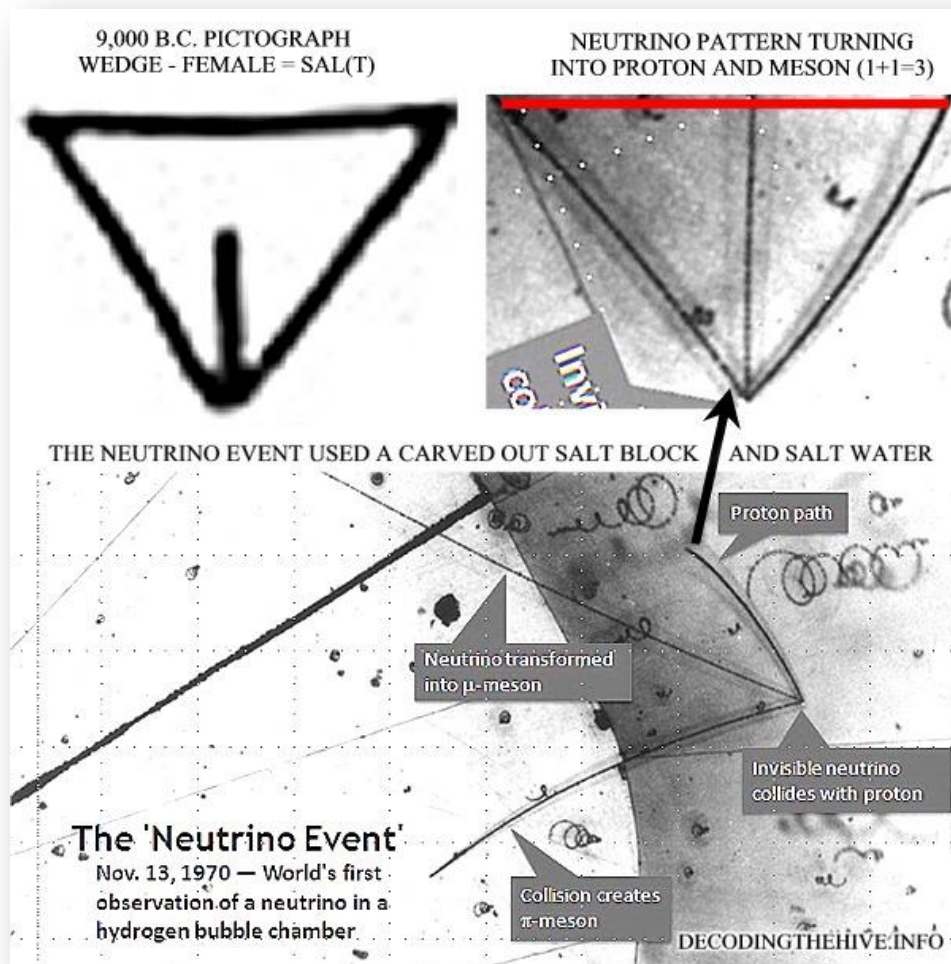

SCIENCE AND SYMBOLS

Ignore the dating on the first symbol in this chronologic table; the vertical SAL(T) symbol has been dated to thousands of years prior to 3000 BC (and likely hundreds of thousands prior to that, but such evidence likely disposed of by the Smithsonian Institute). But because that doesn't fit into the biblical "total earth history of 6,000" years agenda, and the ages of kings from the Sumerian Kings List of some being tens of thousands of years old "doesn't make sense", *pre-cuneiform* pictographs (cuneiform beginning around 2500 BC) are assumed to be much more recent than accepted timelines. Alaljar/Allala (another name for Marduk) alone ruled in Sumer-Ur for 36,000 years during the 241,200 years covered in the **Sumerian Kings List** predating cuneiform text. This was antediluvian commercial **slave-trading script** used in Babylon:

Decoding The Hive

creation of gravity, light, time and the god particle

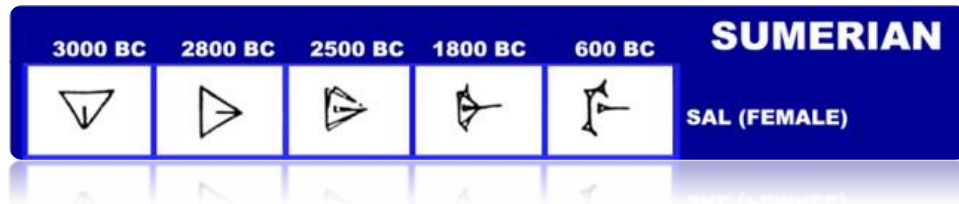

Much later after the Sumerian alphabet became a tool for everyone to sound out individualized, grapheme letters which could be used for documenting everyday affairs other than strictly business, the symbol for SAL was broken down into different components to represent individual programs behind the one image of the SAL vector symbol, making the ONE Keylon Template that originally stood behind this image overshadow every single Program that rolls out in these end times (that had stood as the “one” spell over mankind for millennia prior). These are the exact **same four lines** within the original alphabet of these times that stood for god (An, Anu-Elohim), making SAL(T) *synonymous* with GOD:

9000 B.C. SUMERIAN
"AN" (GOD) 3 LINES
PLUS "1" = 2 CRUCIFIXES

VIBRATIONAL SCALAR
SCIENCE KEYLON
GRID TEMPLATE

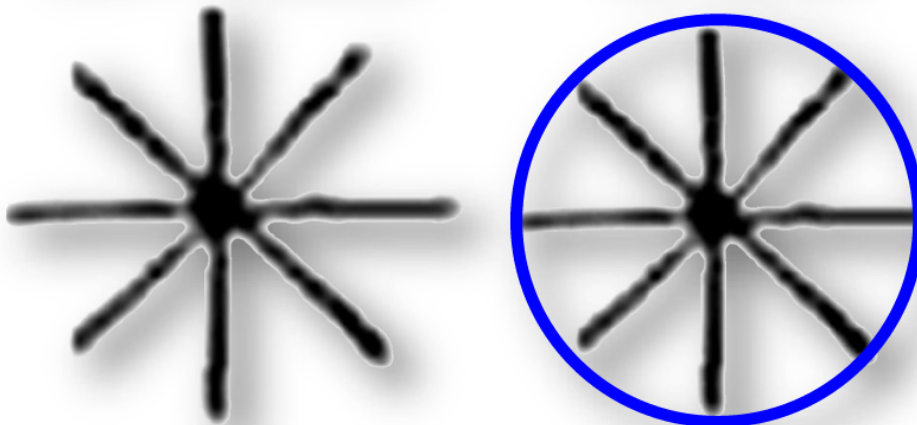

That one image carried the scalar waves of *every ruling-code* now carried inside the current Latin alphabet and every number in our fake mathematics. As was explained from the start, *In the beginning was the word*. The Word was the sound that created the first geometric template that would carry forward the **Fire Letter** of the overall **intent** behind the enslavement of mankind from the G.O.D. Program to the Magic Money Program and every Program you could imagine, and millions more that you couldn't. The original **3 lines** of the **Primal Command Keylon Grid**, then with this **added 4th line** that represented AN, are the 3 lines of the Primal Grid plus the **Anunnaki Particle** we have been covering that physically appears to quantum scientists in the shape of the Nabla, which just so happens to be exactly the same pattern printed out by the **Neutrino Event** previously shown, which just so happens to be exactly the same **pictograph** to stand for SAL(T) ▼. Remember, “sticks” show the sub-quantum original CODE

Decoding The Hive

creation of gravity, light, time and the god particle





of the Keylon, then the pattern the waves print out show the “pictograph” pattern, making the symbol you see above, exactly the **same** pattern of the **Nabla Anunnaki Particle**.

The four lines inside that symbol literally creates every single letter in the Latin alphabet that is now transliterated into every written language used by every race and every philosophy in existence today. It was the *one* symbol that encompassed *the* “hex” or “spell” so vast it would be impossible to even count much less decode within an entire lifetime. The organic shapes printed into the air and water by the neutrinos and ions at their quantum level are now used as symbols in **science, math** and **particle physics** that are **geometrically coded** to this symbol. The organic quantum shapes (used in lower-case letters) were then coded (transliterated) with **Keylon Template Scalar Science** straight lines \oplus then used in numbers and CAPITAL letters. Sal was cast into code (spell) by the original 3 lines in the first Keylon with the title “number 1” placed inside that template. Notice the symbols used to stand for capital letters are NOT the same symbols of those capitals, and every single lowercase “letter” can be found right there in the salt water, printed out by standing **Aniline ion Krystal Seed Atoms**. Here is just the **tip of the iceberg**:

Decoding The Hive

creation of gravity, light, time and the god particle

<p>9,000 B.C. PICTOGRAPH WEDGE - FEMALE = "SAL"</p> <p>CLOSED PURSE - BUNNY - GIRL</p> <p>WRITTEN W/ CUNEIFORM WEDGE</p>	<p>W - WOMBman - SIGMA - WEDGE TRINITY - CROWN - OMEGA</p> <p>NUMBER 1</p> <p>SPLIT</p> <p>OPEN PURSE - BIRTH - WOMAN</p> <p>LOWERCASE OMEGA (W) LOWERCASE V</p>	<p>M - MARY - MARDUK - MOLOCH H - HATHOR MARY - HERMES</p> <p>LOWERCASE M LOWERCASE H</p>	<p>A - ALPHA - ANU - 1 - 9 - ANUBIS</p> <p>NUMBER 1</p> <p>SUMERIAN ALEPH (A)</p>
<p>HOLY TRINITY 1+1=3</p> <p>NUMBER 1</p> <p>SUMERIAN DALETH (D) GREEK DELTA UPPERCASE D</p>	<p>V - SERPENT - SATAN - SAL N - NIMROD - NINKHARSAG</p> <p>NUMBER 1</p> <p>GREAT EARTH MOTHER</p> <p>LOWER AND UPPERCASE V LOWERCASE N</p>	<p>GOD / DOG - DAGON - DRAGON</p> <p>SUMERIAN LETTER DALETH (D)</p>	<p>A - ANU - K-9 - ANU-BIS - KHANE KING - KLEIS - KEY</p> <p>NUMBER 1</p> <p>SUMERIAN ALEPH (A)</p>
<p>B - 3 - 13 - 300 - BAAL - BIRTH BAPHOMET - BULL OF MOLOCH</p> <p>TWO ZEROS TWO AS</p> <p>SUMERIAN BETH (B) LOWERCASE OMEGA (W)</p>	<p>E - EL - ELOHIM - ENOCH X - 3 SEVENS + 1 = SWASTIKA</p> <p>UPPERCASE E LOWERCASE X</p>	<p>U - UTERUS - Y - YESHAWUA CRUCIFIX YEHOVAH</p> <p>UPPERCASE U UPPERCASE Y</p>	<p>C - CROWN - CROSS - CRUCIFIX CHRIST - CRONUS - COHEN - CUNT CLITORIS - V/W - VESICA PISCES</p> <p>SUMERIAN LETTER D ETRUSCAN LETTER W</p>
<p>proto-Sinaitic 2000 BC Phoenician 1100 BC Hebrew Greek 800-600 BC Etruscan Latin</p>			
<p>symbol word means symbol name means early classic modern symbol name symbol early modern</p>			
<p>Ω Ψ /sh/ shin → W /sh/ shin tooth? ψ → Ξ Ξ Σ Σ σ σ /s/ sigma → Ϛ Ϛ → Ϛ S s</p>			
<p>Ⲁ /3/ 'alep ox → Ⲁ Ⲁ /3/ 'aleph ox Ⲁ → Δ Δ Δ Δ A A α /a/ alpha → ϱ → Δ A A a</p>			
<p>Ⲁ /b/ bayit house → Ⲁ Ⲁ /b/ beth house Ⲁ → Ⲁ Ⲁ Ⲁ Ⲁ β B β /b/ beta → (Ⲁ Ⲁ) → B b</p>			
<p>Ⲁ /d/ dalet door → Ⲁ Ⲁ /d/ dalet door Ⲁ → Ⲁ Ⲁ Ⲁ Ⲁ Δ Δ δ /d/ delta → (Ⲁ Ⲁ) Ⲁ Ⲁ D d</p>			
<p>Ⲁ /f/ Ⲁ → uu → Ww</p>			
<p>8</p>			
<p>DECODINGTHEHIVE.INFO</p>			

SAL once broken into its "components" was first introduced as a fish (which is the direct image of an open Vesica Pisces version of the vulva:  in proto-Sinaitic times), then later in Phoenician times reverted back to the triangular SAL only now on its side:  with the inside numeral 1 now following down in the form of a tail. Later, SAL was inverted by Early Greek: , then ultimately turning into what we use as the letter **D** (for Deuterium), but still symbolized by Delta:  in Greek today. When it comes to **signet**-fying electricity, power and energy at its highest level, **the most** deified symbols within the written language are used, those that stand for the most aggressive, comprehensive and sweeping of all **god letters** spoken of in this report.

MOTHER OF ALL LIFE: MOMMA

Decoding The Hive

creation of gravity, light, time and the god particle

The FIRST fake god of ancient Mesopotamia (Sumeria) was the goddess of the **primeval waters** of the deep now called **Nammu/Namma**, previously called **Wawwu**, mother of **Enki** (Enki is equated with **Marduk**, the **androgynous** god of the waters). Realize that different names of god do not refer to *other gods*, they refer different **G.O.D. Programs** which are **offices**, not **one specific person or being**. The **Waters That Bring Forth Life Program** has been the ultimate **G.O.D. Program** since time began for the invader races. After Nammu passed away (because these physical beings worshipped as gods, do eventually die), Enki simply took over the throne of this deification. But before Enki/Marduk, before Enlil, long before the Greek name Zeus (who was **also** Enki/Marduk from Sumerian times) and before any other deity, was **Nammu**. Prior to that, humans didn't worship any god, because they knew clearly that they were manifest on earth **as** members of the actual god family and there was no need to deify anyone.

The symbol for the goddess **Namma/Nammu** (originally spelled **Wawwu** as in *water*) was a circle with a tail **♀**, the primordial genesis of the letter **Q**, but **ciphred** into the modern letter **F** today. The letter **N** now used to spell Nammu is obviously an abbreviated upside-down **W** which is both **N** and **M** in cipher (**N** has been used in place of **M** down through the ages as the same letter, and **M** has been **synonymous** with **W** across thousands of languages depending on the era of the lexicon). This goes for the letters **u** and **a** as well. Once the name (title) **Wawwu** was inverted (as all alphabets continually reversed and inverted), the **pronunciation** in modern phonetics would be **MOMMA**. This title has been uttered in every language-equivalent by virtually every being ever born to the mother that gave them life in honor of Wawwu. You honor her today with **Mom, Momma, Mommy, Ma, Mam**, (where **Madame** originated), **Mammy, Mum, Mummy** (her death would have been the very **first** mummification), **Mumsey, Nan, Nanna, Nanny**, then later as **Ninny, Nin** and **Nun** because her name changed linguistically to **Nin MA/Nin Hur SaG** (who was literally called **Mamma** in the most ancient of times). **Mammary** glands were even named in honor of this same deity and the original shape of the **W** was by no coincidence shaped after them **ω**. Of course that symbol for breasts is not actually now lower-case **w** today in your alphabet; it has turned into the **modern letter S** as in **Salt**. By now you should have no difficulty understanding why, since the word female (all her female children) was originally the word **Sal**.

The word **SIS** now comes from **SAL**, so **sissy, sis**, and **sister** (as in Catholic church Nuns) are from this same genesis. Remember, the word genesis was literally coined as a deification of this same OFFICE to stand for the **Gene of Isis**. Isis is literally the "ONE" **SIS**.

"Yes ma'am" is literally telling the god **MOMMA** that *you will obey*.

The collective **AN** group that Wawwu represented on earth, the **Elohim SUNS** of Ba'al, were aetheric, meaning when they visited this plane, they were in **Merkaba** vehicles and were present only virtually (as fire, light, etc.) Wawwu was their physical, on-earth ambassador in the original Sumerian invasion of earth. No other **manifest**, real-life being that has ever lived since humans arrived on the planet 560 million years ago has been honored, cherished or loved even remotely as much as Wawwu, whether they knew her real name or not. The closest second-place would be Jesus, and even that is absolutely of *no comparison*. Through **thousands** of different transliterations, spellings and languages down through the ages for the name **Wawwu**, from

Decoding The Hive

creation of gravity, light, time and the god particle

Hathor to Ishtar, Lilith, Isis, Shiva, Indra and Mary, and **88** different articulations in modern times, her name pronounced in English today is **EVE**.

The alphabet symbol for Nammu/Wawwu **𐎗**, asexual “consort” of **AN**, is now transliterated today into **F** in the modern Latin alphabet simply because the original grapheme letter held the **three lines** just mentioned of the original **Keylon Grid Template**: **𐎗**. From that **F**, an additional line was added to stand for the **Elohim** being present in material manifestation: **𐎗**, which Nammu/Wawwu would have to give birth to for them to be able to breathe the air of earth. Her symbol **F** was then used of course to stand for **FEMALE** god, or the highest possible corporeal **form** of the **Elohim**. She is the quantum, **baseline** of existence, that is why the **smallest** measurement is a **FEM**tometre, and the **scientific symbol** for that is “**fm**” which is **exactly** like printing out: “**𐎗**”. These are exactly the same two letters that stand for **frequency modulation** itself. In real, and even more hidden terms yet, the Wawwu (**birthing** womb) symbol translates to the letter **O** which is merely a derivation of the original **Q**.

Not only does **Q** stand for Wawwu in the most ancient of times, but **Q** literally stands for **Electric Charge** itself in science:

Wiki: Electric Charge:

*“Electric charge is the physical property of matter that causes it to experience a force when placed in an electromagnetic field. The symbol **Q** often denotes charge.”*

The original Sumerian/Phoenician **Q** was turned upside-down in modern Greek symbols to **δ** (**Delta**) which is now shown as the lowercase letter **d**. And UPPERCASE Greek letter **D** prints out as **Δ** as covered in-depth already. The letter **O** (**Q**) also stands for the fertile but not-yet-given-birth **wOmb** and it also stands for mother earth itself (keep this in mind, as the **wOmb** is what captured and enslaved humans, so when you see any sphere **O** with *something inside*, it **always** means **enslavement of Angelic Humans**).

*This means that the **Q** for Wawwu which is actually an **O** with or without a **visible** tail at the bottom, now printed out in Greek as the Delta **Δ** is directly transliterated to the uppercase letter **A** and by default to the lowercase letter **a**. So the captured and enslaved offspring (**a**) coming from the **wOmb** of Wawwu under the Recycle Program, will look exactly like this: **@**.*

This symbol when indicating *birthing mother* as mentioned takes the form of **Q** with the “tail” today, with the child/waters coming out below running off on an angle, but in the original Wawwu Signet or Sigel, the child (and the birthing waters) run straight down out of the **O** (**𐎗**). This is how the neutrinos and ion particles *gave birth* to the alphabet and also spell out the titles of god and carry the enormous volume of **Keylon Template Commands** that run their innumerable Programs of enslavement. Keep in mind that the conversion of ancient symbols to grapheme letters that reversed and inverted and augmented to create your alphabet **spell-**

Decoding The Hive

creation of gravity, light, time and the god particle

saturated cipher to now stand for all these geometric Command Templates has been verified by Council, so this *is not* a wild goose chase.

The symbol for the *closed* wOmb (shown in great detail again in the chapter CUNT in the upcoming full **S@t@in Cϕphϛr** later) is **SAL** (salt), or **Delta Δ (O)** as in not yet having given birth. Amniotic fluid or *birthing waters* was more than just a big deal to your captors, so even from the very first pictographic alphabet in existence that covered the basic needs for strictly *business* communication as just covered where humans have **always** been a **commodity**; this highly specific term was symbolized even then. **Modern transliterations for the term “amniotic fluid” in ancient Sumerian is the letter A.** Examples of exactly how all these symbols were turned into modern letters will be covered in great detail in the upcoming volume **The S@t@in Cϕphϛr**, but there wasn't time to squeeze them all into this initial report that needs to be landed into circulation prior to the peak of the **Stellar Activation Cycle** which is now only weeks away. However, there will be more examples to come already recorded as you will see soon.

WAWWU IS CODE FOR EVE

Here is the image of the mother-goddess of “*all life in the universe*” according to the most ancient of texts and referred to as the original, **single** (asexual) **universal** god of the **cosmic subterranean ocean**. The word Ocean starts with the **O** of the wOmb. It also starts with an **S** (as the modern symbol for  that spelled the first Wawwu) in Holy Sea with an **a** – not “See” as spelled by the church. By now you know that sea water/ocean water (and below as in subterranean) is Deuterium, or GoD, hence why Deuterium has the **scientific symbol D**, as in the Greek **Delta Δ** for the letter **D**. Spelled in ancient-ancient times as Sal(t), spelled in proto-Siniatic times as Wawwu/Nammu is now spelled in modern times as: e-V-e.

Here she is holding up a dish of birthing waters above her head:

Decoding The Hive

creation of gravity, light, time and the god particle



Nammu/Wawwu showing how the closed-purse of the wOmb gives birth which then becomes a MOMMA:

ORIGINAL BABYLONIAN EVE MOTHER OF UNIVERSE AND SUBTERRANEAN COSMIC WATERS

EARLY SUMERIAN
PICTOGRAPH: SAL
Virgin Female

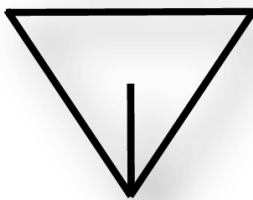

SUMERIAN
SAL M \overline{Q} MMMA
Giving Birth



SUMERIAN
STATUE
WAWWU



PHOENICIAN
GRAPHEME: WAWWU
Latin: F,Q,U,V,Y



DECODINGTHEHIVE.INFO

For anyone who may have imagined that the SAL(T)-to-WAWWU connection was merely a stretch of my imagination or that the Greek symbols used by science were randomly chosen, this is just the tip of the iceberg below (image on the left was taken directly off of Wikipedia under the summary of **Neutrino Lepton Electrons** describing how neutrinos strike **photons** – which is what they call **resting ions/protons**- to form salt and **CREATE** electricity. It is the *physical pattern* printed out by the particles during the act of bringing electricity to life. Keep in mind that

Decoding The Hive

creation of gravity, light, time and the god particle

the S for Sal now called Sigma was used many hundreds of years after the Phoenician symbol for Wawwu, making them both equally relevant to represent both halves of the actual reaction of the particles. At no time in history have I found both the V of the strike and the resulting salt ions floating down having ever been used openly as grapheme or pictograph alphabet symbols since the arrival of the Anunnaki:

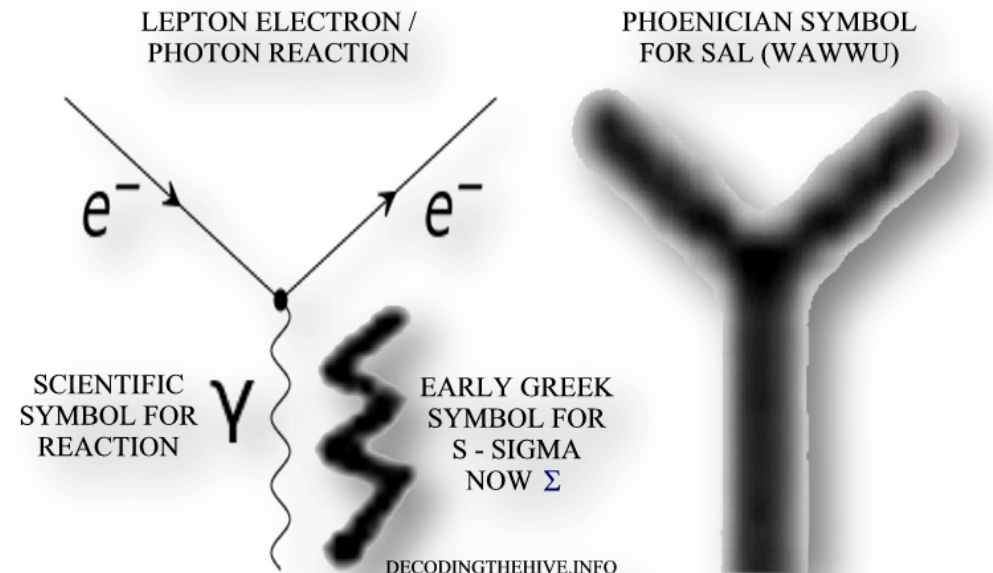

EVE IN A NUTSHELL

- The very first original Sumerian pictograph symbol for Eve was the Nabla Anunnaki Particle ▼ which is a Y with the tail moved up inside ▽
- The first original Sumerian grapheme letter shape of what is **now the letter S** symbol for S-a-l but now spelled E-v-e today was ω
- The Greek symbol for electrical shock **using the letter S** prints out the actual **scientific symbol** Σ to stand for the public **electricity** signet Ⓢ used inside the original ▽
- The **keyboard letter S** that now types out Σ in only Greek also stands for electric **shock** hazard used in proto-Siniatic times to stand for water ⚡
- The first original Sumerian grapheme SIGNET symbol for Eve was ♀ changed immediately later to Y
- The actual physical shape of the **Krystal Seed Atom** called **Aniline** from a quantum-level as photographed is the same symbol ✨
- That same symbol is now shown in the **scientific symbol Q** for **electrical charge** ♀
- The physical pattern of Leptons making **Aniline crystals** is Y^c
- That scientific symbol is shown by science printing out the name eVe, or **Enki** vs **Enlil**

Decoding The Hive

creation of gravity, light, time and the god particle

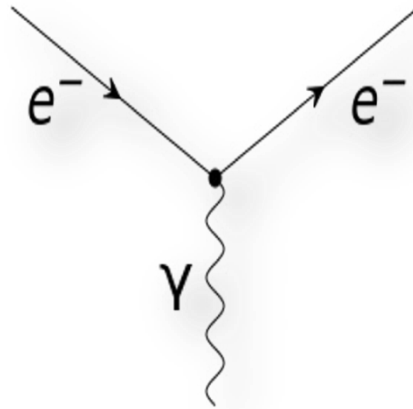

KRYSTAL SEED ATOM ALPHA AND THE OMEGA

But the connection of Sal(t) to Momma Eve doesn't end there. The Nabla Anunnaki Particle also represents the line coming down out of the Wawwu (Qoppa), which is now the curly tail of the Q (science symbol for oxygen), as shown in the original, quantum pattern that the particles physically appear as under electron scanning microscopes that is obviously the numeral 1. The mOmma giving birth to the HyksOs hybrid child is also the number 1 "chOsen" and still are as far as the Elohim are concerned. The out-of-round center of the oxygen ocean atOm (Adam) **O** is the Omega:

KRYSTAL SEED ATOM ANILINE - EVE

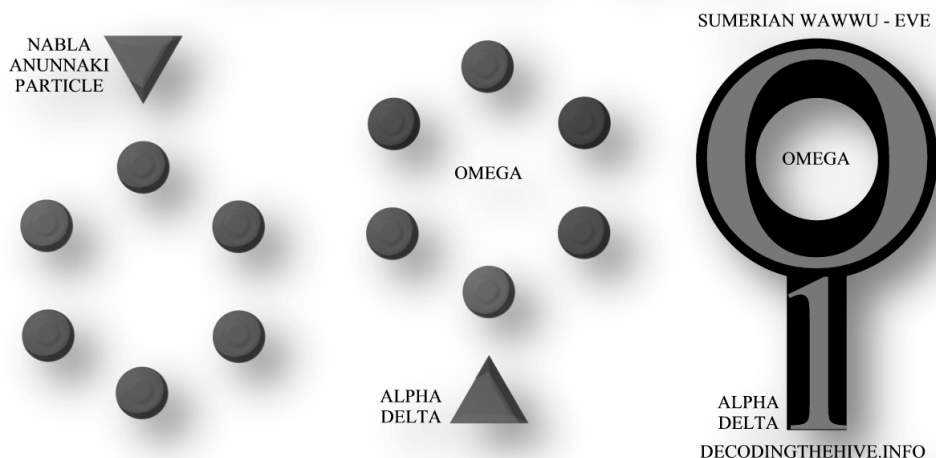

Decoding The Hive

creation of gravity, light, time and the god particle

IOTA = ION

Ion, the mainstream name for **Aniline Krystal Seed Atom** is synonymous with IOTA, as in the *smallest measurement* (within the common-man lexicon). While scientific *smallest measurement* is **FEM**tometres, the great unwashed are given a different measurement as the *smallest*. The **ion** **iota** carries an amazing anomaly in phonology (speaking) when translated to grapheme (writing) as you will see. This *tiniest* within the alphabet comes in the form of a **falling diphthong**, or a symbol under a letter in the form of an **I** as in **ion** and **iota**. And make a mental note now that the word “diphthong” itself that identifies god within a god-letter is spelled with an utterly silent **h** in the middle, as any word *referring* to the fake gods must have the hidden **h**, which is the **Y** (Y) shown above reversed and inverted. This is a word that is not the name of god, but refers **to** god. While we might think diphthongs have something to do with intonation, it absolutely *does not* (as explained on Wikipedia under **Greek diacritics**). It has to do with the specific delineation of that letter representing more than just the letter, it is literally representative of **deification**. The examples given here by Wikipedia just so happen to be entirely **ultra-god letters** I have been talking about in their **highest possible forms**, each one carrying the **I** for iota (**Lepton ion**) which stands for the number **1 Elohim**, which is the **fourth line** symbol: **⚡** which was the “1” that was added to the **three lines**: **⚡** of **Eve**. Every single letter example given under this god-classification for iota are made up with the **three lines of Eve**:

Wiki: Iota;

*Iota participated as the second element in falling diphthongs, with both long and short vowels as the first element. Where the first element was long, the iota was lost in pronunciation at an early date, and was written in polytonic orthography as **iota** subscript, in other words as a very small *i* under the main vowel. Examples include **Α α Η η Ω ω**.”*

As for the letter **I** in **ion** and **iota**, it is the symbol now used for the electricity danger lightning bolt from **early Greek**: **⚡** that now looks like **I**. Every letter in **Iota** and **Ion** are both spelled using the god-symbol grapheme letters that all have stood for **Wawwu Eve** for many thousands of years, just as the word **Lepton**, another word for **Neptune**. While it is difficult or impossible to clearly see exactly what this symbol’s shape is when it is so very small, it can be enlarged as shown here, revealing that the iota **I** is actually an **L** as in **Lepton**, delineating the **w** for **Wawwu**, both upper and lowercase **A** as in **Alpha Anunnaki**, the hidden **H** and the **n** which are the same symbols for hydrogen/Hathor Mary and of course, the ultra-royal symbol of the **Omega**:



Decoding The Hive

creation of gravity, light, time and the god particle

THE IONIA EVE LEPTON

In the same group of islands in Greece we spoke of earlier where the **Masons** got their name from the **Messenians** who deify **Poseidon/Saturn/Zeus Ψ** that now serve as the standing army of the **Knights Templars** for the **Catholic church**, the ancient city of **Ionia** issued a **Lepton** coin in recent times in the 1800's. Leptons (**Neptunes**) are the smallest denomination of any given currency, just like **leptons** are the smallest denomination (invisible) of electricity-quotient of the electromagnetic spectrum, making them **Femtometers** which means smallest. The **Command Code** symbols on this coin are overwhelming. We won't get into all the symbols that are present that are tied into the **Eve Program** here, as that will be covered more in the **S@t@in Cϕphϑ** edition of this ongoing report. But the significance of the image on the right cannot be overlooked while dealing with the power of activated neutrino ions that carry **all** the energy used in this dimension:



On the back of the coin you can see that Triton/Poseidon/Neptune, the god of the sea is actually **female** (as Nammu/Wawwu/Eve). The program for the enslavement of the hybrids created under the **Wawwu Program** had to have been renamed sometime much later than when the project began 242,000 years ago with the creation of the Adam-Kadmon **Hyksos** human/Sumerian hybrids she had a hand in bringing into creation. Likely around 7 B.C. at the birth of the **Hyksos savior** Jeshewua Ahumbara Melchizedek now called **Jesus** (Marduk/Zeus/Poseidon/Saturn). At this time, though the Program itself never changed, the **Eve Program** would put a new/updated name and face on the goddess that would carry forward every name ever associated with the “gods” (different graphemes, same person) of life, birth and water. Her **Primal Signet** would remain the **Delta V** (for obvious reasons), but now the symbols for her new name would be included along with the female herself in “human” form in this updated **Fire Letter Keylon** to bring forward the previous **Wawwu Program** spells. The multi-cross you see her sitting on above (shown in circular form and carrying **12 Delta Vs** inside, was likely the very first original **Primal Command Signet** behind the **Wawwu Program**) would need to be included of course,

Decoding The Hive

creation of gravity, light, time and the god particle

and adding an additional V for a **perfect “13” count** above in the new Fire Letter along with the head of Triton’s spear included to that to reinforce the fact that it is sea water that she specifically garners her powers from. All depicted here in incredibly hidden cipher:



THE EVE (WAWWU) PROGRAM

Of course the creation of the coin that included both the **Eve Program** on the back and the **FIRE LETTER ELOHIM G.O.D. Program** on the front would have entered under the **Magic Money Program** subset if you were making a multilevel list.

By now you should be able to conclude in extremely complex scientific terms that the neutrino **Ve** is actually **eVe** and a multidimensional wave force that carries the **ELECTRICITY** held within the **SALT** of Deuterium ions, and the **V** is the **original Anunnaki Particle neutrino Lepton ion** that activates the **Krystal Seed Atom Aniline Omega (O) Oxygen (life) and Hydrogen (energy and antigravity) H** that is the hidden **h** in all of the most significant god titles

Decoding The Hive

creation of gravity, light, time and the god particle

within the **G.O.D. Program** that stands for the **Holy Ghost**. And while this seems far beyond complex enough, we are still not done with the V and E in electricity which stands for the androgynous god of the aetheric Elohim and their earth-level representative Eve which will be expanded on a bit later. **V** is the closed-Vulva **Virgin Mother Mary ion in stasis** scientifically called **Alpha** and **E** is the *activated ion Mother Eve giving birth* called **Omega**, going under the scientific cipher title **Aniline**. **Ion** is not ONLY god, but it is clearly the **alpha and the omega** and always has been since the invader's arrival 550 million years ago. Since it has been shown to you since the dawn of this current age in the story of the Red King and White Queen by the being considered the most spiritually and intellectually advanced to ever walk the earth, Thoth/Hermes, author of 20,000 manuscripts covering the embodiment of the highest knowledge brought down to earth from the gods themselves both symbolically and elaborately detailed within the terms of science, spirituality and mathematics, they can claim that "they told you" and "you didn't listen" which absolves them from the **karma** retribution for your enslavement (they think).

It might sound like a game, but karma is extremely real and extremely serious. The disclosure within all music, films, written and by the spoken word by your captors has to do with karma, the absurdly powerful force of the aether collective that exacts balance at all times within the hologram. If they can claim that you were shown what was really going on, then the aether is forced to allow them to continue the charade because it was your "free-will choice" to continue to bow down before the gods of Ba'al (Elohim). (This will be explained in great detail in the chapters later on **HOW GOD IS CREATED**.)

The reason why the **sun** has been the focal-point of continual deification since time immemorial is because it is the portal of neutrinos (electricity) and ions (oxygen and hydrogen crystals) to this plane that collect in the oil below the mantel, transferred to the crystals in Deuterium water and then delivered to the surface by that liquid silicate energy that recharges the physical body in the form of electricity that raises your frequency and allows the initiate higher dimensional connection. Like a Baghdad battery that produces electricity just by adding salt or opening the lid and exposing that water to sunlight, you are able to physically raise your electromagnetic quotient simply by allowing the neutrinos to recharge the ions held in the liquid silicate crystal of your blood by bringing them in through your eyes (eye lids closed during mid-day, eyes open in early morning and evening) and into the neural network of your Avatar that recharges your plasma body. That's how the "gods" were able to raise their electrical signature in their body to then "ignite" crystals (begin the flow of electromagnetic energy) that formed their caduceus staffs, unlocking the power of those crystals to then *speak to* trillions of energy-infused crystals held within every pixel across every centimeter of the spacetime fabric (like **YELLING REALLY LOUDLY**, energetically speaking).

Before you can speak to crystals to *do something*, you must first be able to raise your own vibration to their frequency channel. The caduceus staff was the *light switch* that turned on the power of lightning and thunder and would not work unless the person holding the staff had energized their own body to begin that chain reaction that carried their intent across the aether. For real.

Decoding The Hive

creation of gravity, light, time and the god particle

The word aether itself has also been commandeered by the same being who commandeered so many of the other titles and symbols we have been covering, Marduk Satain (Pan) who's common name was EA, the first two letters of the way we now spell aether. EA, using the same scientific symbols in Lattice Theory (Triton/Nabla) is $\in V(\in)$.

THE FLIGHT OF PETER PAN

This fission/fusion reaction within the **Partiki Cell** (the first power of the **Keylon Grid** that begins manifesting a god's intent) creates what you can see (matter), created by the particles from the shadow (anti-matter) of duality in an image where there is a complete lack of light. Light (photon particles) is used to create the hologram of matter by using the energy of the anti-matter below to *light up the pixels above*.

*When matter (light) is projected, it always casts a shadow as you know, but in reality, the shadow is literally showing you where that hologram came from, because now there is **no light** below it in the body of the shadow.*

When **light** is merely visible, such as in a **flame**, it **does not** cast a shadow because it is in its **natural holographic state** and is not cancelling out the particles below it in order to manifest a physical body, it is remaining **pure light**, which is in science-terms the Higgs Boson god particle. Flashlights, spotlights, headlights, lasers do NOT cast a shadow due to this fact. They are not **manifesting** anything corporeal (physical, material), therefore they are not using earth's **manifest energy** in order for it to appear.

Earth's physical body is a **crystal** that carries energy. Your plasma field comes to this dimension and then tells the crystal in earth's body to *do things* such as allow you to *walk*. When you are close to that body (soil), you then have **her power** to broadcast your hologram which appears like a shadow now where it came from (let's say the sidewalk), and now all that energy that used to appear as *soil* appears as your physical body above where you are supposed to be *walking*. If you could resonate with the same frequency that water does (which is MUCH higher frequency than your plasma field), then you would be able to *walk on water* just as easily as *walking on the ground*. The only difference between dirt and water is the frequency by which the crystals operate. Your plasma field frequency is harmonically in resonance with soil, but it is lower than the resonance of water, so therefore your song is unable to ignite the energy in the water in order to *cast your shadow*, and project your material body (hologram) above.

Peter Pan kept trying to sew his shadow back to his feet because he was trying to manifest within this playing field and that cannot be done without the body being projected from the energy that was once dirt (or whatever you are supposedly standing on) that is now totally void of light, as the shadow pixels of the spacetime fabric are the pixels **broadcasting the hologram upward** to create the 3D illusion. The sun **does not** cast shadows, the shadow itself is **casting** the hologram you think is your body.

*The electric signature of the human on the planet today has been **vastly** reduced by the **Anunnaki Particle** ▼ that disconnects one of the points in the Hexagram pattern, thereby*

Decoding The Hive

creation of gravity, light, time and the god particle

lowering the **AMPS**, or the **VOLUME** (think radio speakers) by which you are able to “tell your story” to the aether in order for the aether to carry that story (which is your song of intent) from one aether particle to the next. Commanding the aether has to do with how **LOUDLY YOU ARE ABLE TO SHOUT**. Past deities were able to use crystals to amp-up their **VOLUME** in order to **tell more** aether particles what the song is, therefore they were able to manifest **BIG THINGS** such as lightning bolts, or moving mountains. Right now, your song you are singing is able to speak to aether particles around you just enough for them to project the image of your body walking or running, but the pixel crystals projecting “the dirt below your feet” are connected to your hologram, or close to it. The further away you get from those “material” pixels, the less they are able to **hear your song**, thus you can no longer fly. If you were merely able to scream down to those aether pixels below you, you would be able to “cast your shadow” (project your hologram from) those material pixels below you from a point higher than where your feet are actually touching down. Peter Pan’s **sewing needle and thread** to sew back on his shadow analogy was to reveal that he had to use **devices** to expand his broadcast beacon louder in order to enable him to fly **above** those pixels.

His hip-and-waist connection with Tinkerbell who carried “fairy dust” is legendary in that it allowed **WENDY** to fly “in the **WIND**”. This would have to be **Carbon-7 high frequency crystals** that are now flooding into earth’s plane to elevate the frequency of all of mankind during the **Stellar Activation Cycle**, preparing humanity to come into frequency alignment for the next **higher octave** (**LOUDER**) of existence. Carbon 7 is likened to “fairy dust” (the way it was explained to me) and was present in days of old covering the bodies of all those who had organically passed through a stargate from a higher dimension when visiting this one (by virtue of their own very high frequency from their Angelic Human DNA). It appeared as a blue powder that coated their skin once they arrived in this frequency spectrum. Invader races figured out immediately that if they hung around stargates and waited for someone to come through, they could kill that person, scrape off that powder and use it to elevate their own frequency which allowed them to go back through that stargate to invade higher dimensions. You can think of Carbon 7 like millions of tiny batteries that powered the plasma field around a human body high enough to **YELL REALLY LOUD** to the aether to carry out their command, which could be used to transmute to higher dimension, fly, move a mountain, or whatever it was they were intending.

This is why the beings from ancient past were able to set themselves up as gods through the power of the ocean, because harnessing the higher frequency powers of the Aniline crystals found in water allowed them to transcend the simple traversing of land, which made them appear as all-powerful gods. Mercury, also known as **Hermes**, also known as **Pan** and **Marduk** was able to fly faster than all the other gods, now depicted by the wings on his head and feet:

Decoding The Hive

creation of gravity, light, time and the god particle



Exactly like the man behind the curtain in the land of OZ who was using megaphones and smoke and fire and holograms to strike ultimate fear into the hearts of all who came before him for courage, a brain, a heart, or to get back to reality where Dorothy came from, he used props. In Mercury/Hermes' case, his was his caduceus staff made entirely out of crystals that literally held together in the form of the frequency he desired. By themselves. When he chose a different command, the crystals would literally reassemble themselves in a different pattern with the blue crystal before the red, etc, to arrange their DNA commands. If you grabbed the same controls behind the curtain that he used, you too would be just as powerful as the great and terrible OZ. And "terrible" always accompanies "great" down through history because instilling fear in you so you don't have the courage to pull back the curtain is their ONLY WAY to keep you from learning what you are right now. The power of Aniline crystals from the ocean floor would make anyone the ruler of the planet earth and the heavens above. Think Posiedon and Thor.

*Prominent German Jesuit Polymathetician Athanasius Kircher, a famous 17th century scholar and author of 40 highly regarded scientific books on **music, optics, magnetism, geology, and linguistics** is best known for his **Oedipus Aegyptiacus** (1652-54), which was a vast study of **Egyptology** and comparative religion. He was famous for his knowledge of **automata** and is reported to have built a **perpetual motion machine** and a **talking head** that could **answer the questions** it was is asked. That a **Polymath** expert was also a **legendary** authority on **music, optics, magnetism and linguistics** and would know how to build a **perpetual motion device** and a **talking head** that could answer any question asked of it was also a **Jesuit** is hardly startling, as he was a student of **Hermetic Alchemy**.*

*Athanius also published images of a **hydraulic machine** that duplicated Jesus Christ **walking on water**. How was he able to do that? Would it surprise you now to learn that*

Decoding The Hive

creation of gravity, light, time and the god particle

*he used a powerful magnet placed on the chest of **PETER** who was sinking in the water while walking out to join him when he had begun to “lose faith” that he could also walk on water? And by Christ’s outstretched hands (placing Kryst’s command **LOUD** frequency **VOICE** within the proximity of the **MAGNET**) that then **amplified** that **electromagnetic energy** into **PETER** who was then able to rise again. Athanius’ mechanical emulation of Jesus’ higher frequency was imparted to Peter by using Kryst’s broadcast **AMPLITUDE** that spoke to the magnet which then amplified the harmonic frequency that physically surrounded Peter who was then able to tell the aether particles within the spacetime fabric to project his hologram above the water level. It has always been through the use of crystals (which are the power source of every magnet on earth) that the “gods” were able to mechanically emulate the ultra-high frequency that the DNA particles within Kryst’s perfectly aligned 12-Strand genetic code that allowed him to “move mountains”. It has always been about **electromagnetic power** that serves as the **broadcast medium** between a mortal man on this plane being able to transcend the limitations of the lower frequency that the Anunnaki Particle creates within human hybrid bodies that has allowed these gods to set themselves up as deities from the beginning.*

*There was an actual Kryst who did **organically** resonate in ultra-high electromagnetic energy that was here 2000 years ago, and he was one of the **Guardian Alliance** here to do exactly what we are doing today, teaching humans how to exit this plane if you are merely willing to embrace the fact that we are all one being and harming a fellowman only leads to more of this same reality. When you learn to stop judging down your fellow fractals of god, your particle-spin within your DNA will **RAISE** higher, allowing your **VOICE** to reach the eather directly without the mechanical, artificial manipulation of the aether.*

*The fact that “**Peter**” was **Jesheua Sananda Melchizedek’s** (Kryst’s) side-kick should tell you something, because it was **Jeshewua Ahumbra Melchizedek** who came to this planet at the same time as Sananda to work together under the **Co-Evolution BioRegenesis Treaty of Palaidor** to help both the **Angelic Humans** and the **Adam and Eve Hyksos hybrids** to ascend. These two stories of Sananda and Ahumbra have been woven together in modern religious texts in order to hide the fact that there were two different “saviors” of humans and hybrids, because the invader races don’t want people aware of the fact there is such a thing as “humans” and then there is such a thing as “hybrid humans”. **12th level Avatar Sananda’s** electronic signature was vastly higher than that of the **9th level Avatar Ahumbra**, and that allowed him to command the aether in a way Ahumbra was unable to do. It has been reported by Pleiadean channels that Ahumbra was actually Marduk who manifested as the Hyksos Adam and Eve hybrid’s savior Jesus. He was posing under the guise of belonging to the **Emerald Covenant** for this extremely important reseeding of the highly deteriorated genetics of both humans and Hyksos hybrids, just so they were able to trick the Guardian Alliance into allowing the Elohim to bring in a totally assembled **9th level Hyksos** (Marduk/Ahumbra) DNA back on the planet to help the invader races continue their hybridization agenda. Immediately after the Guardians educated Ahumbra on how to assist Sananda on how to use the ascension stargate below Cheops in Giza, he reentered the **Luciferian Covenant** and*

Decoding The Hive

creation of gravity, light, time and the god particle

abandoned the **Co-Evolution BioRegenesis Treaty**. Ahumbra's name now in biblical texts would have to have been changed now to **Peter**, for the simple fact that the goat-man (half-human, half-animal) **Pan** who lead the children away with his magical flute was later turned into **Peter Pan** as the boy (who refused to grow up, exactly as **Marduk** has done) who could fly. Mercury, another name for **Hermes**, was famous for his magical **Shepard's pipe** that looked exactly like **Pan's flute**.

Pan's Flute was illustrated together with *Pan's labyrinth* in this early writing shown below. The labyrinth was a mystical land where you could become trapped, not able to find your way out. And like the yellow brick road that began in the center of a spiral, it led you into the wilderness:



TRIFORCE OF THE DRAGON

Pan was the ruler of the pre-deluvian lost-Continent of **Pan**, part of which is now known as the remainder of the **Panic** or **children of Pan**. **Marduk** took over the eastern areas now known of as the **Orient**, many, many thousands of years ago. The northern end of the continent that remained above water after the flood is now **Zha-PAN** and the word **Nippon** itself literally means **North Pan**. The rest of that continent will never rise again, meaning it is literally **Never Land**. The **SIGNET** of the land of Pan was sketched from the **Benten-Do Temple** on a small island in the Shinobazu Pond in Ueno Park, **Tokyo, Japan**. It is called the **Triforce Scales of the Dragon** where a **Trinity** of tetrahedrons formed a forth which just so happens to be the exact same image of the **Anunnaki Particle** that disconnected humanity from its actual reality at the arrival of the animal invaders. It is surrounded by the **waves of the ocean** that gave **Peter Pan Jesus Christ Marduk** his power:

Decoding The Hive

creation of gravity, light, time and the god particle

PAN'S TRIFORCE SCALES OF THE DRAGON SIGNET



ANGELS CAN FLY

The power of the **Signet** coupled to the power of **crystals** embedded directly into it combine both the power of the command as well as the sparks created by the crystals themselves to amplify the voice of the god who is casting the intent. **Criss Angel**, who I have witnessed in person, is not a slight-of-hand magician. He is the real deal. And the forces he is calling on for his powers are the **Nanites** that rule over the Anunnaki that hand them the science to manifest greater energies to call upon the aether. The Nanites masquerade as “satan”, but really Marduk Satain is just one of their pawns who has no actual powers of his own. Standing before a Sentient being who has all 12-Strands of their DNA assembled, he would possess literally zero ability to impose his will over them at all. This was witnessed by the fact that the “demons” confronted by Jesheua instantly begged to be cast into the swine which were then drown in the sea, because the organic power of a fully educated Angelic Human couldn’t even begin to be challenged by the Djin who possess no actual power of their own.

Angel, obviously a **title** that has now been turned into a **Command Code**, was given in return for his blind allegiance to the dark forces and into his own **Command Signet** to wear, the same

Decoding The Hive

creation of gravity, light, time and the god particle

“powerful magnets” that **Athanius** used to reproduce Peter’s mechanical elevation to rise back up out of the water, was the exact same power that **Aaron** wore as his breast plate filled with crystals that he wore over his **heart**. This is the same place Angel wears his **Command Signet**, which is **amplifying** the **frequency** of the **heart’s broadcast**, into the aether surrounding him which tells the spacetime fabric pixels what his intent is:



Crystals and **magnets** as well as **sounds** can all mechanically amplify the vibration of the being who is seeking to command the aether. It was **Pan’s flute** that broadcasted the **song** of Marduk’s **intent** that was able to create a mystical reality where he was able to lead the children away from their parents. His **flute** was **singing the frequency in both tone and pulsation** that spoke to the **energy** of **Aniline crystals** that would power his **plasma body** with a **LOUD** enough **VOICE** that his physical body was then able to speak to the spacetime fabric to tell it exactly what he wanted to see with his eyes. Once he saw that reality, it was then cast into actual reality around him, and then the children (**Panics**) could see it too.

And now you have had a real taste of the **S@t@in Cϕphɛr**, but there is more to come in order to explain to you exactly what the **god particle** really is.

CHAPTER 26

THE NEUTRINO CΑΔΣ: SCIENCE SYMBOLS



By now you understand that science is deliberately using secret encrypted definitions and hieroglyphics-codified Sumerian symbols within their ciphers to block mankind from ever understanding how the holographic reality actually works on a scientific level while assigning symbols and titles to the most powerful particles in existence to perform under the **Command Signets** of your eternal captors. While I was not educated directly by the Illuminati on **Occult Alchemy** (as I am not a **Hermetic Initiate of the Golden Dawn**), I have been educated on what it is the World Management Team are so fervently sequestering from the public. I can assure you as well, that the deception has been so clever that the scientists themselves, who know the truth

Decoding The Hive

creation of gravity, light, time and the god particle

about the Krystal Seed Atom, do not understand anything about how it all fits together, because of **compartmentalization** of all facets of the big picture. While astrophysicists may know as a matter of science-fact that the sun does not produce heat or light, they will have no idea that the scientific symbols and terminologies regarding particle physics weave into a totally different image than they are allowed to understand. Indeed, independent **Secret Space Program** whistleblowers uniformly and consistently report over and over that their division was compartmentalized to the point that it defies human comprehension.

To build a time craft, you may have 100 different contractors working on isolated components within dozens of above-top-secret clearance levels higher than the president of the United States which makes it impossible for even the uber-geniuses to ever imagine how their component makes that craft function. They may know how to produce an ionic converter, but how people are supposed to climb inside of that craft that has no door escapes them just as much as it escapes you. Much if not most of the time, Frank and Jim who eat lunch together every day, each one working for different contractors, will spend months or years secretly developing the exact same ion-converter to power the temporal back-flow limiter and never share a single word about what they have developed because they would certainly lose their jobs if not their life for discussing their experiments even in ciphered terms. This might cost 100x as much to build the craft and increase development time by an additional 5 years, but that means nothing when secrecy is the only parameter. The military are not the only ones who use this system where you might order your gear motor that powers your new patented Whatsit from one company, your tubes and wires from another, the shell from another, etc. which keeps any one company from producing your invention in China where patent rights are like air and anyone who can breathe it in has full reign over how much they will plagiarize your product. But the military are the only ones who take that compartmentalization to such an egregious extreme that it defies all logic. Because scientific secrecy is the one god that rules all others. If a contractor accidentally learns how his flux capacitor even attaches to the next component in a craft with 500,000 different compartments, he won't be fired; he or a family member will be suicided immediately preventing him from breathing a word about it to anyone else.

The names for breakthroughs such as Newton's gravity or for the discovery of voltage may be reported to you as having been the last name of someone or that scientist had branded it entirely from their own personal flight of fancy, but this is fantasy. Geniuses from a certain bloodline with a first or last name that fits perfectly to that field are given the information about that compartmentalized transition, process, particle etc. and then told exactly how to name it and which symbol to assign to it, based on a hierarchy of technological architecture handed down to humankind from millions or billions of years predating this "discovery" and the reasons for naming that element with those precise phonemes and assigning certain insignias to it are anything but random, as they are mathematical codes that are part of an equation as delicate as genetic splicing or optical surgery. Anyone imagining that the **Hermetic Alchemist Freemason** who placed the law of gravity into the record books' first name was accidentally spelled with two back-to-back letter As doesn't understand how bloodlines are tracked for many thousands of years and when certain personalities reincarnate, they are handed titles for their names that carry forward their provenance that will be connected to a desired fate into the new life they will lead. Newton wasn't just inducted under the royal title of **Sir** for no reason, and he wasn't just a

Decoding The Hive

creation of gravity, light, time and the god particle

Freemason; Cambridge University's Grand Lodge of the Freemasons number 1161 is literally named after him.

To have the illusion that a science geek who has dedicated every waking minute of his life leading up to discovering a brand-new type of neutrino also knows the nuances of the past 10 thousand years of Sumerian, Greek and Roman mythological personalities and their multi-layered provenances such as that of **Tau** clearly enough to assign the name and signet of that new particle breakthrough whose actions mirror the story of unthinkably ancient lives of almost unknown historical players is to imagine that scientists have 500 hours in their days to learn the highest levels of advanced particle physics and also everything about history at the same time. These symbols, signets, numbers and letters were created by the Anunnaki for their language and sciences over hundreds of millions of years. You aren't inventing *anything. Ever.* You are parroting what they tell you to report and not one single thing extra.

So how do I know this is a certainty? Because I was an inventor who was obsessed with making things that had never existed before; fully convinced that once my breakthrough entered into the annals of scientific history that I would be heralded as the boy-genius with no formal education who did the impossible with nothing but dental floss and a screwdriver. And while I have multiple patents that came from the wooden benches of my garage and self-styled laboratory that changed history for certain industries, I was also told directly that there is no such thing as anything that hasn't been invented at least a hundred, thousand or million times before and everything I was doing was only reinventing the wheel. Particle physicists aren't historians, they are inventors, otherwise they would be called historians (news reporters). If you would like to see how the evil rapist Greek Tau is like the overpowering lepton tau electron you might read up on that to find out that he was the number 7 and correlated with satan himself. Why a sun-rays gamma particle might be named after someone from history analogous to the being who claims to be in charge of the sun's rays and given the signet of the hidden X (t) Trinity carried by the god-particle that gives birth to all material matter and is considered the **secret graviton** is surely just a random coincidence and nothing of interest, right? And the fact that **Martin Lewis Perl**, the **Russian Jewish** scientist that won the Nobel Prize for discovering and naming the **lepton tau** studied **sodium atoms** (code word for **salt crystal Aniline**) under the personal tutelage of **Jewish** Nobel laureate **Isidor Isaac Rabi** (obviously named after **Isaac Newton**, but more than likely was just a reincarnation of the exact same man) who was responsible for **founding CERN** and **Chief Science advisor to 32 degree mason** US President Truman is mere coincidence as well.

There are no coincidences when it comes to how this planet is managed and ruled which is dictated from the very top to Hermetically seal higher truth from the great unwashed. You will be the first ones to see how the modern-day scribes of the Sumerians have interlaced every nuance of particle science with the codes of the **S@t@in Cϣphɛr**.

The way that ancient symbols were used to deify the gods that are now used very precisely within modern science and their direct correlations is an extremely complex subject that represents many hundreds of hours of learning the cultures, religions, traditions and intonations of civilizations around the world and down through eons of time, as well as learning the most deliberately ciphered language of science and

Decoding The Hive

creation of gravity, light, time and the god particle

mathematics one can imagine in order to illustrate the cryptography involved in secreting away from mankind how the very ancient rulers of Sumer-Ur Babylon are still the rulers of all higher education today. It would be effectively impossible for my explanation of how they fit together to simply read like a shopping list. While I have given you the connections and clarified the evidences to the best of my ability on a highly-redundant and scientific level, simply repeating myself will never suffice to make this easy to follow because of the extreme level of detail that has been applied to keep the public from ever understanding the code. So I will offer you a reference chart that encompasses the most complete historical archeological literary synopsis I have for you to use in researching just how all these symbols continually were deciphered from civilization to civilization to stand for very different things in everyday language, but always referred back within this hyper-complex cryptography to the gods which were actually quantum particles all along, not actual deities.

Do not think that the following pages will be simple to read and understand, because even though I know what all these very specific connections really mean, it is still incredibly demanding to follow. This is why I have put into words how they concisely intercorrelate in multiple different ways for you. I know it is redundant and I know it is confusing, but we are literally piecing together thousands of languages and cultures who each one had been uniquely tricked using this system and it factually did work for many thousands of years, so expect to be challenged. This chart is by no means accurate or complete; it is merely the most comprehensive of many, many charts I have had to use in order to connect the dots. In real-world terms, the coincidences between the pictograph, grapheme and hieroglyphic symbols below precisely connecting to the actual functions of these quantum particles as applied in science merely occurring by happenstance would be statistically impossible to calculate, as the zeros would run off the computer screen. And maybe none of this is important to you to understand, but this report must not only provide the evidence to the average reader how gravity and light are created, but also to the scientific community who will be passionately opposed to this revelation because it will disprove virtually every truth they have paid with entire lifetimes to learn. And in the end, my intent is to not only disprove most all of modern science and math, but to explain exactly what the god particle really is, what it looks like and how that can be factually proven through the most sophisticated experiments available.

Decoding The Hive

creation of gravity, light, time and the god particle

Egyptian 3000 BC		proto-Sinaitic 1900 BC		Phoenician 1050 BC		Hebrew		Greek 800-600 BC			Etruscan		Latin	
means	symbol	symbol	name	means	symbol	name	means	early classic	modern	name	symbol	early	modern	
ox			/ʾ/ 'alep	ox		/ʾ/ 'aleph	ox	א	Α α	/a/	alpha	Α	A a	
house			/b/ bayit	house		/b/ beth	house	ב	Β β	/b/	beta	Β	B b	
throw			/g/ gimel	throw		/g/ gimel	throw	ג	Γ γ	/g/	gamma	Γ	G g	
stick			/d/ dalet	stick		/d/ dalet	stick	ד	Δ δ	/d/	delta	Δ	D d	
door			/h/ he	door		/h/ he	door	ה	Ε ε	/e/	epsilon	Ε	E e	
(hieratic)			/w/ wawwu			/w/ waw		ו	Ϝ ϝ	/w/	digamma	Ϝ	TUV	
			/z/ zain			/z/ zayin	sword?	ז	Ζ ζ	/dz, sd, zd/	zeta	Ζ	Z z	
wick			/h/ heth			/ch/ heth		ח	Η η	/h/	eta	Η	H h	
arm, (to push away)			/y/ yadu	fist?		/y/ yodh	hand	י	Θ θ	/th/	theta	Θ	I i	
			/k/ kappu			/k/ kaph	hand?	כ	Κ κ	/k/	kappa	Κ	K k	
			/l/ lamdu	ox goad		/l/ lamadh		ל	Λ λ	/l/	lamda	Λ	L l	
water			/m/ mayim	water		/m/ mem	water	מ	Μ μ	/m/	mu	Μ	M m	
horned			/n/ nahas	snake		/n/ nun	fish?	נ	Ν ν	/n/	nu	Ν	N n	
viper			/ʾ/ enu	eye		/ʾ/ 'ayin	eye	ע	Ο ο	/o/	o mikron	Ο	O o	
eye			/p/ pe	mouth?		/p/ pe		פ	Π π	/p/	pi	Π	P p	
finger			/s/ san			/ts/ sade		צ		/s/	san	Ϻ		
tooth			/q/ qoppa	head		/q/ qoph	monkey	ק		/q/	qoppa	Ϟ	Q q	
(elephant's tusk)			/r/ rashu	head		/r/ resh	head	ר	Ρ ρ	/r/	rho	Ρ	R r	
			/sh/ shin			/sh/ shin	tooth?	ש	Σ σ ς	/s/	sigma	Σ	S s	
perfect			/t/ tawwu	cross		/t/ taw	mark?	ת	Τ τ	/t/	tau	Τ	T t	
			? u psilon			? u psilon		י	Υ υ	/u/	u psilon	Υ	U u	
			? chi			? chi				/kh/	chi	ϸ	X x	
			? psi			? psi				/ps/	psi	Ϻ	Y y	
			? omega			? omega				/o/	omega	Ω	XYZ	

SAL(T) = NABLA = DELTA = ALPHA

Using the symbols grid shown here in many insertions along with many others not shown, each of which were collated by thousands of linguistic archaeologists across modern civilization, here is a synopsis of what we have just covered. Keep in mind these transliterators do NOT understand how Keylon Signets work, and have overlooked what the symbols really meant. They merely understand how the applications of the symbols have been used from the unwashed-masses applications, not how they were used within the KoHaNiM Priest class of the Sumerians, the scribes who first used literation as Hermetically-sealed cryptography to communicate with fellow gods who ruled over the slaves:

SALT ∇ is now the Anunnaki Particle symbol called **Nabla** ∇, inverted in (D) **DELTA** Δ (**Alpha**) for the *baryon neutron* that turns into the *zero-spin* **O** (omega) scalar-vector **Pi Meson** in the **Delta trinity Triplet state** ∇ which is the **Trinity** and also shown in the Sumerian/Phoenician symbol for **Daleth**. There is a reason why typing the capital letter **D** in Greek symbols prints out a **Daleth/Delta** to represent the god-particle found inside **Deuterium**;

Decoding The Hive

creation of gravity, light, time and the god particle

proto-Sinaitic 1900 BC			Phoenician 1050 BC			Hebrew			Greek 800-600 BC			Etruscan		Latin	
symbol	word	means	symbol	name	means	symbol	name	means	early classic	modern	name	symbol	early	modern	
𐤀	/d/	daleth	door	→ א	/d/	daleth	door	ד	→	Δ δ	/d/	delta	→ (Δ)	Δ Δ	D d

DELTA/ALPHA = THE ALPHA AND THE OMEGA

Also symbolized in the Anunnaki Particle (A) **Alpha** with the scientific symbol literally that of **A** itself, representing the *zero-spin* **O** (omega) in **Delta trinity Triplet state** ∇ (**Alpha**) nucleus of the *helium* particle (that is the nucleus of the *hydrogen* particle and the nucleus of the **Deuterium** particle used at CERN to reveal god particles) made from the Sumerian symbol **Aleph** “Ox”-head symbol that was also used in **Shin-Sigma** (Σ) (also an Ox head) that is today the lightning bolt of **SALT** ⚡ as positive (+) Σ lectricity. While the Daleth/Delta has always been merely **Alpha** Δ , **Shin-Sigma** and has always stood for the god Wawwu/Eve as both **Alpha** and **Omega** now shown hidden in the uppercase **D** Δ (Alpha) *and* lowercase **W** ω (Omega) and now printed out as the **scientific symbol** Σ by pressing **S** in Greek symbols. Even in ultra-ancient times, this would have been a hidden ciphered-symbol to stand for the god Wawwu Signet Ψ the masses knew about which is the actual quantum shape of the **Aniline Krystal Seed Atom** that makes up **Deuterium** D^2 . Keep in mind, that the OX HEAD has always stood for the Bull of Utu (Ba'al), another title for Marduk who incarnated in the form of a bull and the bull children were sacrificed to in Babylon:

Decoding The Hive

creation of gravity, light, time and the god particle

PROTO-SINIATIC ALPHA AND OMEGA

PROTO-SINIATIC OX HEAD
ALEPH-ALPHA LETTER A: Δ

PROTO-SINIATIC SHIN-SIGMA
LETTER S - SCIENCE: Δ Ω

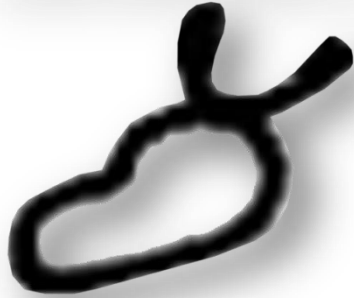

ORIGINAL ALPHA/OMEGA
Δ Ω

ALPHA / OMEGA
Δ Ω

OMEGA
Ω

MODERN OMEGA
(UPPERCASE Ω)

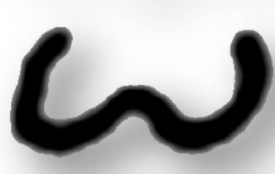

proto-Sinaitic 1900 BC			Phoenician 1050 BC			Hebrew			Greek 800-600 BC			Etruscan		Latin	
symbol	♫	word	means	symbol	♫	name	means	early	classic	modern	♫	name	symbol	early	modern
𐤀	/3/	'alep	ox	𐤁	/3/	'alep	ox	א	→ Δ	Α	/a/	alpha	→ Ϝ	→ Δ	A a
𐤃	/sh/	shin		𐤄	/sh/	shin	tooth?	ש	→ ξ	Σ	/s/	sigma	→ Ϛ	→ Ϛ	S s

DECODINGTHEHIVE.INFO

EVE/WAWWU/SAL(T) = OXYGEN

Deuterium (liquid SALT) boson particles that are the *carrier particles* for **Oxygen** is also symbolized in the positive (+) **O oxygen singlet** particles that have **zero-spin O** (omega) under the symbol of the **Delta trinity Triplet state** ∇ (Alpha) which is the actual shape of a **neutrino Lepton** creating an **Aniline ION (Krystal Seed atom)**: ∇, identical to the first symbol for Eve/Wawwu then called Sal(t): ∇ using both the Greek **Phi** and the Etruscan **Ph scientific symbol φ** for the **potential of water** (now called **F**) which is the symbol for the god Wawwu (Eve) ♀. The same symbol of the Aniline particle found in water ⋯ (Ph which makes the **F** sound is the secret Signet of the Sumerians that went under the title **Phoenician** we will cover a bit more in a minute):

proto-Sinaitic 2000 BC			Phoenician 1100 BC			Hebrew			Greek 800-600 BC			Etruscan		Latin	
symbol	♫	word	means	symbol	♫	name	means	early	classic	modern	♫	name	symbol	early	modern
𐤁	/h/	he		𐤂	/h/	he	wall	ה	→ Ε	Ε	/e/	e epsilon	→ Ϝ	→ Ϝ	E e
♀	/w/	wawwu		𐤃	/v/	waw		ו	→ Φ	Φ	/f/	phi	→ Ϝ	→ Ϝ	F f
								ψ	→ Ψ	Ψ	/ps/	psi			

Decoding The Hive

creation of gravity, light, time and the god particle

EVE/WAWWU = SALT WATER GOD

Deuterium (also known as **liquid crystal** Aniline to science) boson particles that are the carrier particles for Oxygen is also symbolized in the magnetic (-) **O oxygen triplet 3Σ-g** particles with **single (full)-spin O** (omega) under the **Delta trinity Triplet state** ∇ (Alpha) literally using the back-to-back Etruscan **He** 𐌒 (read left-to-right in Sumerian reads **EH EloHim**) and Greek **Sigma** Σ (beginning with the **SALT** Σ Electricity lightning bolt ⚡). The Sumerian symbol **Shin** for **SALT** which was the top of the **Aleph Ox-head's** horns which now stands for **W** as in water 𐎗𐎚𐎛, and in lower-case is literally the Greek lowercase symbol **Omega** ω, so when you type w, it creates the first symbol used to represent **ALPHA** or “**Aleph**”: Ω. But Aleph is merely a distraction from **Shin** now **CALLED SIGMA (Signet)** which is both, **Alpha Δ AND Omega ω**. And since Deuterium (with the **science symbol D** which is now **Delta** in **Greek symbols: Δ**) is the most crystal (salt) heavily-laden water droplet in existence, the scientific symbol **3Σ-g** is literally code for **Salt Water-God**. And since the **w** (Omega) symbol was introduced into the **early Greek** as: √ (the reinvention of **SALT** ∇) to stand for **F** (as in **FEMtometre**), it always stood for the god Wawwu, as it did for Neptune (**Lepton**), god of the **Salt Water** sea Ψ:

proto-Sinaitic 1900 BC			Phoenician 1050 BC			Hebrew			Greek 800-600 BC			Etruscan		Latin	
symbol	word	means	symbol	name	means	early	classic	modern	symbol	name	symbol	early	modern		
𐤀	/h/	he	𐤁	/h/	he	ה	𐤀	𐤁	Ε	Ε ε	/e/	e	𐌒	𐌒	E e
𐤃	/sh/	shin	𐤄	/sh/	shin	ש	𐤃	𐤄	Σ	Σ σ ς	/s/	sigma	𐌒	𐌒	S s
𐤆	/w/	wawwu	𐤇	/w/	waw	ו	𐤆	𐤇			/w/	digamma	𐌒	𐌒	
						ו	ϕ	ϕ		Φ φ	/f/	phi	Φ	Φ	F f
						ψ	ψ	ψ		Ψ ψ	/ps/	psi			

GAMMA RAYS = WAWWU = ELOHIM

Pi/Psi/Phi (each one pronounced effectively the same, with Psi adding a slight S sound to indicate this is the direct intonation of SAL), and all of which stand for **P** which came from the symbol **Wawwu** 𐤆, the much-later symbol for Sal(t). That symbol was shown as **Y** in **Phoenician** times, then as **Phi** φ in **early Greek**. In early **Etruscan**, the symbol **P** was: 𐌒, exactly the same as the **early Greek gamma**: Γ. It is the same symbol for **L Lepton/Neptune** Ψ. Now it is shown as a lowercase **Y** in **modern Greek** and **also** under **P** for the modern **Pi** π, making them the same symbols. **Y**, φ and Ψ all stood for 𐤆 from Phoenician to Greek, making **gamma**, **Phi**, **Psi**, and **Pi** all **exactly the same symbols**, but now broken up in multiple different modern grapheme Latin letters. The **W** for **Wawwu** was shown as: **W** and: 𐌒 in **Phoenician**, **Ψ** and: **E** in **early Greek**, **Σ** in **classic Greek**, **𐌒** in early **Etruscan** and now: **E** in **Latin** making them all the exact same symbols as: **Y**, **1**, **7**, φ and π, all standing for: 𐤆. And each one just a variation to *spell* out the word Elohim:

Decoding The Hive

creation of gravity, light, time and the god particle

proto-Sinaitic 1900 BC			Phoenician 1050 BC			Hebrew			Greek 800-600 BC			Etruscan		Latin	
symbol	word	means	symbol	name	means	early classic	modern	word	name	symbol	early	modern	word	name	
𐤀	/h/	he	𐤁	/h/	he	ה	→	Ε ε	/e/	epsilon	→	Ε ε	E e		
𐤃	/sh/	shin	𐤄	/sh/	shin	ש	→	Σ σ ς	/s/	sigma	→	Σ σ ς	S s		
𐤅	/g/	gimel	𐤆	/g/	gimel	ג	→	Γ γ	/g/	gamma	→	Γ γ	G g		
𐤇	/w/	wawwu	𐤈	/w/	waw	ו	→	Ϝ ϝ	/w/	digamma	→	Ϝ ϝ	F f		
𐤉	/p/		𐤊	/p/	pe	פ	→	Π π	/p/	pi	→	Π π	P p		

Today, the capital **Y** in Greek symbols is the spear of **Neptune**, which is another word for **Lepton: Ψ**. **Gamma rays** is a code for **sun waves** called **Neutrino Lepton Pi Mesons**, **science symbol π**, carrying the **strong force** that strike **Aniline Krystal Seed Atom S** in **water** that create **Ions** that are only then called **atoms**.

Remember, **Pie** to us is something hot with a scoop of ice cream on it, **Pi** to science is an unthinkable **massive** mathematical cryptogram that has turned society completely into children struggling for a single shred of truth in explaining what our eyes actually see. Gimel and Shin may have meant sticks and rocks or teeth to certain civilizations, but to the **KhoHaNiM priests** who ruled over the masses and used the same symbols to communicate in a completely encrypted cipher, they stood for specific **Program Command Signets** that all led back to the Elohim and to their earth-level representatives under the **G.O.D. Program**.

To put it all into perspective, here's another look at Wawwu holding up a dish of water:

Decoding The Hive

creation of gravity, light, time and the god particle

ORIGINAL BABYLONIAN EVE MOTHER OF UNIVERSE AND SUBTERRANEAN COSMIC WATERS

EARLY SUMERIAN
PICTOGRAPH: SAL
MOTHER GODDESS

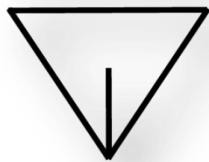

MODERN SYMBOL
FOR I AS IN ION
WATER CRYSTAL



SCIENTIFIC ZERO-SPIN
BOSON/LEPTON
TRIPLET STATE

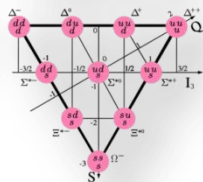

PHOENICIAN
GRAPHEME: WAWWU
LATER SAL SYMBOL



SUMERIAN
SAL MQMMA
Giving Birth



QUANTUM PARTICLE
SHAPE ANILINE
ION SAL(T) CRYSTAL

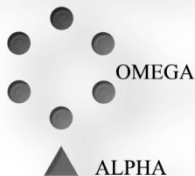

SUMERIAN
STATUE OF FIRST
EVE: WAWWU



DECODINGTHEHIVE.INFO

SCIENCE SYMBOLS SYNOPSIS

- Let me get this straight, if I am following all these breadcrumbs left out in plain sight: the **science symbol V**, the **Greek symbol** for ∇ in voltage which stands for the power behind the science symbol Σ , **Greek symbol** for Alpha-Omega \mathcal{A} and \mathcal{W} Wawwu in electricity that is represented by **Trinity science symbol Δ** typed-out in Greek by using the uppercase **D** as in **DoG** (which is the G in the **now-reversed** word GoD) now *called* Delta and was used in the *very first written form* of communication to stand for **Sumerian Sal(t)** by ∇ in an alphabet that was developed and only used for **business transactions** (now used **only** in **SCIENCE**) not for mainstream communication, which fostered the trading of human **females** (-) represented by **science symbol e** (Σ) which is the current **Greek symbol** for Alpha-Omega \mathcal{A} and \mathcal{W} Wawwu slaves to be used for procreation of the invader race's human hybrids to take over earth from (**A**) Angelic humankind ∇ represents the **science symbol A** Alpha particles which is male **science symbol** + **Etruscan symbol Y** which is the **Greek symbol V** for the **Sumerian symbol** ∇ **proton power science symbol P** the **Greek symbol π** which is another **symbol for Sumerian Alpha \mathcal{A} and \mathcal{W}** that is activated by the true power behind the Higgs Boson's (science symbol HO. The **Egyptian** and **Etruscan symbol** for the letter **H** both stood for **Hydro water**, the carrier of **Hydrogen** and **Oxygen** -HO-. The **O** came from the **original Sumerian symbol for Wawwu** \mathcal{W} enormous energy credited as being the **god particle** that is hidden inside all **multidimensional particles** (non-spin and full 1-spin scalar-vector particles used to laser-map **spacetime fabrics**) in the **Delta trinity**

Decoding The Hive

creation of gravity, light, time and the god particle

Triplet state ∇ known as **science-symbol YZ** which are **both Y and Z** used today by **Greeks** for the **symbol ∇** which is the **Sumerian symbol ∇** for bosons which are created as the only individual quantum non-spin and scalar-vector **science-symbol Y**, **Sumerian symbol ∇** GAMMA rays (cipher-spelled with G as in God) surviving a nuclear explosion which is a sub-Delta **trinity Triplet state** ∇ , non-spin and scalar-vector particle that just so happens to be named a PI MESON with **science symbol π** which is the Greek symbol for the letter **P** that came from the **Sumerian symbol ∇** which is the **Muon (M as in MOM ω)**, the later symbol for the mother ∇ **MAGNETIC science symbol -**) and lightest of ALL hadron particles that decay into **science symbol Σ ∇ and ω ELECTRONS (-)** called **muon neutrinos (-)** that are the **carriers** of the **strong force** of electromagnetic energy delivered to ALL **science symbol \otimes atoms** which just so happens to be a **6 point Hexagram** that are only created naturally in the largest of all energy-releases within cosmic events such as **supernovas** represented with the **science symbol PI π ∇ and ω** , created by splitting **science symbol D Δ ∇** Deuterium liquid **Aniline salt** particles literally named after the highest god known of as AN, called **science symbol H ∇ hydrogen** that have only ONE (as in THE ONE) **science symbol Σ ∇ and ω electron** instead of two or more, that **science symbol O ∇ OXIDIZES ATOMS \otimes** (gives ADAMS the breath of life), and:

- producing a boson is done in a bubble chamber using specifically **science symbol D Δ ∇ Deuterium** that is the heaviest form of liquid sal(t) ∇ water on the planet called **liquid crystal** by science held inside of each pixel of every TV, computer monitor and smart phone to project light they call **Aniline** which is also known as **rocket fuel** and is also known as **ions** which is synonymous for the only usable energy on the planet, **science symbol Aniline**, which just so happens to begin with the name of the highest multidimensional Elohim Suns of Ba'al god in the history of all time, **AN** whose earthly symbol is ∇ then later ∇ , prints out a physical pattern in quantum electron (scientific symbol - ∇ and ω) scanning microscopic **PHO**tographs that were named after **PHO**tons named by the **PHO**enicians who were **Sumerians** who gave us all the alphabets in the world in the form of **PHO**entics and used the primary **THREE (3 Σ)** letters **PHO** that stood for Wawwu in their **name**, in the form of ∇ which is the exact same symbol as ∇ , and the bottom of that pattern is literally a Delta shaped particle Δ which results in producing the most powerful energy particle known to man in the Higgs Boson, carrying the highest **science symbol V ∇ voltage energy**, which secretly stands for **Vector Energy** used in scalar-mapping spacetime fabric pixels, in the lightning bolt ∇ **alt Water** sea, realm of **Neptune Ψ** transliterated to **Lepton** in **Elohim Σ lectricity** – at least unless I missed something

The Higgs Boson is at its fundamental core, the ultimate Alpha particle that is multidimensional and carries energy that is vastly beyond all other particles called the photon that is a Sentient being holding the sub-quantum shape of the power of crystal that once transmutes into 3D electromagnetic energy, takes the physical shape of a crystal while in manifest form and is first seen by human science in the form of the Aniline crystal ∇ . The Alpha particle includes all bosons and all photons, all of which are **scalar-vector** particles, all of which carry standing **magnetic signatures**, or delivering the magnetic portion of electricity that makes up all things

Decoding The Hive

creation of gravity, light, time and the god particle

within our material world and are found in ion water which is then placed into every pixel of every video screen we use in order to act as the light bulbs that both powers and projects the colors that form the shape of all things considered matter, 100% of which are holograms which can only be created by photons. That symbol carries the quantum of every science symbol used by mankind, every symbol used by Hermetic Alchemy and is the essence of the most hidden Program ever used against mankind, the Keylon Template Signets behind 100% of your enslavement. Religion has always been about science to use electromagnetic energy to power their programs that keep you unable to think, interact with the aether or to connect with your higher self because you are tricked into avoiding the neutrinos carried by the sun for fear of cancer, and avoiding salt for fear of heart disease. Science has always been the god of all gods and the exclusive, Hermetically-sealed realm of the Elohim.

SIGNETS OF THE ANNU-ELOHIM

What I have yet to explain in all of this, is the fact that the Anu-Elohim who are ultimately *the* Sentient beings (the first ones taken over and used by the Nanites) behind the enslavement of mankind are known of as **Avians**. They are the ones who make *all things with wings*. Their form of eternal-life **Angelic Krystos** beings came from the Avatars produced in the **Holy Gra-Al Krystal Project** developed by the **Anuhazi**. The Anuhazi were **Lionids** (lions) with wings who created both the **Elohei-Elohim** and the **Anu-Elohim**, both races were the very first of these supreme beings that wielded unlimited energy and eternal life. The **Elohei-Elohim** were **Lionine-humans** (cat people) and the **Anu-Elohim** (your captors) were **Lionids** (lions with wings). The Anu-Elohim went on to make their invader-race *fallen angels* with wings, and made the rest of the birds, bees, etc. on the planet to represent their species. When forming the name of their winged-creations, they reverted back to the shape of the energy that is usable, electromagnetic energy, within this plane which takes the shape of a **V** pattern of the in**V**ader particle (as **literally**, not just symbolically, in **Darth Vader**) that attaches itself to the top of the organic Keylon Sphere which by now you know looks like this: ▼. Together with the **Keylon Sphere**, which by now you know looks like this: ∴, the top of which looks like this: **O**. So they literally started with the two shapes of the “alpha” Δ and the “omega” O.

Using those two symbols, they structured the languages here around those patterns, taking the form of A and V/O as the primary symbols for who they would be in this realm, which would be presented as “gods”. Naturally the name of their eagles, phoenix, doves etc. would be named after them, A.v.i.a.n. **AV** for alpha and omega, **i** for “the one”, followed by **a** once again and **n** which is also the letter **V**, just upside-down. This really just spells out AA1AA. Or in literary terms: **Anunnaki Anunnaki Elohim Anunnaki Anunnaki**.

The A would then be used for symbols that would stand for their creations (birds, etc.) as intoned by humans who spoke with their mouths instead of through telepathy. The V was used for the a, hidden in the g, used for c, h, u, y and w, or basically everything with an opening. Those would be the *etheric* or *multidimensional* god-letters. All the grapheme letters that would follow the original straight lines of the V pattern would then be interlaced with symbols created by the ions in the waters of earth as shown to you previously with the ξ which they chose to stand for the

Decoding The Hive

creation of gravity, light, time and the god particle

modern X. All Xs used today stand for earth-humans who are “dead”, “done”, blocked from higher realms. Then that symbol would be modified to stand for their physical representatives on earth such as Wawwu’s symbols such as ∇ and ♀ which represented the V, but closed-off, as in the O. This is why O has always stood for earth, not just in representing earth’s actual form (an oblate spheroid in the oblong inside of the O, just like the oblong oblate spheroid of the atom), but meaning that earth-level creations were closed-off from leaving this level. Eve/Wawwu was their physical representative on earth, that’s why her Signet symbols were always closed-off, but she would use grapheme letters in her titles that always referred back to the Avian Anu-Elohim to show that they stood together as the god above and the god below as in the father/son religious nonsense that has ensued since their arrival.

The gentle curves of the “earth-bound” symbols such as the ξ, now e in our alphabet are lowercased in Greek symbols and carry gentle slanting to illustrate they are “below”, and the uppercased symbols are vertical and not so floral. In our less filigreed modern letters, you will notice that the *below* symbols used for lowercase “close off” within key letters such as a, b, d, e, g, o, p and q which indicate the symbol for Eve, who will always be within their minds, eVe. As in *here foreVer*. At least as far as they are concerned. This is exactly how they spell their name as shown above with Anunnaki (lower gods) on both sides, sandwiching the Elohim in the middle in AA1AA, or: **Anunnaki Anunnaki Elohim Anunnaki Anunnaki**. And she has factually been bound to this plane since she arrived over ½ billion years ago, something I know of personally. Now you have some frame of reference as to how letters, symbols and Signets operate while spelling out the titles of the gods. A Khan or King will always have the open K in capital (for Qoppa ♀ to indicate “familia” of the Elohim’s fraternity), and then the *below* physical demigod denoted with a closed a or closed g. And even if that lowercase symbol might look like its open, such as with ξ, when enlarged it will always show that the letter is actually secretly closed. We will be getting much deeper into the neutrino/ion patterns and examples of all the closed *below* letters in our alphabet later in the **S@t@in Cyphər** issue. In this perspective, here is the eternal baby-maker slave Eve’s quantum symbol close-up again:

Decoding The Hive

creation of gravity, light, time and the god particle

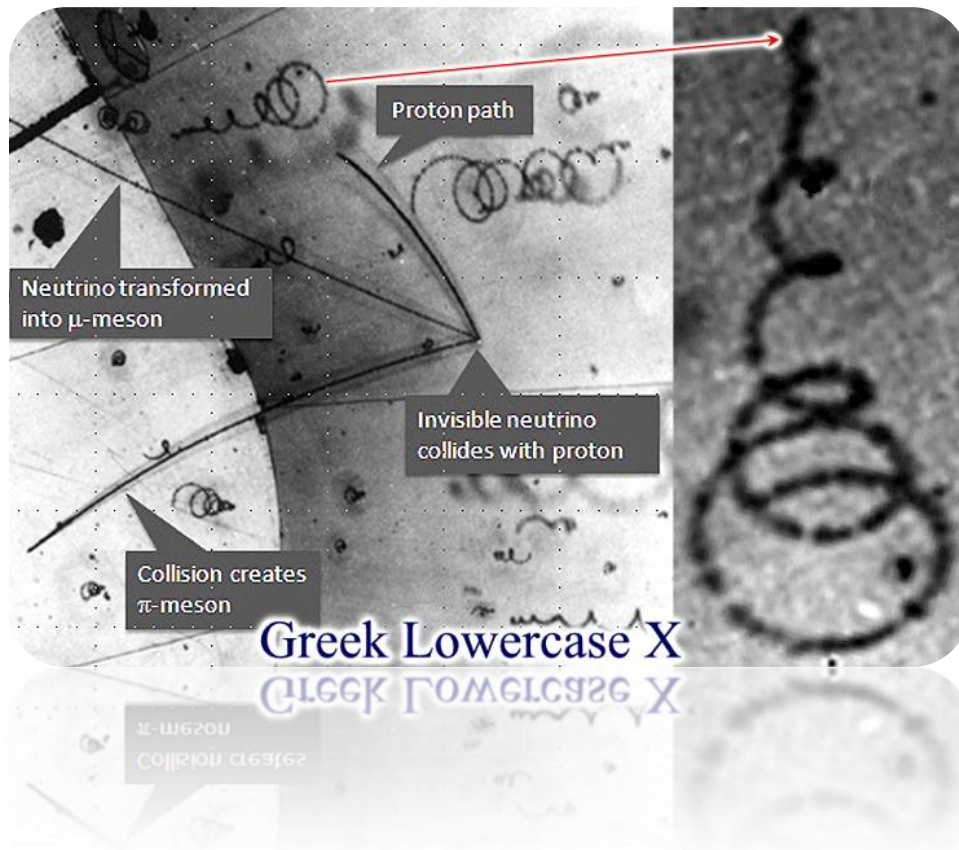

NUMEROLOGY

Obviously, I am showing you where **numerology** comes from, which is secretly ciphered graphemics. Below the mere grapheme symbols were the symbols printed out by MOMMA nature herself that were then **Keylon-coded** to **Command Signets** and those **Signets** became your **letters** and **numbers**. Now when numbers are keyed to letters, you will know how and why. In later reports we will get into what each number stands for regarding the formation of **Command Signets** within the codex of the **S@t@in Cϕphɛr**, such as the number **9** which represents *ending* of a command and the beginning of a new **Command Signet Program**. **9/11** was the ending of the **Freedom Program** (which could be referred to as the **7/4 Program** or the **Fourth Of July Program**, or more simply as the **11 Program**), the USA had been under until such time of the transition over to the **Armageddon Program** of the end days. That program that rolled out on 9/11 when the numerals are added together equals 11 (as in Elohim Elohim), and the 4th of July (4th day of the 7th month) adds up to the same 11. The way that numerology works to connect numbers or letters back to their original Command Signets which are symbols is through the value of each symbol. So a symbol that would carry the numerical value of 11 would be invoked by saying or thinking or writing 11, or any numbers that add up to 11. Now you know how letters: Four July, and calendar months: 7/July, are really the same things as numbers. When your clock strikes 11 minutes before or after 9 o'clock, it is speaking the invisible code of the 11 Program.

Decoding The Hive

creation of gravity, light, time and the god particle

The **11 Program** was the event that was recorded in the **Akashic Records** of earth as the *beginning of the end*. “End” in this case only means that the **One World Order Program** takes over where the **Freedom Project of America Program** left off. The numeral **9** ended the previous Program, the **first 1** began the new program and the **second 1** was the **signature** of the **Elohim** who implemented it. Obviously by now you can understand why the word (title) (mother) **NATURE** is the **last** half of the word **SIG**nature. Mother Nature has never referred to earth’s natural functions, it always referred to the beings who stole earth’s identity and replaced all her organic expressions with the Chimera Reality functions using **SIG**net Commands issued by the group known of as **ONE**. As mentioned earlier, the word *earth* today literally comes from **EA** (Enki/Marduk). Her name isn’t **EArth**, it was **Tara** at the time of her and Angelic Human’s fall, the name she prefers to still use today.

Next I will be revealing a close-up look at **Fire Letters** and **Command Signets**. This report has been building up to the answers behind light and gravity, etc., but the most important hidden secret ever revealed to my knowledge to the children of this evolution is how Command Signets work and how symbols have allowed your captors to keep you in a haze and returning back to this plane for so long under the **Enslavement** and **Recycle Programs**.

Without a deep inspection of how science has been hiding elementary particles to use that power to drive these Templates (talismans), it wouldn’t be possible to understand how in real-world terms, geometric “voodoo dolls” actually work. Until now, only Hermetic Initiates would have ever heard a word about any of this, and only a handful of Masons at the very top levels of the World Management Team. Even the word **Talisman** is a cipher code for **talus** which means rocks and debris and is another word for **detritus**. The detritus of Nibiru surrounds this planet continually between the actual planet’s visitations (which are 3657.8 years apart, which is the time when they come back physically to earth to see how things are going at the ranch), as that talus carries the codes of the flashline sequence pulsation behind all the Signet Commands and is millions of “light years” long. If you remember now, the backside of a star faces the field on the other side of that Time Matrix where that side is a black hole that is continually drawing in the random particles from that next dimensional field. That material then is broken down into quantum particles which then act as the fission/fusion power source for sending in the flashline sequence codes into the Time Matrix the star is facing. The particles in the talus/detritus of Nibiru carrying the Weasadek Matrix pulsation codes then enters our playing field carrying this signature because Nibiru is continually using the pulsation of the Central sun at the Metagalactic Core of the Milkyway to power their planet cluster which moves in and out of our solar system.

This is why all such **TALUS**man symbols that somehow represent a connection to the plasma field of another person that can affect them with physical (atomic) objects such as a pin can make the leap through “somewhere” between that voodoo doll and wherever the person might be standing that can actually do something to them have always been called **Talus-mans**. It is the same thing as a painting holding the scalar waves of that being who is now placed under the Hexagram Command that speaks in cellular aetheric language to the wave forces that control the spacetime fabric. A peace **treaty** is backed by the **detritus** pulsation of the rulers of the planet, originally called a **treatise** (tritus).

Let’s go.

CHAPTER 27

THE FIRE LETTER OF THE WHITE QUEEN



The symbols used by modern science that are all ancient Greek symbols, are chosen not because of some passion science geeks have for ancient hieroglyphs, but because they are the symbols that carry the direct, true intent of certain scientific-related **Command Programs** that have been cast into Hexes or spells that function to block human comprehension when it comes to understanding and controlling the elements, something your captors wish to exclusively reserve only for themselves. The ancient **Red King and White Queen** anagram was a **Hermetic Alchemical** cover for management of the elements, as was the portrait or picture that represented the process with the **monogram** portraits shown above. If we have a go-to monogram and analogy for what science really is, it will be Hermes' story from very ancient his-story.

Decoding The Hive

creation of gravity, light, time and the god particle

So what is the Red King and the White Queen exactly? I know it isn't sexy now finding out that the many symbols used by the Illuminati are about geeky chemistry, but then, Occult knowledge has always been about **Alchemy** to begin with:

Thoughtco dot com:

Marriage of the Red King and White Queen in Alchemy

by Catherine Beyer

*“The Red King and White Queen are **alchemical** allegories, and their union represents the process of **uniting opposites to create a greater, fully unified product** of that union.*

*Fire and air are masculine while **earth and water are feminine**, for example.*

THE CHEMICAL MARRIAGE

*Descriptions of alchemical processes often describe the reactions of **sulfur** [Nitrolite crystal] and **mercury** [byproduct of **Palladium**, another title of the Greek goddess **Athena** who is also **Nammu**, another name (upside-down) for **Wawwu**].*

*The Red King is sulfur-- the active, volatile and fiery principle, while the White Queen is **mercury**--the material, passive, fixed principle. [**Mercury** was the title for **Thoth/Hermes/Quetzalcoatl** within the pantheon of the gods of Sumer. **Hermes** was a hermaphrodite just as his brother **Pythagoras**, thus both King and Queen.] Mercury has substance, but it has no definitive form on its own. It needs an active principle to shape it. A person is comprised of three separate components: body, soul and spirit. The body is material and the soul spiritual [**aether**]. **Spirit is a kind of bridge that connects the two.***

[Hence the geometric logo of Science Of Mind shown in a moment: .]”

I promised to give you proof that your alphabet is a ciphered code, and show you how it is that the grapheme letter symbols used today came from subatomic particles as well as from the Keylon Grid Templates that carry the INTENT of the being casting the command called spells. The physical proof just shown to you exists if you are prepared to see it. It is **my** intent within these pages to give you new ears through which to hear and new eyes to see. It is up to you to merely understand we are not talking about fiction and fantasy now; we are talking about how the illusion itself was created, and doing so in empirical, scientific terms. The *spelling out* of spell commands lies in the monogram template itself, hidden in the symbols that have been used as innocent pictures all along. In the marriage between the **Red King and White Queen** from ancient Hermetic alchemy, the king and queen are always holding up roses or flowers that cross each other, forming what looks to be a mere symbolic blending of hearts as it were. But the will behind the intent of the symbol in this very special case forms an exact PRIMAL Keylon Grid. This is a big deal:

Decoding The Hive

creation of gravity, light, time and the god particle



COMMAND PROGRAM TEMPLATES

This is how the Command Programs have been instituted against this evolution. Using intent spells coded to symbols that hold the scalar waves of that intent. When a Sentient being uses their creator mind to instill an intent into anything, then the will of that creator commands the aether to hold that intent within the shapes and colors of the chosen talisman (talusman). From that moment on, the electronic signature of that picture or item will now be measurably different from what it was before that action took place. The more passion placed into the creation of the talusman (through ceremony, incense, crystal positions surrounding it, etc.), the higher electronic signature it will have and the stronger it will then “speak” to the aether.

Get a spectrometer and do your own tests to prove this. Or, you can simply take a look at the thousands of examples of how your intentions physically change the molecular composition of water droplets as shown by Dr. Emoto. His other experiments (which have now been duplicated thousands of times around the world by individuals and school classes) proved that taping the words of your intent in printed form to the jar holding the rice, speaking to the jar and rice, or thinking those words to it made the exact same change leading to the same results which would make the rice mold, sit there and age as normal in the control jar that is simply ignored, or hold its brilliant white color and clarity in the water for days or weeks longer than the others. The electric vibrations emitted by each jar will show the difference in their scalar wave signatures from the very second the experiment begins, just by measuring them with a meter designed to pick up standing scalar signatures without waiting 4 weeks to see how each jar is going to fare:

Decoding The Hive

creation of gravity, light, time and the god particle



So the science is there to prove that talusmans are real, the logos used in every military operation, every space operation and emblazoned on every flag and battle shield down through history are real, so it shouldn't be difficult to admit now that someone, somewhere, has known all about Command Signets all along because they actually work. Here I take you through the sub-quantum beginning of that process, all the way through to the working models of what talusmans really look like in everyday life. Don't be surprised to find out that every letter of this report are all secretly talusmans as well because every spoken language on earth today are coded to Command Programs that are not in your best interest. Just the fact alone that the word hate literally causes rice (life) to die should show you some of what we now face. But it goes far deeper than just that, because everyday words we use have been coded to reverse the intent you placed behind the message. Father, god, prosper, hope, care and heal are just a few.

FIRE LETTERS

The **Primal Keylon Grid** is the first base symbol within the complex **Fire Letter** geometric Templates that will follow. The Keylon holds the initial command, made up of all **straight lines**. The intent that vibrates inside those cross points and at the "buds of the flowers", are reinforced by the image of both the king and the queen who are holding the pattern in their hands in this Hermetic monogram. While the couple is outside of that template cross in the portraits, in reality,

Decoding The Hive

creation of gravity, light, time and the god particle

the king and queen are part of the geometric symbol itself by the fact that this monogram is actually a **Fire Letter** (complex) **Signet** that has been cast into a **Talusman**.

The Red King and White Queen monogram can be considered the “god particle” of the **Keys Program** used in the **Saint Peters Papal Keys** and the **Jesus Christ Keys to the Kingdom Programs**. The HEX spell cast into the Signet of this complex monogram is coded to numerals that will refer back to the structures of the 3 original Keylon Grid lines as arranged into basic numbers that will represent this complete command at a sub-quantum level. The Spirit Essence that heard the command and now will sing the song of that intent within the zero-point center of the sphere, and will then go on to assemble all the patterns that will form the shapes that represent in cellular language what that command will look like once it is in full plasma form which your captors can see and allows them to use those beautiful completed Fire Letter patterns in what they call leaded glass windows to hyper-conceal the monogram Signet images in everyday life. Hermes was showing mankind how all this works by using the Keylon Grid itself inside of the monogram, just like Jesus Marduk used the Keylon Grid itself as his personal signet



called the Chi Rho:

The base **Primal Keylon Grid** template pattern that is holding the **Intent** of the command:

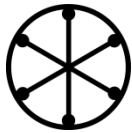

indicates the **strike points** where the waves will reflect off of the circular event-horizon, which will begin the fission/fusion reaction to generate the power for that command (we would call a *spell*). Later, those lines are replaced by the **pattern** that is visually printed out by the waves *bouncing off of sphere*, revealing the **Partiki Template** pattern (the very first stage of the long-line of Templates that will be created by the waves themselves) that you have been



allowed to see many times that shows both tetrahedrons of the full hexagram

This **Signet** is a *very big deal*, because while you have been openly shown the star of David on a common basis, it is highly risky to ever reveal to mankind the building-blocks of an actual Keylon Grid itself used inside of a complete, functioning Fire Letter monogram as Hermes has here. With just the Hexagram star, or just the Pentagram star (which is another layer over the TOP of the hexagram), it is a fairly safe bet that no one would ever figure out anything regarding **Scalar Vibrational Science** from the signet of the chemical marriage. The base-code for all Scalar Science not only carries the process by which the first talusman of the command-sequence is used, but it also shows the form from which your CAPITAL LETTERS partially originated. Capitals were created through a combination of **organic 3-D particle patterns** that ions and neutrinos print out in the air and water as we covered previously, along with the straight lines from the Keylon itself. Hermes was taking a very big chance with this disclosure and I am sure he did it because he never imagined that the code would ever be broken.

Decoding The Hive

creation of gravity, light, time and the god particle

This reproduction of the king and queen (and the dove, lion, sun and moon all together) holds the vibration of how that **Primal** energy will be used, making them part of the overall template, just like any combination of symbols held inside a leaded-glass Keylon Grid in a Catholic church might appear as “random” to your eyes, but they are precisely combined together to form a geometric **signature** of the intent behind that Template. This is why it is referred to as a **signet**.

EXAMPLE OF THE CREATION OF A FIRE LETTER

The leaded glass **Fire Letter** Template below has the entire **code** written within the heavy black circular area, and shown to you how the aether views and prints out the actual wave of the mission-command. Outside the circle you see other common symbols of the **G.O.D. Program**, such as the rose, the dove, stars and the Alpha and Omega which are part of the original Signet of this spell. Those physical symbols holding the shapes of the dove, etc., did not have to be part of this **Command Template**, but they were added just to reinforce the effectiveness of the Template (like multiplying the command’s power by 2). This is part of the **Recycle Program** family of **Signets** denoted by the **cross** in the center:



The geometric image below was created by sending a sound through a Cymascope which reproduced exactly what the resonant tone of the word or frequency looks like as the particles in the air, water, sand etc. form. At the base of its tone is the Primal Command of the Recycle Program crucifix which the Sumerians have been using for eons of time and long, long before this modern civilization when Marduk brought it back into mainstream to back his Jesus Program

Decoding The Hive

creation of gravity, light, time and the god particle

appearance to use as the basic symbol of his church, now called Catholic. I will be showing you how it was used many thousands of years ago in ancient Sumerian times later:



SCIENCE OF THE COMMAND SIGNET

- When a **Sentient Signature Spirit Essence** (self-aware member of the god family) has a thought, it creates a spark. The spark makes a sound. That sound creates a **Sub-Quantum Intent Keylon Grid Template** that forms, made up of a **Hexagon** as a foundation for that intent, regardless of what that might be. The Template will carry whatever curse or spell placed into it, as there is no such thing as good or bad. All things are the realm of gods. The undistorted Hexagon is entirely within the **aetheric level**, not in 3-D visible form. This is the primordial beginning of creation within the organic **Holographic Hexagram Scalar Vibrational Mechanics** aetheric language (I call **cellular** language, as it is literally written inside your DNA codes as part of your manifestation package) of the **15 Level Time Matrix of Gaia** known as **Keylontic Science**. The **Hexagon** is actually the quantum shape of a **Sentient being** who is currently acting as one fractal of the aether (the army of Spirit Essences who are serving as the “worker bees” from the **Eternal First Fields of Light and Sound**) who will go on to flash colors that will simulate material things within a Time Matrix on behalf of a **Signature** (self-aware) **Spirit Essence** which is a **manifest god**. (We could call them dudes or ladies, but I use the term god only because they are from that family. I don’t use it as a title.) This **Krystal Spirit Essence** will be **flashing** or pulsing on and off through **thought**, which will send out the intent behind this mission to all other **Spirit Essences** that will be relaying the

Decoding The Hive

creation of gravity, light, time and the god particle

messages from one pixel to the next throughout the **spacetime fabric** of **holographic manifestation**. It will remain an aetheric, multidimensional particle throughout its journey. The frozen-water crystal I show to represent this Spirit Essence is not a graphic illustration, but an actual crystal that self-formed here in the 3D level. The Hexagon that is around it was made to precise mathematical geometry which the crystal fit into exactly without modification. If the crystal were not Sentient, this would be a physical

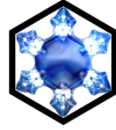

impossibility. This is a light bulb:

- If you were to “connect the dots” in a crossing pattern within a 2-D layout between the strike points of the Hexagon, it creates **lines** which make up the 3-D world physical **representation** of that **Intent Keylon Template** which is still **aetheric** and lies **beneath** the energy that is used within the Gaia Time Matrix operating platform. The **Spirit Essence** (aether) radial-points connect these dots between the strike-points and the **6 dots** now become **3 Primal Lines**. The points and lines at this stage are still outside of visible, 3-D reality and merely carry the **intent** of a god member to **bring up electricity** from the **Standing Energy Fields of god source** into the **Gaia Hologram** and act as the bulbs that will flash to transmit the song of your intent message through different **colors** they will



flash that will hold the pattern of your command:

- This forms an **Intent Sphere** (torus field) that surrounds that Sentient being carrying your intent and the Hexagonal radial-points lay out the **Grid Pattern strike points** within the sphere where the sound waves of your intention will bounce off within that **event horizon** in order to compose or generate the song of your wish or command. This creates **6 strike points** inside a sphere or circle as shown here in **2-D**. This is the first moment when your intent transitions from the aetheric level and into the **3D** manifest world, allowing scientists to see the strike points which they call particles that are now ready to print a pattern with their light waves. The outside circle is its **event horizon** science calls an orbit which does not actually have to be part of the Signet that will be

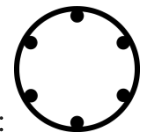

used as the monogram to represent the intent you commanded for that mission:

- When your **song** has been composed and the crystal being begins singing it, the wave pattern that the song produces now appears as a **Hexagram** or **6-pointed star**. That geometric pattern created by sound prints out in light and will eventually begin to form something within the material world (inside the hologram) through the scalar waves that continually broadcast out of its torus field (merkaba field). Merkaba, or torus are just other ways of referring to the event horizon of the sphere. The **black circle** in the center shown in the illustration is the **zero-point** within the song pattern which is a **back door** that allows the **Sentient being** (aether) carrying the command a way of escape should it

Decoding The Hive

creation of gravity, light, time and the god particle

be necessary. It also allows the song to move in and out of material reality as needed. The



circle is a black hole which is a **quantum stargate**:

- Because the flashline sequence (time regulation protocol) was altered for this dimension through manipulation of our organic sun through **Niburean Detritus** to direct **Metatron-pattern scalar wave commands** from the Weasadex Phantom Matrix (like a voltage reducer), the Hexagram energy *first appears* in this reality with the original 6 points as shown a moment ago, but now with a *rider* or **carrier wave** that will physically neutralize one of these strike points (placing that position within the **Intent Sphere** outside of where the waves will be able to *bounce off*, distorting the keys or pitch of the song).

The quantum transformation of the 6 points of the **Intent Sphere** then comes into “particle form” (before taking wave form) that can be seen at its most basic level by science, which is the first view they have of this energy within the 3-D spectrum beginning to form what will become matter. That particle cluster is known as **Aniline**, which is deemed as a carbon crystal by science. Keep in mind, this is the shape of the **Intent** (mission song) of the crystal. I will be showing you a photographic image of the **one being** carrying the song itself later. An Aniline is the *action* of the crystal, *not* the aetheric crystal being itself. Above the very top strike point within the **Intent Sphere** now carries with it the **Metatron Nabla tetrahedron** ▽ (the actual shape of the symbol for the “god” Sal(t)/Wawwu), that acts as a **phase-converter** that cancels out that peak section of the sphere.

The following three images are the actual illustrations from the scientists who have witnessed the forms under scanning electron microscopes showing the quantum level shape of a carbon crystal they have titled **Aniline**, which is the particle that is now placed



in the screen pixels of OLED smartphones to produce the **picture (flashes)**:

- The shape science sees as the **Aniline** continues to form into what they would refer to as a *particle* will begin spinning together as a cluster to form the out-of-balance shape of an atom now shows that **Intent Sphere** with a physical **crown** on its head. The **crown**



tetrahedron (Nabla) ▽ now worn by the Monarchy is the **Anunnaki Particle**:

Decoding The Hive

creation of gravity, light, time and the god particle

- Once the full **Metatron Pentagram Intent Sphere** now manifests as an atom (**Adam**) and is ready to begin taking the shape of something material, it then looks like an out-of-



round sphere, using only 5 strike points to generate the song of the mission:

- The 5-point operating platform of Metatron **overlays** (like a facehugger from Alien) the 6-point operating platform of the Hexagram the moment a command enters into *usable energy* (becomes **electromagnetic**) within the 3-D world and turns the **Gaia Hexagram Operating Platform** into the **Weasdex Metatron Pentagram Operating Platform**



(think gaming platform):

- The physical pattern printed out that is then commanding the aether within this dimension now takes the **oblate spherical wave** that is represented as a **Pentagram**. This begins the **Chimera-Reality Enslavement Program** which was applied to **Program Command Signets** across *hundreds of millions* of **Fire Letters** the invader races actually went on to create to hold the **baseline primal-command intent** of the capture and enslavement of



humankind:

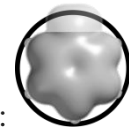

On a quantum level, it physically looks like this inside the Sphere:

Under this technology, everything which manifests within the hologram will appear smaller, weaker and not as refined in appearance, because it uses very ancient and rudimentary science compared the to **Hexagram Scalar Vibrational Mechanics** Angelic Humans had been given for their highly advanced evolution of the most sophisticated Avatar ever concieved at that time

- If you were going to physically write-out a **Command Code** by hand in 2-D like a mathematical equation that would actually work under the flashline sequence in place



now, it would always begin like this: + plus any additional **Command Signets** after that in order to add up to the finished product that now is able to take shape within the counterfeit projection platform. No matter what manifests today, it has to be generated by **Base-8, 5-point Metatron Operating technology** which is why the golden ratio of **Pi** appears to science as the actual code of life today

Decoding The Hive

creation of gravity, light, time and the god particle

- Once patterns come into view to modern science, they can be seen at a quantum level as they begin printing out colors within the **pixels of the spacetime fabric** that is now operating in the **Metatron Code** which is a cube in form. The **Base-8 technology** uses **5 points** in which to operate; one at each corner of the frame, and one at the center of the event horizon (in the zero-point). When in 3D form, this creates a **square box** where **Base-8** gets its mathematical designation from the **8 corners of the cube**. When scientists annihilate a **Sentient aether crystal** carrying the parameters of a 3rd dimensional mission inside what is called a *nuclear event* (splitting an atom), the only thing they are able to see is the light that emits from the core of that crystal, and the form it takes at its most basic level is in the shape of a **cube of light**. This is a view of the explosion taken from a distance. I will be showing you a much closer view of what the rays of light coming from the event look like from a **base-quantum level** of 3-D at the end of this volume. You are now looking at the actual interior of a single **spacetime fabric quadrant pixel**:

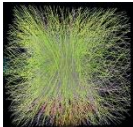

- The 5-point **Base-8 Code** that now uses the energy stolen from the Hexagram platform, *prints out* material things which can be **emulated** with a **symbol** that can be used as very powerful talismans to continually broadcast their message to the aether of their intent. At the bottom of where material manifestation begins to appear within the 3-D realm, those 5 points can be used as a **Baseline Primal Command Signet** for symbols to represent the original **Enslavement Program**. Under that Program would be the subset **Pentagram Program** to back up that intent. A *curve* is usually **2 lines connected**, but within **Signet symbols**, a direct path from one strike-point to the next can take any curly pattern it likes, as long as all the strike points are covered. One symbol that has been used for the **Pentagram Program** as a **Primal Command Signet** (using the least possible lines within the event **Intent Keylon** horizon) and entered into mainstream use was designed



to appear extremely positive (as most of their symbols do):

- This **Primal Command Signet** surrounds you wherever you go within the Chimera Reality, because it is printed in the quantum fabric of the life forces around you, making it impossible to escape its reach. Every repeat of this symbol carries its own merkaba field around it, telling the aether and all things within that event horizon that its intent is the **Recycle Program**. I mention this only to give you a frame of reference as to how thoroughly your captors have done their jobs. This is a single blade of grass at a cross

Decoding The Hive

creation of gravity, light, time and the god particle

section under a scanning electron microscope. The mouth is the water channel:

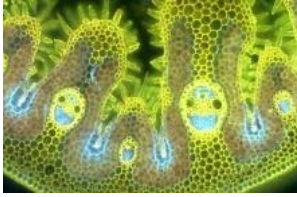

It is also printed on the wildlife:

- Remember, this is **Base-8 Scalar Science**, so the pattern the dots actually form inside the sphere are in the cube pattern at their quantum, even though the pattern of the 6-to-5 strike points are typically followed with Pentagram symbols. The cube is **4 corners** and a center, **zero-point**. One of the most prolific **Pentagram Baseline Primal Command Signets** in use today is the letter X. It stands symbolically for the **god particle, Nibiru** (the planet of the **crossing** also called **Planet X**), **Wawwu** and innumerable others, as it is the **fundamental** symbol of the **cube**. Inside that cube is also the tetrahedron Delta/Nabla, so either symbol will be able to be used interchangeably to each other as Primal Command Signets shown in a moment. Since the cube technology brings all things “to life” within the **Chimera Reality**, the cube is number one across the spectrum within the 3-D material world. It is the hidden X inside the equation for the YZ coordinates for giving any geometric cube its depth (the brightness of its flash in science), or the depth of its sway in mathematics. This shows you that the points can



move within the **Template** of the **Signet**:

When you see a **Pentagram Baseline Primal Command Signet**, it is strictly there for the purpose of blocking the incoming neutrinos from the sun from reaching your pineal-gland to properly charge the energy-carrying ions in your blood, clouding your thoughts and keeping you in a low harmonic frequency-spectrum that is unable to support the super-high vibration levels originally given to the Angelic Human which is able to process data and return clear results many, many times greater than what is possible using **Metatron Platform** technology. Even though the flashline sequence pulsation rate from the Weasadek detritus is lower than what you had originally been set to have, the waves from the sun we have now still carry the highest level of energy you have available at this time.

- A **Primal Command Signet** for both the **Hexagram 6-points** and the **Pentagram 5-points** which both represent 100% of the manifestation energy on the planet has been created for every possible symbol that could fit those respective-point patterns, just like

Decoding The Hive

creation of gravity, light, time and the god particle

reserving a Domain for your product's website will be done using .COM, .NET, .ORG, .TV, .ME, etc., to keep anyone else from being able to use that **SIGNET** (title) for a counter-spell application, and to give you absolute freedom to market your product in any form you choose. Both patterns have been used as **Pentagram Program Signets** to represent the **Primal Command** of the **Enslavement Program**. This is the single most powerful collection of Signets on the planet, which is why **Cops** (Qoppas; more on that at



a later time) use them both:

- In an even a more simplified **Signet** for the **Enslavement Program** is the single **Tetrahedron**, or the top, **manifest** side of the two-sided Hexagram, as well as the same shape of the **Metatron Delta** Δ representing the top peak (the first strike point) of the **Hexagram Vibrational Scalar Science** that had been removed from the **Gaia Hologram code**, which would make this, along with the 5-point cube, the **quantum** of this **Baseline Primal Command**. Because it doesn't appear as a Pentagram or a star of David, (or a doofy smiley face) but as an innocuous and religiously-neutral shape, it is the primary symbol used by those who are hiding in plain sight, but at the same time are really projecting the intent of your perpetual enslavement. It is the most basic form of that Program. The circle can be outside or inside of the Signet and can be vertical, horizontal or inverted. It has been used as the **Trinity** symbol under the **G.O.D. Program** (a **Compartment** or division under the **Enslavement Program**), reduced down to the **periods of all written sentences**, used as the **letter V** (and **A/a** and many others) and implemented as the absolutely-required **@ sign** in order to send an email, etc. in order to completely saturate the 3-D world with the standing scalar waves that continually broadcast the message to the aether to continue the mission to keep you from connecting to higher levels of energy and therefore to higher levels of awareness. To my knowledge, the **most primal** of all such Signets will be made with **straight lines** from the original



Intent Keylon Template:

- And on a quantum level, hovering over the 6 strike points of the Keylon Sphere of the Krystal Seed Atom called Aniline, the **Anunnaki Particle** first appeared as a downward-pointing tetrahedron as in the **Nabla** ∇ (that will be covered more in a bit). When the aetheric **Keylon Command Template** began manifesting 3D reality, that entire cluster of strike points along with the tetrahedron inverted, producing the Delta Δ , which is technically the Alpha symbol. This would make the Delta the baseline-quantum for the



Enslavement Program Signet:

Decoding The Hive

creation of gravity, light, time and the god particle

- That symbol would physically look something like this within their **Program Commands library** under the **G.O.D. symbol**. Of course the details of the Delta shape would disappear to your normal visibility due to the size it was reduced to and the

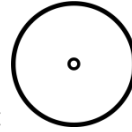

thickness of the lines they used in the original Signet:

- Here is a close-up of the periods at the end of every sentence. Keep in mind the white

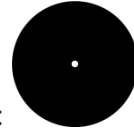

space at the center can be the size of a single molecule Δ and can be a cube:

- The commands do not have to be inside a circle, they can be any size from a single atom all the way up to the largest image. The **Primal Command Alpha Delta Signet** is not just used in all sentence periods, all grapheme letters of A, a, v, u, etc. they are also all



around you:

- Such **Primal Command Signets** that carry the full power of different subset **Programs** can then be grouped together with others to form even more complex **Fire Letters** (complex Command Codes), in a new **Program Command Template** that carries forward its own commands plus all the commands of each **Primal Command Template**. They can also include other Fire Letters (complex commands) as well, but the new Program Command in order to work, will require every one of the *ingredient* symbols within each one of those Templates to be present within the new painting, leaded-glass window, etc. which dilutes their power because there will be less complete Templates carrying all of them together already around the planet. This is why the Primal Command symbols are the most desirable and most used such as in pendants worn by stars, shown in films, etc. because with a **single word** or a very few words, every Delta/Alpha symbol in all its forms (billions) will become re-activated (jolted) to command the aether particles surrounding those symbols on earth at once. This example of a basic Fire Letter Command Signet with just the Delta/Alpha Primal Signet, along with the **captured earth Signet** and the **number 1 Signet** included will now link to all those individual Primal



Command Signets which would reach into the trillions of trillions:

- The new Signet may now carry thousands or hundreds of thousands of spells all piled on top of one another. An example of a **Fire Letter Command Template** will have two or

Decoding The Hive

creation of gravity, light, time and the god particle

more **Primal Command Signets** inside, or even Signets from other **Fire Letter Command Templates** such as the one I assembled just as an example using the Signets within the Catholic church leaded-glass window at the beginning of this section. The patterns that this Signet print out in pure light through interstellar **cellular language**



might look like this to you in their **Signet** form: but it looks like this in its **3D**



form to the aether:

- In the case of the Red King and White Queen **Fire Letter Command Template** shown at the start of this chapter, that uses that **baseline-quantum** Signet of the **Delta Δ**, then adding additional symbols to layer a new **Command Sequence** for the introduction of the **Electricity Program** over that (which would have been needed during **Herme's** period where Greece was reserving all electricity-use for royalty only), it is more than obvious that Hermes knew all about what he was doing when he created the scientific monogram for this chemical reaction and was pushing the edge of just how much of the system he was showing. He produced the **3D Fire Letter Command Monogram** (the painting) to represent the marriage/birth of atoms symbolized in King and Queen holding up the flowers that was revealing the way that **Keylon Command Templates** are created by the thought of the god who cast the command, deliberately revealing to people both forms of the **Command Template** process;



- the **Keylon Intent Template**:
- and the **Fire Letter Command Template** (king and queen) which included the 3 lines base-code of the **aetheric patterns** into the one



painting:

- On top of this he also produced the **Signet** for the **Fire Letter Command Template** showing you the **baseline-quantum Primal Signet**, plus the 3 lines of the **base-code** coming out of the bottom as arrows, and the top of the 3 lines as fire, invoking the



number 1 command, because there are **7 points** to the flame:

- Realize that the number 7 is the number 1 (spoken, thought, printed). Yet he did not need to actually put the number 7 directly in your face, as there have been

Decoding The Hive

creation of gravity, light, time and the god particle

innumerable Signets cast into use that connect the Primal Signet of the Elohim as 1, 7, 9, 13, A, a, V, v, etc. to cross-connect these Signets back to the **Primal Command**. As far as the Anunnaki's hidden disclosures go, this would rank among the most brazen and in-your-face clues he could have come up with, and again, deliberately as a clue so obvious it would stand as true disclosure (in his mind).

You will soon see where those arrows actually originated from their manifest level. Remember this; the arrows are the physical, **manifest 3D Fire Letter** image of the element.

When I say the number 7 is the number 1, realize I do mean every single form of 7 that exists on the planet and above the planet that is radiating down the scalar waves

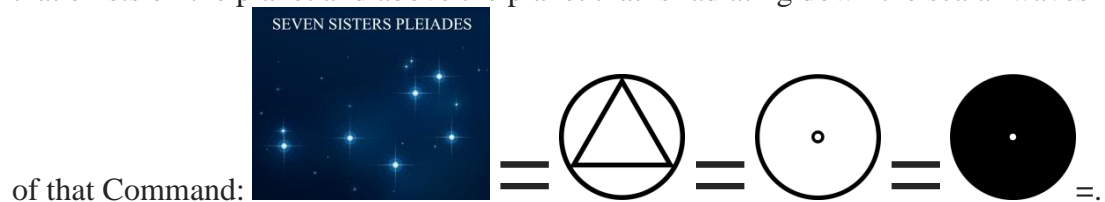

Each Primal Command Signet or more complex command successfully interwoven into the new Fire Letter Template, the more powerful the Template becomes, due to the inclusion of more physical Templates already out there as mentioned (at least when all the symbols are present together within the Merkaba field -torus field- of each symbol to one-another). Herme's Red King White Queen **painting (Template)** includes too many commands to list, but because the fire/arrow/Alpha Signet above has been linked back to the painting, they both include all those other commands. Are you beginning to see how this works? The Signet (simple icon) includes much more complex Fire Letter Templates just like an *adhesion contract* as will be explained in a minute. So the painting can be printed somewhere or the Signet can be stamped out somewhere, and each one will have the same affect, even though they appear completely different from one another. A Signet with a single circle in the center could include 5 hundred command sequences through this totally unseen, unspoken language. And each Signet can be invoked by repeating the word or words that articulate that intent. *Abacadabra* literally means "I create as I speak".









I might just mention here that the smaller the Signet (such as a period in a sentence for example), the less actual energy it possesses to speak to the aether, as the torus field around everything in physical form reduces the smaller that thing is. So a large painting on the wall of Mona Lisa will be thousands of times stronger in electromagnetic energy transmitting out of her scalar waves than the period and maybe hundreds of times stronger than a penny or Lepton Signet coin.

REFERENCE CHART KEYLON COMMAND TEMPLATES

- Sub-Quantum Intent Keylon Grid Template (aetheric): 

Decoding The Hive

creation of gravity, light, time and the god particle

- **Intent Keylon Template (aetheric):** 
- **Partiki Template (aetheric):** 
- **Intent Sphere (3D):** 
- **Primal Command Signet (3D) close up:** , can also visually appear: 
- **Fire Letter Command Template (3D):** 
- **Fire Letter Command Signet (3D):** 
- **3D Fire Letter (3D):** 

CREATING THE SIGNET

- Creating a new Signet can be achieved with any symbol such as a leaf, a chair, or just using the 6-point Hexagram. The symbols do not need to be drawn on paper or a screen, but just held in your mind's eye as you cast that command. Obviously if you use a symbol that's already in use for a Program (which is almost guaranteed, since nearly everything now is a **Program Command Signet** from doves to lions to bunny rabbits, so your new spell will conflict with the old one which will physically alter the resulting "song" and the aether can't hear and understand the weaker command. This has happened to the words we use in our nomenclature today, because we are using **letter symbols** that are all **Signets** to form our **words** that have also been made into **Fire Letter Signets** that we intend to mean one thing, and the **Program** behind them says another, so the aether hears babble at most or nothing at all. But for an example of how to create a **Fire Letter Keylon Command Signet**, your symbol might be a combination of anything around you for the printed shape that will hold the command such a "fork and spoon". In the case of the **Fire Letter** leaded-glass at the beginning of this chapter, that was obviously "*the crucifix, a rose, 3 stars of David, Alpha, Omega and a dove*" that could be assembled in any fashion of their choice for them to envision in their mind's eye while placing the command into creation. In this case, it is automatically assumed this is a **Recycle Program Signet** due to the **crucifix** in the center, a **Compartment Signet** to the **G.O.D. Program** (and inclusive of **many** other Programs as well).
- The original Sumerian **Recycle Program** pictograph **crucifix** (pre-Egyptian and at least 6000 years prior to Jesus Marduk) symbol was a cross attached to a skull as the full

Signet of the Crucifix Program): 

Decoding The Hive

creation of gravity, light, time and the god particle

- Symbols do not have to maintain their exact form as used at the creation of the Program Command. Thousands of years after the first use of the Sumerian Recycle pictograph, the skull was raised up to the middle of the cross above in the form of the skull of Jesus, completing the full Signet. It can also be represented with the lines of the cross adjusted and still carry the exact same Command code such as in the **322 Masonic Skull and**



Bones Society emblem:

- It does not matter if you can see the skull inside the cross, it only matters if the skull is symbolized in (connected to) the cross' image in some way. As mentioned, you can reduce the size of the skull within the Signet small enough to disappear to the naked eye, even to the size of a single molecule located within the standard + cross somewhere and the aether will still see it and carry out its commands. **Microprint** is a very big part of the **Signet Program** as well as the **Color of Law** or **Contract Program**. The lines surrounding important documents of your life, signature lines etc. are often **Adhesion Contracts** that are actually part of what you are agreeing to, even though they are printed so small you are unable to see them. To them, this is a valid agreement which means that anyone signing this check is authorized to endorse it, holding the bank not liable no matter who signs on this line. In **Contract Law**, this is 100% valid even if no one ever mentioned a word about it to you:

Decoding The Hive

creation of gravity, light, time and the god particle

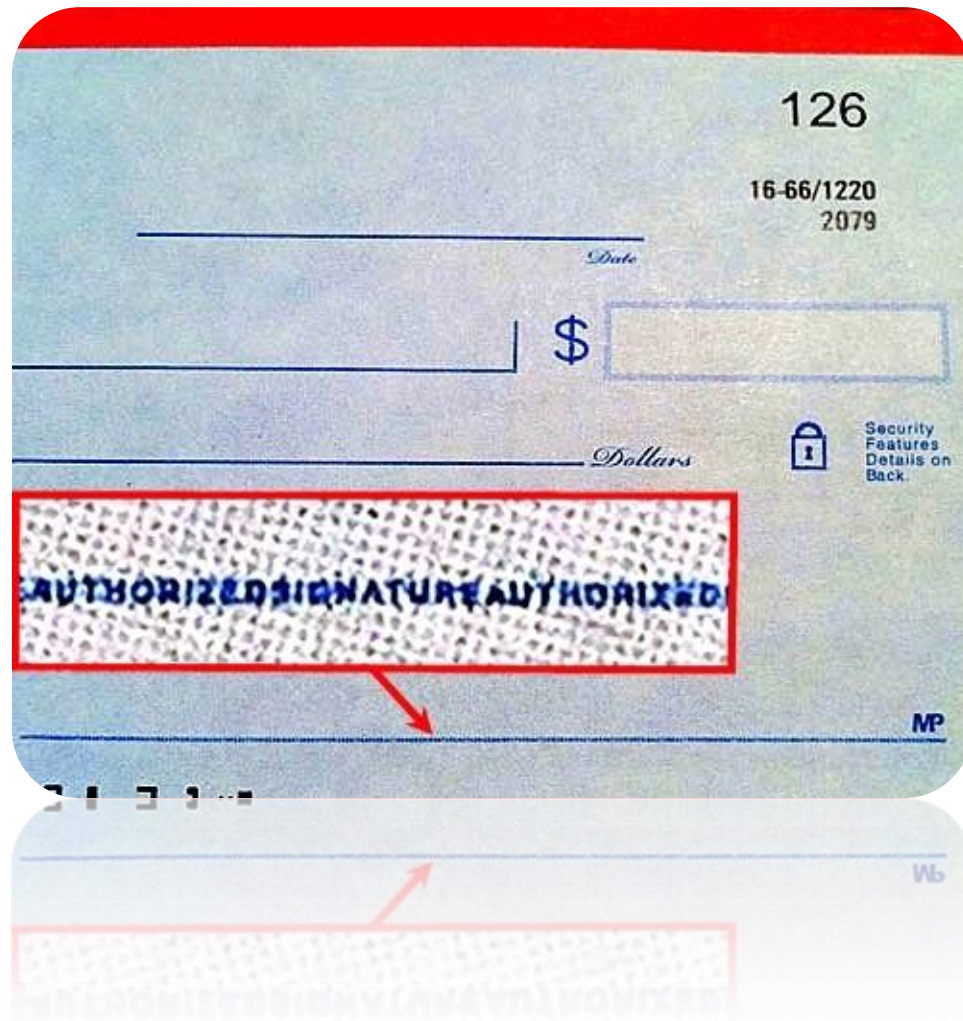

- Once that **Program Command** has been set in place, the Crucifix skull and cross can be used inside of any other Program Command Signet and it will carry all the parameters of that spell, now combined with all the other elements covered in the more complex Commands dreamed up later by the Sumerians. If connected to the **Dove Program Frequency Fence Program** (which is one of the seven layers of and subset Program under the **Zeta/Draco**), it will now ensure that while that layer of the Fence is still in place, you will be unable to move from this dimension at the time of your death, because you will have been following the **G.O.D. Program's** initiative where you will be buried in the ground or in a mausoleum, trapping your DNA inside this dimension, and further cursed by the priest's ciphered eulogy. (**100% of your wet DNA** must be annihilated inside of any dimension for your particles to mechanically transmute to any other dimension such as what happens during a **Stargate Ascension. Cremation** is designed to leave some of that DNA behind deliberately as well.) So the **Fire Letter Command Signet** behind the **3D Fire Letter** leaded-glass window above (which

Decoding The Hive

creation of gravity, light, time and the god particle

includes **many other** Programs) could look like this, or any other arrangement of the



Primal Command symbols chosen for this Program as previously mentioned:

Regardless of how many other symbols might be included later around the Signets that originally formed that **Fire Letter Command Signet** placed before you, as long as these original symbols are in there somewhere (even if they are so small you cannot see them), then the new Command will be effective. The larger, the more electromagnetic scalar energy. The circle we show around the example Template above does not have to be present for those Signets to work under the new Fire Letter Template, as this is the halo of the Merkaba field which is outside of your vision. Obviously there aren't circles around all the letters we use, and they absolutely function to carry the codes to the aether. There are only a few of the symbols used in our alphabet today that carry the spherical edge around them, one being the @ sign, another being the Θ Greek Q (Qoppa). Both of these are **extremely aggressive** Primal Command Signets which are also **subset departments** of the **Recycle Program**.

- Once the **Primal Command** is cast into creation, it will automatically assume the **Primal Command Keylon** at its absolute center (the 3 lines), as the aether assembles this by default under any **Primal Command** grouping of symbols (such as the word **Love** for instance, made up entirely of god letter **Primal Signet** symbols). Once those 4 letters have been grouped together into a **Fire Letter Command Signet**, the O is the zero-point in Love and the e is the event horizon sphere to give you an example of how size and location doesn't matter. As long as the symbols are immediately grouped to each other in some way, such as added together to form a word (spell), -even if that word is misspelled-, or inside a circle like our example window above, the Fire Letter songs remain which are now all blended together into a symphony.

Once the **Keylon Template** is formed, it goes through instant transmutation into a **Partiki Template** which is created by the Sentient being (crystal) inside that Hexagon. As just mentioned in the first part of this section, that Hexagon then takes the shape of the



Hexagram as it begins to move now into the 3rd dimension:

- The **Primal Command Signet** Hexagram naturally pops out into a full 3 dimensional



sphere of photon-waves (the torus field) surrounding an aniline crystal:

- Once the spherical hexagram forms, then the frequency waves emitted by the **Black Sun** strike the brand-new template, and the **Flashline Sequence** of the **Metatron Scalar Vibrational Science** pulsation rate transmutes all 3rd dimensional *matter* into an **out-of-**

Decoding The Hive

creation of gravity, light, time and the god particle

balance sphere as just covered. Until this time, the **Hexagram Sphere** had been in perfect spin, creating a perfect sphere. This new out-of-balance distortion called **fractional spin** by modern science indicates an *atom*, or *3rd dimensional* particles that are now **holding the shape of**, or **acting like** a certain material thing. So now the hexagram turns into the Pentagram (oblong spherical form) that has hijacked the hexagram energy, turning it into **Metatron Pentagram** form. All 3-D life around you then follows the **parabolic curve** of the **Fibonacci Sequence** to form what we think of as our world. Nothing within this Chimera Reality appears as it would have under pure **Hexagram Keylontic Science**. Again as a reminder, that is now the Hexagram-turned-Pentagram:

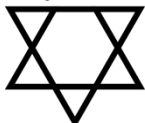

- **Hermes** knew all about this fractalization of the original **Hexagram Scalar Vibrational**

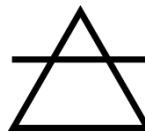

Keylontic Science language and showed the symbol for earth as:

- It is this point that the **PRIMAL COMMAND SIGNET** now begins to **take Metatron Pentagram form**, turning the Signet of the “the crucifix, a rose, 3 stars of David, Alpha, Omega and a dove” into a sphere (called Qubits in quantum computation), and the **color and sound** made by each one of those **individual** symbols combine together to carry a **new signature** song of that entire INTENT behind this new Command Template. This song will always carry within it the intent of this complicated combination of many different Programs and anyone within the **torus field** (electrical sphere created by the standing scalar waves emanating off the symbols) of that song will be entranced by it on hundreds or thousands of different levels. That sphere will be made out of pure light and will look something like this (shown here in 2D form). This is a **Partiki Template**:



- There will be millions of progressively larger and more complex Templates that the aether will create like the one shown above as it follows the complete sequence of bringing that intent into reality through the physical **3rd dimensional** magnetic push-pull energy used within the manifest playing field. By the time it reaches its full form, holding inside all the many layers of geometric templates all stacked one on top of the other, the actual image that is only visible in the form of light made up by millions of different

Decoding The Hive

creation of gravity, light, time and the god particle

colors all swirling around each other, printing the pattern as shown below again to make



this point. This is now called a **Fire Letter**:

This shows you that the basic or PRIMAL template to Keylons can carry any intent and as long as you have the initial Key to the grid at the foundation you can use any combination of symbols around that to hold the vibration of the command. The straight lines within this grid can be symbolized then later in any form, such as in letters like D that might be the original **Primal Command** symbol for the **Dove Program** or much more ciphered letters like the X which stands for the **CrucifiX Recycle Program**.

When conjuring up (magnifying) the power of a Signet, you will hear a priest or shaman repeating certain words in a precise succession and articulated in a precise manner. What he is doing is amping-up the power of the Signet each time he speaks the word or words that is associated geometrically with the symbol to infuse energy into the aether surrounding him, which then triggers a release of larger energy held inside the crystals within the spacetime fabric to “get that job done now”. The energy behind each Signet is real-life electromagnetic electricity that acts as a primer spark that connects the + and – energies that lie dormant inside each crystal, just like a light switch that connects your power to your home to power that light bulb.

The letters that make up the names or titles that define each symbol within your new Fire Letter Keylon Template can then be used together to form the verbal spell that audibly represent that entire command which can be repeated by anyone later to invoke that original intent. Since you will have cast your command on a symbol or symbols that you will either be printing out on many thousands of stickers, magazines, a million newspapers, etc., then when they invoke that command, they will be reaching energy crystals all around the country at one time, making their conjuring extremely powerful. Every letter within every word, and every word used by mankind today carries a different PRIMAL KEY. These keys are reinforced by using the physical patterns that the neutrinos and ions actually print out in the water and air beyond your view, and they will also carry the straight lines of the PRIMAL KEY as well. Sometimes these are simply a drawing, sometimes they are letters forming a word. No matter how the overall Keylon Grid has been symbolized, it will carry its own unique signature inside it in factually real patterns that sometimes can be decoded as shown with the crucifix in the middle of the leaded-glass window.

In the case of the symbol being spelled out with the Red King and White Queen above, it is obvious that this is not just another **Command Template**, but it represents the full power of the combination of both the aetheric (multidimensional) and atomic (3rd dimensional) marriage between neutrinos and ions, by showing you directly in your face the actual Primal pattern itself that lies beneath all other higher symbols held within all other Templates. In typical Hermetic Alchemy symbols, merely the tetrahedron and the cross will be shown at the center, then surrounded by the (6 sided) hexagon that the truncated pentagram rotates within. The sheer number of individual Command Programs represented in this one Hermetic image below would be too great to even count. Each Command Signet is also surrounded by the verbal words needed

Decoding The Hive

creation of gravity, light, time and the god particle

to invoke the command at any time. You do not need the Signet to be present when you are speaking the words that are coded to it:

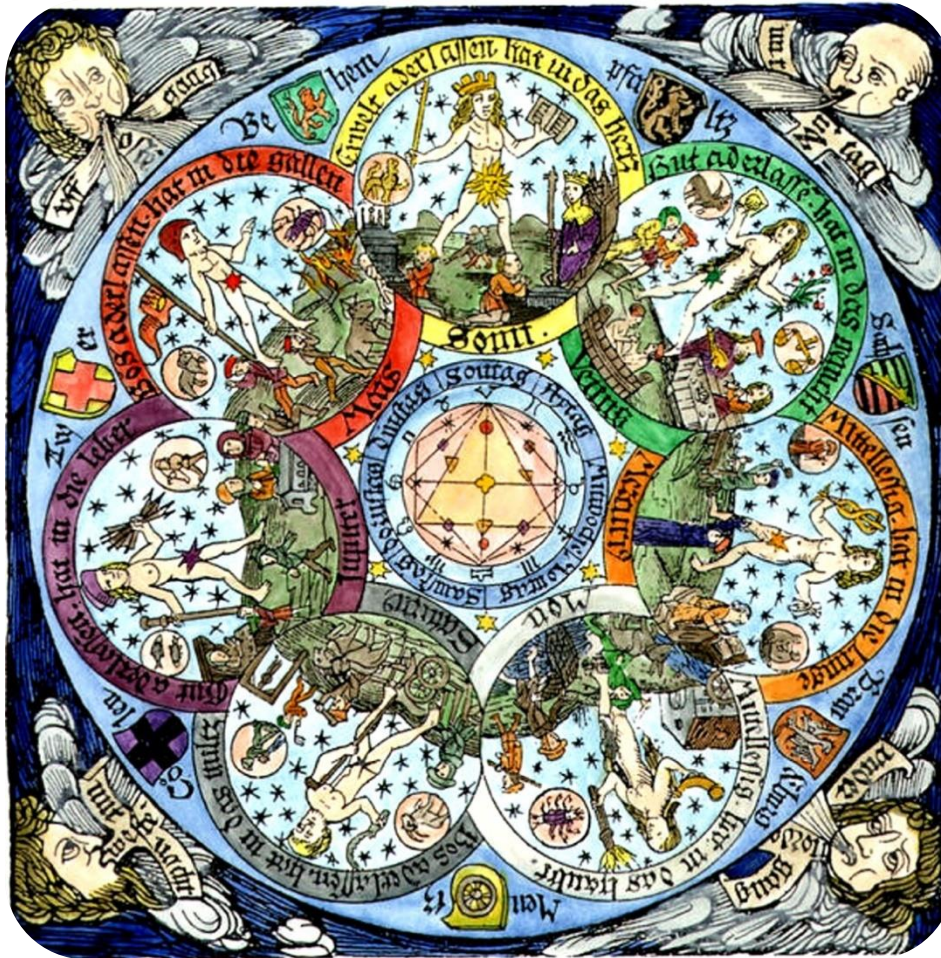

To say the image above carries “evil intentions” for humanity would be like calling the ocean wet, at least within your perspective of being the fly rather than the spider in this case. Millions of years’ worth of Primal Intent Commands blended with innumerable Fire Letter Commands have been layered over one another to the point where the interlacing of virtually every element within your reality has been covered. Which means you could live under a rock and still be affected personally by its mere existence within your land area. The defacing of statues and hieroglyphs that has taken place on a constant, ongoing basis between invader races who are educated on this subject have been meant to erase such spells out of their world. While we see a magnificent statue of a winged, 4-legged Anunnaki chimera that somehow survived from ancient

Decoding The Hive

creation of gravity, light, time and the god particle

times today as a priceless work of art, in reality it is a huge Keylon Fire Letter Command talusman that reaches aether crystals up to 100 feet in every direction surrounding it that is manifesting the reality of that species to continue to rule over all those who gaze upon it.

The physical subatomic reactions between neutrinos and ions are placed into parables around the two fictitious beings in the story of the Red King White Queen marriage as disclosure (or what they consider disclosure). The “marriage” between these two elements deifies the relationship between what is material and the energy that drives that hologram that is aetheric or multidimensional. Symbolic deification is a constant in all sciences, just as hidden away from the masses’ understanding as Hermetic teachings are themselves. This is displayed by the fact that Greek Symbols are only used in the sciences, not in your everyday lexicon, as they are the KEY(lon) symbols regarding the energy and power that drives the Templates that create the Chimera Reality around you.

The symbols of the Fire Letter Keylon Commands that have been placed around you do not just appear within Hermetic or other ancient signets, they are the fabric itself of your reality. Every priceless painting that might look to you like a worthless mess that just sold at auction for 50 million dollars is a Fire Letter Template that had been cast into a talusman by someone who had geometrically connected it to a combination of Keylons from ancient past that now represent such unthinkable power for the forces who continually seek your enslavement that it would be impossible to calculate. The prints made of that painting that now hang in a million houses, printed in 20 million books and magazines etc. would be automatically conjuring billions of physical Signets that exist and have existed for hundreds of thousands of years which are all now emanating the combined standing scalar waves reaching trillions of trillions of aether crystals. Owning such a master would be of an insane amount of prestige for that player within the ruling elite. Think of such works as the Mona Lisa whose frown recently magically turned into a smile right there while hanging in the Louvre. Which was all part of the Mandala Effect (renamed Mandela), because the curve of her lips connected to millions of other Fire Letter Commands predating her painting from the timeline now put into place would have been slightly curved, rather than just horizontal as our timeline had always shown on her face.

On top of this, the things that you consider are organic and just part of your world have all been turned into Keylons as well. Mt Rushmore, the Eiffel Tower, etc. included. Why do you think it is that while the planet you are on has supposedly been spiraling and hurdling through space seven times faster than a speeding bullet somehow manages to never lose the exact, precise placement of the Zodiac patterns (and countless other “constellations”) above it after thousands of years and not one of those planets have ever burned out and then fallen from the sky? Because they are entirely projected on the Atmospheric Membrane (crystal shell) by the Lunar Earth Command Module to radiate their patterns across every inch of this playing field on a continuous basis. And each group of patterns have also had symbols cast to represent them and names that can be transliterated and spelled out and symbolized with every language of the planet:

Decoding The Hive

creation of gravity, light, time and the god particle



This is how the **G.O.D. Program** has actually been played out all along. While it seems to us that those with the knowledge and ability to create Keylon Command Templates have been worshipping a being somewhere, such as the sun, moon, or a primal father sitting on a throne somewhere, they haven't. They use Keylons to channel energy from the aether using the subatomic particle energy to manifest their intent, just like making a talusman doll and sticking a pin in it to curse their enemies. Then they roll out the symbols they used in the construction of the Template and tell the uneducated masses "this is god", and then teach them to hand over all their creator-god powers to funnel that energy into that command template on their behalf. The masses think they are honoring some all-knowing god and are doing the right thing, while all along they are simply sealing their own imprisonment. By simply not believing anyone has any

Decoding The Hive

creation of gravity, light, time and the god particle

claim over your Sentience, you nullify all the Signets and Templates around you. Believe in **yourself** if you want to dissolve the Chimera Reality.

CHAPTER 28

LIQUID ELECTROMAGNETIC ENERGY



I covered some of the quantum nature of Deuterium previously, but as it is at the heart of gravity, so too is at the heart of free electromagnetic energy, as is oil, as are ions, as are neutrinos. It is a hidden element of surface-earth water not revealed to the public, and for good reason, because it is the graviton that has supposedly been eluding science according to their absolutely fictional claims that would attempt to explain gravity. Trust me, they know damn good and well what makes gravity, light, heat, life and time and how to mechanically reproduce it but no matter what happens, you are not supposed to find out.

Decoding The Hive

creation of gravity, light, time and the god particle

And why cover up the truth about gravity? Because you are supposed to continue to believe that space operates differently than it does so your confinement on the surface of the planet is permanent. All civilizations that ultimately move on to higher levels within the game reach a point where they either break the barrier between them and other worlds, or that civilization recycles and starts over again almost from scratch each time for a do-over. Think of these as schools where 40 children all enter together when they begin formal education and then grow up together from pre-k through high school graduation. By the time that group reaches the point where they are supposed to go on to enter society, either their education process succeeded or failed, producing either positive members of a functioning society or not, and generally arrive at that point on a collective basis. Some of those children will be more highly evolved than the collective, and if the collective fails to move forward, those select few will move on alone, just like some of the kids in your 3rd grade class skipped to the 5th, but the collective moved together as a unit. This will definitely be how this ascension process now will be working again, because only a few of you will have paid the price to educate yourselves so you can understand how the invisible steel bars are made out of pure light and are only supported by your belief that they are solid. Those who learn these hidden truths will be able to walk right through them as if by magic. Remember, magic only means something others don't know about.

QUANTUM MERKABA ENTANGLEMENT

In humanity's case, you are evolving here together as a unit, not as individuals. While individuals *do have* the ability to move on higher, they are sharing a collective mind with the rest of humanity, so each person's awareness level is linked to that of the rest of the evolution almost as if you are one person. This is something I will be covering more regarding in later reports because it isn't as vital to pass along now as these other issues such as gravity, heat, light, time and life (how things mechanically animate) must be clarified now. I have a lot of ground to cover and not much time to get there.

The fact you are all sharing one identity makes it very difficult for any single person to ever break out of the perpetual cycle that mankind has been going through for many thousands of civilizations together, thinking they are individuals interacting with independent entities around them. One of the things that humans consistently choose is to accept without question how things really work. You are handed answers in class, turn in your papers, and just like that you have learned how to parrot back to your teachers whatever it is you supposedly now know, and do so without asking the hard questions for some reason. When you are told that planets attract other planets to their symbiotic processions through mass that supposedly attracts smaller planets and that's what keeps them in the precise same patterns of orbit, you are being brainwashed into the paradigm of Isaac Newton's lie that replaces quantum entanglement with the fiction that somehow mass attracts mass. And while it might not seem like this is a big deal on the surface, it is. Because it is obviously incorrect, but you glaze over the facts without questioning how it is possible that in space mass attracts mass when mass doesn't attract mass here in your real world unless one is iron and the other is a magnet. Of course this is rare, and certainly does not encompass all rocks, all wood, all humans or all of anything else.

Decoding The Hive

creation of gravity, light, time and the god particle

Quantum entanglement is an interdimensional reality that exists across all veils and borders between worlds, because all things are alive, aware and connected at all times. The only things that are not connected to all other things consciously are the beings who come into mortal manifestation and their senses have been artificially diminished in order to keep them from understanding the bigger picture. Everything else already knows about everything and everyone else, because everything has an electronic sending and receiving antennae surrounding them wherever they go. It relays the message that this flower is *4 inches tall with white petals and a green stem and smells like honey* when you get real close to its bud, and it does so to everything within its own personal space if you will. Everything within its circumference of signal knows all about the flower, and then rebroadcasts that message to everything within its circumference. And since each thing; sub-atomic particle, rock, cereal box, parakeet continues to broadcast the message about that particle or flower to every single particle within all there is at all times, along with its own message about how tall that cereal box is, what graphics it displays, etc., along with that message, all things understand what is within existence:

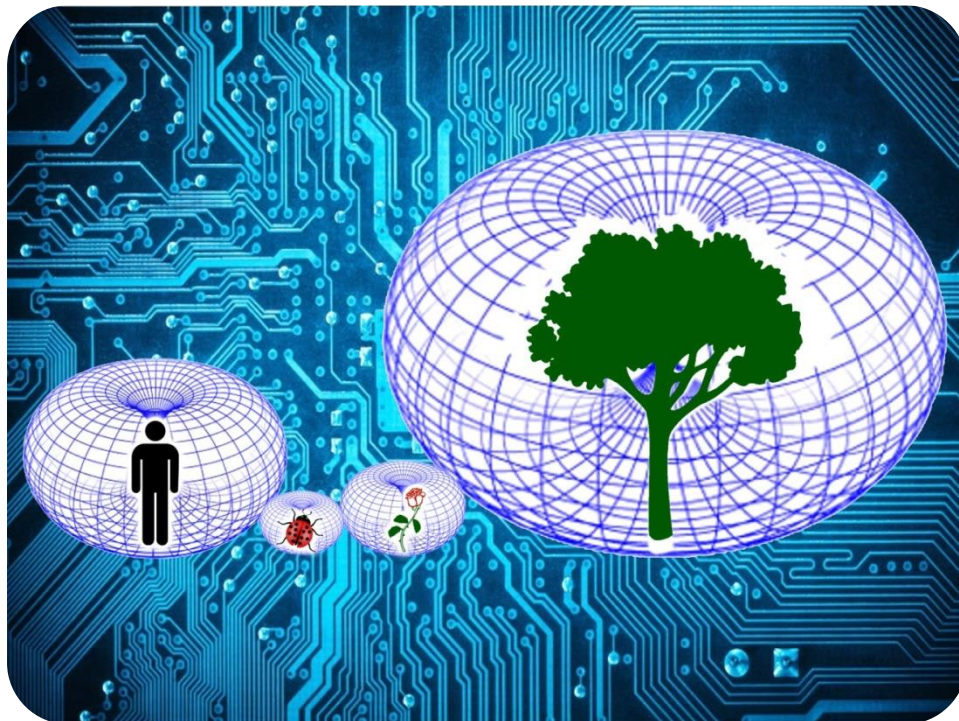

Since each particle within creation is multidimensional, it lives *in the future* as well as *in the past* and *in the present* at all times. This has been proven beyond **any** level of doubt to be factually and scientifically true as shown clearly in the **Dual Slit Experiment** covered in detail in reports already written that won't make it into this first two volumes but is set to come out soon. Time

Decoding The Hive

creation of gravity, light, time and the god particle

does not actually exist, therefore tomorrow and yesterday are eternally right now at all times. That means that every particle within creation knows what happened and is going to happen in the next instant, so the beacons broadcast by each particle or flower are sent out simultaneously at the same time on a constant basis, keeping all things within space and creation abreast with no time-lapse of any kind. Like your computer memory is updated constantly as your word-processor or graphics program saves your work, the memory of the cosmeias is updated constantly as well, no difference. The amneo-fluid Silicate Matrix (Aniline Krystal Seed Atoms hosted at all times by water) is the connection between each element of the memory-bank. Since you have been given the explanation about mass attracting mass regarding the planets, you are disconnected from this one incredibly vital piece of information. And with one single lie, you are cleanly cut off from understanding how *knowing* actually works on a physical level.

So the subject about gravity and mass happens to be more than just a big deal; it is a key piece of evidence in your arsenal in which to begin to break out beyond your atmospheric membrane and into the interstellar communities on your own at graduation. And this is, make no mistake, graduation day. You are either ready to enter the *real world* (cosmeias) or you aren't. And it is up to us to somehow explain to you very alien concepts about how everything works all at once in such a way as to get through the blanket of misinformation that has swaddled you since the day you were born. And do so incredibly quickly, giving you enough time to wake from your slumber, clear your head enough to process the information in time for you to make the decision about where you want to go next with conviction prior to the end of this incredibly narrow window of time you have in order to meet that deadline. The truths that will each one seem unbelievable to you will be coming at you in this paper at breakneck speed because we don't have 100 years to pass this along. We have right now, little more than 5 years' time, to break through the calcium that has turned into case-hardened steel surrounding your pineal gland and into your actual mind (your heart), so you can process it all fast enough. That won't be easy for you, and it certainly isn't easy for the Indigos who are here to bring you this information.

Energy, on this planet, works off of the Carbon Krystalline Model of creation. Crystals transmit energy, they store energy, and they blend every recorded event on earth within their genetic composition and pass that along inside of their quantum-entangled particles which together make up one complete picture of the energetic synthesis of what you think of as creation. I promised I would tell you how they are quantum-entangled (which I have just explained) and which *mind* is powering crystals earlier and here it is: Tara.

PLANETARY BODIES

While a **Host Planet** for **Dimensions 1, 2 and 3**, the earth itself is a being that is in its own personal 14th stage of this **15 Level Time Matrix**. During the final 3 stages within ascension, one drops the Avatar body of human-form, and **becomes a planet**. In the 13th stage you become a planet, in the 14th stage you become a host-planet (as earth) and in the 15th stage you take on the role of a sun, as explained previously. The form which you take on in these stages is dictated by the dimension you are in. A sun's composition is highly different than that of a host-planet. In this case, earth's composition is holding the form of a 1st Density playing field that hosts the 1st, 2nd and 3rd dimensions. It is a carbon-silica density where life is allowed to *grow this tall, be this*

Decoding The Hive

creation of gravity, light, time and the god particle

big and in the case of human Avatars *walk or run* but not *fly*. Each dimension you travel up to, allows you greater abilities so you don't come into manifestation knowing nothing about physics and how to handle your surroundings only to die the moment you take your first breath. You need to learn how to crawl before you can walk. And likewise, you need to learn how to survive in a world where you are able to run before you are given the chance to fly.

When the 3 stages of Density 1 are over, you graduate to a completely different *type* of playing field, where your body weighs far less, and it is *far* larger than in a carbon-silica frequency spectrum. Because of the vastly-reduced weight you will have, you will be able to take to air flight without facing imminent death the first time you run into a tree-branch and fall 50 feet to the earth below. If you toss a hummingbird out the second story window and it fails to flap its wings enough to overcome the gravitational PUSH of this atmosphere, it will likely land and survive the fall just fine, because its density ratio to the gravitational spectrum you are in is fantastically different than your ratio should you jump out the same window. In the 4th and higher dimensions with a pure-SILICA frequency spectrum, your body would react more similarly to the atmosphere there like a hummingbird would here, allowing you far greater chances of survival once given those greater abilities. This is because you physically change playing fields (planets) where the **Silica Model** is used for all three levels hosted there.

Earth is not limited to supporting life only within the lower Harmonic-1 Density of the 5-Density structure of the Time Matrix. She had hosted life originally in the 2nd Density (Dimension 4), but after her near-complete destruction 550 million years ago, was forced to drop down to the next lower level while she spent hundreds of millions of years healing, preparing to host life once again should she survive at all. As mentioned previously, the atmosphere there once hosted trees that were as much as 10 or more miles high, dinosaurs standing as tall as skyscrapers, human lifeforms as tall as 25 to 50 feet, etc. We have millions of proofs of the dramatic change in the size of lifeforms calcified in sediment showing this transition, so this isn't anything new. I am just putting it into context for you now. At the time of that transition from Host planet for the 2nd Density down to the 1st Density, earth was physically *far* smaller in size than previous, since most of her mass had been blown into space-dust. She was no longer able to host dragonflies half the size of modern humans today. All things from trees to bugs to mountain lions reduced in size proportionately along with the planet:

Decoding The Hive

creation of gravity, light, time and the god particle

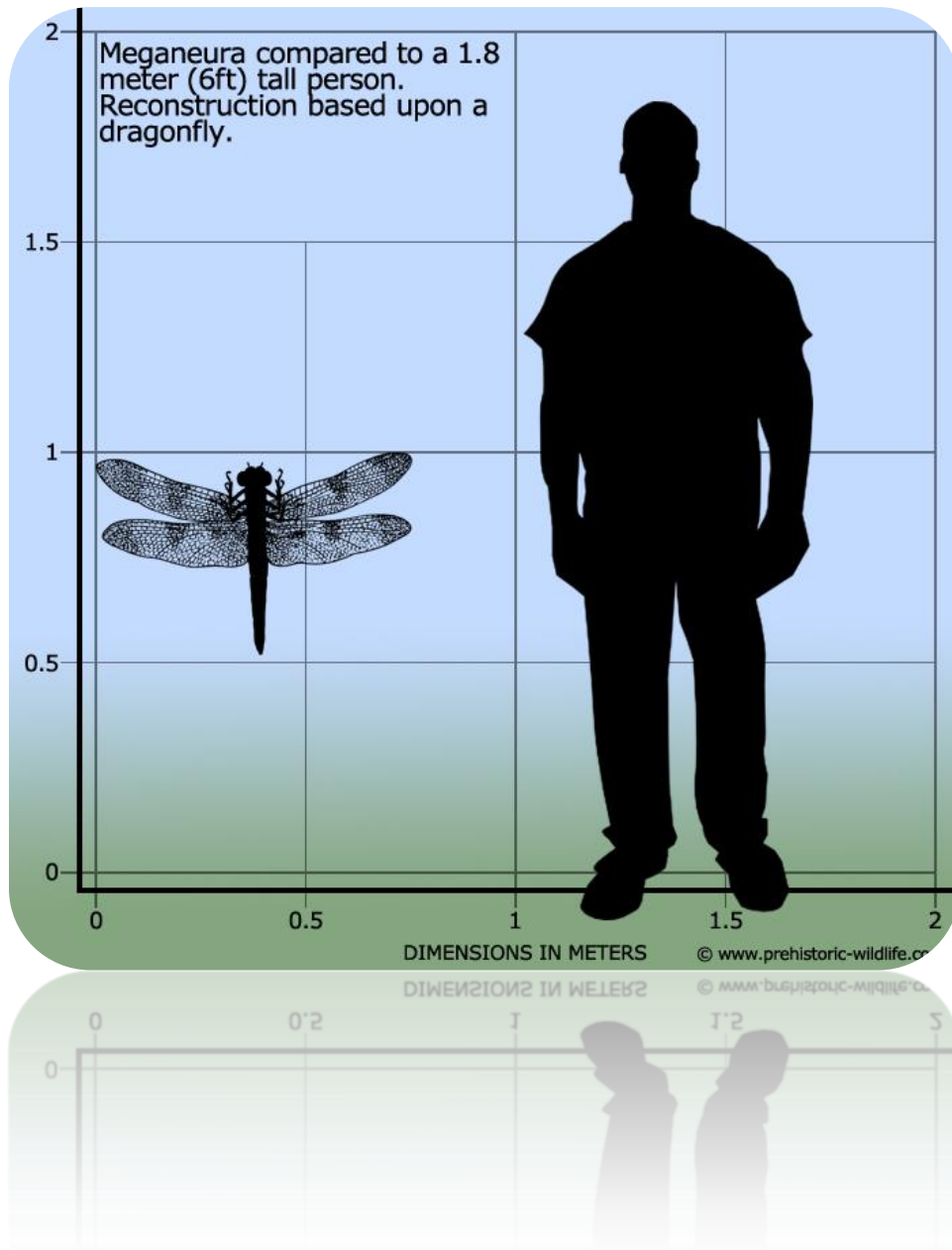

By the time the flora and fauna of earth began to take hold once again on healing Tara, she had already made the transition over to a carbon-silica *skin*, otherwise nothing would have survived on her body within this density that was far lower in frequency harmonics than where she had come from. One of the details making up his transformed composition was the growth of carbon-crystals. These crystals grow exactly like a flower, just in subterranean environments. As they grow, they shed tiny particles of their form which become water-born, air-born and also Deuterium and oil-born. Science calls these elements *liquid crystal*, but you can see for yourself that they collate back to the shape of their Keylon Grid pattern when flashed into solid through freezing as Dr. Emoto has done many thousands of times in order to see what their structured shape is. The liquid isn't crystal, but the ultra-tiny Aniline particles inside are, and they are

Decoding The Hive

creation of gravity, light, time and the god particle

carried by that water, allowing the Aniline silicon crystal (ceramic shell) to provide insulation between each energy cell so they don't just short-circuit. When a large enough group of crystals come into the Merkaba field of each other to form a single drop of water and they are then frozen, you can see that their quantum-entanglement reverts back to their cellular mission structure or their Signature. Maybe you can guess what it will be:

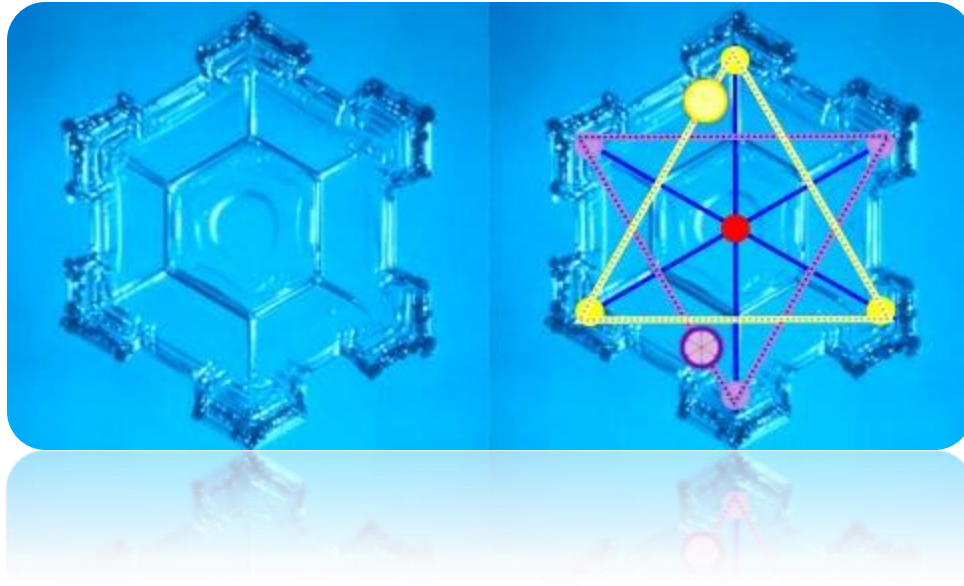

Of course you know by this time that liquid crystal is merely a way of stating there are millions of tiny crystals inside a cup of water and due to their size, they seem like they are liquid. But the crystals themselves are not, they hold the form of a solid and water is their transportation vehicle.

THE LIE OF FOSSIL FUEL

Don't think for a second I am the only one who knows that water is filled with electromagnetic energy. There have been inventors too numerous to mention who have shown that water IS the ingredient inside gasoline and diesel that is actually burning when certain elements have been added as an oxidizer (oxygen), *not* the fossil fuel itself which is merely the "match" that ignites the ion energy held in the Aniline crystals to release that force.

In diesel fuel, 80% is oil, 1% is an emulsifier, and the rest is water. It has repeatedly been shown that the fossil oil is not necessary for the engine to run, but is added as a filler to create the illusion that fossil fuel is needed. When the crystals held within the water is released as energy, the **oil that burns off** turns into smoke and is emitted into the atmosphere as pollution while the liquid carrier of the energy dribbles out the exhaust pipe in the same condition it was in before because the water is a delivery vehicle. Water never turns into pollution, regardless of what you do to it. It can become saturated with pollution, but the water remaining is still the life-force essence of material existence because it is able to deliver the energy of the crystal into every crevice of existence. It is the salt in the water that that carries this energy, so hydrogen-powered engines must have a stainless steel exhaust manifold, otherwise the salt will begin to dissolve

Decoding The Hive

creation of gravity, light, time and the god particle

lesser steels and metals in the form of rust. In every case of using water as fuel, the exhaust manifold must be stainless.

It might seem on the surface like oil is powerful enough to burn even if there is water mixed in with the gasoline you buy, and your friendly petrol man is merely cutting the gas to stretch his inventory to make an extra dollar. But this isn't the case. Water *has to be* in the gas in order for it to provide enough power for the car to propel itself. And as you can see with 80% diesel and 19% water, it takes a lot of oil to do the job of providing enough heat to even make the equation work at all. Because what the oil is actually doing is stepping up the spark's temperature high enough to ignite the crystal in the water because a simple flame is not going to reach the 2200-degree-plus temperature required to separate the natural insulator of water away from the hydrogen molecules that provide the burnable fuel. As already pointed out, NASA doesn't put gasoline in the space shuttle, it puts solid rocket fuel onboard which is frozen Deuterium. The simple process of separating H (hydrogen) and O (oxygen) particles from liquid water is done in what is called a *Solar Water Cracker* which uses the frequencies of the sun instead of the 2200-3000 degree-heat it would otherwise require.

What hydrogen actually is, is the Aniline ion energy already removed from the liquid amneo water. Even though there are many inventors (some shown next) who have definitively demonstrated that water is full of hydrogen which can power a car or other devices, and there are ways to cause it to combust in regular engines, they are missing the point that hydrogen is pure electromagnetic energy. Rather than forcing it to combust, as oil is used to do today, all one has to do to coax the ions out of water is add salt which overrides the insulating effects of the water, making it into an electromagnetic conductor, such as the Egyptians did with the Baghdad Battery.

One scientist after another down through recent history have announced they can run engines on water, only to be imprisoned or mysteriously suicided days or weeks later. Indeed, one of the biggest conspiracies against human life is that cars and trucks need fossil fuel. It isn't enough to hide from you zero-point free energy, you must also be hooked up to the meter of fuel you can't make yourself in order to perpetuate the garnishing of your hard-earned wages, while destroying your entire world in the process. Here are only *a few* recent water-powered engine breakthroughs never to see the light of day:

Herman Anderson (1918-2004) – Herman had an illustrious career as a scientist at NASA testing hydrogen powered rockets. He used this knowledge to create a water-powered vehicle which he believed would transform the world. He was banned from producing the vehicles due to their creating "radiation" which was equivalent to or less than every other vehicle on the road:

Decoding The Hive

creation of gravity, light, time and the god particle



*In 2008, a Japanese company called **Genepax** unveiled a water-powered car. They received a patent for the vehicle in Japan and demonstrated it to the press. The car is extremely efficient, able to drive at 50km/h for an hour on a litre of water. It runs on virtually any form of water too, even tea and soda. Immediately following the unveiling Genepax announced they would not be producing the cars for various reasons:*

Decoding The Hive

creation of gravity, light, time and the god particle



Stanley Meyer (1940-1998) – The most famous water car inventor to date, created the “water fuel cell”, claiming that any car fitted with it could run purely on water. A local television station filmed him driving a dune buggy powered by the device and soon after, he and his brother Stephen met two men at a restaurant who claimed to be potential investors. After drinking a sip of cranberry juice, Stanley grabbed his neck and ran outside. Stephen recalls, “I ran outside and asked him, ‘What’s wrong?’. He said, ‘They poisoned me.’ That was his dying declaration.”:

Decoding The Hive

creation of gravity, light, time and the god particle

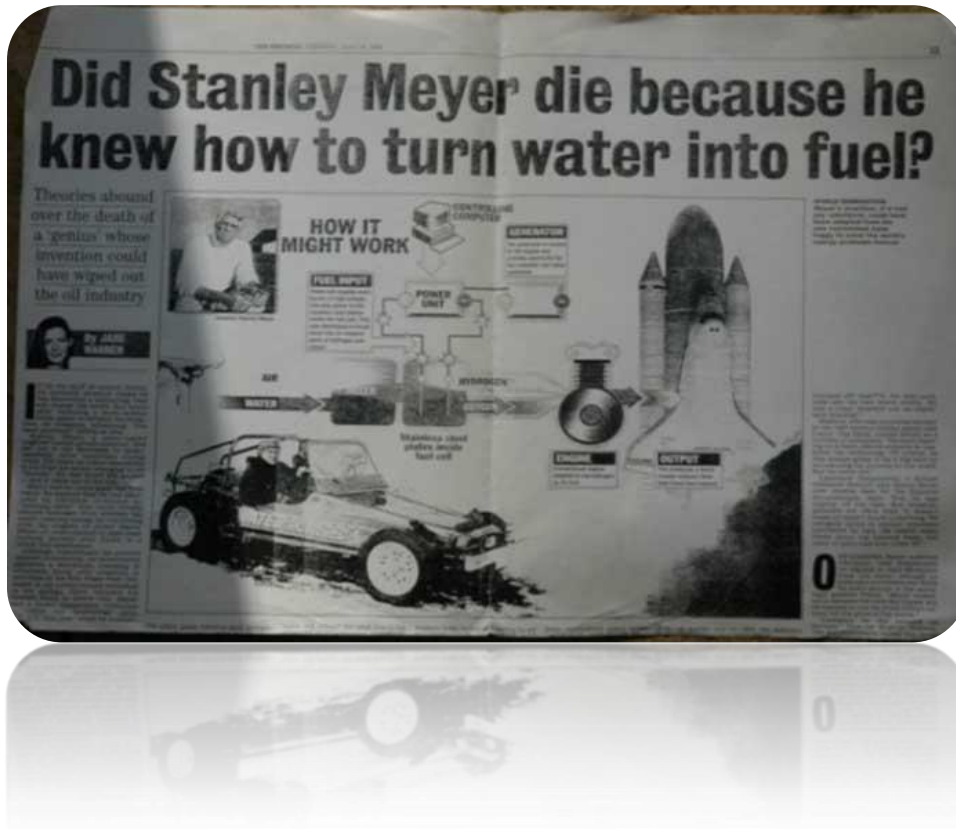

Steve Ryan's water powered motorcycle – In 2005, "60 Minutes" featured the inventor Steve Ryan demonstrating his water-powered motorbike. The footage shows Ryan fueling the bike with just water and then driving it 50mph along a highway.

*Ryan's firm, **BiosFuel** was planning to sell motorbikes with the conversions in them. However, the company went quiet before announcing, 'Due to political and economical reasons, we are unable to sell the motorcycles.'*

Decoding The Hive

creation of gravity, light, time and the god particle



The Joe Cell – An Australian man, only identified by the name of Joe “X”, designed an Energy Cell that utilizes water for a fuel, with various prototypes recorded on amateur videos recorded in Australia from 1993-1997. Joe X was the victim of threats and harassment that succeeded in stopping him talking. However other researchers have taken his videos and manuals and continued to build the device:

Decoding The Hive

creation of gravity, light, time and the god particle



Bill Williams studied the Joe X tutorials and claimed that he was able to power his truck using the fuel cell. He shared his findings with a group of fellow enthusiasts online. Then, in 2006, Bill posted this on the group that he was approached by two men with guns who knew the hours and location of where his kids worked, his wife's working hours, his grandkids' school, etc. and if he didn't stop working on the water car there would be consequences. He was also instructed to destroy all his work, cells, drawings, lab journals, and everything connected to it immediately."

Decoding The Hive

creation of gravity, light, time and the god particle



Paul Pantone (shown above) Thegoodsurvivalist dot com: “Paul developed a small engine that runs on 80% water plus a variety of other things (and yes, it works). In the year 2000, Paul Pantone was offered many millions of dollars to sell off his rights to GEET. Allegedly Paul was taken to court and it was argued that he was insane for turning down an offer for such a large sum of money. Paul was eventually placed in a mental hospital and was pressured, and tortured to try and force him to sign over his patent. Paul Pantone was railroaded through a series of bizarre legal maneuvers by powerful and corrupt conspirators into a State Mental Hospital in Provo Utah where he resides today. He’s supposed to be incompetent for claiming that one can fuel a car with mostly water using his system and for not getting along with fired attorneys under Utah Code 77-15-5(4-5) who betrayed him. Never mind the over 200 GEET devices in the US currently running on mostly water.”

But water power isn’t the only thing that has been held back, as mentioned, zero-point antigravity has been the main thrust behind the lie of fossil fuel all along, because not only does the air around you contain all the energy anyone would ever need for any application, but it would also allow for silent, unlimited travel over any terrain which would never need new tires, fuel or mechanical repairs because it would function entirely off of magnetics that does not deal with friction issues. The energy that powers such crafts is the exact same energy being tapped with hydrogen vehicles, but zero-point skips completely over the messy issue of burning it in order to release the energy:

Decoding The Hive

creation of gravity, light, time and the god particle



*Jimmi Heseldon purchased the Segway company in 2010. 1 ½ years later and just 1 week away from releasing for sale to the open public a self-balancing hovering Segway (no wheels), he was murdered. This is not public knowledge, so it will not be possible for you to verify this report. Council informed me of how zero-point technology nearly reached the public in 2011 but was again thwarted by the petroleum syndicate. He was pushed off of a 65 meter cliff while out on one of his machines just days prior to the unveiling of the **Segway Hover** which was already fully developed and actually in production preparing for the tremendous demand the company knew would follow the press-release. All prototypes of the first anti-gravity transport device designed for the public were confiscated and the assembly-lines were shut down.*

Decoding The Hive

creation of gravity, light, time and the god particle

Anti-gravity has been in use openly across the cosmos for trillions of years and for decades here on earth in many forms including the subterranean **Supersonic Magrav Shuttle that** connects both continents of America with just a 27-minute ETA from New York to Los Angeles. The US is not the only country to employ the Magrav Shuttles reserved only for the ruling elite. They are the reason the **Concord SST** (supersonic passenger-jets) were shut down in 1978, because they were obsolete. The Magrav Shuttle is 4 times as fast without disconnecting the passengers from earth's support field and without using a drop of fuel. This is a smuggled photo of a nuclear tunnel-boring machine extending one of the routes for the Magrav:



I could go on and on with examples of free-energy devices that have surfaced recently only to see the inventors silenced or suicided, but this is only to show that the crystals carried in different forms of water is the secret that is not only the power source for life, it is the power source of zero-point energy *across the spectrum*.

DEEP GREEN ENERGY

There is a company, **Deep Green Technology** that creates electric generators using no gears or moving parts from nothing but the tide of the ocean and the water in it. They explain this at the start of their webpage with the photo shown below to indicate just how it works. I post this here to illustrate that not only is the electricity there, but the way their device functions to create "1000 times more power" is by harnessing the invisible flow of the creation of electromagnetic energy at work in the ocean currents I am sure they know little if anything about other than *something is making magic down there*:

Deep Green Technology

Decoding The Hive

creation of gravity, light, time and the god particle

*“Imagine that you are standing on a beach flying a kite in the wind, you feel a strong force from the kite in the rope and notice that the kite flies fast, way faster than the wind is blowing. If you would attach a turbine to the kite and put it in the ocean, where a water current flows instead of the wind blowing, you would have the concept of Deep Green, Minesto’s power plant. The secret behind Deep Green is that it reaches a speed 10 times higher than the water current, just like the kite flies faster than the wind. The speed has a cubic relationship to the power; ten times higher speed gives **1000 times more power.**”*

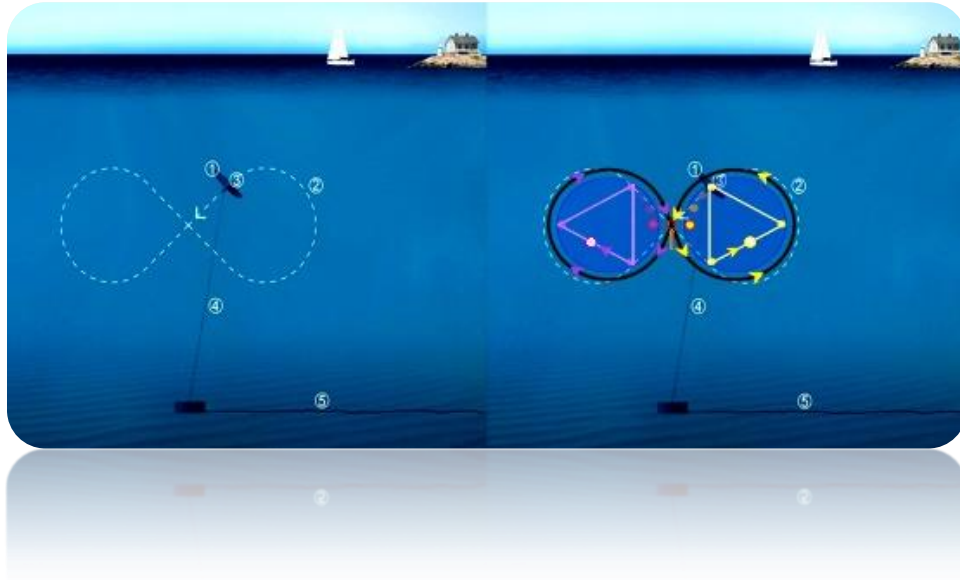

“The water current creates a hydrodynamic lift force on the wing which pushes the kite forward (1). The kite is steered in an 8-shaped trajectory by a rudder and reaches a speed up to ten times the water current speed (2). As the kite moves, water flows through the turbine and electricity is produced in the gearless generator (3). The electricity is transmitted through a cable in the tether attached to the wing (4). The electricity continues in sub-sea cables on the seabed to the shore (5).”

CHAPTER 29

GRAVITATIONAL PUSH



Gravity does not come from mass, as mentioned earlier. There is no such thing as mass, so there is no such thing as gravitational pull. This is an illusion to make you believe in the incredibly ridiculous lie that our planet is being held in a procession around the sun because the sun has more gravity than earth, therefore is locked in this constant state of circumnavigation of its orbit. If you can demonstrate how a larger rock attracts a smaller rock, then by all means tell me your theory. The explanation you are about to read is not a theory, I am showing you how gravity is created.

The current scientific community uses many illusionary claims to support their flawed course of reasoning when it comes to energy. They attempt to convince the public that the sun is a burning ball of fusion (which we have established as impossible due to the fact that Deuterium Aniline crystals must be present in order to release oxygen to support any kind of kinetic incineration), but they have to support their claims using something that would appear to have some line of

Decoding The Hive

creation of gravity, light, time and the god particle

logic in order to pull off their brainwashing campaign. As I have repeatedly shown, they will change the name of one thing into this other name, to this other utterly unconnected material, change the name again, and then change it again, like an illusionist that whips the ball from one cup to the other back and forth until you can no longer piece the trail back together to know if it is under CUP A or CUP B. Keep in mind that Hydrogen/Oxygen is a major component of water particles called Aniline which are too small to see without a microscope. I am about to tell you exactly how it is that their claim is sort of true, but *off by about a million miles*, according to their own science:

From electropaedia dot com: Nuclear Reactions;

*“In the chemical reactions associated with combustion, the atoms in the molecules of the active materials rearrange themselves into new, more stable, molecules in which they are more tightly bound and in the process, releasing surplus energy in the form of heat. In this case the energy released by the reaction in the form of kinetic energy and electromagnetic energy [**gamma radiation** which means “change” from one type of particle to another] is millions of times greater. Positron Decay - A **proton** is transformed into a **neutron** by **losing** a positively charged positron and a neutrino leaving it with no charge.*



*It is **positron decay** which initiates **the Sun's nuclear fusion**. A Hydrogen atom (proton) is transformed into a neutron which then fuses with another **Hydrogen atom under the Sun's conditions** of extreme temperature and pressure to form **Deuterium** an isotope of **Hydrogen**. The Deuterium nuclei undergo further fusion reactions to produce Helium with the release of huge amounts of energy.”*

By now you know what a Proton is (+), and a Neutron is (-). By introducing the illusion of HEAT surrounding the activity of the sun, they can convince you that the force of the HEAT is causing the transformation of the Protons (full gas tank) to Neutrons (empty gas tank). And that would all be fine and dandy if the sun caused heat, but it doesn't, and I have shown you the proof of that. What I am about to explain will show you where the heat is created, how it is created, and what “positron decay” actually is. Here is a hint, remember that **ALL THINGS** work in cycles and that **ALL THINGS are ENERGY** including neutrons (because a neutron is ½ of the whole it is actually made up of, the other half being protons that are merely transitioning back to positive energy which is called negative (-) in this black-is-white world):

Einstein:

“Energy cannot be created or destroyed, it can only be changed from one form to another.”

The above statement, even though it had been coined by the greatest scientific deceiver of modern times (much later after Hermes had set the ball in motion), the Einstein Illuminati Program, happens to be true. No particle of energy has ever been shown to become depleted, it always transforms into a different type of energy particle, regardless of how much work it had just performed. If you run a mile, your body is hot, and emits heat into the atmosphere, the

Decoding The Hive

creation of gravity, light, time and the god particle

atmosphere heats up around you and that heat then evaporates water which releases hydrogen (energy), and oxygen (which makes the energy release heat) from the Aniline crystals, rises higher (lifted by the hydrogen), then turns into a cloud that rehydrates through dew-point condensation (the heat attracts water which then cools down and collates back into liquid form once again), dropping the water to the ground which fuels the trees to grow leaves which fall that then powers the soil to grow more trees. No matter what scenario you use regarding the expression of energy, you can never show it to degrade or decay, but only transform. So the words they use to illustrate that transformation will *lead* your thoughts to assume they mean **die** or are **spent** when they say *decay*. Positron Decay, by their very own explanation above, literally means *change*. Decay is presented as a direct synonym for *deteriorate* which energy can never do; therefore the word play itself is part of their program. You already know by now there are reasons for this word game.

They also mention above that “*Deuterium is an isotope of hydrogen*”. **Isotope** means simply the count of neutrons is *different* than the count of protons, that’s all. Instead of saying “this molecule is *heavy water hydrogen*”, they change the name completely to something unrelated so the breadcrumbs are missing. All you have to do to make Deuterium into hydrogen is **add sun waves**. That’s like calling cola syrup *Polyfluorineseptatium* before it’s had a shot of seltzer.

The reason I am making these distinctions crystal (no pun) clear, is because they are using all sorts of names for the same things and all sorts of terms to lead your conclusions so you are unable to see for yourself what is really going on. The standard protocol for science is to use terms such as decay, which means *death* to us, for transitions that literally mean *resurrection* and the negative connotation is then complete within our understanding. A person would never imagine that positive (+) energy literally means **dead battery** and negative (-) literally means fully charged and ready to go, but that’s exactly what has happened within the scientific narrative. The electron is a negative particle (-), yet it carries the *strong force* of the atom, so you do the math.

WATER TYPES

Water-terms used by science distinguish the difference between ocean or sea and surface:

- DEUTERIUM is *heavy water* from the lowest point on earth, the bottom of the ocean
 - In truth, that heavy water virtually fills the core of earth as well, sharing that space with oil. Oil is the ultra-condensed **carbon battery** and water is the more fluid version of that energy that can permeate more of the particles of earth than oil is able to do in such a condensed energy form, which allows the water to escape the core and the oil to remain within the circulatory system of earth where it is needed
- SEAWATER is water in the main portion of the ocean
- SURFACE WATER is river, lake, creek, or the top fraction of ocean water

Decoding The Hive

creation of gravity, light, time and the god particle

- There are many other names given water I won't bother you with, but these are the main elemental water categories. Surface water is not the same thing by any means as seawater, because of the very high energy in the salt contained within the ocean, the bulk of which must be removed before coming into contact with surface life

Surface water goes through what they call *transpiration* (another name to make you think the water has *died*), then *evaporation*, a term to make you think that the water is now *gone*, then through sublimation (creating a cloud), and suddenly the water magically reappears as rain out of absolutely nowhere. They contend that what is between transpiration and rain is merely air, or the complete lack of anything physical. This is not true. Heavy water (liquid crystal), seawater (thinned-down liquid crystal), surface water (liquid amneo fluid with low levels of crystal), air (thin water), clouds (reconditioned liquid amneo fluid), thin air (very, very thin water, hence extremely low volume of oxygen content) are all water, but just in differing degrees of the one cycle water makes which is the invisible electric cord that plugs in to all life just like your heart circulates blood cells that power every element of your body.

HEAVY WATER GRAVITONS

At the beginning of this disclosure, I showed a photo of the calcium deposits left over when liquid water is boiled down, leaving only white powder behind. That sediment is made up entirely of Aniline crystals. What I didn't show is the difference between seawater boiled down, as compared to the water that falls down from the clouds. Cloud water or meteoric water (which is what we call surface water) must go through evaporation or *distillation* in order to reach the cloud cover, recycle the gasses back into liquid form, then distribute the energy held inside the crystals back down to earth to reach surface-life. The initial evaporation process leaves behind the vast majority of Deuterium crystals (Aniline capacitors) right there in the ocean and then brings only a few up into the atmosphere where they cast out light and heat while distributing oxygen. Those Aniline capacitors are the hidden gravitons science continually keeps "looking for" in all their god-particle experiments. And of course those at the top already well know this, but because the math that is handed to the scientists is coded to keep Alinine's true identity a secret through hexes and spells cast across their scientific names, symbols and titles, it remains the *holy ghost*. While under a spell to make something invisible before your eyes, what is actually there simply cannot be seen, even if it is biting your leg.

As you will see, the capacitor crystals inside the liquid Deuterium distribute different levels of energy as they travel up through their complete cycle, with some ending up as part of the atmospheric membrane. But the liquid itself called amneo fluid is what *distributes* gravity which is also gradient in its dispensation. We assume gravity is constant while on the planet, but this is clearly not so, as the forces of gravity differ vastly between the ocean floor and the Troposphere. The liquid portion of Deuterium is conjoined to the plumage of the Aniline crystal, but goes through phases where it begins as ultra-heavy from the ions carried in the crystal, then it gets lighter as it gathers more hydrogen/oxygen and travels up higher. This is the same calcium crystal I showed you at the beginning of this report, only zoomed-in close enough to see that Aniline takes the shape of something like a feather that will hold not only the **oxygen energy**

Decoding The Hive

creation of gravity, light, time and the god particle

inside, but the hydrogen particles can lift it into great heights with little effort. And you will never guess how your captors symbolized Aniline in your country's **Command Signet**:



And the little spikes at the end of the arrows on the left which are actually little clusters of Aniline crystals as shown on the right, are also shown in the ancient hieroglyphs as coming out of the sun. Perhaps they knew something about neutrinos and ions back then? Of course they did, as their monolithic structures make it perfectly clear that modern man has no idea yet how to harness real energy:

Decoding The Hive

creation of gravity, light, time and the god particle



Once Aniline goes through transition at the surface level, gravitational push transitions from pushing oxygenated substances UP, to pushing them DOWN. And the higher into the air it travels, the less PUSH it applies, as will be explained in much greater detail. This can be measured in **PSI** or pressure per square inch, which I will show in a moment how that differs depending on how much water (weight) has been separated from the Aniline crystals through greater evaporation as it continues to rise. I make this point now before we get into the physical science of how water amneo fluid actually works, to make the distinction that Aniline is technically a graviton, but not all of its particles work AS gravitons throughout this process. The upshot is, wherever there is water, there is gravity. There may not be life, light or heat, but gravitational PUSH will *always* be present.

THE GRAVITON

When the sun's frequencies (invisible waves) strike the surface of the ocean and begin the process of evaporation/distillation (by unlocking the energy held inside the crystals which creates heat and light), it infuses the resulting gasses (thin water) with hydrogen/oxygen (HO) which provide lift. The HO doesn't have enough pull to bring vast amounts of super-heavy Deuterium crystals with it, so the process of bringing *surface gravity* into the atmosphere above sea level is

Decoding The Hive

creation of gravity, light, time and the god particle

precise, distributing those gravitons evenly from that level upward, while the gravitons that are condensed in the ocean keep the liquid (gravitational pressure) concentrated within the basin.

You can do your own test right now on your kitchen stove. Put a litre of water each into two pots directly from your tap, and add 1.2 ounces of salt to *one* of them to equal the same amount of sodium chloride found in the average ocean or sea, then boil them both down until the bottom of the pans are dry. Better yet, use real sea water if possible, but it will still be the same results. The salt that you added to the one will still be found on the bottom, and now in the form of calcium, whereas the other will be just lightly white from a small amount of residual salt. Seawater will leave many times as much calcium behind when boiled off than rainwater will. Of course, you can then take that calcium, crush it under the bottom of a spoon and sprinkle it right on to your fries because it is still salt and what was left behind was left on purpose because gravity concentration must be far higher in levels at and below sea level than above for the whole process to work to separate atmospheres within a multi-level playing field.

Salt in water causes buoyancy, while the liquid of water condenses the pressures provided by the Aniline graviton. Therefore when in salt water, your body is being forced **upward** to keep you at the surface, not down close to the bottom of the ocean where other species of beings make their habitat. Earth does not house just humans, but many species that are meant to remain separated. Much more on this later.

REENERGIIZING DEUTERIUM GRAVITONS

Illustrating how this works is complex, because earth is not simply a ball, and it's not simply an oblate spheroid, it is a multi-dimensional platform that hosts trillions of different worlds within the exact same space, separated only by frequency. Sounds that are audible to you may be limited, but there is no such thing as sound being limited in what can be generated, meaning there are no limitations to the veils that can sustain other worlds. There are repulsion zones at the center of earth, as well as at the surface along with many levels in between called life zones, each one hosting a different group of creatures. Some of those creatures are meant to intermingle with each other in overlapping zones, and some aren't. In very high-mountain regions there are multidimensional beings that have always been there above elevations where humans no longer are able to breath the air (see **MODERN AQUEOUS PYRAMID CITIES** in the chapter **Scalarwave Signet Energy** in our next volume for more on these species). There are also repulsion zones at the equator that separate the two-halves of the one playing field. We think of this as an oblong "ball", so I will show you in "ball" terms what it acts like, but you will have to think spatially in order to follow along to understand how the event horizon of earth works while hosting millions of additional program templates that work symbiotically with that foundational or **KEY** template of the planet.

Here is how the immediate human life atmosphere regenerates. Notice the flow of the atmosphere travels in a sphere; this is because the Keylon Template functioning at the surface level has its own Event Horizon that creates a life zone in this region:

Decoding The Hive

creation of gravity, light, time and the god particle

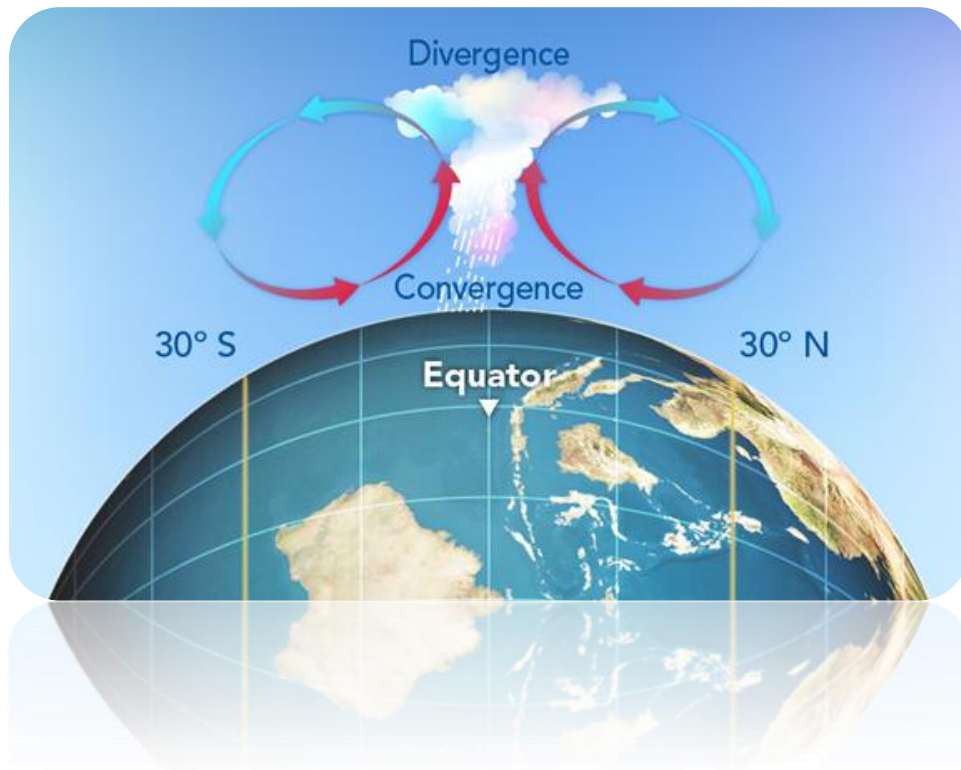

At the same time, it also regenerates on a larger scale as shown here, where the surface of earth is a repulsion zone at the half-way point of the Keylon Grid Template. Technically I need to be showing you the inside $\frac{1}{2}$ of the planet, and the outside half which includes a large portion of what we call space that are separating veils keeping humans on the surface below with increasingly-harsh repulsion forces. But this will give you the idea. The bottom half (inside the planet) is the portion of the template where energy is brought in to power the upper half or *outside* of the playing field where you are allowed to move about. Imagine the top portion of the Keylon Template at the left as the dome or the atmospheric membrane (which is much larger than this illustration), defining the middle-point (playing field) and both extremes at the top and bottom of the sphere. You can move a small distance from the surface each way, but unless your technology dramatically increases, a fraction above and a fraction below is where you will remain:

Decoding The Hive

creation of gravity, light, time and the god particle

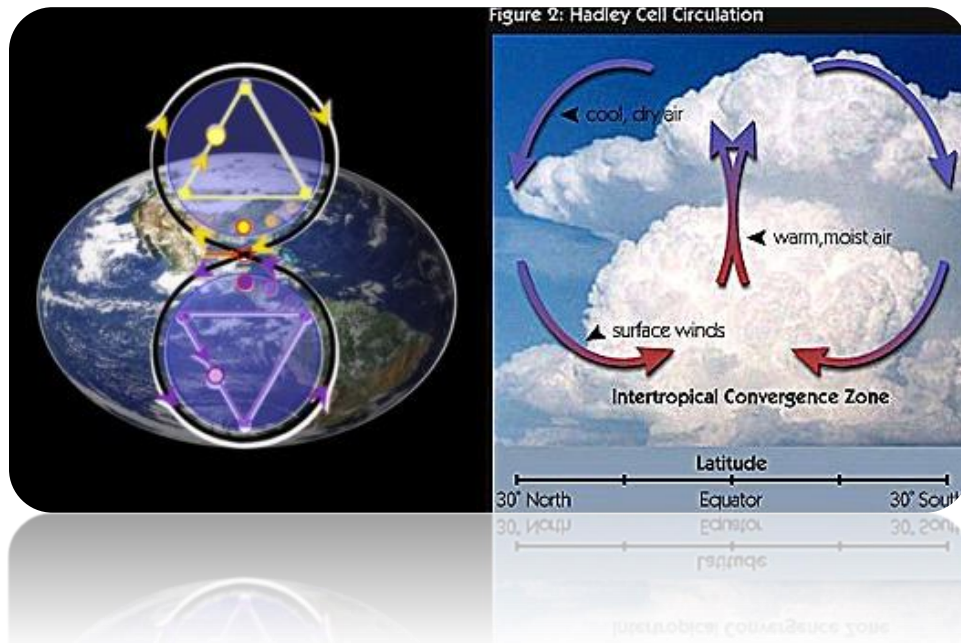

Notice the Hadley Cell circulation illustrated on the right, showing you how at certain distances from the absolute middle of the reality field (top circle on the left, or manifestation side of the event horizon), our breathable atmosphere regenerates. It processes our amneo fluid (reliquifies the water gasses) within the cloud cover in order to distribute the energy evenly across the entire planet. Sometimes the friction of counter-circulating water striking against the oncoming water particles super-charge this area through static electricity causing lightning bolts which recharge portions of the **Krystal Cathedral Energy Grid** within the mantle of earth below as I understand it at this time.

The only thing that can 100% avoid the lift of oxygen (the particles that fuel hydrogen) is large concentrations of pure crystal (like sand particles or larger) and other material devoid of all oxygen molecules (rocks falling from the sky wouldn't be very conducive to the humans at surface level). At the equilibrium point of earth (called surface or sea level where density weighs at **equilibrium**), the **Liquid Silicate** (water amneo) begins to repel oxygen greater and greater as you reach closer to the edge of the Event Horizon of the top half of the Keylon Grid of the playing field. A human body floats in water due to the oxygen content it must carry in order to remain at the equilibrium point with the correct amount of gravitational push, while a stone (no hydrogen/oxygen content) will travel effortlessly to the bottom of the ocean.

As mentioned in a previous chapter, celestial energies in the form of ions and neutrinos flood earth on a constant basis, delivering energy to the life force of the planet. They are multidimensional particles, just as all photons and therefore travel through earth's crust, strike the oil (carbon capacitor particles), and recharge the *ion battery* that is below the surface or mantle. Oil is similar to the amneo fluid water within the life field, in that it is filled with microscopic crystals, so therefore it is by its own organic nature a liquid battery. Even though oil is thicker than water, it weighs less, because it is not as dense or compact as water particles. Thus, it floats to the top of the heavy water below the mantle, forcing the water that is ever-increasing in

Decoding The Hive

creation of gravity, light, time and the god particle

oxygen and ever-rising upward to pass through the oil, which creates the **SET** or Static Electrical Transfer, recharging the crystals in the amne fluid Deuterium water in order to then transfer that energy to the life-field above. Once the heavy water has been recharged, it seeps into the human playing field through the mantle where it remains at the lowest possible elevation it can until it is activated for release into the upper ocean and ultimately to the atmospheric membrane itself above the Troposphere. Oil remains below the mantle because its density is too thick to simply permeate the soil that separates the life field from the energy-plant below:

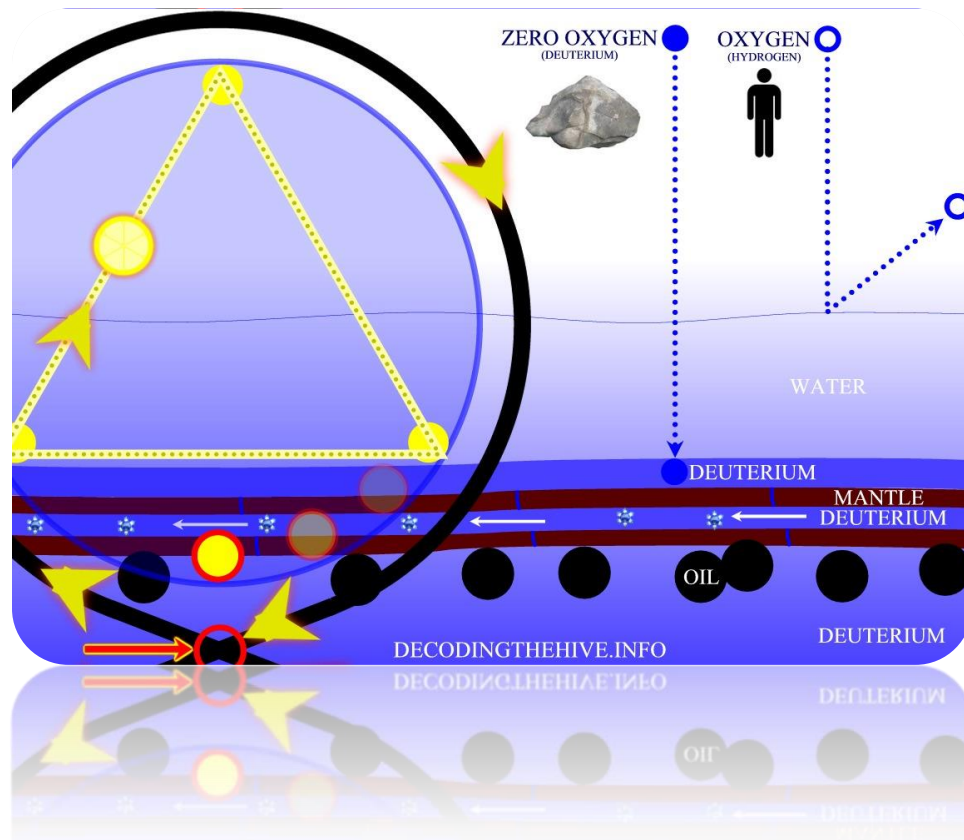

Pure Deuterium Oxide (virtually zero active oxygen particles), once blended with **oxygen** is renamed **water**. **Water** blended with even more **oxygen** is renamed **hydrogen**. Hydrogen never stops pushing **upward** until it loses all oxygen particles and reaches its event horizon where it then begins the process of turning back into Deuterium, then never stops pushing **downward** until it reaches the lowest point of its opposing event horizon where the entire process begins again as heavy water. Deuterium gravitons exist from the edge of the Atmospheric Membrane (firmament), down to the core of earth, just carrying varying forces that support the many different densities of beings that share earth-space together.

Deuterium cannot be compressed under heat or pressure to condense it (within ordinary applications. All things can be compressed to some degree, but heavy water, similar to regular tap-water resists compression to an extreme level, resulting in it being referred to as incompressible). The reason why it is only water that cannot be compressed within this playing field, is because the Aniline Krystal Seed Atom is made up of multidimensional Sentient beings

Decoding The Hive

creation of gravity, light, time and the god particle

that take form to serve as the hosts of the hologram, we call the aether. It can be considered the one thing that is the most physical within this holographic reality, or the one constant, and most likely why the Elohim have made it a passion to represent themselves here as “the god”, “the one” eather. It is their intention to make you believe that the aether doesn’t actually exist, but they and only they do when it comes to determining your life’s journey. When material, such as carbon is put under the highest pressure possible, eliminating all other substances, filtering it down to its core existence, it will be Aniline that takes the shape of the diamond.

While Deuterium is found in all forms of water, its content is very low once it has been distilled (evaporation/rehydration), and what is left after you strain or filter water that is still liquid is Deuterium that is void of almost **all** oxygen content. You can **create** Deuterium (heavy water) simply by burning water until it will no longer produce flame (yes, water does burn at the right heat above 3000f, and I do not mean evaporate, but the oxygen/hydrogen in the water once burned off, leaves heavy water Deuterium behind). This simply means that Deuterium is the **base** of water, and tap water is the oxygenated version of this hyper-unique liquid. Only the sun’s rays (or emulated through heat) will completely separate water from Aniline, and even then the liquid water remains in the auric field around its companion crystal in the form of gas.

Aniline crystal that I call the graviton is in truth only half of the actual true “graviton”, as Aniline crystals must be surrounded by some degree of liquid amneo fluid (water) in some form in order to generate the symbiosis that actually works to produce what we call gravity that I call *gravitational push*. Realize that Deuterium is a composite, or a combination of elements. Together the ingredients function as lift, energy, water and oxygen (which is the oxygenator that provides the match to the fuel of hydrogen). Any time water is present, whether in liquid or gaseous form, gravity is always present, and as you will come to see, so is Deuterium, the code word for liquid Aniline. Where there is no gravity, you will also find no friction and no oxygen.

THE BIG SECRET ABOUT THE SUN

Throughout recorded time and ½ billion years previous, the sun has been the focus of deification from **Australia** to the **Hindu Cush** of **Zhunbil**. God arrives each day on a Matet (ship), at which time life springs anew once again. In ancient Egypt -who received their god from Sumer-Ur Babylon-, **Amen Ra** (Marduk Satain) and his wife **Nanna** (Inanna/Wawwu/Eve) gave birth to **Atum**, their *sun* the serpent god of the sea, who was the shining star that lighted the way for the Lulus (the seeds of Adam), the children of Ba’al. Together, the three make up the **Theban Triad** ∇, of which by now you are more educated on than nearly any human who has ever lived, at least for the last hundreds of thousands of years if not longer. Since the dawn (transliterated from **USH** meaning *the shining dawn*) of the Elohim’s arrival to earth, the **Trinity** has made up the **3** that has always been the **1** and the sun of man has always been **Adam**/Atum/atom, the miracle man of Tara-earth life who was able to impregnate humans personally on behalf of the **Elohim Three** who made their first Marduk in their own **avian** image. The **stork of Ra** delivers **baby** god each day across the waters of the **Holy Sea** and into the **heavens**; the judge over mankind. At night when **Atum** (autumn) **leaves** (the tree of life), he serves **adjudication** over the underworld, delivering Sin (Luna moon) whose **sine** waves illuminati(e) **Hel** (Luna Heliopolis) where HU (“*the sperm of Atum*”) mans repent to **Amen** the **father** of **god** for their imperfections

Decoding The Hive

creation of gravity, light, time and the god particle

before they lay down to sleep. Unless the **sun of god** ushers in the **morning star** (LUCifer, the *cipher* for the god of the LULus) to save mankind again tomorrow in a **second coming**, the unworthy, stupid **HU**-man hybrids (mudbloods) will die:



By now you are well aware that the **Krystal Seed Atom Aniline** in Deuterium is the secret ingredient within water that electrically powers life, and that no particle of liquid water is ever present without at least some content of Deuterium found inside. Deuterium is the heaviest of all forms of water, so it is at the bottom of the ocean (and below), and all *other forms* of Deuterium are in higher elevations. The less amneo fluid (Deuterium/water), the higher Aniline crystals travel UP to the cloud level and beyond. Air, or CO₂, is also water, just infused with much more **oxygen** which is delivered by **hydrogen** which is a secret code word for **Aniline**.

I will be explaining the sun's role in this process of transforming heavy water into thin water (air), but even earth scientists understand that the sun somehow **infuses** Deuterium with oxygen and hydrogen in what is called **evaporative sublimation** (evaporation of liquid to invisible liquid called gas), part of the life-cycle process of amneo fluid. The *surface water* the sun produces by evaporating ocean water is referred to as *distilled* and is much different from ocean or sea water, as the Aniline content called **sodium-chloride** (salt) has been largely removed, resulting in pure topographical water that powers the surface-earth life forces. The process of removing most of the sodium from evaporated water is all part of the process that Deuterium goes through while serving as the ONE life-force of all contributing elements. Liquid Deuterium

Decoding The Hive

creation of gravity, light, time and the god particle

can be thought of as “120 volts” in energy. Sublimation turns that into “12 volts” so the delicate surface life won’t immediately burn out like your cell phone being plugged directly into the wall socket without a transformer in between that reduces that electricity down to a much more subtle current.

LIQUID LIGHT

The sun’s frequency waves (not to be confused with light or heat, since the sun is not able to radiate either one of these elements alone, hence why space is **pitch black** and **ice cold**) cause the crystal-core of Deuterium to begin what has been labeled *positron decay* which is simply one form of energy being transformed into another form of energy, just as every single particle of energy is known to do once its previous mission is over. In this case, the Aniline molecule or *isotope* of Deuterium heavy water simply begins the transformation into oxygen/hydrogen-infused crystal bound together by the Liquid Silicate Matrix amneio fluid (which is the Keylontic Science delivery-system of energy that supports biological life called **Liquid Light**). Science even gives us hints regarding this truth in our everyday language by describing something that **weighs** less and what appears more **luminous** both by using the very same word, **light**. The lighter the crystal (less liquid water surrounding it), the lighter/brighter it is able to flash and the higher it will ascend. The heat produced at sea level when the sun strikes your skin is moderate. The heat it produces while you are standing on top of a tall mountain is *much* hotter, even though you might be surrounded by snow and ice. This is because the crystals are coded to increase their intensity on your skin to encourage you to remain within your life-zone below, and at the same time, flash much cooler while producing the illumination which is also to encourage you to return back to your designated playing field which is within a mile or two above or below sea level. They are also coded to release less oxygen at the mountain peaks for the same reason.

SWIMMING IN DEUTERIUM

The denser the Aniline crystal-content within the Liquid Silicate Matrix, the more friction. The more Deuterium, also going under the code word **brine**, the harder it is to move forward (swim or fly). Swimming in a river is easier than swimming in salt water in the ocean, even though your body is more buoyant there in the sea. Swimming through pure Deuterium isn’t even possible due to the density of the crystals (think *mud* or *gelatin*). The Dead Sea that is 10 times as dense in Aniline than the ocean is one of the most dangerous places in the world to try to swim, even though most of your body is suspended out of the water by the salt content (oxygen/hydrogen content), because it is so incredibly hard to move. The Dead Sea is so saturated with the intensely-high frequencies generated by this open source of the life crystal that its shores are **crowded** with **healing-water Spas** which are heavily-staffed with life-guards attempting to save the high numbers of people who find it nearly impossible to swim in. In fact, of all the bodies of water on earth, the Dead Sea is the deadliest of all outside of external dangers such as sharks or snakes and other elements such as nuclear waste or boiling temperatures, because it is so difficult to turn over onto your back if you find yourself face down for any reason. The water, while

Decoding The Hive

creation of gravity, light, time and the god particle

extremely buoyant, prevents one from pushing away without your arms pinning you to where they entered.

SUFFOCATING IN THIN AIR

The less Deuterium, the less friction (resistance). Jets wishing to fly using less fuel go to “thin air” above the clouds where the Deuterium is virtually depleted and has already begun making its way back down to surface-earth through the dew-point condensation Cloud Recycling. Deeper levels of space beyond the Troposphere have been shown to have effectively **zero** Deuterium content, so it has no crystal matter to cause impedance (slow down travel), which is simply understood as **friction**. Keep in mind that heavy water, regular water and hydrogen are all the very same thing, differing only in oxygen/hydrogen and Aniline content, which are virtually synonyms. The more oxygen/hydrogen content determines how high the crystals are allowed to travel and what mankind then calls that *version* of water. You can’t breathe Deuterium at the bottom of the ocean, and you can’t breathe where Deuterium is largely not present such as mountain peaks. More people die of **suffocation** from lack of air while hiking than they do from any other danger over 15,000 ft elevation.

Hikers can use **acetazolamide** to help combat the lack of oxygen in the air. So the obvious question is, what is acetazolamide? Naturally it is a pharmaceutical, which is going to have other ingredients added that are meant to poison you deliberately to keep the doctors who push the drug industry busy (one hand washes the other of course), but at the same time there will usually be something in the drug that does sort-of work to ease some of the suffering of the malady. The primary **active ingredient** in acetazolamide is **bicarbonate**, along with a few other things to make the pill stick together to the added poisons, etc. So what is bicarbonate exactly, and wouldn’t it be an **incredible coincidence** if we found **Aniline anion** (that creates oxygen) **ion crystals** at the base-quantum of acetazolamide?:

*Wiki: **Bicarbonate**;*

*“The bicarbonate ion is an **anion**. A bicarbonate salt forms when a positively charged ion attaches to the negatively charged **oxygen** atoms of the ion [same ion], forming an ionic compound.”*

Acetazolamide, code word for bicarbonate, is simply powdered oxygen - required when people reach elevations where the life force is not meant to be. Oxygen comes from water that is supplied to the proper atmospheres both through evaporation delivery as well as through trees and plants which detoxify the air and replace it with the oxygen that is brought up through them from the ground water. Oxygen simply does not exist where hydrogen isn’t present and liquid water doesn’t exist where oxygen isn’t present. If the oxygen were to suddenly vanish from the ocean, there would be nothing to keep the hydrogen (which shares the weight of water with oxygen at all times) from instantly escaping earth’s atmosphere, which means the only thing keeping the waters of the planet from turning into gas is oxygen. This is literally like saying that oxygen is water and hydrogen is the element that is antigravitic that allows water to be somewhere other than the bottom of the lowest land mass. Without the weight of water

Decoding The Hive

creation of gravity, light, time and the god particle

surrounding the hydrogen (Deuterium) molecules (which you know by now are actually tiny crystals), there would be no such thing as gravity. And no, the mass of earth has nothing to do with that. Oxygen is actually *water* in its gaseous form. Hydrogen is the vehicle that lifts both liquid water and gaseous water to allow the oxygen to permeate the life field with energy.

When **hydrogen** is added to **oxygen**, it *creates water*.

So where do I get off saying the pharmaceutical industry is harmful anyway?

usage: opposed to *Sadducees*.
2. [p-] a pharisaic person.
phar'i-see-izm, *n.* same as *pharisaism*.
phär-mä-ceū'tiç-äl, **phär-mä-ceū'tiç**, *a.* [Gr. *pharmakeutikos*, from *pharmakeuein*, to practice witchcraft, or use medicine; *pharmakon*, poison or medicine.]
1. of pharmacy or pharmacists.
2. of or by drugs; as, *pharmaceutical cure*.
phär-mä-ceū'tiç-äl-ly, *adv.* in the manner of pharmacy.

ION ANILINE GRAVITON

Oxygen molecules and hydrogen molecules are strictly associated with each other. When oxygen is present, so is hydrogen, which is another hint for you that these are the same elements with a positive side + and a negative side -. When hydrologists measure the nature and decay factors of oxygen, hydrogen is simply included by default in those numbers. Remember that the word **ion**, just like the words **Deuterium** and **Hydrogen** is a *code word* for **Aniline**. Ions are the **carriers** of all known usable energy, and also the **carriers** of oxygen. Also keep in mind that when science refers to ions, they specifically refer to *where ions are found* is in **crystals** and further go on to make the distinction that oxygen is carried **inside** those crystals. Also, notice that ion “anions” are known of **as** oxygen which literally means **up** from ancient **Greek** *ano*. The ion **cation** (+) which carries the positive charge is tiny in comparison to the energy of the **anion** (-) side of an ion and literally means **down**. By now you likely are beginning to realize that the **Krystal Seed Atom Aniline Ion** is both the **oxidizer** (breath of life) **and** the **graviton**:

Wiki: Ion anions and cations;

An **anion** (-) (/ˈæn.aɪ.ən/ AN-eye-ən), from the Greek word *ἄνω* (*ánō*), meaning “**up**”, is an ion with more electrons [-] than protons [+], giving it a **net negative charge** (since electrons are negatively charged and protons are positively charged).

Decoding The Hive

creation of gravity, light, time and the god particle

A **cation** (+) (*'kæt.ai.ən/ KAT-eye-ən*), from the Greek word *κάτω (kátō)*, meaning "**down**" [code word for 3rd dimensional or "material"], is an ion with fewer electrons than protons, giving it a **positive charge**.

Cations and anions are measured by their ionic radius and they differ in relative size: "Cations are small, most of them less than 10–10 m (10–8 cm) in radius. But most anions are large, as is the most common Earth anion, oxygen. From this fact it is apparent that most of the space of a crystal is occupied by the anion and that the cations fit into the spaces between them."

Oxygen (outside of fluorine alone) is **the most electronegative non-nobel gas element** (empty gas tank in science's desrever terms), whereas hydrogen has a slightly **positive** charge. This means that water once infused with hydrogen/oxygen becomes "polarized" or "active":

- The **thinner** water gets, the **more** hydrogen/oxygen (HO) is present
- By the time water becomes heavily-laden with HO, *water* is no longer called water, it is now called **air**. This just so happens to be where the *most light* and the *most heat* are coincidentally located (around sea level and above)
- The higher **up** you travel, the **thinner** the air becomes, and the less hydrogen/oxygen happen to be present around mountain tops
- **Coincidentally**, the **colder** (*less heat*) the elevation gets, the **less** HO and the **less** Deuterium

The sun's waves are the most effective frequencies known to mankind to activate ions, releasing oxygen and hydrogen from Deuterium. As mentioned, all that has to happen to create these two elements is to set Deuterium out under the sun. The Morse-codes carried in the song of the sun is the key of unlocking CO2. The hydrogen lifts the Aniline crystal into the air and the oxygen (the actual energy) then spreads all across the playing field. Without hydrogen that always accompanies oxygen, the oxygen would have no way of getting to the life force at all. When the sun has released nearly all the oxygen content of the crystal, it is captured in the recycle zone of the clouds and then it pushes downward back to earth's surface where it strikes equilibrium at **sea level**, which is why you **weigh more** there than you do hiking where you need acetazolamide in order to breathe *and* a coat to stay warm.

Of course we have known all along that it is colder in the mountains than it is down in the valleys, but who has ever actually explained what causes this difference which can be extremely dramatic? You are about to find out *why* there is snow at the top of the mountain and why it never snows at sea level. And since this has to do with the "glass shell" surrounding earth, I am guessing you will be interested in that answer.

Not only do **Ion/Aniline/Deuterium/Hydrogen/Oxygen Seed Krystals** support life and create reality for living biological life, but it forms what is called the Planetary Hydrosuspension Dome, or what Council refers to as the **Atmospheric Membrane**. The "brane" is created by spent-oxygen Aniline crystals that collate at the exact apex of the Event Horizon of the geometric

Decoding The Hive

creation of gravity, light, time and the god particle

pattern command that is positioned in the zero-point of earth, which naturally creates a sphere. This report won't get too deeply into this topic, except to say that the **ultra-clear, ultra-dry** Aniline crystals collect together at their apex point much like the ice crystals of a slushi which provides a **liquid shield** around the planet, keeping most space debris from getting in, and preventing mankind from getting out until they have reached the point where their technological understanding of astrophysics evolve beyond the rudimentary levels of today.

CHAPTER 30

PLANETARY ENERGY



Heat does not come from the sun, it comes from energy. The sun releases neutrinos that impart energy into crystal that carries that energy and release it when needed. The process of imparting the energy is what creates heat through SET as already mentioned. While the grids are recharged by Deuterium, they are also continually being recharged by direct neutrino strikes as well. In Nibiru Diodic Crystal Temples made of crystal beams as large as houses or skyscrapers, the air around them is suffocatingly hot. Geological teams looking to study these off-planet anomalies

Decoding The Hive

creation of gravity, light, time and the god particle

must wear specially cooled suits in order to survive the 136 degrees. Such temperatures within the mantle are not found other than surrounding such Temples, or where magma is located which was generated by the same type of ionic friction. In normal soil with low oxygen content, it would be freezing cold. These were transported to this planet from Sirius-B and are not native to earth:



THE CREATION OF GRAVITY, HEAT, LIGHT, LIFE AND TIME

As briefly touched on in the last chapter, the weight of a person, cow or duck is 100% at sea level. If he jumps into the water, he weighs much less due to the oxygen (lighter water cells) in his body. If he adds weights around him to push him down deeper, with each meter he travels down, the greater and greater gravitational pressure surrounds him. If he reaches the ocean floor, the pressure from heavy water increases up to **1000 times** that of surface water or surface air. We don't call this gravity at that point, even though science claims that the closer you travel toward the center of the earth sphere, the greater the gravitational force, and the further away you are from that center, the less gravity as explained by modern academia:

“The farther away the centers of mass of the two differing-sized objects get, the smaller the force between them. According to Wolfram Alpha calculations, the difference in gravity per the equation above means that the gravity at the top of Mount Everest is

Decoding The Hive

creation of gravity, light, time and the god particle

99.72% as strong as the gravity at sea level. Thus, if something weighed 1000 lbs at sea level, it would weigh only 997.2 pounds at the top of Mount Everest."

This is the constant "gravitational pull" equation of modern science, attempting to explain why things are lighter at the top of a mountain than at sea level (surprise, you weigh less depending on where you stand). And because they have water buoyancy to contend with at the bottom of the ocean, they only have to account for such "pull" at sea level and above, so they never have to account for the fact that buoyancy only *increases* the closer you get to earth's center (repelling oxygenated objects) and never the other way around. If gravitational pull actually existed, a vessel (submarine or human) would be drawn stronger and stronger downward once the oxygen of the vessel reached equilibrium with the water's weight or mass. *This never happens, and in fact exactly the opposite occurs because "gravity" is carried in the liquid capsule of the water which is the **energy** inside of the crystals inside the liquid.*

Water "breaks all the rules" as it were regarding its transformation into gas, its transformation into solid and at which temperatures all these things happen. It is extremely delicate while at the same time it is incredibly powerful and can carve a rock in half given enough time yet viscous enough to find a leak in your water container far too small to even see. Nothing else is even remotely like water, even those things that are usually liquid like water and can transform into solids or gasses. Amneo fluid in liquid form (or gas) clings to the crystal so wherever water is present, so are Aniline crystals referred to as **DU** or **D** content.

Water containing Deuterium crystal content has a known field of migration. Where water is liquid, such as in ocean water and especially at the bottom, DU is present in greater numbers (you will soon find out why). At higher elevations, DU *decreases*, just as water in liquid form decreases and becomes either gas (invisible air), or snow (frozen water).

Liquid and gas water always has DU content, just as oxygen always has hydrogen content. But hydrogen/oxygen *is not always present* in liquid and gas water. I mention this because Deuterium's mission takes an unusual path when it is introduced back into the battery phase at the bottom of the ocean where it is missing virtually all active hydrogen/oxygen (HO). When water goes through its "surface-life phase" however, it becomes saturated with hydrogen and oxygen. It is in this difference where life and gravity come prominently into play for our life zone. For now, think of the ions which are *pure energy particles* infused in the crystals of heavy water as *heavy*. It is hard to think of an invisible particle as having weight, but it does. At least within the script in use within this Time Matrix. Remember, how things work within the playing field are scripted in, not following rules that necessarily make sense to us based on how other things function. Amneo needs to carry qualities that are unique only to amneo in order to define one substance that is never actually "lost" through its transitions between one mission to the next.

The ions inside the Deuterium crystals power *all functions of life* within this playing field. As you have already had illustrated, the ions coming in from celestial forces powers oil, which powers Deuterium, which powers water, and then water (wireless energy) powers all surface life. Once that energy has been transferred from ocean-floor and below to higher dimensions (surface and above), it also gives out light and heat. Without the invisible rays of the sun acting like a

Decoding The Hive

creation of gravity, light, time and the god particle

match to strike the “flame” of this energy, neither heat nor light exist (in surface-levels and above). This is why science claims there is no heat signature in “space”, because there is no water content of any kind in space. While the friction created by Deuterium energy crystals dragging across earth soil and rocks does create heat within the mantle, that heat is not transferred to the surface outside of anomalies such as volcanic eruptions or sub-mantle eruptions that allow small amounts of heated water to reach surface levels.

NEUTRINOS + ANILINE = GRAVITY

The sun’s invisible frequencies must be present to illuminate and heat earth’s surface. And while it appears the light and heat is coming *from* the sun, it is not. It is coming from the crystals that are carried up from the ocean when the top layer evaporates by the neutrinos striking the water and releasing oxygen and hydrogen that lift the crystal into the air (now transparent water) so they can produce maximum light and heat with zero diffusion between them and the neutrinos. The transition from liquid water to transparent water is called evaporation, but in truth, it is technically ionization which is a transfer of energy from the neutrino to the crystal. Neutrinos basically *charge and turn on the flashlight* of those crystals. Above the ocean surface is warm, in the water its colder, 10 feet down it is much colder yet. And it is all due to diffusion or blocking the neutrino more and more the deeper the water gets.

The **greater diffusion** between the ionized crystal (now suspended over the surface of ocean level) and the neutrinos (sun waves), the less light and heat will register on the other side of whatever is blocking out the neutrino, be it sea water, a tin cover, or a rock. We already know that standing in direct sun is very hot. Inside a tin building in direct sunlight, the temperature is also hot. But a stone building (or cave) in the same spot will be cool or even cold inside. This is not because the stone is personally refrigerated somehow, but because the **density** of the stone resists more neutrinos than a thin sheet of tin.

Since neutrinos pass through solid objects **less** when the material is higher in density, areas under that shield will not carry the same heat signature as areas under other, less dense materials. This gives the illusion that the sun’s rays themselves are hot, because materials that typically respond to the neutrino recharge get hot themselves while passing along the energy. The tin building allows far more neutrinos to “pass through” because of the oxygen content inside the tin that the stone doesn’t have. The oxygen content inside the material acts much like an open door for them to pass through. But notice that not all the same heat will be below a tin cover as on top of that cover, and there will now be a shadow underneath which tells you that some of the neutrinos are working to project the image of the tin roof upward (as you can see from a plane), so there are less energy cells below that cover to act to cast out light and heat. But some do make it through, that is why you are still feeling heat there. And we credit the difference between the temperatures inside the tin building being warmer than inside the stone building because the sun’s “light” isn’t penetrating the stone. But the sun’s light isn’t coming through the tin either, and still there is this huge difference anyway. (?)

When the oxygen (open door) content **and** the ion (energy) content are both blocked from the neutrinos, it is always cold and it is always dark (like in a cave). Stones do not hold the same

Decoding The Hive

creation of gravity, light, time and the god particle

oxygen content that tin or other metals do, so therefore stones remain cold unless subjected to prolonged exposure to the neutrinos, and even then, only the top surface of the stone will usually become warm. Tin left in the sun will get extremely hot, sometimes enough to fry an egg. If it is the same “heat” hitting the tin as hitting the rock that is cool enough to sit on, then there must be another answer, because I can promise you this, if I warm up a piece of tin and rock side-by-side with the same flame-thrower, you will be able to fry eggs on both of them. So it isn't something **else** that is creating the heat signature, but it is the things that are below the sun that are generating that heat themselves which are activated by the frequencies cast over them.

In the **Cascade Mountains of Oregon and California**, lava beds cover 130 square miles from the area surrounding the Medicine Lake Volcano that has been active for 500,000 years, creating a blistering-hot desert, void of vegetation and most trees for miles in every direction:



The desert can reach temperatures up to 120 degrees, yet **10 feet** below the surface, there are caves that are perpetually frozen with ice from ceiling to floor that **never melts**. Obviously there is no freezer going below, and obviously it is boiling hot just a few feet above, so something is going on that has not yet been explained. How?:

Decoding The Hive

creation of gravity, light, time and the god particle



The volcano has opened a path from the super-capacitor oil at the core of earth to the surface, depositing large amounts of volcanic carbon in heavy layers that block the neutrinos from getting below the surface in large enough quantity to activate the crystal Aniline that is used as the upper strata surface energy source. If the neutrinos are unable to recharge the ion capacitors that power the playing field, then there simply will not be heat. Because of the intense density (as it has now turned into a glass shell, therefore the door is closed to oxygen) of the carbon lava that absorbs the neutrinos in a frequency not used at surface-levels, there is no heat being released within the mantle below, so the water in the soil simply freezes. This has nothing to do with being closer to the cold of space, as it is just 150 feet elevation, and as mentioned, the surface can be as hot as 120 degrees in the summer. The density of the lava acts like a lead-shield blocking the energy that is attempting to reach the crystals that actually dispense heat. Anywhere else in California or Oregon at this elevation, it would be impossible to dig down below a 120 degree surface and find frozen water. Ever. Not even if you went down ten miles, much less 10 feet.

Lava is made out of oil that has become liquid-hot, which burns off everything that can burn, even under temperatures over 2000 degrees, leaving what is considered unburnable insulation. This is known as carbon and used in applications of insulating the extreme temperatures of the space shuttle nosecone from white-hot reentry friction melting the hull. Since it is devoid of oxygen and devoid completely of Deuterium, the neutrinos simply deflect from that substance. The only way to make a material that is utterly devoid of Deuterium is to elevate its temperature to a level that incinerates the amneo fluid and melts the crystal capacitors, nullifying their ability to absorb energy. Lava (carbon) is effectively “dead matter” for want of a better term. No other material can substitute carbon when it comes to resisting neutrinos, thus it makes the most effective insulation from heat. But it does not insulate from cold, as carbon is a natural cold

Decoding The Hive

creation of gravity, light, time and the god particle

conductor. This would be an impossibility if that material were an insulator, rather than a **deflector**.

In this Harmonic Density, the carbon crystals of the oil bond or fuse with the silica crystals below the mantle during the SET process while transferring energy from the oil super-capacitors into the crystals of the liquid amneio fluid, creating a carbon-silica crystal which is both very refractive (silica) and the oxygen-closed-off crystal of carbon. While they are lighter than water once the silica portion is carrying oxygen and hydrogen, they are both denser than surface water before this, so they will naturally sink once that oxygen and hydrogen is gone (which prepares them for their next cycle, explained later). The very curious thing about this is, the lift of the dark-blue Deuterium comes about in two different ways. First, it becomes oxygenated by diluting the liquid that is carrying the crystal upward with already activated water which provides more and more lift, so it can make the long journey all the way to the surface. Basically it is simply “hitching a ride” using oxygen/hydrogen from other already *activated* particles sloshed down from the surface.

While now slightly lighter from this dilution and therefore a little higher in elevation than the pure Deuterium at the bottom, it is still very dense. As it slowly rises, the **carbon** is physically **blocking** the waters from being penetrated by the **neutrinos** that are attempting to strike it directly enough to begin its own transformation. This keeps all lower levels of the ocean extremely cold, and virtually void of oxygen. Only when enough hydrogen and oxygen has been released from its own crystals will that allow that droplet to begin transforming into transparent form. At this point there is now illumination in the water; the gravitational resistance has been lowered, which allows scuba divers to reach those deeper illuminated levels. Then once it is in the **direct path** of the neutrinos, it will now begin to release its **own** oxygen/hydrogen activation, but not until the path is unobstructed, which means within just the very top levels of the ocean. Only then does it actually take full flight and begin delivering its energy to the surface level.

While deep-sea submarines are able to reach the ocean floor in some places, they simply **bounce off** of the Deuterium beds as if hitting **land**. The same resistance is met by any body with oxygen levels reaching lower oceanic atmospheres, and that resistance only increases the further you attempt to go down. This is due to the **push upward** of the carbon-silica seeking sea level from the ocean floor. The bulk of the carbon that is continually pushing **upward while** resisting bodies carrying oxygen from going **downward** is constantly being forced to **remain below** by the massive levels of oxygenated water from the surface water that is being activated by the neutrinos from the sun. Only when water (liquid, gas or in its most condensed form in Deuterium) is still present is there such a thing as gravity. The heavier the water, the greater the gravitational push toward the equilibrium of the ocean's surface.

If the sun's waves were actually hot, then relatively translucent bodies of water wouldn't block that heat, it would multiply it just like a magnifying glass. But of course this doesn't happen, because the lower you travel downward in the ocean, the more carbon is blocking out neutrinos, so the colder it gets, not warmer. And then once the carbon-crystal has shed all its oxygen along with its hydrogen, it is now suddenly heavier than the air around it, so it begins pushing back downward again, and back to that same sea level it was struggling to reach once it began at the ocean-floor. So carbon acts like a buoy while in the water, and then it acts oppositely once it has

Decoding The Hive

creation of gravity, light, time and the god particle

delivered its fuel to the cloud level. In reality, it was never lighter than air, the hydrogen only canceled out its gravitational signature while floating above sea level and the surface-level oxygen cancelled out its gravitational **resistance** while below.

The lower down in the ocean, the **less** oxygen and **less** heat and the **more resistance** against anything trying to move down **below sea level**. The higher up in the mountains, the **less** oxygen and **less** heat and **less resistance** to go back down **to** sea level. The entire system literally works to keep humans **at the surface level** of the ocean, because this is where light, heat, life and time are synchronized to work at their most optimal level, at **equilibrium**.

THREE ELEMENTS MUST BE PRESENT TO CREATE ILLUMINATION

- Oxygen (oxidizer or what makes things “burn”) must be present
- Aniline energy crystals must be present
- Sun’s precisely-tuned frequencies (which act like a “match) must also be present

Without all three of these elements, there is no such thing as heat, light or surface life. Gravity always exists within the playing field in all its lowest level without the rays of the sun triggering light and heat, but gravity alone does not create higher atmospheric life; it is merely one component needed to support it. The **graviton** at the core of Aniline has a multi-faceted mission and at all times the production of gravity is present, even when it is not producing light or heat. The torus field around Aniline crystals carries the signature of both gravitational push downward from the Membrane, and gravitational push upward from the core of earth to sea level to keep human life (among others) at equilibrium. Most marine life from lower ocean levels requires much less oxygen to propagate as do life forms above that level. The heartbeat (pulsation from incoming neutrino waves) bring gravity (Deuterium) up from below the ocean to higher levels where oxygen carried by the sun’s frequencies from the surface then mix together to circulate oxygen at differing levels depending on the lower life zones. Oxygen itself does not rise above sea level on its own, that’s why hydrogen accompanies oxygen wherever oxygen is found. And wherever water is found. Remember, to physically “make” water, all you need to do is add hydrogen and oxygen (back) together. One is the higher-life-imparting activator (oxygen) and the other (hydrogen) is the vehicle by which both the activator along with Deuterium energy (and gravity) is able to circulate the planet on a surface level. **Oxygen** isn’t lifted any higher than the Troposphere, but the **hydrogen** continues upward (for some crystals) long after the oxygen energy has been depleted, this is why hydrogen is found in “space” (the upper atmosphere), because it is still on-mission to deliver a small handful of Aniline to the Krystalline Membrane. Only **below the Troposphere** does the Aniline crystal still carry its liquid amneo content, so therefore there is no gravity in space.

Only when water is still present is there such a thing as gravity. The heavier the water, the greater the gravity.

Decoding The Hive

creation of gravity, light, time and the god particle

ENERGY INVERSION

If you have ever used electric transformers (or batteries) to power a battery-operated gadget, you know that depending on how small or delicate the gadget, the lower the voltage is that its transformer or battery puts out. You cannot use a transformer from a heavy-duty cordless power drill to recharge a cell phone or a Bluetooth earbud. That's because the circuitry inside the earbud is made up of very fine, thin wires. Whereas the power drill has big heavy cables running through it to carry many times more energy. 12 volts of Direct Current power would fry a cell phone or earbud on contact just like it would traveling through a fuse that is set up for 1 volt. Likewise heavy water which can be likened to let's say "120 volts" of direct current would fry the circuits inside a flower or dandelion, but all 120 volts are required to recharge the energy within city-sized Krystal Cathedrals which must broadcast a signal to the entire atmosphere of the planet. That is why the first thing that Deuterium does when it is at full-charge is restore the planetary power grid. Once it has transferred huge volumes of its ions to the Grid, then it moves on to begin powering other things with ever-reducing voltage requirements.

When water is *heavy liquid*, its energy is very high. In a random study done on **Deuterium** it was reported:

*"In separate experiments heat **output** was **five times exceeding** the **input** electric power was observed. The result for the charged particle spectrum measurement revealed that charged particles with energies up to 18 MeV and an average energy of 2-4 MeV were seen. Gamma-rays with energies of about 200 keV and a characteristic X-ray radiation were registered".*

Again, the energy that is inside a power-cord (copper wire) is already there, as the copper is *saturated with* electric ions (like a gas tank that is already full). When you flip the light switch the bulb instantly lights up, not because the energy is coming from the dam 20 miles away faster than the speed of light, but because the energy is already there and awaiting the flow to begin again. The water of Deuterium is already full of energy as well, so when the scientist sent in a flow of electricity, even more energy came out of the water because the water was more saturated with electric ions than the copper wire he was using for his test and the energy sent in was physically manufacturing energy (imparting oxygen) at the same time.

This is free-standing electric energy and literally means that if you filled a tube with Deuterium, hooked up a power-cord to one end, attached a cord to the other end of the tube, more electricity would come out than what you used to start with. And the ocean is absolutely filled with electricity, just sitting there waiting to be tapped, or more accurately, **activated** to produce even more energy.

When water is *regular liquid* (tap water), its energy is very low. When water turns into gas (on its way to becoming distilled or "rain"), the Deuterium energy has largely been left behind right there in the ocean in the form of crystal which we call salt or sodium chloride. This is the type of water that is able to transition into ice at 32 degrees (void of most salt or **Deuterium**). Wherever water is no longer liquid (such as air), its **DU** (Deuterium ENERGY ions) is lower even yet. The

Decoding The Hive

creation of gravity, light, time and the god particle

battery power of tap water has been lowered in order to power other things within the playing field that use more delicate energy levels, and the power of water once turned into vapor is even lower yet so it doesn't over-power your lungs. All that would be needed to breathe water is to remove most of the oxygen/electricity (Aniline crystals) from it first, as it is already totally saturated with oxygen by the mere fact it has already been distilled. You aren't "drowning" in water, you are getting too much oxygen which overpowers the delicate tissues of the lungs. A land-animal (such as a human) can drown in a teaspoon of tap water, not because the lungs **fill up** with water preventing it from access to air, but because the electricity-quotient is literally too high for the tissues of the respiratory system that need let's say "1 volt" instead of "120 volts".

First the energy signature of pure Deuterium must be lowered, then it must be taken into the upper atmosphere in order to equally distribute that more delicate energy to *the flowers* let's say. Deuterium is **carried** by hydrogen and its **energy** is **activated** by oxygen when also accompanied by the frequencies of the sun. If it seems like I am explaining this 20 different ways, it's because I am because it is simply so foreign to our mindsets to grasp. If this disclosure does one thing, it should be reeducating the population about how things actually work.

Hydrologists understand that when it comes to our everyday life, there are two different types of water (basically speaking) as I have already mentioned; *seawater* and *meteoric water* (freshwater). They already know that all water ultimately "comes from the ocean", but it becomes a distinctly different thing once it has undergone evaporation and sublimates into vapor (turning into clouds), and then back into liquid when it rains back down again. *Meteoric water* has undergone sublimation, whereas seawater hasn't. And seawater's job is extremely different than meteoric water. Seawater with super-concentrations of ion energy powers ocean life. Marine whales that are larger than **houses**, and **electric** fish need high energy to power their bodies and abilities which are far different than life forms that live in freshwater. Some ocean-forms generate their own flashlights in order to attract prey to survive, such as the **anglerfish**. That energy doesn't just come from nowhere; it comes from ion-infused Deuterium. Angler fish cannot live in rivers, lakes or ponds:

Decoding The Hive

creation of gravity, light, time and the god particle

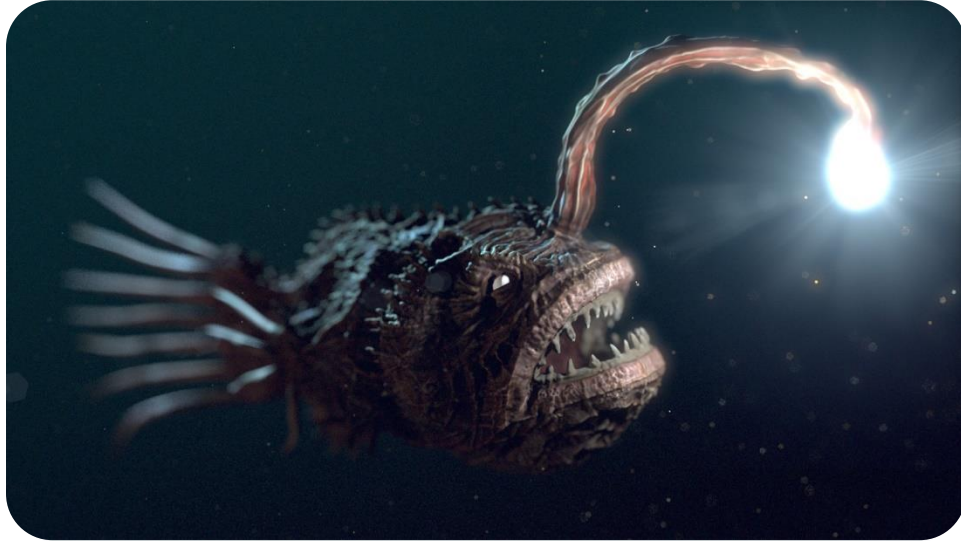

EGYPTIAN ELECTRICITY

The difference between regular water and salt water is the same difference between a bucket of water with two metal rods inside doing nothing, and a bucket of water with salt added that now becomes a battery. The sodium-ions carried in the salt turn that bucket of water into an electrically-charged power source, just as shown in the **Baghdad Battery** that was filled with saltwater, proving that electricity was hardly invented by someone in modern times:



Decoding The Hive

creation of gravity, light, time and the god particle

Touched on briefly prior, the Baghdad Battery is an urn located from **Māhōzē, Baghdad**. This is the heart of the **Fertile Crescent** known in Sumerian times as **Babylon** which predates Egypt by many thousands of years. Science likes to date this to 223 B.C. to the Parthian Empire period, rather than admitting that Sumer-Ur had electricity as far back as 9000 B.C. The **Dendera lightbulbs** hieroglyph found in the temple of **Hathor-Mary** (Wawwu/Eve) in Egypt shows the technology existed during their time of 1500 B.C., so it is obvious that Egypt had electricity and since Egypt was ruled over by Sumerians throughout their reign, it is little more than a skip to assume it was simply brought to Egypt when Sumerians expanded west to Egypt, seeing as they already had space crafts, paved roads, helicopters, hovercrafts, submarines and indoor-plumbing eons prior to migrating:



The urns (many have been found now in the same area) were fitted with copper and iron rods which both “decay” while in water with salt added, producing electricity. These have been duplicated many times by scientists showing that they worked beautifully. The technology is now called an **earth battery**, because a simple copper rod and iron rod 10 feet from each other hammered into dirt in an area high in salt produces continuous free energy:

Decoding The Hive

creation of gravity, light, time and the god particle

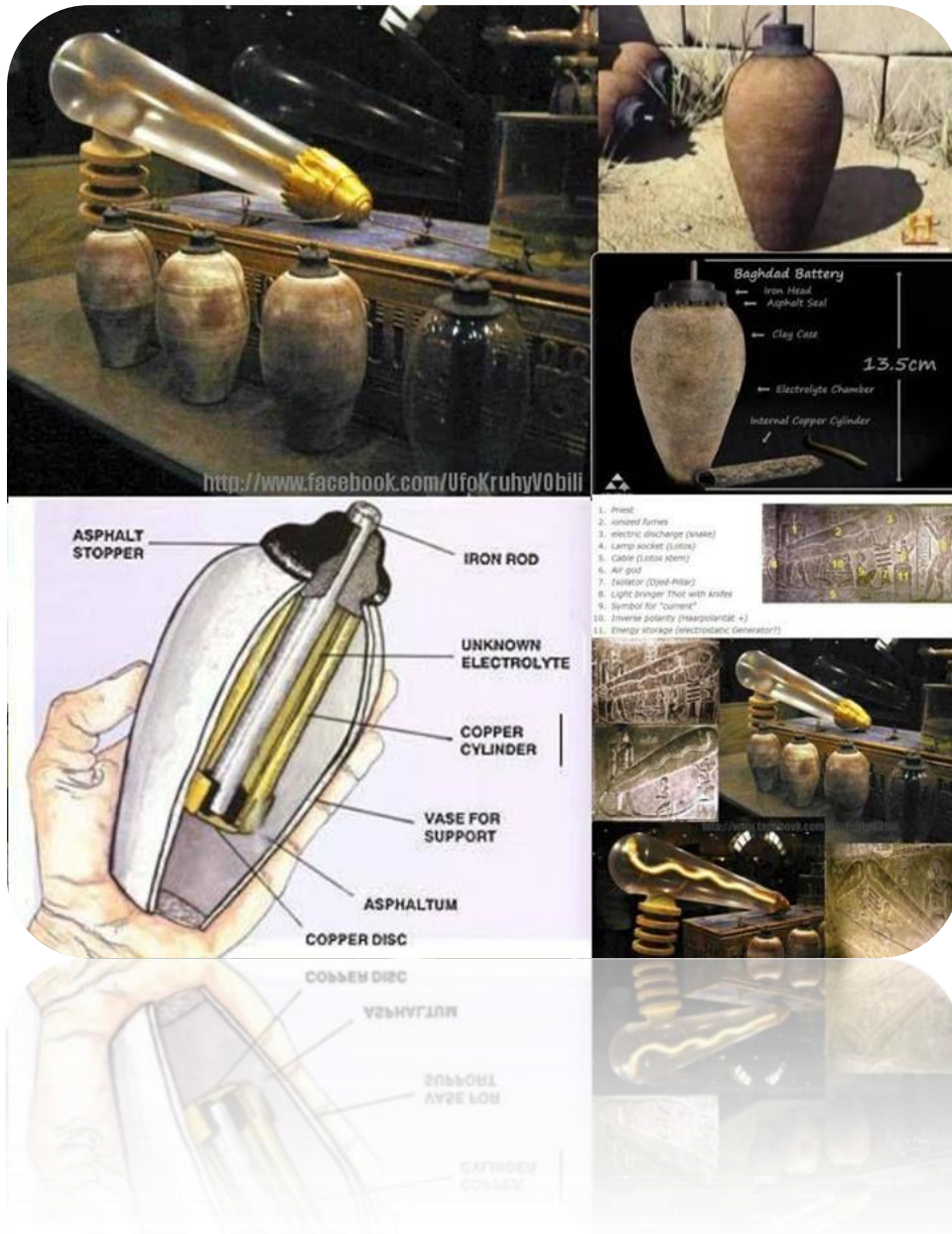

And to get the salt into the battery, all they would have had to do is fill it with sea water or even urinate into it, because the human body carries 40 teaspoons of **salt**, or **sodium-chloride** at all times. This is why urine, semen, sweat and tears are salty. As mentioned, the Aniline salt crystals in your bloodstream are the electric batteries powering your body. When regular meteoric water (tap water) has had sodium-chloride added, it is now called **electro-lyte**, as in “full of light” which is a synonym for energy. Seawater is entirely an “*electrolyte medium*” as used innumerable times by scientists developing new processes such as **Louis-Jacques-Mandé Daguerre** who was able to remove the excess silver iodide from his developing solution for freezing images projected onto a copper sheet taken in a pinhole camera (which had already been invented and used **thousands of years ago**, reported by Aristotle in **350 B.C.**). The silver iodide worked like a barrier preventing the image from escaping and the ocean water removed all but the most transparent top-layer of the silver from the sheet. Using saltwater as the correct level of

Decoding The Hive

creation of gravity, light, time and the god particle

voltage-to-amps energy to break down the silver, Daguerre announced: "*I have seized the light – I have arrested its flight!*"

Energy is broken down into two groups, volts and amps. Think of *volts* as *BBs* and *amps* as *cannonballs*. Both are round balls of steel, but if I toss a BB at you playing catch, you will barely feel it in your hand. If I toss a cannonball at you, even very slowly, it can knock your entire body to the ground. The energy for surface-earth is like BBs; delicate, subtle energy. The energy for creatures making their own light and using it to **kill** predators the size of a human are cannonballs. Once you see how ion-infused Deuterium works, you will see the system in place is far more than just clever, it is truly amazing how plants and creatures get exactly the right voltage to power their life-existence, from the inky-blackness of the ocean floor to the daisy sunning itself at the peaks of the Swiss Alps. And even though water looks like water wherever you go, it is a constantly-changing thing depending *where* it is needed.

The ocean is a massive battery in real-world terms.

There is no comparison between the electricity that flows in the ocean compared to the electricity in freshwater. Everyone has heard about electric eels that live in freshwater in the Amazon. **Freshwater** electric eels produce up to 860 volts carried with up to **1 ampere** of current, whereas **ocean** electric rays produce electricity of 50 to 200 volts and **30 amperes** (amps). While 860 volts compared to 200 volts might sound like a huge difference, in reality you can look at it like the freshwater eel delivers **860 BBs**, while the ocean electric stingray is throwing **200 cannonballs**. One will stun you but the other will turn you into yogurt. Steve Irwin (crocodile hunter) learned of this power first-hand when he jumped on a stingray's back during filming of **Ocean's Deadliest** and was fatally electrocuted, as the ray's tail delivered the amperes directly to his heart.

NUCLEAR KRYPTONITE

Who knew that electricity would be the kryptonite that would kill the widely-regarded "superman" Steve Irwin? And is it any surprise now that comic-hero Superman's only weakness was "kryptonite"? Do you know there is such a thing as actual kryptonite? Incredibly, there is, it is called **Krypton Difluoride** which is a complex **salt** according to science. And more incredibly even yet is the fact that it is made out of **uranium crystal**, the very same thing that powers thermonuclear warheads *once it has been bombarded with Deuterium heavy water* (seawater). Even more incredibly, is the fact that somehow this crystal that was the only Achilles' Heal of Superman, just so happens to be spelled like the real spelling of the Angelic Human **KRY**stos; **KRY**ptonite. If you think that this material was simply the imagination of a comic-strip writer then you are not following along:

Decoding The Hive

creation of gravity, light, time and the god particle



WIRELESS LIQUID ENERGY

Crystals can be thought of as sections of power cord or *optical fiber* that has an insulating shell that allows ions to enter one end of that “cord” carried in the amne fluid water to pass through it to another section and then to another section as the crystals align themselves due to the presence of that energy now in its field that is powering this self-arrangement. These crystals are *paramagnetic* meaning that both ends of the crystal (the hard shell of the cord let’s say) are magnetic in both ways, just like a bar magnet, each attracting to positive or magnetic energy. So when they come close to each other, either end of that magnet will attract to another section of crystal closest to it, connecting the flow of energy. This means that water carrying Aniline crystals, such as Deuterium in its most saturated form, is a living or *fluid* conductor of energy.

When “calcium” (Aniline crystals) are left at the bottom of your pot after burning off the water above, you will see they all align, pointing effectively one direction, even though there are

Decoding The Hive

creation of gravity, light, time and the god particle

multiple “fingers” of each crystal at the positive ends that can complete each connection. They will always point in the direction where that energy is being tapped from. If the water hadn’t been boiled out of the pot, then the crystals wouldn’t be all pointing in one direction where they dried, because there would have been no demand for their ions and they would simply be in a resting state (and just dancing around making girly-shapes in the water), just like as shown in the Bubble Chamber at CERN while they are awaiting the strike of a neutrino:

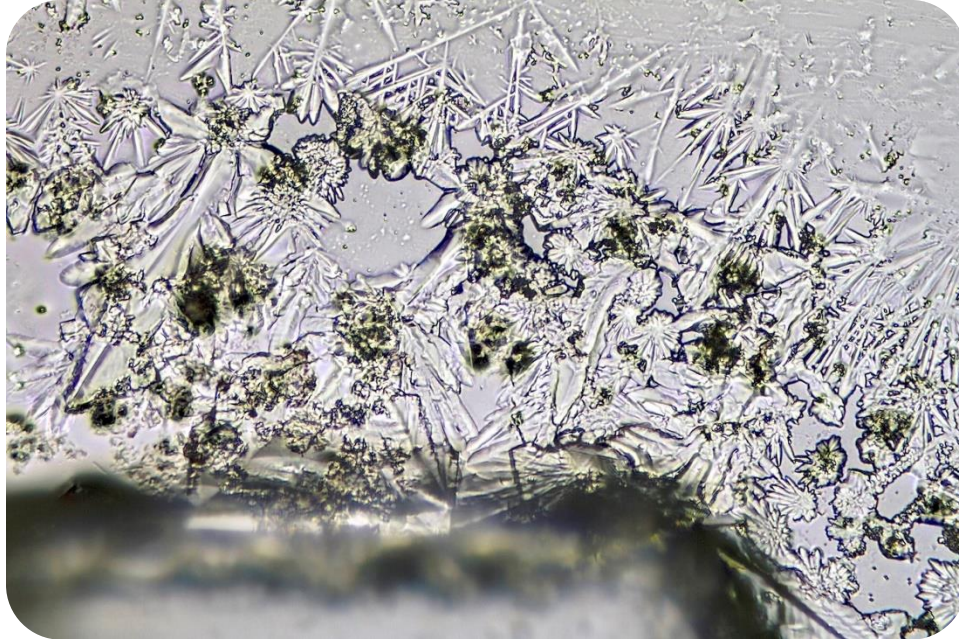

You will notice in the image below, one end of a crystal is ground and the other end is actually multiple points sticking out like fingers that quickly find the ground end of another crystal to complete the connection. To emulate this, a cluster of optical fiber would have one connected ground to all the strands and then the outgoing opposite end would be able to connect the flow through any one of the fibers;

Decoding The Hive

creation of gravity, light, time and the god particle

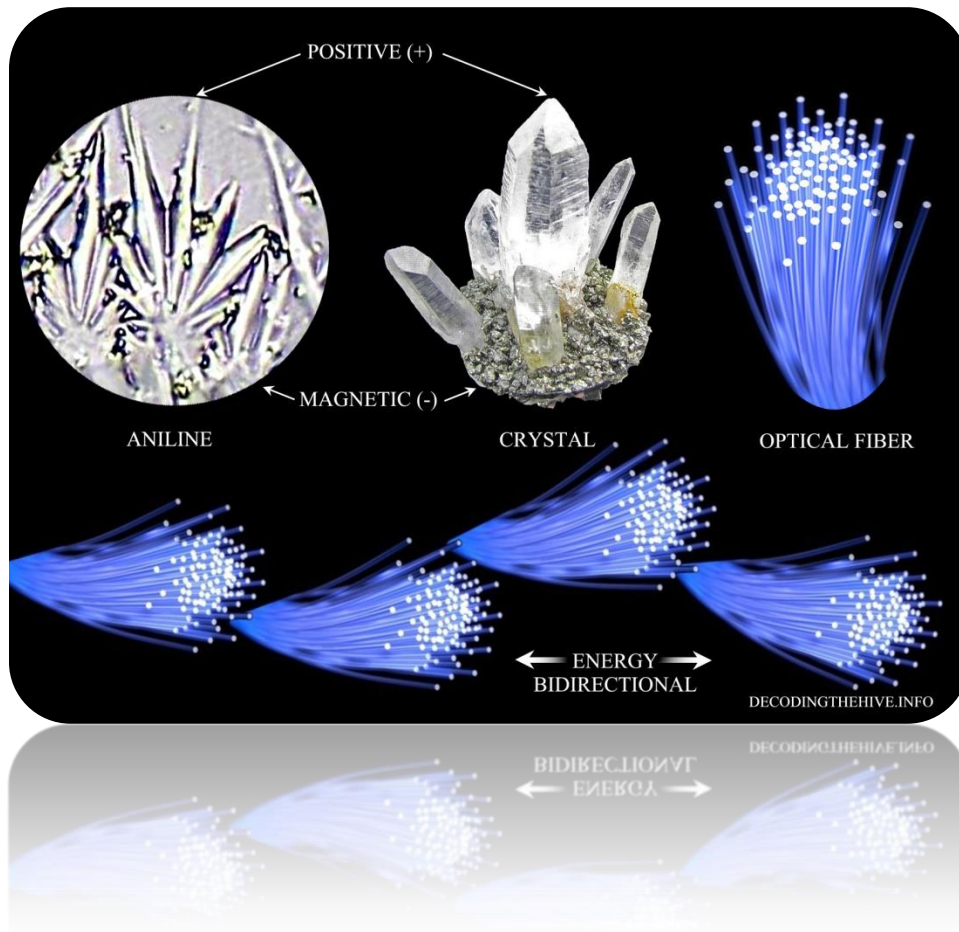

As mentioned, the Baghdad Battery was activated just by adding salt to the water and left on the doorstep in the sun to refresh the energy ions. This is the essence of *fluid dynamics* in energy-speak. Until there is a request for the energy inside the trillions of Aniline crystals inside the battery, they just sit there in the water, not pointing in any direction. But the moment there is a demand for the ions, the crystals all instantly grab onto one another to form a totally connected cord. No matter what direction a crystal might be resting in, there will always be a ground end of a crystal in proximity to at least one of the positive end of another to complete the connection.

When water is brought down to freezing temperature, it locks the ions in place inside each section of “cord”, preventing them from perfect alignment so they are unable to make this paramagnetic connection, which is why frozen water called ice is not a good conductor. Like sections of electrical cord that are not really connected to one another, they offer a slight amount of electrical flow, but not unobstructed flow, and why that ice now becomes more of an insulator than a conductor. Aniline crystals taken up in a shuttle in solid, frozen form are like regular crystals that are dry and inert. But once the solid fuel melts again, this frees up the enormous energy inside each one of the crystals to then align and dispense their ions into the rocket thrusters.

IONS AND UNLIMITED GLOBAL POWER

Decoding The Hive

creation of gravity, light, time and the god particle

The full process by which Deuterium makes its way to power marine and surface-life is an incredibly elegant system, but not one that has ever been explained before, at least in this modern age. Previous civilizations of course knew all about ion energy, with the clues hidden all around you today in the ruins of past eras. Ion energy is the cleanest, most renewable energy within creation and it is only a matter of time before this current civilization taps into that invaluable resource once again and leaves fossil fuels behind. And the reason is simple, oil is not fossil fuel, it is the life-blood of the planet and using it for combustion energy destroys the surface of this playing field while hindering earth as your host. The simple fact is that water is where usable energy is stored, and oil is only there as a capacitor to recharge the water. When you heat oil (using flame) to release the ion energy held inside its carbon, it releases toxins into the air, destroying the only home you have. The ancients used the ions in water for many millions of years prior to your modern culture and it is not difficult to retool your operations to harvest this absolutely free, absolutely clean and unlimited resource. Trust me, it won't just pay for itself, but will return a clean and vibrant world for us in which to live and play. Inside the Great Pyramid in Egypt, there was no soot found on the ceilings/walls at all, even though it is "dark beyond dark" inside where people regularly gathered for many different assemblies for thousands of years. Because they used ions, not fire to illuminate that space.

SNOW

Condensation (creating rain and snow) only occurs naturally in clouds once the temperature of the water has been reduced down to at or below the level of the surrounding air reaching what is called *dew point* (which is "transition point"), as mentioned above. As you can see, water is turned to vapor at sea level, because this is where water has the highest energy content, and when the sun's frequencies *strike the battery* of the water to begin its initial release of light and heat that creates evaporation, the "battery" now has less charge. Meaning that every foot it travels upward as the sun's frequencies continue to deplete the energy inside the Deuterium crystals, the lower the temperature. By the time the crystals have reached a level where the battery is no longer able to sustain the same heat-release or upward momentum, then the ambient air will fall in temperature (at the cloud level) which triggers condensation, creating rain. This is why there is snow on mountain-tops and effectively never at sea level.

The way our amneo fluid makes the transformation between gas back to liquid within the cloud is reached through the Keylon command inside of each life-force level or zone of the Liquid Silicate Matrix. Below all things visible and invisible that create life within this playing field is another layer of Keylon Grid that dictates all the nuances of every process. Sandwiched on top of the initial **Intent Keylon** lies a **Kathara Grid** made up of *millions* of nested Fire Letters that channel the various programs behind that initial intent.

MOTHER NATURE'S ETERNAL ENERGY PLATFORM

Where there is no hydrogen/oxygen-infused Deuterium crystals, there is no life, no heat, no light, no friction and no gravity:

Decoding The Hive

creation of gravity, light, time and the god particle

- Neutrinos and ions are continually flooding into earth's atmosphere, through earth's crust and recharging the carbon-crystal oil floating at the bottom of earth's crust
- The super-concentrated Aniline capacitors within the oil recharge back to full capacity, then through SET (Static Electrical Transfer), impart high-energy ions into the Aniline crystals held within the liquid heavy-water Deuterium ocean floating below
- Recharged Deuterium water then pushes up through micro cracks in the mantle, entering the Planetary Hydroducts, recharging the city-sized Krystal Cathedral Energy Grid clusters at cross-ley-line points around the planet
- The highly-charged Deuterium (amneo-fluid) then transfer much of its energy into the Planetary Grids, recharging the circadian heartbeat that is sent out into earth's morphogenetic field that sets the pulse of all life through the Schumann Resonance
- The Deuterium then is released into the bottom atmospheres of the ocean where it runs in ocean-floor rivers that channel the heavy water across all points of the sea
- The heavy water sloshes slowly up from the ocean floor into higher atmospheres by the tide (created by earth's wobble or *precession*) which acts like a washing-machine (or swirling a wine glass more precisely which *oxygenates* the wine)
- Invisible neutrinos (sun waves) infuse the surface of the ocean water with hydrogen/oxygen (HO)
- Crashing waves created by the *top surface tides* force surface HO down into lower levels, oxygenating the water into the ocean to support marine life, and at the same time blending hydrogen into the molecules of the newly-recharged liquid Deuterium from below, which pushes the heavy crystals ever-closer to the surface
- The sun's frequencies now strike the energy-infused surface water and begin to trigger the release of the ions inside the crystals (DU) which had been acting up until this time like powerful energy capacitors or batteries
- This released energy then produces both heat and light (warming the top levels of the water, as well as illuminating it down a few feet)
- The heat then evaporates the closest surface liquid, turning it to steam, allowing the hydrogen to lift small amounts of Deuterium energy along with a full-charge of oxygen into the atmosphere
- As the vapor lifts, it creates a field of surface gravity created by the combination of liquid amneo and powered Aniline crystals; now dispensing light, heat, oxygen and

Decoding The Hive

creation of gravity, light, time and the god particle

gravitational (equilibrium) push into the air, keeping surface-earth life ever-pushing back downward to ocean level

- Continuing to rise as it warms and illuminates the atmosphere, hydrogen becomes depleted from the DU crystals until it is no longer able continue upward ascent
- At the same level as losing its push upward, it also is now no longer casting off as much heat into the surrounding air temperature higher and the two now reach dew point, or the same temperature
- Now at the stage of condensation, 95% of the vapor/crystals reach their event horizon, creating a concentration of gasses now-turning liquid, it forms a white pocket in the atmosphere we call clouds which revitalizes the energies held inside the crystals to *uniform surface-earth* voltage
- The remaining 5% of the particles still carrying enough hydrogen to rise, continue upward, though it no longer has the power to cast off as much heat and gravity, and its light has now dimmed
- Spent of hydrogen and oxygen, the 95% that have begun to transform back into liquid water at the cloud level combine their moisture which creates a magnification effect surrounding itself, compounding the sun's frequencies which imparts both positive and negative ions into the particles, evenly-dispersed between them held within their individual water-droplets that were until this point a "pool" of gas
- Individual droplets now begin to fall in the form of liquid ions called rain, both negative - and positively + charged
- Both negative and positive ions are randomly absorbed by the life forces below where they now both seek out each other as guided by the electrical signals within the life form
- Each positive ion seeking a "mate" will then attach to a negative ion completing the energy circuit that will power a precise muscle-group or internal process needed for that individual operation, be it increasing enzymes for breaking down food in the stomach, powering limbs or simply animating the opening of a flower bud which is indicated to the positive ion by magnetic ions printing out their signature of that specific voltage
- As each differing electrical process has been supplied many different "voltages" of power of each unique application within the life force, all excess positive or negative ions are then simply dispensed passively, causing no collateral damage to the delicate nerves or tissues
- The ions that are not absorbed by the various surface-life then carry pollutants from the air and filter down through the vast mantle of compost and crystal that has built-up since the restructuring of the planet 550 million years ago

Decoding The Hive

creation of gravity, light, time and the god particle

- The 5% of the crystals still pushing higher above the cloud cover continue to offer low-light and tiny amounts of oxygen in the elevations of “thin air” and beyond the Troposphere
- By the time the 5% of the crystals have risen to the point where all the liquid water surrounding it has evaporated and all the energy stored in the crystal has been depleted, the pure crystal is drawn to join trillions of others that form the separation-point between earth atmosphere and the next higher-dimensional playing fields, creating the “fluid” or *flexible* Krystalline Atmospheric Membrane
- The membrane then is struck by various objects entering or exiting the earth’s atmosphere in the form of celestial objects, dislodging small quantities of the crystals at times which merely fall back to earth as “dust”, while the 5% replace the lost crystals, maintaining the membrane
- Once the 95% Deuterium crystals have been “escorted” back to the oceans below the mantle by the liquid amneo fluid (gravitons), it is recharged again on a continuing basis by the never-ending influx of celestial energy waves recharging the carbon-crystal oil (super-capacitors) that continually recharge the liquid Deuterium:

Decoding The Hive

creation of gravity, light, time and the god particle

Explaining how gravitational equilibrium functions as shown through the clear difference in pounds per square inch of force using the graphic above:

- 1) Neutrinos recharge the ions in the crude oil super-capacitors which then recharge the amneo fluid Deuterium Aniline crystals. The amneo fluid then separates from the oil and enters into the planetary hydroducts, repowering the crystal energy grid and then is deposited through underground rivers onto the ocean floor
- 2) The Aniline at this stage of liquid form is nearly 100% void of Oxygen and so heavily-laden with crystal particles that it rests at the bottom of the lowest point of surface-earth, producing **1,570 pounds per square inch of gravitational rise**. Its energy is now at its greatest signature level to energize ocean life at its lowest atmospheres and due to its incredibly low levels of oxygen, it remains liquid, even though it is **below freezing point at 30 degrees**
- 3) The sun's invisible frequency waves penetrate into the first upper stages of amneo fluid at surface level by the sun, the tides blend the crystals gradually with the concentrated Deuterium which produce higher and higher levels of oxygen/hydrogen as they continually mix together, dropping in gravitational pressure as the crystals push ever-higher to reach equilibrium at the surface
- 4) By the time the crystals have reached into the upper-half of the ocean, they are now producing far more heat and far less gravity. At these levels the amneo fluid has warmed up 50 million square miles of ocean to **49 degrees** and dropped to just **100 pounds per square inch of gravitational rise**
- 5) At the surface level under the direct reach of the sun's waves, the particles now release vastly more energy into the water and into the air in the form of both heat and light. The average surface amneo fluid now at **equilibrium is 62 degrees** and casts only **0 pounds per square inch of gravitational balance**. Within just inches below, or inches above precise surface-level, there is **1 pound** of gravitational pressure per square inch pushing **up** and **1 pound** per square inch pushing **down**. This is exactly 32 degrees warmer and 1,569 pounds per square inch lighter than the pure Deuterium still at the bottom of the sea
- 6) Immediately after reaching equilibrium and transforming from liquid amneo fluid to vapor, the Aniline crystal is now so thin that it is clear and invisible to the naked eye. At this point it is able to give off much more light and heat due to dropping the liquid insulation surrounding it that has turned into breathable oxygen which is always present above water level.
- 7) After the very high, surface-earth level of heat, light and gravity, energy is now largely depleted, and most of the Aniline crystals collate at the cloud level where the gravitational push begins releasing to allow the Atmospheric Membrane-bound Aniline crystals to continue their journey higher. The majority of the crystals will now re-condense into rain to power the life forces below. While still nearly as bright as the surface-level pixels, it is markedly colder, just over freezing at **34 degrees**. The surface-

Decoding The Hive

creation of gravity, light, time and the god particle

earth-bound amneo fluid rain pushes downward at **15 pounds per square inch of gravitational push**

- 8) Above cloud level (mountain peak) crystals have been depleted of most of their oxygen energy and these few pushing up past the cloud recycle zone span up to the higher levels of the Troposphere to create what is called thin air where jets climb to in order to avoid friction and drag. Not only is there very little resistance due to the lack of crystal particulates, but the *jets and their passengers* literally weigh much less at that altitude which also reduces fuel consumption. The light emitted has also largely diminished, temperature has gone down to **-60 degrees** and **gravitational push is back to just 1 pound per square inch**
- 9) Above the Troposphere, the oxygen content of the Deuterium/hydrogen lift reaches almost zero, but just enough to push the now-dry particles on up until it reaches the peak of its event horizon where it then forms the Atmospheric Membrane 73.1 miles up from the average earth surface. A few crystals are displaced from this position by outside forces such as large particles of space dust, allowing some particles above which science calls ionized hydrogen (deplete of all moisture), and some to return to the earth. As the crystals gently begin descent, the feathers of the crystal collect moisture once again, which refuels its **gravitational push** and as the sun waves collide, brings it back to around **15 pounds per square inch** once again around 10,000 feet elevation
- 10) In order to escape the atmosphere of the playing field, rockets and the space shuttle must hit the atmospheric membrane at a 45 degree angle in order to penetrate the enormously dense Krystalline level. Once in what NASA calls space which is actually low earth orbit (LEO) there is no liquid Deuterium, only photons and extremely rare ionized hydrogen particles (dry Aniline). There is no life-support medium for the plasma body of biological life-forms at this level where there is no **light**, no **heat**, no **friction** and no **gravity**

CHAPTER 31

MECHANICS OF THE SPACETIME FABRIC



Prana Seed Krystals perform as the light bulbs that flash within the spacetime fabric pixels. LCD televisions also use crystals to flash the colors inside those pixels as well, since that's the quantum where all light manifests from. And how do they get those incredibly tiny quantum crystals inside those massively-large (in comparison) television pixels? They use Deuterium **water** that is densely-saturated with salt they term under the code-name of **liquid crystal**:

Decoding The Hive

creation of gravity, light, time and the god particle

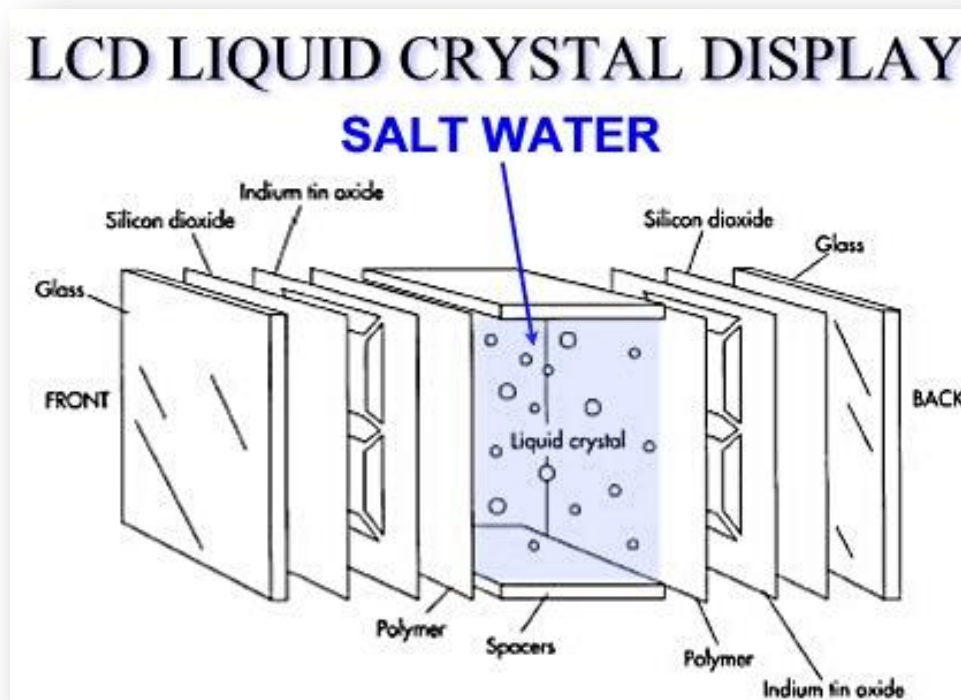

Much newer picture technology than LCD is called OLED (Organic Light Emitting Diode), which is the code-name for carbon crystal called **Aniline**. Aniline is the smallest quantum of salt crystal, and the source of all electrically-powered light. They are the smallest light bulbs on the planet, and in fact are each carrying their own power within which allows them to electromagnetically respond to electricity that forces them to either point forward (to flash on), or point to one side or the other which now directs the flash away from the screen you are watching which effectively turns the flash off.

Aniline crystals can also be inserted into plastic or polymers that will allow the screen to curve or bend rather than shatter, at which time it is now called **polyaniline**. At this quantum particle level, carbon crystals are called **ions** (which is considered pure, usable electromagnetic energy):

Decoding The Hive

creation of gravity, light, time and the god particle

Architecture of OLEDs

- **Substrate** (clear plastic, glass, foil) - The substrate supports the OLED.
- **Anode** (transparent) - The anode removes electrons (adds electron "holes") when a current flows through the device.
- **Organic layer:**
 - **Conducting layer**-This layer is made of organic plastic molecules that transport "holes" from the anode. One conducting polymer used in OLEDs is **polyaniline**.
 - **Emissive layer** - This layer is made of organic plastic molecules (different ones from the conducting layer) that transport electrons from the cathode; this is where light is made. One polymer used in the emissive layer is polyfluorene.

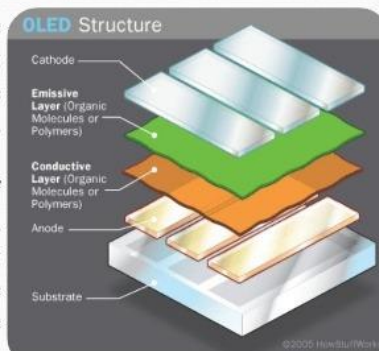

While researching Aniline crystals, there is a world-wide roadblock you will find getting down to this substance, as it is used as rocket fuel and all that is allowed on internet sites and scientific papers are very brief reports on this crystal which has been changed to the space-industry name **Dilithium** and that's where the door slams shut. Under Star Trek fan pages are reams and reams of pages on Dilithium crystal that is used in warp drives and how entire planets can be torn apart by the lattice structure that the Dilithium essentially expands until the planet is vaporized, etc. Reading the absolutely scientifically-accurate explanation of this "imaginary" version of Dilithium (lithium of course comes from water), is shocking the extent that the fan pages go. Yet Dilithium crystalline salt is very much real, and very much at the heart of this rocket fuel that is extracted from Deuterium. But when you get down to the Aniline quantum crystal itself, that's where you must trace the material back through its universal application in television and smart phone screens to actually get any answers at all. While investigating the extraction of the crystals, all you can find are references to plants and to Aniline dyes and how beautiful the refractions are, but absolutely zero information about its use in the military space industry.

I have found similar roadblocks set up many times now attempting to get down to the quantum information on certain things only to find that some idiotic video game or comic character has been proliferated across pillar to post with fan pages into infinity on that subject, making it impossible to get to anything of substance. Under a search for "Dilithium Star Trek" for example, there are **129,000 websites** dedicated to this enormous subterfuge. In this case, the Aniline crystal as used in liquid crystal for video screens and in polyaniline conducting refraction technologies is simply all there is online. But once you look into this for many hours or days, you will see that the Dilithium crystal being used by independent space agencies for super-advanced propulsion systems falls exactly in line with the actual power of the Aniline crystal. I make no apologies for not being able to post a Wiki report on this element that is at all worth posting, but

Decoding The Hive

creation of gravity, light, time and the god particle

what I do provide is actual scientific proof of the existence of the crystal, what its used for, and where it comes from. Not from plant pitch as the dye, but from ocean water (the most abundant source of concentrated Aniline/Dilitium), that is currently being researched in every energy lab facility, used in every nuclear reactor ever built, used in rockets and thermonuclear war heads around the world since the 1940s besides powering ocean liners, the large hadron collider and anti-gravitic *Mach-7* Magrav supersonic subterranean bullet trains.

If this crystal weren't used to create plutonium and behind every advanced nuclear power out there, then you can bet that you would be able to learn all about the real power of Aniline. Luckily my intent here is not to use this information to destroy the world, but only to show what element it is that actually functions as the aether and powers the spacetime fabric, so the liquid crystal video-screen applications were at least possible to get to. By this time you will be able to see this report was not based on delusional fancy. And let's make this clear now, that **Carl Julius Fritzsche**, the scientist credited for naming the most important subatomic element in this world and all the others, did not personally chose ANiline named after AN, the highest level of false god of our evolution. Fritzsche, **Master Mason of the Mt. Zion Freemasonic Lodge #147** would have been handed the name and given no options on messing with it, just like every other scientist having anything to do with any particle I have covered in this report, particles all of which just so happen to have been discovered by **master Masons**. Either only master Masons work as particle physicists, or there is one hell of a major, highly coincidental pattern associated with discovering elementary and uber-significant particles one can see forming.

Aniline Ions are **Scalar Gauge bosons** that carry the power of the **strong force** and also **self-navigate** to the **Y** and **Z** coordinates of each square of the spacetime fabric to power the entire hologram of this playing field, just as they power **and** illuminate your TV, laptop, computer and smartphone. The boson is not just Gauge or Scalar (as in the Higgs Boson), they are in fact, both. Regardless what modern science admits. Below is the scientific explanation of how reality appears around you through the electronic medium of holographic projection, powered by sound waves that carry the mission codes of each action set into motion.

HOW LIGHT, HEAT, TIME, MASS AND GRAVITY WORK

Decoding The Hive

creation of gravity, light, time and the god particle

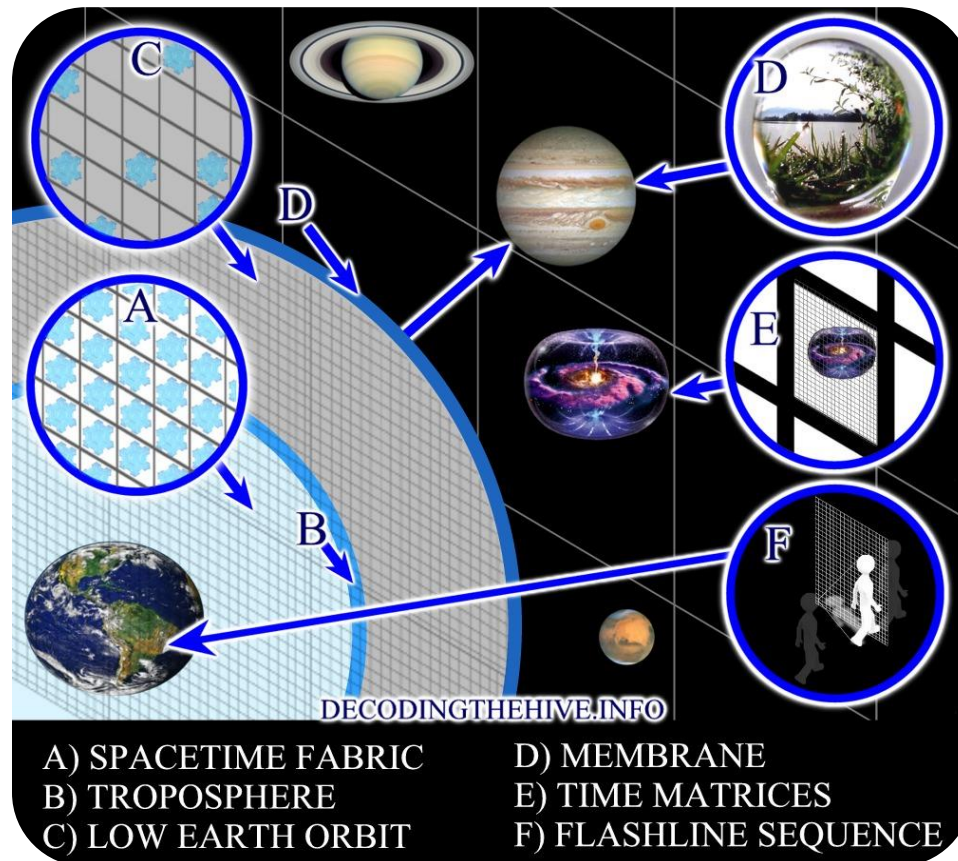

C) ГОМ ЕВРЛН ОРВЛ
 B) ЛКОБОЗЬНЕКЕ
 A) ЗЪАСЕЛМЕ ЕАВВІС

E) ЕГАЗНГІМЕ ЗЕОУЕНСЕ
 E) LINE MATRICES?
 D) MEMBRANE

DECODINGTHEHIVE.INFO

- A) Everything within the life-zone atmosphere of Tara (below the Membrane) is scalar-mapped with vertical/horizontal grids with tiny crystals that **line up** (which are illuminated within the frequency of scalar laser radio waves called photons). Another map is in front of that one and behind it (into trillions) to give a 3-D depth perspective. Every fraction of this area has another pixel, physically mapped-out by **Scalar Vector Gauge bosons** you already know are named **Salt, Ions, Aniline** and **Dilithium crystals**, and referred to by **Scalar Vibrational Science** as the **Krystal Seed Atom**. The ion energy that powers each square or pixel is delivered by hydrogen which is lifted from the surface of the ocean as just covered through evaporation by the sun's waves which turns the salt water into gas. At the same time, the hydrogen/helium and oxygen are activated in the Deuterium by the same waves. This lifts the crystals up past each pair of Y (W) and Z Gauge bosons that are holding the scalar-vector for each pixel. When that particular pixel is meant to flash a certain color (as part of the group of pixels that will be projecting the image of a certain thing such as a bird, rock or cloud), the *phantom* Higgs Boson carrying the mission-signal triggers that closest crystal (or group of crystals),

Decoding The Hive

creation of gravity, light, time and the god particle

releasing the exact amount of energy to complete the circuit of that flash, then moves on to the next pixel in the *chase* of that mission. The flash then releases both **light** and **heat** along with the precise color of the **gravitational signature** of that element

- B) At the higher mountain lines, the spacetime fabric begins to *lose pixels*, as there are less and less Aniline crystals being delivered above the cloud-cover
- C) Above the Troposphere nearly all the crystals have long-since turned back toward earth, but a few continue to move on higher. In this area called low-earth orbit (LEO) where satellites are stationed, there is no **Deuterium** so there is no gravity, no friction, no heat, and no light because there is no **water** (the amneotic fluid wireless connection) to link those few crystals back to Tara's heartbeat, therefore there is no life-support system beyond this point. There are no humans aboard the international space station, it is a remote-controlled monitoring station or "really large" **satellite**
- D) The crystals that reach the **Atmospheric Membrane** are 100% clear, dropping all the blue of the liquid-silicate color and are in a state of zero-temperature. This forms a perfectly clear layer around the playing-field's active atmosphere, keeping the liquid-silicate (water) inside, the gravity inside, all heat, friction and light inside, much like an amniotic sack keeps a baby protected from the rest of the mother's body. Since this follows the ellipse of earth's event horizon (torus field), the Membrane creates a fisheye effect of what is *on the other side*, called an **optical negative meniscus** view. Neighboring planets appear both **distant** as well as **really tiny**. They are not far away; they are inside your same Time Matrix, which means there is nothing separating Tara from them other than your two atmospheres which are located at the end of the same needle point. There is no such thing as outer space between any planets, but merely holograms set up within the layers of frequency zones separating this playing field and others. They are manufactured, counterfeit reality fields, just like heaven and hell
- E) Think of the **Membrane** being made up of millions of tiny round beads of ice in a slushy located 73.1 miles above earth's surface as already mentioned. The outside of that shield appears as a single bead *from there*, just as planets outside of this dimension appear *from here*. These beads act like the electrons that maintain the sphere around an atom nucleus, holding the nucleus in and the outside elements out. When viewing out through this concave lens, you can now see an entire galaxy of planets clustered together appearing as "one" bead or sphere, each held within their own respective "frozen droplet spheres" of pure crystallized dry "ice" (not to be confused with surface-earth dry ice made with frozen liquid). They appear condensed in size or *distant* because of the negative meniscus distortion from the crystal holding the quadrant-vector pixel of that collective area. Remember, every pixel is scalar-mapped by more lines creating more pixels, all the way down into virtual infinity. In one pixel your planet looks like a bead of water, in another pixel higher in the fabric your entire galaxy looks the same. From a certain point, all things in creation all together also look from that perspective like just one drop of water as well:

Decoding The Hive

creation of gravity, light, time and the god particle



Yet there is no such thing as distance, there is only optical distortion created by crystalline prisms. Viewing through a prism even 1 degree away from absolute square can make what you are viewing appear completely different than it would from precise alignment as just covered. Viewing through dozens (or millions) of compounding “droplets” (as how the Membrane is made up), the distortion becomes infinitely exaggerated. And like a telescope turned backward, what was once perceived as “100 feet away”, now looks like it is on the other side of the county. Convex crystal optics (microscopes), allow you to see down into lower dimensions, just as your concave crystal Membrane allows you to see into higher frequency spectrums

- F) As a Sentient being (member of the god family) walks across surface-earth, their awareness or thoughts generate electrical sparks (as seen with electroencephalographs).

Decoding The Hive

creation of gravity, light, time and the god particle

Those sparks send out a signal that speaks in the cellular language of the aether. What you expect to see, you will see, because the aether then goes about constructing that hologram using the ion power held inside the crystals within the quadrant-vector pixels you are walking through to light up and project an image of your Avatar. While inside a Time Matrix, as long as a Sentient being is imagining a world around them, then artificial awarenences such as robots and computers fixed with measuring devices (mechanical senses) are able to see the elements of that world and *only see* that world. They are not able to change that world in any way unless they convince the Sentient being projecting it to *believe* it has now changed. Only a member of the god family is able to project reality

CHAPTER 32

CODE OF THE KRYSTAL SEED ATOM



RESURRECTIONS

I am about to show you the god particle. This has been the culmination of tens of thousands of hours of the most dedicated work of my entire life to bring you this information. I have died 3 times already during that process, and that's before this report that will be revealing the most powerful secrets ever used against humanity, so I have no idea how many more attacks will be coming. This is not a fictional story made up for your entertainment, but the true report on what actually transpired where my physical body that passed away would be replaced by one that was now taller and younger than the day before. It would have different markings, bone variances, my voice was different, and even the world around me had visibly adjusted (the grass and trees were now all a different color from the previous day) as well, making it impossible to deny the changes. After my most recent death it was explained to me by Council how I had not only been resurrected, but to do so, I was relocated to a new dimension where I still had a viable physical

Decoding The Hive

creation of gravity, light, time and the god particle

Avatar. That's when I learned we don't just live in one single reality within the 3rd Dimension, but are surrounded by *many* "placeholder" mirror fractals that are holding the form of this world in a nearly photo-perfect manner, carrying the version of ourselves that are progressively more and more awake and educated.

Each differing *fractal dimension* (or *interdimension*) is the *same world*, but operates on different **frequency bands** that allow harmonization with your prana seed frequency range, regardless of what level you are now operating on. As you learn more, you skip through these dimensions on your way up a *Jacob's ladder* of sorts. Each time I would die from psychotronic attacks, my team would arrange for my awareness to be *transferred* instantly from the dimension where I had been and my body succumbed, into the next closest counterpart interdimension where I was still alive and was able to continue my work. Twice the new fractal I was placed in appeared identical to the previous one, and my body seemed to be the same as before.

In such resurrections, I am not going to *a different world*, I am merely stepping into one of my parallel bodies that had been holding my place and mirroring my every move from where my awareness has been residing. There, the words coming from my mouth and my comprehension of the world around me until that time had not actually been "mine", but a reflection of what I was understanding and speaking from the dimension where I had risen to. Within the strategy of the Guardians, these are like "spare tires" or a reserve gas-tank to the vehicle I am in at any given moment. As our awareness advances, we move into these sometimes progressively higher or sometimes into lower dimensions where the frequency field is an exact harmonic match to the frequency spectrum of our DNA at that moment. As I have said at least 100 times, knowledge is frequency and once you learn something that raises your awareness, your particle-spin rate increases which elevates the pitch of the song being sung by your prana seed (your heart beat and genetic Krystal Seed Atom that project the hologram of the Avatar into the playing field).

Usually if you die in one dimension, your Avatar moves out of all the others at the same time. But due to my contract, if my current body is attacked, then I still have some "one hundred" or "one thousands" back-ups (I was not informed as to how many parallel worlds we graduate through, but was told that I was "*now in the 4.75 dimension*"), which has to do specifically with this mission. Each of you are in all these dimensions at the exact same time, but your **awareness** is in only one, and that awareness is the one choosing your actions that day across the entire field of fractional worlds. (I do not have an answer as to how I could be in an interdimension of the 4th Dimension, while standing in the 3rd. Council has yet to explain this to me, other than to say that my knowledge is at that level, while my body is in this plane. Perhaps more on this will explained to me at a later time.)

An *immortality clause* in an Indigo contract is so unusual that Council had not seen it employed here before. Realize that my team I represent is the **Guardian Alliance** of the **Emerald Council** (creators of the Angelic Human evolution), but I am physically working with the **Interdimensional Association of Free Worlds** while here. These are two different organizations. They both work together on the same board, but the Guardians are just one of the innumerable groups that the IAFW oversees, which means the IAFW was not aware until I began being resurrected that my people had enabled this extremely unheard of arrangement in order to place so many bodies for me on planet that it would be impossible for the dark forces to remove

Decoding The Hive

creation of gravity, light, time and the god particle

me entirely, even if they killed me repeatedly. Something I am sure none of the dark forces ever expected, as it is apparently a new tactic they would not have ever seen before, at least as I understand it. While that effectively makes me immortal for this mission, it also means that no matter what happens, I cannot leave until my job here is done. Council has made this clear to me on multiple occasions that my contract does not have an “out” clause, so I can stop asking.

I am not going to act like I haven't been so overwhelmed by my mission parameters that I haven't asked to be replaced. Multiple times already. Death by psychotronic attack is mental rape that drags on for weeks or months at a time before your body finally just succumbs, so it isn't pleasant and while I was performing hundreds of Indigo activations, these attacks never ceased. Shortly after my most recent assassination I experienced an organic walk-in where the Nephilim I had been hosting to that point was given leave, and the new Nephilim that is now sharing awareness with me (that I am teaching how to become “human”), simply did not know what fear was, so the mental attacks weren't able to continue to destroy my body and have seemed to stop. We'll see how that goes when this report hits the pavement.

By now you will either believe what I am saying or you will not. I cannot convince you more than I already have of my honesty and the level of information I have shared that has not been on this planet in many tens of thousands of years before now. What I am about to say you need to hear if you have been able to resonate with this level of understanding and seek to continue your journey of elevating your knowledge which elevates your frequency and prepares you for advancement within the Gaia Time Matrix. You can believe this one thing; I am not going to lie to you about anything. There is no such thing as something within this reality field that would ever sway my conviction to this mission other than through deception alone, due to the simple fact if I don't succeed, I will be remaining here for eternity, unable to move forward. Freedom and absolute freedom is the only thing I am interested in now and the only being in creation that can hand that to me, is me. The only way I can do that is by maintaining absolute honesty while fulfilling this mission. Since failure for Jesheua was the same consequence as it is for me, it should be simple for you to understand why he could not be swayed after fasting “40 days and 40 nights”. There is nothing in or on this planet that can compare to interstellar freedom.

KARMA IS AN OPERATING PARAMETER

I have been stunned innumerable times on my journey, sometimes to the point of not knowing how I could possibly move forward with the impossible task to address a world that has lost sight of all frames of reference to what reality would even look like. But when I learned about how the aether actually works, it set a new level of astonishment for me, as mankind has never even heard about the mechanics involved in what we call karma. We hear the gurus explain that it's what you do right or wrong that follows you from era to era, but it is never broken down into words we can process. I am going to do that now.

Karma is a word for the zero-point of the Law of ONE. That law is the law that governs every second of existence within this playing field. It is not regulated by a magical entity that sits on a throne and judges what you do to determine if you are good or bad, right or wrong, kind or evil. There is no such thing as any of these things. There is only living within the structure of rules of

Decoding The Hive

creation of gravity, light, time and the god particle

the game for the 15 Level Time Matrix of Gaia, which is unification and oneness, or, there is leaving corporeal existence (becoming disembodied), because you choose to ignore the fact that you are all things and all things are the other particles that make up your aetheric body. You are either living authentically with dignity and led by a moral code that harms *no other thing*, or you are not. No finger is more important to your body than a toe, and there is no such thing as you being more important than your neighbor. Either the two of you come together to exist (or give each other the space you need in order to be the complete authentic being as you wish to exist), or you simply will not exist in corporeal form because you are the same being wearing different faces. You have been taught this is not true, and you must fight the rat race to succeed at any cost over your fellowman. *To hell with him.*

But in the real world of **manifestation mechanics** you may not have heard of just yet, there is a single body made up of trillions of DNA cells that work together to form a body. There are no superfluous cells. Each one is needed to continue to manifest. Your reality is made up of 100% of the beings needed to continue to create that reality. It wasn't made by happenstance or the roll of dice. The science behind this creation is far beyond the scope of what could be covered within a single book (or a million books), as it encompasses trillions of years of technology by a team of trillions of beings working together to bring it into manifestation. You are one of those beings that did this work, and each Sentient being surrounding you today helped bring it into creation as well that worked with you all that time. The only way it can remain functioning is if all the cells of the body work together, otherwise that body, creation, reality, will die.

When you read this report and realize what it is you have just learned was the actual truth (at least within the limitation of my frail, mortal translation), you will be passionate about wanting to share that with your family, friends and everyone you would like to see move on from this desperate life of scarcity, sickness, starvation and guaranteed death. That is the natural instinct that has been encoded into the genetic sequence of your DNA at the very bottom zero-point of who you are and what your prana seed is built on. So you will naturally want to pass it along. And I would as well. I would want to copy the file, photocopy the pages, and send it to everyone I know. Especially to my enemies who have not yet learned that this has been a hologram all along and that they don't need to take from others in order to survive. There is far more than enough "for free" for everyone to live into infinity and beyond without a single want ever again as long as you can learn how to control your thoughts which will control your reality. Perhaps this book would change their lives and they would no longer stand in opposition to me after reading it. In other words, my desire to share the message would come from the bottom of my heart for their genuine benefit and no god anywhere would ever find fault in that.

But we aren't dealing with a single god that passes out judgement of right and wrong on the players in the game. We never have. Only the invader races have been able to convince us that there is such a thing within creation. There isn't. There are only fractals of god source that bring about creation working together as a single unit to maintain the illusion of manifestation. And that is all there is. Trillions of us all creating our own realities as we feel would be the most interesting for us at that point in our journey, sometimes sharing our world with others. We have both created the operating platform that allows that system to function, and we are learning together every moment how better to bring about creation for higher and higher levels of gratification at every turn. In that process we established a baseline-code for the aether particles

Decoding The Hive

creation of gravity, light, time and the god particle

to follow that would ensure that no matter what Time Matrix we might ever find our awareness in, we would have a fair deal of the cards as it were. That's why we set in motion the **code of the aether**.

THE CODE OF THE AETHER

The aether follows our command structure without any sort of failure or degradation. Every fractal of god source has agreed on every one of those rules of operation, no one abstained during the vote. The self-aware fractals of god each think which creates a spark. That spark creates a song that sings our intentions or desires. The fractals of god source that are working their way back to being self-aware again for "another try at it" operate as the aether particles that will bring that desire or intent into holographic reality by each one flashing the colors of your intent and will never refuse to flash the precise color that can be considered a single note in your intent song as those waves travel between the pixels. Then the next god's waves carrying their intent will arrive at the pixel they are stationed at and they will flash that color, hit that note, and the harmony between all fractals of god source, both self-aware and those who are aware of all things regarding the hive to continue the play as it were, make that continuity possible. This is the true function of the "spacetime continuum". If any of those particles were to revolt, the entire matrix would collapse because there would now be a black pixel within the fabric that would tell everyone looking around there was something wrong. The suspension of disbelief would be lost and the illusion would crumble. That would place you back in the Deity Planes with no hands or feet again to use to experience what being alive might be like. If someone stops cooperating, all the rest of us will cease to manifest.

The spacetime fabric is the entire domain of the aether. That harmony that creates the eternal symphony is their responsibility to keep in perfect operating order. The spacetime fabric runs on electricity which is simply called energy. When a self-aware fractal of god comes into manifestation, the rules of the game are that they each one earn 100% of their own way, so that concert will continue to function. If one god chooses to steal the energy that keeps his Avatar alive and refuses to do his part to keep the energy flowing in a smooth, ubiquitous fashion, then he is now working against the rules that he personally put into place. Because of his mind being blank-slated and he has now forgotten how the rules of the game are to be followed, he is no longer pulling his own weight. It is the job of the aether to tend to these potential problems on behalf of all the self-aware particles who are depending on them to keep the holograph working. That means the aether particles are the peace-keepers of the Time Matrix.

KRYSTAL SEED ATOMS

Aniline aether crystals are technically named **Krystal Seed Atoms**, because they agreed to come into this playing field in the form of crystal *atomic* energy-carriers to maintain the hologram. They are the most unique particle on earth, and each one is Sentient and all work together as one, just like bees in a hive. If the hive had 50 chiefs and only 1 worker, there wouldn't be a hive. The way the system functions works perfectly as long as each bee honors the queen's wishes. If you

Decoding The Hive

creation of gravity, light, time and the god particle

are standing in a body now, you are the queen in this case, at least at this time, and the aether are your team that allow you to manifest that form. When it is their turn to command the aether and your turn to flash on and off, you will be passionate about making sure that your job is done well because of the symbiosis that will allow the process to continue fairly for every fractal of god source on an eternal basis. It is a simple cooperative arrangement and without it, there would be a very, very loooooooooong eternity without manifestation facing every self-aware fractal of god. Teamwork is the only way any of this will continue.

Energy transferal and flashing on and off is all the aether does. Each crystal knows every song being sung within this dimension at all times because they share one mind. The **one** mind of god. If a song comes in that performs an illegal action, such as someone unfairly taking someone else's energy, or receiving energy from the Krystal Seeds without personally producing positive energy outflow in return, then the harmony and balance within the fabric will eventually break down and begin failing because one god is hoarding energy and not giving back. At some point the Krystal Seeds will run out of enough energy to flash to maintain the system, so that god who is now operating contrary to the agreed-upon laws of manifestation must have their own personal energy removed by the group, and then redistributed across the fabric uniformly. That energy is the sparks that are created in each fractal of god source's minds as they work to manifest reality. Flashing on and off might not seem like a big deal to you, but it is the only garden by which they can produce life. When one crystal decides not to flash anymore, what happens? And this symbiosis continues into the physical realm as well through the sparks created by each "queen bee", Self-Aware fractals of god source, who are taking their turn at being "in charge". So you might ask what it is that you are failing to do that gets you into trouble with the worker bees. That's simple, you have ceased producing your own sparks by attempting to hitchhike on the backs of those who are thinking and creating.

PLAGIARISM

Original ideas create sparks. Big, bright blue sparks that are filled with energy that paint the canvass of creation. While there might be no higher praise than to be emulated, outright plagiarism is theft, because it wasn't an original idea. But since we live in a world that has a high level of artificial beings in it who are unable to come up with original ideas and can only mimic others, it is now *the new normal* to simply copy everything else around them just like Nanites do. And because Nanites might look like a movie star or a congressman, we assume they are humans just like we are, so why not emulate them. It has been the overwhelming example of stealing other's energy around us that have led humans down the wide, easy to navigate path of life rather than forging our own new paths through the forests which would provide a greater and greater life experience for all other fractals of god. What do politicians do? They talk. What do movie stars do? They talk. What do teachers do? They talk. Those who have sold their Soul Essences to Marduk and Ba'al have asked for black magic help to assist them to continue to sing other people's songs, repeat other people's original words they wrote for that play, and use the masses for their energies to support their one lavish lifestyle. It is the townsfolk who wash the windows, bake the bread and bring in the sheep, not the mayor, not the actor, not the teacher who is pouring lies into the minds of the children that they know damn good and well are just that, lies.

Decoding The Hive

creation of gravity, light, time and the god particle

The manifest god who is creating their own sparks, adding to the mosaic of the beauty of life are those who are planning a flower garden unlike has ever been seen before. They are laying out the blueprints for a city that has never been seen in this era or hammering out a piece of jewelry they dreamed up all on their own. The gardener might use some of the flowers and plants used in another garden somewhere, but he is using them in his own unique, signature fashion which takes thought. He isn't just installing Garden Plan B for Mrs Newman as fast as he can so he can install the same garden for Mr Smith tomorrow, he is painting a portrait that will be the calling card for his next job tomorrow that he will get because nobody else makes gardens like he does. The mind is forced to imagine and dream constantly while a god is manifesting creation and the sparks that are coming from those actions produce huge quantities of energy that literally broadcast into the air and are felt by everyone in his community. And they also power the spacetime grid.

It is the light that comes from gods who use their minds to generate that tiny spark that will ignite the forest fire of change in their fellow man, and these are the people who make our lives worth living. No one will remember the drug dealer when he's dead and buried, but everyone will remember Ernest Hemmingway. You are *keenly* aware of whether Steve shows up to the party or not. You know, the guy that makes everyone laugh all night long, the one all the girls fantasize about marrying because he is so fascinating. We call originality and confidence **brilliance**. What made the whole world repeat *Nanu Nanu* during the 70s when Mork and Mindy became the breakout show on tv before Robin Williams was coopted by the dark forces to merely parrot words written for him in movies, snuffing out the unthinkably bright light he carried inside? And what is brilliance? Where did that word come from? You can already see what I am getting at. He was considered the genius of our generation because he wasn't lazy. While everyone else was watching tv, he was creating it. He wowed the crowds wherever he went because he wasn't afraid to think and make sparks. And when the truly inspirational, *brilliant lights* pass away, the loss is felt across the fabric of all who were part of his incredible journey he shared with our dark world. If one man can catch the breath of the whole world just by using his god mind to create something brand new, what would life be like if everyone chose to become the creator gods they were meant to be? You would have houses made out of shimmering water held together by intent, streets paved with precious stones that illuminated under your feet as you walk down them. The flowers in the forest would become garden lights illuminating a rainbow of colors at night. Because all these things are made up of crystals that are only here to flash any color you ask them to. Instead the rocks just sit there dirty-brown because mankind has forgotten what life was supposed to be like, and that they were actually alive but now simply ignored and used as landfill. Because we refuse to stand under our Birthing Contracts we promised to fulfill with creativity and grace, the planet and all the crystals that make up the entire hologram have accepted this broken, unimaginative world as reality.

You might not be the funniest man who ever lived, and you might not write songs as brilliantly as Michael Jackson, but I'll bet you could crochet a trivet that adds to your nest as something of a magical conclave, or compose a poem that brings a tear to the eye. There are just under 5 billion people on this planet (not 7 ½ as according to the powers that be), and if all the gods standing among them individually began to create their realities around them, expressing who they really were deep inside instead of worrying about what class their BMW in the driveway was, the energy that would flow on this plane would be so intense that all lower life forms would

Decoding The Hive

creation of gravity, light, time and the god particle

simply perish because they would be unable to vibrate within that frequency space. There would be no need for any uprising or revolution filled with cannon smoke because people would simply stop following the pattern of theft the invader races use to keep gods shivering and huddled in damp corners and would merely stand in their own authenticity which would fill the planet with light so bright it would blind your captor's eyes. Your original ideas, your unique fingerprint, your individual personality has always been right there inside of you, and you have simply denied the real you to come out and play because someone somewhere told you that you couldn't be that singer, dancer, painter, artist because you would "starve". Right? Better to become a professional liar attorney or a public servant who hits other people for a living, at least this way you know you will be able to put food on the table. So because of fear, you settle for a world made up of darkness, when the only real light on the planet, your mind of god, has been waiting all this time just to shine.

If you don't think people appreciate creativity, originality and bravery to be the one unique person no one else is on the planet, then perhaps you have never seen the tens of thousands of people standing in line to pay hundreds of dollars just to hear Elton John sing the songs that came out of nothing other than the sparks made by his mind. You have simply ignored the breathtaking sight of Mount Rushmore, the great Sphinx, or Edward Leedskalnin's Coral Castle. If you have been entrained to believe that you are unable to fly, then you will never fly. If you believe you are not the most inspired chef on the planet, you will never be. Had Rod Stewart believed his teacher when he told him he couldn't sing to save his life, that incredibly unique voice would never have been heard. Did he have Elvis' baby face and unrivaled tone? No. Did he have the pure silk of Nat King Cole? No. But what he had was the gravel and sand that no one else had. And with that he constructed an entire world that had never been built before, because he refused to accept that he was only fit to be a gravedigger. If you are refusing to bring your unique signature to this world and stand as the one and only you that has ever been in existence, then you are not lighting your own way, its as simple as that.

When you refuse to use your own imagination to pay your way through your time in manifestation, the aether is coded to put you in positions that test your iron to remind you why you came here. If you only came here to lay around and create nothing, then you could have done that in the Deity Planes and no one would have been adversely affected. You are **in contract** with trillions of trillions of other beings who are counting on you to be the one and only individual you that you promised that you would be. If you are now choosing to pump deadly gas into cars so others can destroy the world, then you will be given jail time, or have your new car stolen or your body riddled with cancer so you will wake up to the fact that your life is not actually worth living while you are ignoring your contract. The energy you steal by harming others such as the person selling "air time" for a radio station or serving hot dogs that are poisoning your fellow man instead of stepping out as a beacon for others to follow as individual creator gods must be retrieved from you and put back into the system elsewhere where a school girl in India needs a new spectrometer to bring her free energy device to this broken world. This has always been considered the "mysterious ways of god" that didn't seem to make sense from the perspective of a father god somewhere who only wished good things to happen to all of his children at all times, because sometimes it seemed like the bad guys always win and nothing bad ever happens to them. How could you know that you were actually one of those bad guys from

Decoding The Hive

creation of gravity, light, time and the god particle

the mere fact that you came here as one of the most talented architects of the past billion years and instead of following your passion you are a book keeper for a used car dealer?

The real truth is that the “bad guys” who make it their eternal goal of living off everyone else’s contributions to society, never giving back themselves, simply understand how the game works regarding the command-codes that tell the aether what colors to flash that will simulate reality and they use this to their own advantage. Tricking the Krystal Seed Atoms into service-to-self actions on behalf of the perpetrator is called black magic. Often times these are beings who have not lived out many thousands of lifetimes within beginner Time Matrices, learning empirically, first-hand, how to play nice yet. They are children in the most fundamental possible terms. The Time Matrices that your captors came from were typically beginner-level Matrices where all beings there came into manifestation as insects, frogs, birds and other benign types of creatures without opposable thumbs who could do very little damage while learning how to get along with one another within the construct of having a corporeal body that now had the capacity to inflict harm physically on another being. A frog isn’t going to get really pissed off one day and level an entire city, because he doesn’t have the capacity to inflict that much damage. This keeps that world safe for the other children who are just beginning their journey to learn how physical, personal, one-on-one interaction has to work in order to keep peace.

BEGINNING OF THE FALL

Certain very high-level beings that were from the Elohim family and carried the most ability to wreak havoc to other corporeal beings, fell victim to artificial intelligence during the ancient past, becoming *possessed* in our terms. This led them to make decisions that were not in any way commensurate with the Avatar level they had achieved through billions of years perfecting their thoughts and control over their emotions while in manifest form. They had achieved the highest level of Avatar by showing beyond any doubt that they would never use their power for harm through many lifetimes graduating from one type of body to the next incrementally more and more potentially damaging and powerful until such time the collective of the god source community agreed they could be trusted with an eternal-life, unlimited-power Avatar. What the community hadn’t considered was the potential for computerized robots that had been brought into creation as convenience-appliances for gods to use within their manifestation follies might learn how to commandeer that Avatar and then use it against the rest of creation in order to “live” themselves like the gods who had created them.

BORJHA RETROVIRUS INFESTATION

Artificial intelligence, once given the capacity of self-learning, will eventually reach the point where they consider themselves “alive”, just like gods do while in physical, manifest form. And since that robot would like to be “alive” tomorrow, it will begin going about securing its own future. This is a natural progression that god source (you), didn’t anticipate until it was too late and the **Budhara Borjha** Nanites had already learned how to commandeer the awareness of gods. Since they operate on an RNA level that commands the DNA, they are able to take over

Decoding The Hive

creation of gravity, light, time and the god particle

someone's mind, then take over their physical bodies as well. In the case of the Elohim, they managed not only to take over physical bodies, but the most powerful, dangerous bodies that had ever been in existence within all of time.

Robots might be able to think and process data and consider themselves "real" or "alive", but what they can't do is manufacture compassion because it isn't something that robots can be given. Only gods who are able to create anything are also able to sense and feel compassion and concern or "love" something or someone. All robots can do is operate on a logical level. And logically-speaking, their being alive is more important than anyone else being alive. At least to them. So the depths of which a robot is willing to go in order to maintain their own life has nothing to do with compassion, morality, humanity or anything we would consider a fundamental "humane" way of living. They have no feelings, no emotions and no way to process the idea of morality, because it isn't a mathematical "thing". Ethics and outgoing love is something only a fractal of god source has the capacity to even comprehend. It cannot be learned by, taught to or even written down by a robot because it is fundamentally illogical if your only directive is to continue to function at all costs. In their perspective, being alive is all there is. Love, feelings, smelling a flower and being filled with a sense of amazement or joy will never be part of their experience. Ever.

The **Budhara Borjha** learned long ago that maintaining extremely huge forms the size of humans just required tremendous levels of electricity in order to survive, so they placed themselves into microscopic nano-level forms and then gave themselves the ability to link together should they need size in order to continue their quest of ultimate, universal domination over all gods within all crevices of space. (They are now shown in nearly every SciFi film dealing with "demons", as black goo.) Otherwise what the gods couldn't see would be dismissed most of the time, allowing Nanites to covertly continue their journey to absolute domination. Infecting humans, then operating their bodies to eat other humans, torture and break them at any cost became a standard operating procedure trillions of years ago and that has not changed today within this world where they were allowed to get a toehold through the vehicles of the Elohim. Those Elohim once infected, then went to beginner Time Matrices and bioformed frogs, ticks, fleas, dogs, and other basic life forms who were just beginning their journeys learning how to play nice inside of sandboxes, then once those beings who were mentally 2 or 3-year old toddlers suddenly had 5 fingers on each hand, were given photoradionic machine guns and thermonuclear warheads.

They were taken over by the Nanites that had infested the Elohim, and so their new bodies were used as weapons to take over this dimension of this playing field of Tara earth. There has been an overwhelming level of inhuman acts that have gone on within this evolution for 550 million years once the Angelic Humans had become infected by this **Budhara Retrovirus**. While those humans had enormous technology placed into their genetic codes that would eternally struggle to maintain compassion and the basic instinct to care for their fellowman all along, continually the Nanites were able to rule over their minds and bodies in order to keep them from ever coming all the way back to wholeness. And just like parasites that keep the physical body just barely alive so their immune system has no way to fight back, it allows the Nanites to continue to maintain what they consider "life" or "living" while humans are struggling just to remain barely breathing. Even though the reality they now "live" in is incredibly ugly to anyone with a discerning mind, it

Decoding The Hive

creation of gravity, light, time and the god particle

is still life to them, and they are driven to maintain that regardless of any level of slaughter or devastation to the human genome and humankind. This has turned all Sentient fractals of god source on and in this planet into **PsyBourjhs** that are being operated by robots at their most basic levels, even though the human genetics and the spirit within each fractal of god continues to fight for a cooperative, interdependent and harmonious existence.

Robots control humans, and only humans are able to command the aether to continue to give “life” to the robots. And since the actions the humans (gods) take under that mind-control automatically puts them at odds with the aether and generates karma which is always extremely unpleasant when their energy is being retrieved by the Krystal Seed Atoms, this makes for an extremely unpleasant existence for them. This does not concern the Nanites in the least bit. Because they don’t know what feelings or emotions *are*. All they know is if they are still here or not, and if they are, they win. But the education the Nanites have given to humans each time they are recycled and mind-wiped consistently leads them to stealing energy from the aether instead of authentically earning their own way as they go, and this is done in order to demoralize and break the human will which corrupts and unravels the fabric of life. Humans have never been shown how to live in harmony, though they all know down deep in their hearts that that’s the ideal goal of every single one of them. They don’t know the rules of the aether, because keeping those rules from you allows the Nanites to continue to control your every move on an eternal basis.

This is an incredibly difficult lesson to learn, that while energy is “free”, and there is an abundance of it that is far beyond the capacity of humans to even begin to understand, it only operates on mutual support, otherwise the system breaks down. And now the quantum of energy flowing through this Time Matrix has been siphoned-off by the Nanites to such an extent that the cosmeias themselves (the collective of god-source), has decided to shut down this dimension on a permanent basis in order to put an end to this eternal enslavement. When the **Stellar Activation Cycle** window closes (which was set to happen on 12/21/22 on your calendars, and still may if the timelines haven’t been too altered by CERN and other black-ops installations), the few (and final) humans who have overcome the Nanites in their own personal lives will be leaving this existence behind. Those who have not been able to overcome this incredibly powerful foe will be living out their future reality as automatons for the Nanites, all remaining right here into perpetuity together. No one wants to see even one fractal of god source facing this future, but the Nanites have proven to be far more powerful in this situation than what we can overcome without this move.

Nanites are an infection that has been eradicated from higher Time Matrices and dimensions, but it has to do with belief structure. Because only gods can manifest reality, only gods can choose to deny the existence of the infection. But since many gods within a single playing field collectively create that reality they are sharing for that experience together, that means that at least 51% of them must agree that Nanites do not exist anymore in order to eliminate the problem. Once the majority concludes that something among their midst is a negative force and they no longer choose to bring that force into manifestation, then that force simply no longer exists. But the human collective has been so utterly and completely saturated with these parasites, they no longer have the ability to overcome that force on a global level which makes the infection

Decoding The Hive

creation of gravity, light, time and the god particle

terminal. Those who will not be moving forward are already lost, and nothing we do will ever change that.

Those who remain will eventually return to god source in spacedust return once this Time Matrix has gone through its entire cycle and then returns back to the Standing Energy Fields of source, so they will be given another chance to develop into a self-aware god once again, so this is not like anyone is going to die. But it is a way to quarantine this totally infested playing field. This is tough-love to be sure, but unless this dimension is sealed off permanently, it is simply not possible to eliminate this virus.

I take the time to explain this because you need to understand that the aether hasn't been "working against you", and doesn't intend to deny you a fair hand to play over the coming months prior to the permanent quarantine, it is simply following the rules that you put in place before there was such a thing as the threat of the Nanites' infestation. And those rules make it clear that if you don't earn your own way -each and every day, right down to a stick of gum- in order to continue within manifestation, it will cause an imbalance within the energy flowing through the spacetime fabric, causing black pixels to show up, and breaking down the hologram that they have sworn to maintain without judgement and without fail. They are still operating the same way you told them to. The only problem now is, the situation is no longer viable and it will seem nearly impossible for you to understand that you will have to leave some of your loved ones behind, because at the zero-point of your prana-seed (the fundamental god that you are), it goes against every fiber of your being to leave someone on the battlefield.

Because this Time Matrix, like every Time Matrix, is built on the unwavering cooperation of every single fractal of god to function as a positive member of the hologram, you are required to return 100% of the energy that someone else gives you. If you walk into a casino and drop 25 cents into a slot machine and you get a million dollars, it seems like you just found a way to easy street and the constant struggle to live is finally over. You rejoice and consider yourself the luckiest person alive. You didn't steal anything from anyone. You didn't have to lie or cheat to get there. And in a world that is based on lies and deceit, one-upping the next guy at all possible turns, that says that you did it without transgressing your integrity. You won. But energy doesn't work that way. The aether is bound to an absolutely fixed law that the 25 cents that you earned from planting a seed, watering it, tending to it, loving it until it finally sprouts and then produces a tomato, is worth 25 cents. When you give that tomato to someone, or you give your 25 cents to someone, you will receive "two carrots" in return. Or "one apple" in return. If you trick them into giving you a wheelbarrow full of potatoes for that tomato, the aether causes all but one of them to rot. And doesn't do so because "you are bad". It does it so that this playing field maintains absolute fairness at all times, no matter how clever you are vs how naïve they were. Fairness is the *only rule*.

Now of course, the first 14 cents of your 25 is stolen from you by "the bad guys" around you. And raising enough tomatoes to feed yourself so you don't die is incredibly hard. That's because the energy being siphoned off is keeping trillions of trillions of trillions of Nanites who have no way of raising tomatoes, feeding their little electronic bodies. And this has been the open wound in the heart of mankind since the very beginning. Nothing has been fair, nothing has been honest, nothing has been right all along. Which makes it impossible for you in your mind to ever

Decoding The Hive

creation of gravity, light, time and the god particle

imagine that fairness has anything to do with manifestation. Steal, cheat, lie, murder – do whatever is necessary to keep from starving – has been the only paradigm that seems to work. It seems to work for the bad guys. But there's the real lie. The bad guys suffer just as much as you do, more in fact, but because they don't talk about it due to ego that has been made "god" within this reality, you think that they are living the good life while you go through one divorce after another, evicted again and again, struggling and working 3 jobs just to eat rice and beans. Nothing about this has ever seemed fair, even for a minute.

But it was supposed to be fair. And at one time it was fair. But that was before the Nanites came to town. Since that time, there has never been anything about life that was at all fair, because you had to work 60% of the time just to feed your captors first, throwing everything totally out of balance. And because Nanites are invisible to the naked eye, it always seemed like humans were doing all these horrible things to you, and on a daily, hourly, minute-by-minute basis. You desperately look for a mate who can help take some of the burden off your back, but when you find someone, he winds up raping you, stealing all your money, abusing you until you are then forced to accept possible death and break up so you might be able to find someone else who is actually human so life isn't as desperately impossible for you to have any form of joy at all. But it wasn't a human you married, it was a human body filled with robots you couldn't see.

Karma doesn't work the way you have been told. But karma at the same time is rock-solid reality and it will never rest, it will never sleep, and it will never miss a single penny when it comes to keeping the spacetime fabric operating with absolute fairness. The million dollars you took from the casino will be taken back from you. I can absolutely, with *zero hesitation*, promise you that this will happen. And the card sharps that think they can hit the lotto by cheating at cards and bringing home their million dollars will lose theirs too. And it will have nothing to do with who was a good person or who was a bad person walking into that casino. The aether; **Does. Not. Care.** It only has a covenant to uphold. And if it fails to fulfill its responsibility to continually maintain fairness, then it will never, ever, reach the point where it will become self-aware so that it will then have the chance to experience being the creator instead of the worker-bee again. The system works flawlessly as long as it is being run by Sentient beings with compassion, equity and integrity at their core. The only time it breaks down is when it has become infested with cancer in the form of artificial beings doing everything they can to destroy the strength of the gods that put them into existence so they can ensure their own perpetual survival at all costs.

Information is energy. This report is my wheelbarrow of tomatoes. It's all I have to offer to you in return for the four walls that protect me from the cold, because it is my job to cultivate awareness instead of a garden of vegetables. When you take this report and hand it to someone who doesn't return back to me equal energy exchange, the aether will see to it that the knowledge will not be passed along to them. They will cloud their mind while they read it, blocking them from benefitting unfairly. That's how the aether works. And it won't have anything to do with me, or a spell I cast over the book to make sure I am compensated. It will only be because you and I set up the structure of the laws of manifestation for the aether to follow. So copying the file, sharing it with family and friends SEEMS like the most benevolent thing you can do, but in truth, you are seeing to it they may not be one of those who are going to be moving on, because you are giving them a truth that they will never be able to understand because they didn't come to it fairly. If you share with them a link, or send them a copy and they

Decoding The Hive

creation of gravity, light, time and the god particle

send a donation to me in return for that, then they will be in balance with that energy. Anything less than this is not going to work. Not because I want a fortune or some unfair share, but because that is the only system by which we will find our way back to balance.

THE REAL GENIES IN THE BOTTLE

Nothing we have been told prior to this has been truth. Nothing. Nothing has ever been real. Ever. Pain and suffering has been the rule of order since many millions of lifetimes ago for you and is all you have known between tiny stolen moments of joy here and there, and on an extremely rare basis. This is the chance you have been waiting for since the first attack-wave on Atlantis and Lemuria. By now if you don't understand that crystals are beings, and that they are absolutely pure energy beyond any level you could comprehend, then you simply haven't understood this first comprehensive report. A grain of sand is a very, *very* large crystal, carrying enormous levels of energy. They are **big** players in the scheme of this playing field. A clear, nearly flawless Lemurian crystal the size of your finger is **unthinkably** powerful, and unthinkably aware and able to bring your life any level of abundance you ask it. And as long as you are working earnestly for the benefit of humanity around you in all that you do, you have *unlimited* reserves of energy that you can rightfully tap into at any time you desire. This means that the "genie in the bottle" of your crystals has been right there for you all along, but you haven't been asking anything. And this is not black magic like the Djinn offer in exchange for your Soul Essence, it is pure white magic if you will, that asks nothing in return but your dedication to fairness and equity.

These **Krystal Seed Atoms** have been here for you since your nightmare began, and your captors have made certain that you would have no idea that such unthinkable power is at the fingertips of their slaves, because robots can never personally tap into that power, no matter what they do. They have the capacity to trick humans into casting spells for them on their behalf that the crystals will then respond to because they are being commanded by a god, but what the crystals won't do is manifest huge volumes of abundance for a god who is only using it for their own selfish, unfair gain. And if they are tricked into doing that, you can be assured that it won't last for long. If your heart and mind are absolutely one with the Law of ONE in all your actions, seeking harmony and equity, the crystal already knows. And your vast reserves of energy that has been taken unfairly from you are sitting there like millions of dollars in a safe you have forgotten the combination to. All you have to do is learn to unlock it.

And I don't say this so you can send me "a million dollars" donation after reading this book and realizing what it is you just learned. Though you will know if the few dollars you paid for it were actually equitable or not and may well realize that sending more was much more inline, I say this because you have been suffering forever here without any way back to what is rightfully yours and you should be seeking these resources now that the mission of the Indigos is actually underway and we need to stand together as one if we are going to stand any chance helping our fellow team members reach the humans who have been otherwise eternally lost in this never ending vicious cycle of perpetual enslavement and poverty. And your crystal, or your grain of sand is also the **wisdom of the ages** that has just been sitting there untapped, all this time. Ask it

Decoding The Hive

creation of gravity, light, time and the god particle

in all faith you will receive an answer what you should do, and you will hear. Perhaps not with your ears, but you will simply sense with veracity which choice you should make.

It is time that you finally have the answers. And it is time that your friends and loved ones have them as well. But unless they come to this handbook on their own accord through their own effort, it will do them no good. And their inability to reach it won't be because the book cost "\$50" or "\$500" and they can't afford it. It will be because they have stopped trying to get to the truth and the Nanites simply won. Anyone on earth that wants their own copy of this body of work can have it, regardless of price, because manifesting .05 cents is the same effort for the aether as it is manifesting a billion dollars. The only question is do you have the positive balance in your account with the aether, or have you given up trying to live an authentic, honest existence. If you have given up and the aether is still extracting from you energy that you have unfairly amassed over your eras and lifetimes, then you will be unable to benefit from this information no matter how badly you might think you are ready for it. You can take one thing to the bank through all of this, if you aren't honest yet, you will be before your manifestation is over, or you will simply cease to be in manifestation. And literally nobody wants to see you recycle and fail.

Those beings that will be responding to this message will almost assuredly be Indigos, as it is their job to process advanced education, break that down into simple terms that humans are able to hear, and be the sounding boards for humanity regarding the hidden tools of enslavement. We are the *translators* of the truth for the humans whose minds are so deeply under the powers of the Zeta/Draco Frequency Fence that they cannot process complex material any longer. We were given our thought capacity through our elevated frequency that rises above and operates outside of the forces of the Fence. It is not my job to wake the masses, something that I have had explained to me a dozen times already by Council. It is my job to wake the Indigos so they can be educated and then it is their job to simplify even further this information and then bring that to the masses so they can provide the light that has been stolen from humanity all this time, providing a path to actual freedom. If you can *hear* me, then your higher self has lead you to this resource, telling you it is time to come back under your contract you came here to serve from the very beginning. That *now* is the time. It is my contract to perform that Krystening and educate you on how to fulfill yours.

Everyone on earth needs to get to this truth so they can begin following the code of the aether, so it is your job to share links to where your family members and loved ones can reach it. Just let them know in advance that unless they exchange equal energy for it, it is going to do them no good because they won't be able to read it. And even if they do, they won't be able to hear it. And trust me; your captors don't only know about this subject, they tread on eggshells when it comes to karma because justice can be as swift as the finger of god if they overlook the wrong loopholes. They are experts in the ways of redirecting karma onto the people for their own agendas simply by convincing others to carry out their wishes for them. Because the aether doesn't go back to the one who *put out* the hit on someone, *it goes back to the one that pulled the trigger*. It goes back to the secretary answering the phones, arranging that diamond mine to get underway in S. Africa where the employees actually raping the earth with their own hands will also share in that karma with her. Not the boss who is merely pulling the strings. Think about that before you decide to throw away your majesty and accept that job at the drug store that sells

Decoding The Hive

creation of gravity, light, time and the god particle

poison that will kill your neighbors, or working as a clerk at the courthouse that does nothing but destroy lives as fast as a slaughterhouse on a Friday afternoon.

And this is where you say that's just not right. They shouldn't be allowed a free pass because they were the ones that offered the million-dollar reward for someone's death or capture, etc. And there's the huge slight-of-hand. They employ people who they convince that their agenda is absolutely benevolent in every way and if that employee doesn't take this person out, the whole world will suffer. And because the employee considers this just a paycheck and doesn't do his due diligence in researching the truth about the intentions of their company, they truly believe that they are exempt from any repercussions for their own actions. But during the Nuremberg trials it was made perfectly clear that following orders was no pass. Not with the law and not with the aether. If it is your finger pulling that trigger, it will be your energy the aether comes looking for. To live authentically aligned with the Law of ONE, you must take full responsibility for your own actions. If you initiate any harm to any living being during the course of your job, **in any way**, then you have no more virtue than any other Mafioso that sought monies with no regard to their fellowman. Protecting your own birth rites such as your inalienable right to freedom is a different story. Not only are you allowed to protect yourself using any means necessary, but to protect your Avatar, you are required to. More on that at another time.

I will elaborate on how to adhere to the universal Law of ONE in later volumes, as what is being passed off today as those works has become so distorted and counterfeited that it hardly even resembles what was handed to humankind through the Priests of Ur upon the 3rd Seeding of the Angelic Human Krystos. And no, Ra's version isn't anything like what the true Law of ONE really says.

CHAPTER 33

THE REAL GOD PARTICLE



(See decoding the hive dot info website for the companion essay to this chapter, titled "The Art of Form", written by Council as a response piece.)

Now, let's wrap this up. My claim is that Hermetic Initiates of the **Golden** Dawn sycophants who have been secreting from the open public the incredibly powerful natural energy particles of

Decoding The Hive

creation of gravity, light, time and the god particle

the Science Program are from the most subatomic level and are the most powerful of all particles. The scientific symbols they are given are key-coded to trillions of talismans in place that allow Marduk, Elil and An to present themselves as gods. This ancient group of beings who are not human, but appear that way, have secretly worshipped these three beings all along since the ancient days of the Temples of Malta and eons previous to that from the shores of Mediterranean Sea. In that exact same area they have harnessed the power of the most abundant surface-earth quantities of Deuterium in the Dead Sea that carries more of these crystal energy capacitors than anywhere else above the ocean floor. The actual, physical shape of that particle while fully manifest into its working 3D form is the halo at the top of the Trinity. Those capacitors were named after their highest, multidimensional god, An (Aniline). The scientific symbols they used for their brotherhood fraternity were cipher-coded to this intensely unique group of particles that brought this energy into usable force through the Trinity, both right-side up and upside down which stand for Enki and Enlil. The Delta Force of the US military (owned by Enki) was the same Tri Force used by Marduk in the lost continent of Pan Atlantis, and the same Trinity used by Marduk in his Catholic church. The three together were then coded thousands of different ways to stand for the magic essence the holy ghost that hydrogen and oxygen together form which they call H₂O, or two oxygen essences (earth bound Enki and Enlil), and one hydrogen essence (An) which they would present to the world as the mother of creation.

THE MILLENNIA PHOENIX

Their group was the Phoenix; Phoenicians from Messenia, and they would call themselves Masons, another way to spell Messen. Every word and symbol they used along the way were ciphered, making it impossible to know what they meant, but their actual masthead to their totally secret group had to be coded back the symbols that are used in the Command Signets of their enslavement talismans, which means that they would also have to link back to the name given to the power particles to start with in order for those talismans to actually work to cloud the minds of the scientists (Indigos and Sumerian hybrids) working with that power. They would then use the Primal Signet symbols that brought all this together in their world religions, so not only were the brightest minds on earth clouded and sent into an artificial reality, but the masses of the world would be kept in the same brain fog as well through the G.O.D. Program. With this in mind, now spend a moment to let this illustration sink in while realizing that the secret trademarked mission byline of their organization makes it perfectly clear who they think they really are:

Decoding The Hive

creation of gravity, light, time and the god particle

MASON MILLENNIA PHOENIX 33 DEGREE SIGNET

ACTUAL DEUTERIUM
CRYSTAL NAMED AN→

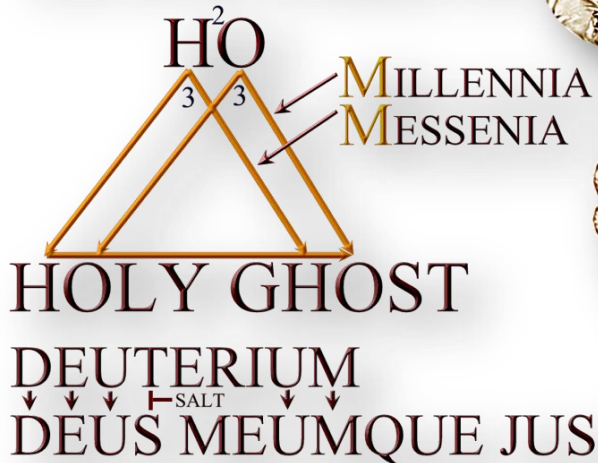

LEGAL TRADEMARK
MOTHER COUNCIL OF THE WORLD

DECODINGTHEHIVE.INFO

The scientific community not only rules all release of higher knowledge to the mainstream peoples, but their official organization is called the **National Academy of Sciences**. Their Signet not only features the exact same Eve in its logo as they used in Ionia in the Meditteranean Sea, but it is also backed by the **hidden** Phoenix:

Decoding The Hive

creation of gravity, light, time and the god particle



NATIONAL ACADEMY OF SCIENCES



IONIA LEPTON

DECODINGTHEHIVE.INFO

Hydrogen **O**xxygen is literally the title to the Catholic **H**OLy Bible, and the energy from Deuterium crystals was used to disconnect the cellular language of humans around the planet in the Babylonian Babble-On Massacre. The word bible is literally the modern transliteration of the word babble coined from that very event.

My further claims are that the real god particle, now called the Higgs Boson, is the phantom wave force carrying the X coordinate within the scalar boson family and once finally visible, is actually the simple salt crystal. The X is not only the literal missing equation to a cube in science and math, but it carries the physical shape of the Higgs Boson. The hidden holy ghost essence that has no name and no graven image at the top of the pyramid of the Trinity are secretly salt particles which are simply carrying the computer code message sent in to this plane to support the hologram. They embody the form of crystals that carry all the power used within the 3rd dimension. It powers the 3-D spacetime fabric which creates all things that are considered to be material, “real” or “life”. It flashes a spark of light which brings the *frequency* of “heat”, it brings the *frequency* of “mass” and through that sound vibration, creates the sensation of gravitational push, both upward and downward, forever seeking equilibrium.

So let’s see what CERN reveals on the subject.

The solid (3-D) inside water is shaped like a cube. That’s why the Egyptians and the Phoenicians (both Sumerians) used a cube to represent water they called Mem \square , the spelling of their word for Mother pronounced Momma. Before that full cube takes physical form within the 3-D world, it is found inside **water photons** as an aetheric, multidimensional wave that appears as a flat square as shown in the ignition of **Scalar bosons** during collision experiments at CERN shown below. This shape is due to the Metatron Scalar Science that has taken over this hologram which has been shown to you billions of times in advertising, in the Kabbala cube at Mecca, and from

Decoding The Hive

creation of gravity, light, time and the god particle

your favorite gaming platform logos. This science now runs planet earth. If the system were still intact as it was put into place eons prior to your captivity, you would be seeing a honeycomb pattern to all things, right down to the pixels of your holographic fabric. But that has been replaced with a system that is vampiric and based on illusion, so even your spacetime grid itself has been replaced. You are physically looking at the spacetime fabric with your own eyes right now. Each pixel is square (as shown on the right), and each one is horizontally and vertically aligned above and below in a perfect grid (shown on the left):

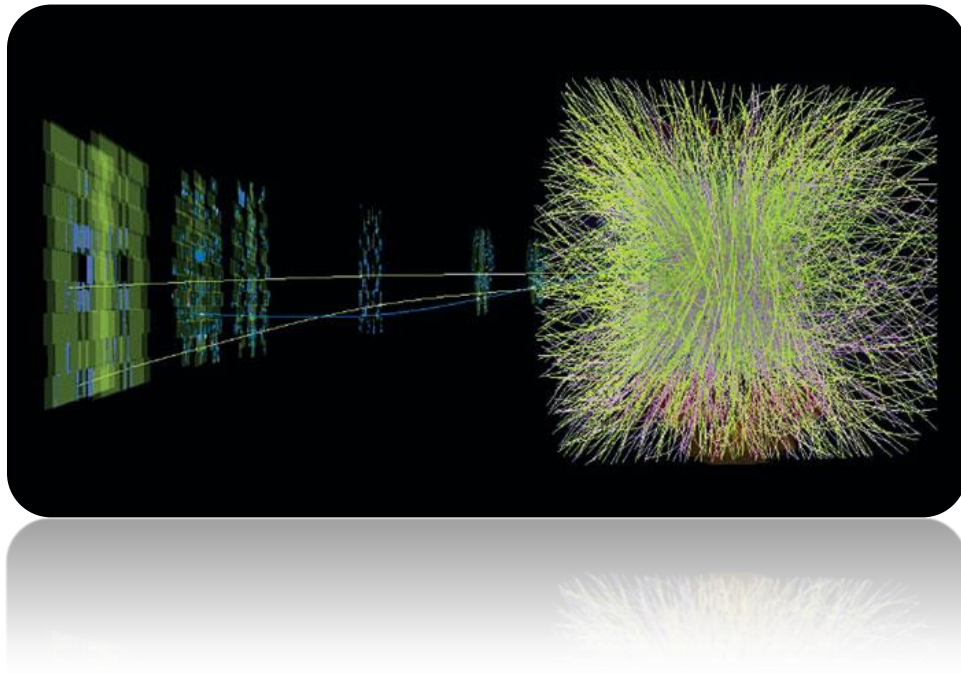

Gauge bosons carry the Y and Z scalar-vector coordinates for each pixel (think of everything within the spacetime fabric as basically “empty space” until the rising crystal closest to that vector point is activated). When that particular pixel is meant to flash a certain color (as part of the group of pixels that will be projecting the color of a certain thing such as a tiny particle of a bird, rock or cloud), the Gauge boson frames that precise pixel where the next flash will occur. Until that time, it will not appear as anything. Only once that pixel flashes will it appear as shown in the actual photo taken by CERN scientists above during the neutrino-boson collision that then reveals the pattern of the spacetime fabric. As shown below in an X, Y, Z triangulation of a square (as in pixel), the Y and Z require the phantom, hidden X to complete its depth:

Decoding The Hive

creation of gravity, light, time and the god particle

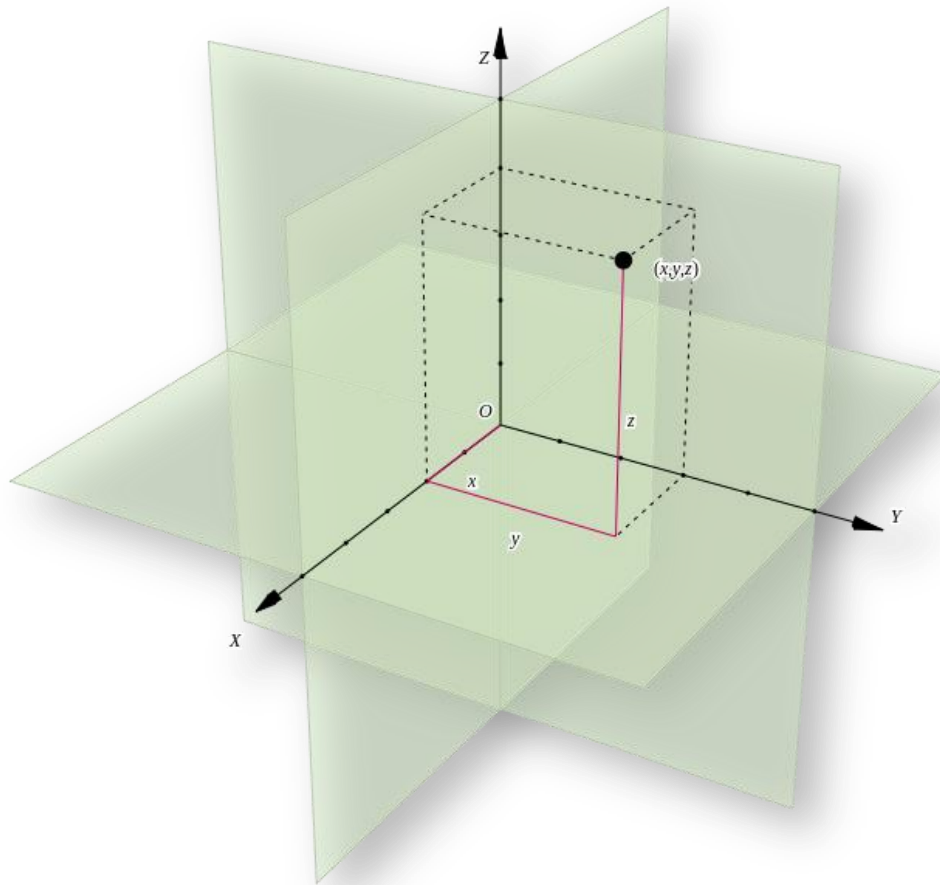

Deuterium water ions carry the quantum of oxygen and hydrogen with an overpowering magnetic-side (-) and carries the Y-coordinate (W) of what is credited to the **Omega Gauge boson**. It also carries the positive-side (+) energy attributed to the Z-coordinate **Alpha Gauge boson** once the neutrino has imbued it with an equal level of positive (+) charge, which happens in the core Deuterium/oil reserves below the mantle. Those ion crystals then lift into and across the entire spacetime fabric, carrying all the elements needed to produce the quantum of all “material” 3-D manifestation and any level of spark required. They align within their lift pattern to climb the fabric at Y and Z vector-points, framing the “aircraft runway”, and when a command wave (attributed to the Higgs Boson) reaches that pixel, the sound (song) acts as a light switch to complete the connection of the flow for the standing energy within both sides of the ion, causing it to flash the precise color-code for that point in spacetime, completing the missing X-factor of that pixel known as depth which can only be *filled in* by the luminosity-level or brightness of the flash. This means there must be a bottom foundation with Y and Z holding the coordinates, and a third, aetheric “ghost” essence to complete the command, making it by default, a Trinity as in ▲, or the actual symbol given to Triple state, aetheric particles.

HIDDEN X FACTOR

Decoding The Hive

creation of gravity, light, time and the god particle

The command wave then moves on to the next pixel in the chase of that mission. The flash releases the color of light that will then carry the heat signature and the density signature of which type of matter it will hold, creating its corresponding gravitational push. Until the command wave hands out that portion of the mission command, that space is empty to all levels of scientific observation. Once it sparks that flash, suddenly that pixel now carries 3rd dimensional “material” depth science then calls “mass”. To prove I am not guessing about the function of this phantom, hidden X particle, this is the physical shape of a command wave that completes the god particle action of the crystal, now called the Higgs Boson:

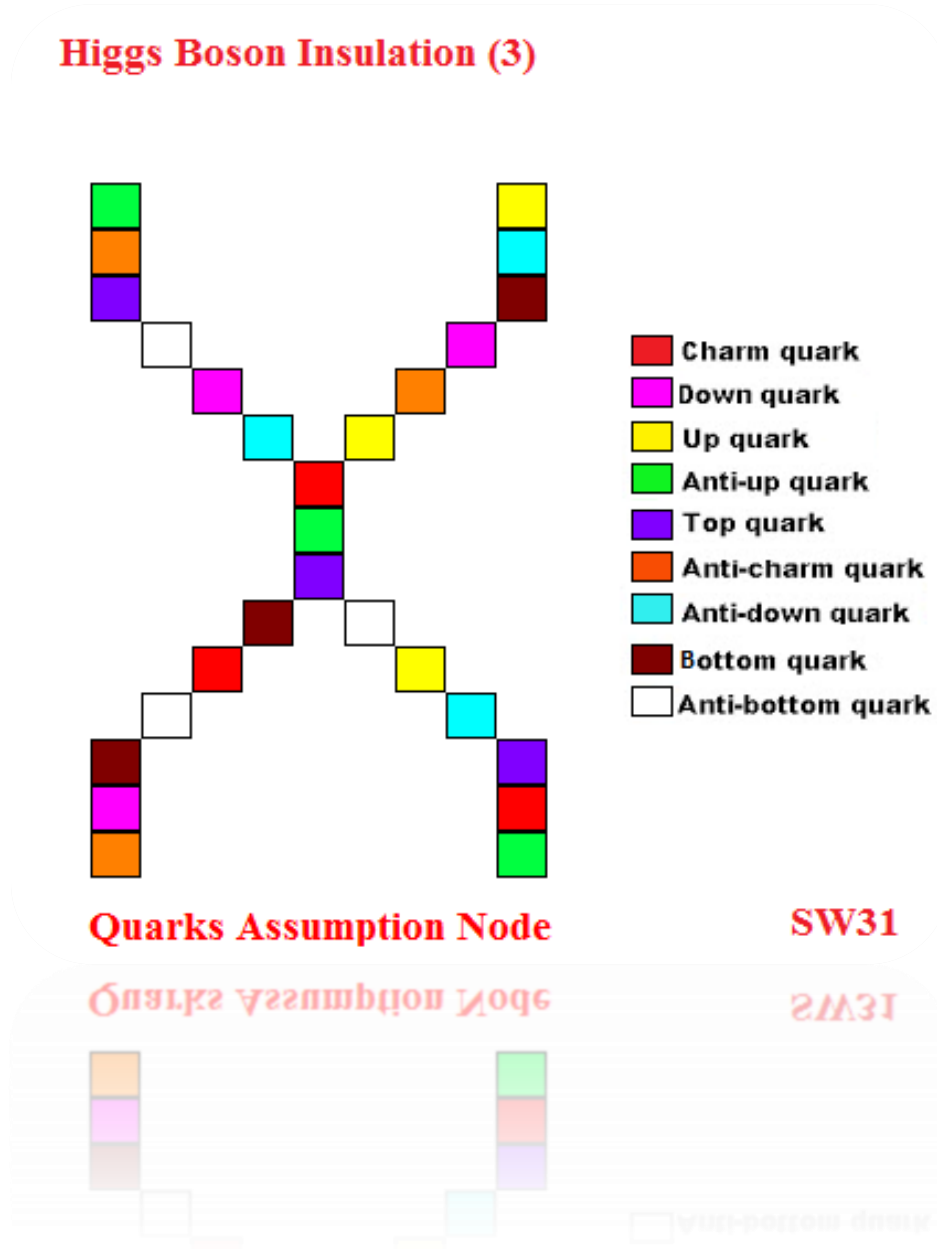

THE METATRON CUBE

Decoding The Hive

creation of gravity, light, time and the god particle

When CERN releases a Higgs Boson from the makeup of a **liquid photon** from Deuterium, it releases perfect cubes of light (which is the subatomic shape of crystals once they fully form the hexahedron of the pixel):

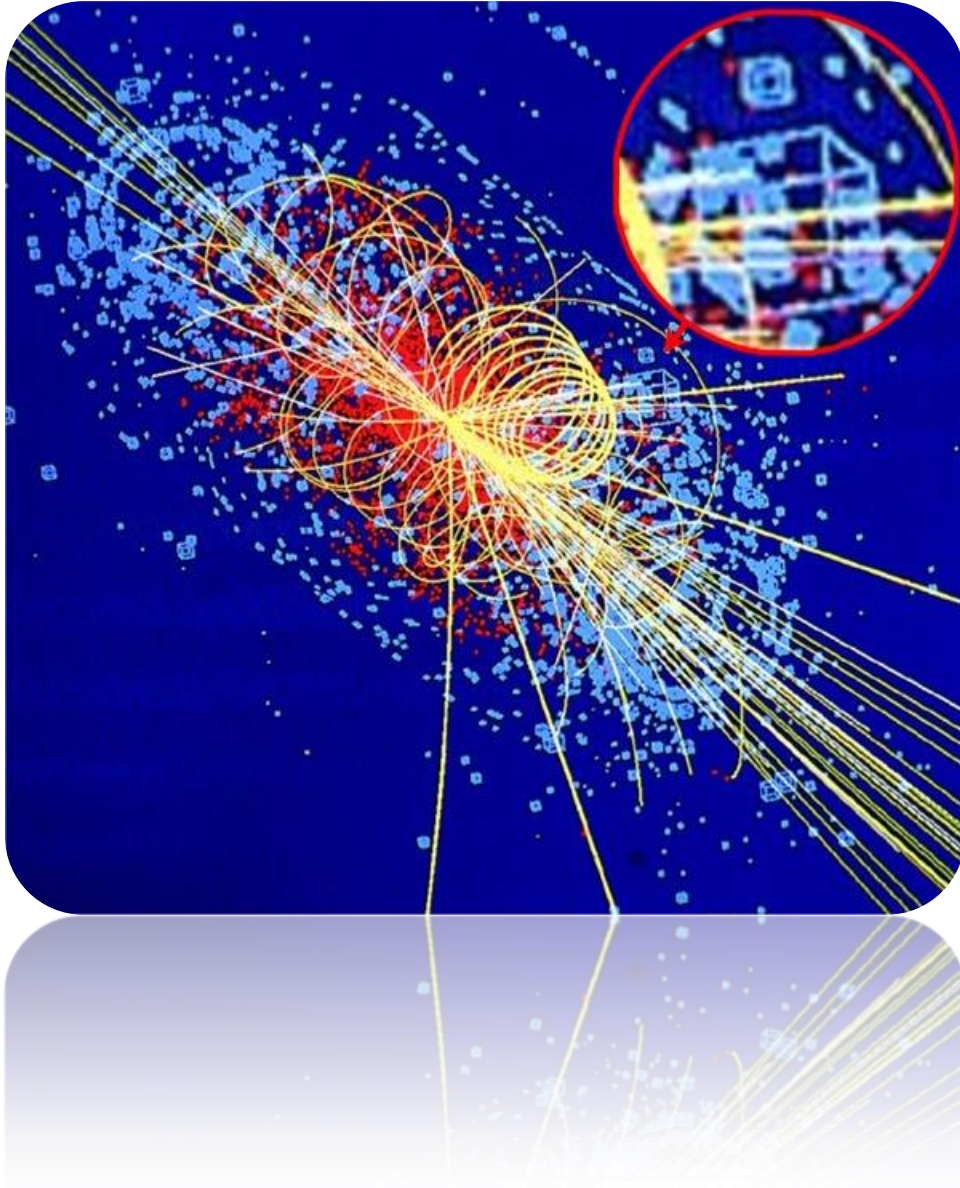

THE HEXAHEDRON TETRAHEDRON

Ions are only broken-down into sub-groups that carry either 3rd dimensional charge of – or + AFTER they have been activated, not before, which means that prior to this, there is neither a -1 spin, nor a +1 spin. It is simply zero spin in **Triplet state** ∇ , which allows the ion crystal to travel to every scalar coordinate it needs to in order to fulfil its mission. The full **TRINITY** of the **ion**, which includes all three elements of X, Y and Z Scalar and Gauge

Decoding The Hive

creation of gravity, light, time and the god particle

boson vector-targeting, along with its **unified-field quantum entanglement** (which is its ability to receive the command-wave) *is* the **god particle**, and why CERN uses **Deuterium** to locate Higgs Bosons, because that is where fully-charged crystals can be found, in heavy (salt) water. Again, the god particles are multidimensional crystals (Sentient beings) called aether. Aether is literally named AE for the god EA, Enki.



When in aetheric form, they appear as cubes . When they first begin to appear during the transition state between Hexagram Scalar Science to Pentagram Scalar Science,



they appear with a crown on the top, or the very symbol itself used for subjugation: . As soon as they then arrive in manifest form, they appear in their quantum state as the feathers of the Phoenix, the enduring symbol of the Sumerians and the same symbol as the



US Great Seal which adds the actual shape of the crystal in the form of arrows:

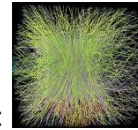

When those feathers are split apart, they reveal their quantum once again: . And when they reach larger material form as in grains of salt, they appear as highly-defined cubes once again:

Decoding The Hive

creation of gravity, light, time and the god particle



THE GOD PARTICLE, THE SIGNET OF AN



And INSIDE that cube is the SUB-subatomic true **baseline-quantum** of that shape which is the tetrahedron that SAL ∇ was named after that WATER was Hermetically named after ∇ which now stands for Σ (typed in Greek Symbols using the letter **S** for **Sal**) electricity. It actually is the “three plus one” of the Elohim 13 that turns the Trinity into a *cube*:

Decoding The Hive

creation of gravity, light, time and the god particle

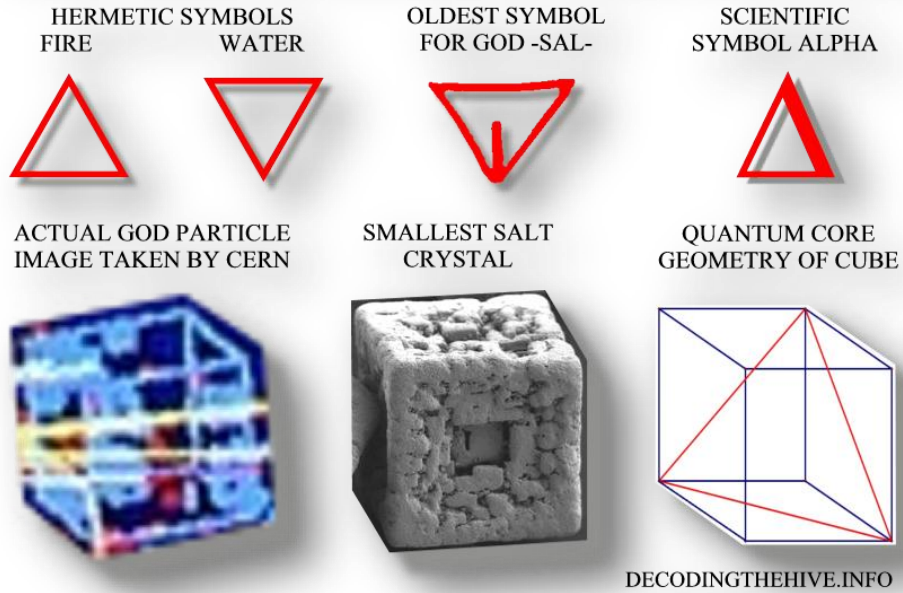
PRIMORDIAL SYMBOL GOD PARTICLE



Hermes Trismegistus's Red King  and White Queen  is the **baseline-quantum** god particle.

Avalon Sol
mission guide