

Fig. 1

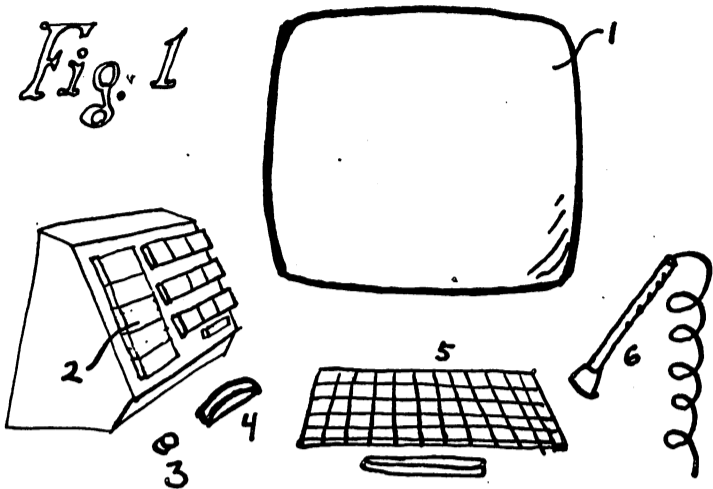

Fig. 2

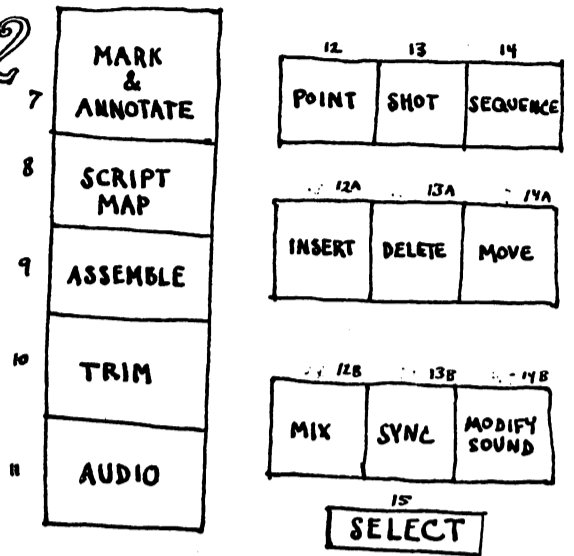
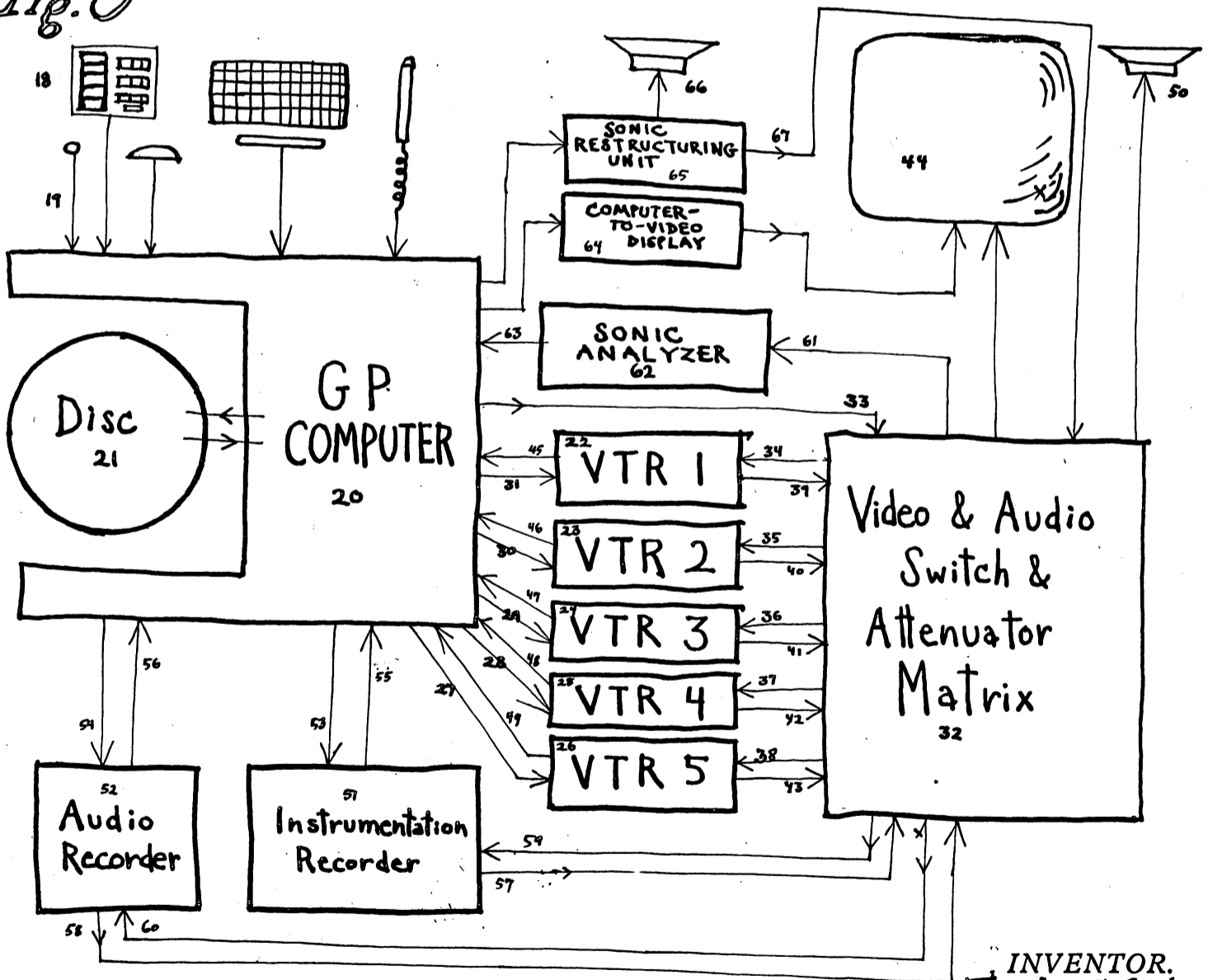
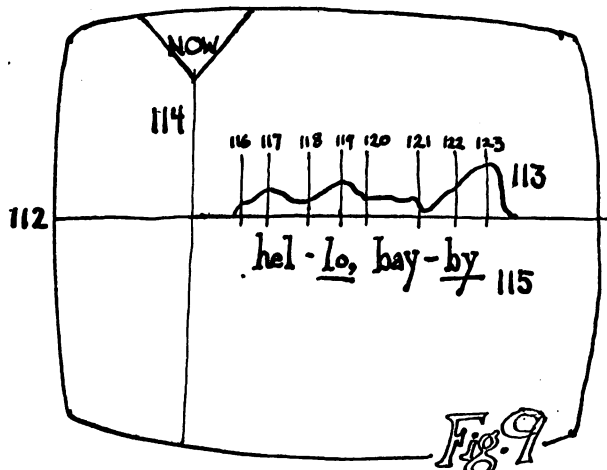
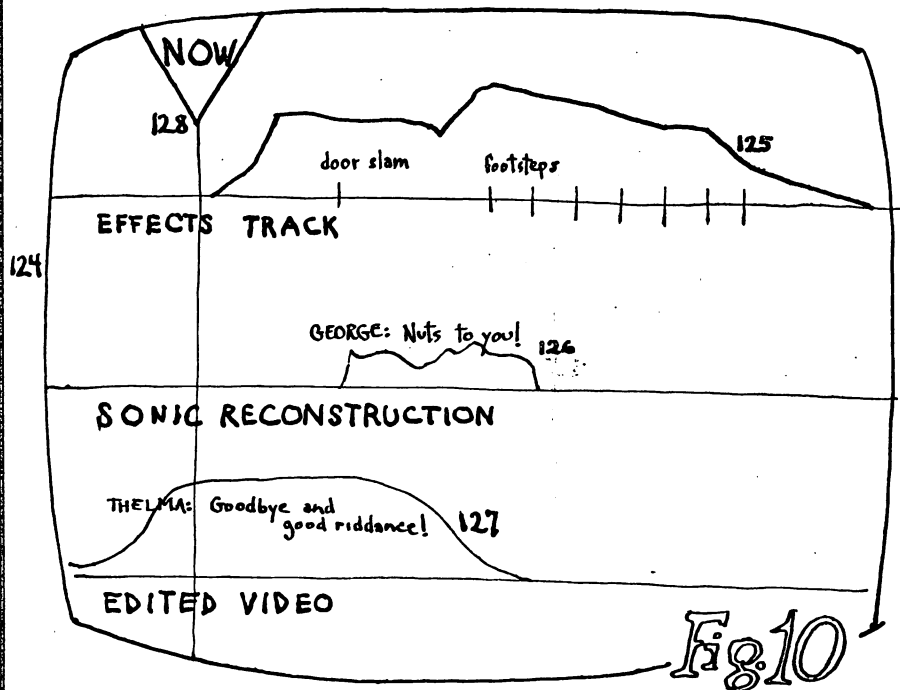
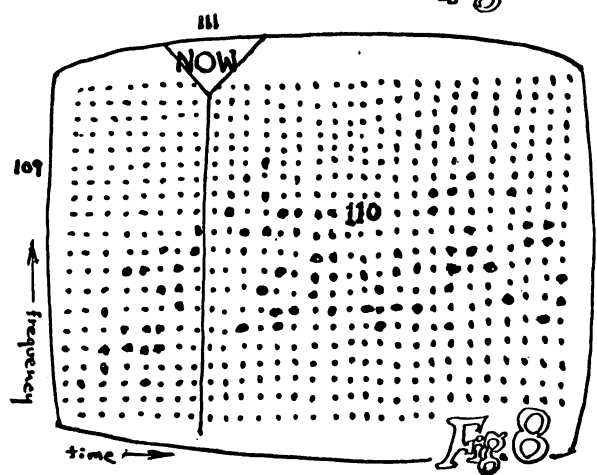
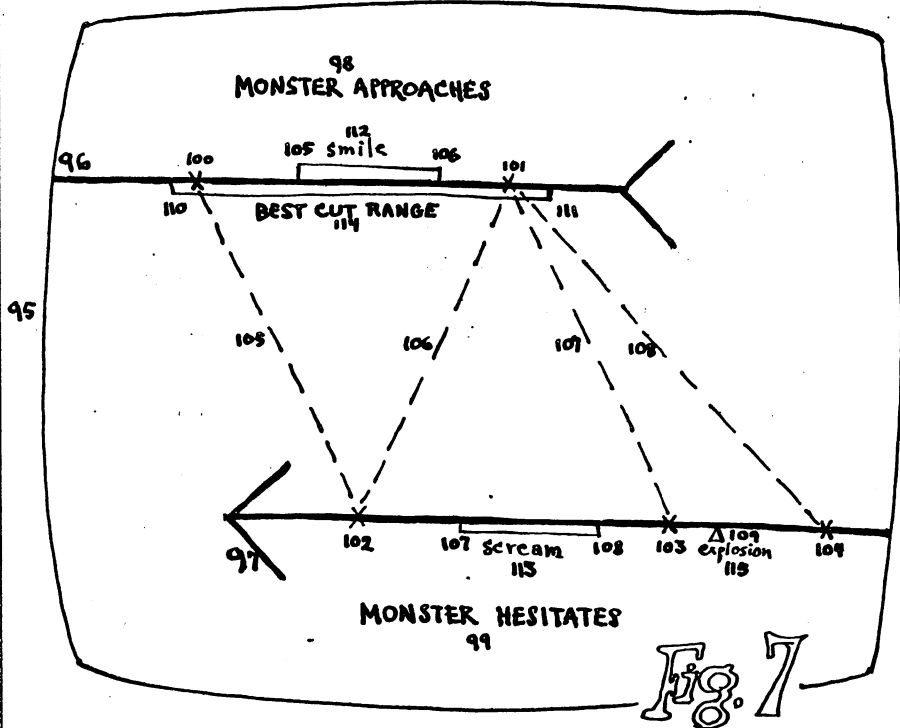
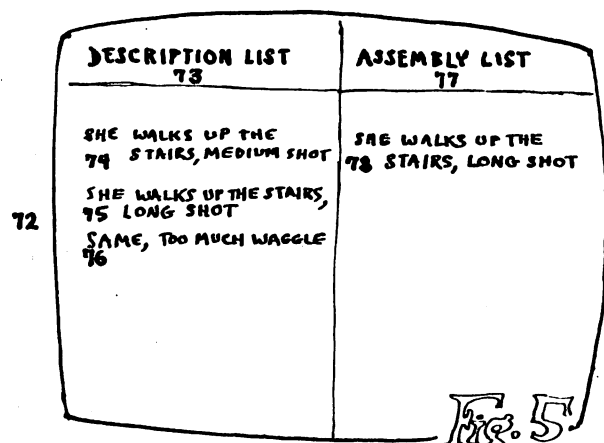
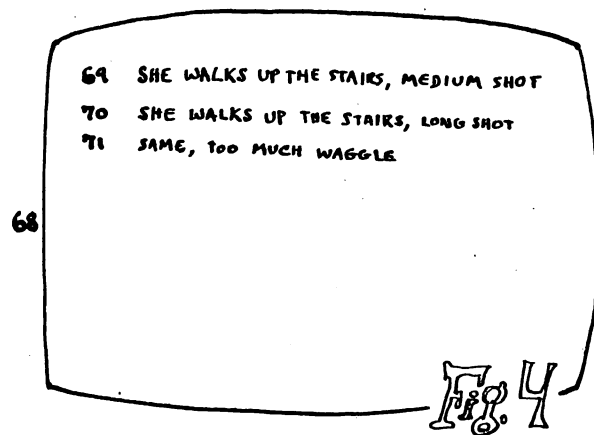
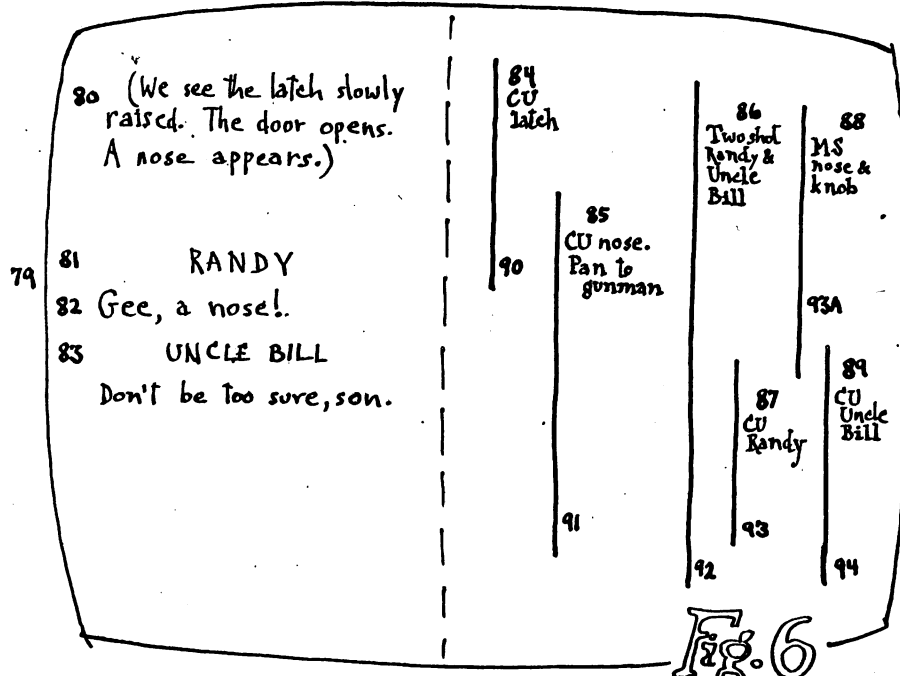

Fig. 3



INVENTOR.
Theodor H. Nelson

BY



INVENTOR.
Theodor H. Nelson

BY